

R&S® SMBV100B

Vector Signal Generator

User Manual

 海洋儀器
致力于电子测试、维护领域!



Contents

1	Preface	23
1.1	Key Features	23
1.2	For Your Safety	23
1.3	About This Manual	24
1.4	Documentation Overview	25
1.4.1	Getting Started Manual.....	25
1.4.2	User Manuals and Help.....	25
1.4.3	Service Manual.....	26
1.4.4	Instrument Security Procedures.....	26
1.4.5	Basic Safety Instructions.....	26
1.4.6	Data Sheets and Brochures.....	26
1.4.7	Release Notes and Open Source Acknowledgment (OSA).....	26
1.4.8	Application Notes, Application Cards, White Papers, etc.....	27
2	Getting Started	28
2.1	Preparing for Use	28
2.1.1	Putting into Operation.....	28
2.1.1.1	EMI Suppression.....	29
2.1.1.2	Unpacking and Checking the Instrument.....	29
2.1.1.3	Accessory List.....	30
2.1.1.4	Placing or Mounting the Instrument.....	30
2.1.1.5	Connecting AC Power.....	32
2.1.1.6	Turning the Instrument On and Off.....	32
2.1.1.7	Functional Check.....	34
2.1.1.8	Default Settings.....	34
2.1.1.9	Checking the Supplied Options and Licenses.....	35
2.1.2	Linux Operating System.....	35
2.1.3	Connecting USB Devices.....	36
2.1.4	Setting Up a Network (LAN) Connection.....	37
2.1.4.1	Connecting the Instrument to the Network.....	37
2.1.4.2	Using Computer Names (Hostnames).....	38
2.1.4.3	Assigning the IP Address.....	39

2.2 Instrument Tour.....	40
2.2.1 Front Panel Tour.....	41
2.2.1.1 Touchscreen.....	41
2.2.1.2 Keys.....	43
Utility Keys.....	43
On/Standby.....	43
Function Keys.....	44
Keypad.....	44
Editing Keys.....	44
Navigation Controls.....	45
2.2.1.3 Connectors.....	46
2.2.2 Rear Panel Tour.....	47
2.2.2.1 Connectors.....	48
2.3 Trying Out the Instrument.....	51
2.3.1 Generating an Unmodulated Carrier.....	52
2.3.2 Generating a Digitally Modulated Signal.....	53
2.3.3 Triggering the Instrument with an External Signal.....	56
2.3.4 Enabling and Configuring a Marker Signal.....	60
2.3.5 Verifying the Generated Signal with the Graphics Display.....	61
2.3.6 Saving and Recalling Settings.....	64
2.3.7 Generating an EUTRA/LTE Signal.....	67
2.4 System Overview.....	70
2.4.1 Brief Introduction to the Instrument's Concept.....	70
2.4.2 Signal Flow at a Glance.....	70
2.4.3 Internal Baseband Source ("Baseband" Block).....	71
2.4.4 Digital Baseband Input ("BB Input"Block).....	72
2.4.5 Additional White Gaussian Noise ("AWGN" Block).....	72
2.4.6 "I/Q Stream Mapper" Block.....	72
2.4.7 I/Q Modulator ("I/Q Mod" Block).....	72
2.4.8 Analog I/Q Output ("I/Q Analog" Block).....	72
2.4.9 RF and Analog Modulations ("RF" Block).....	73
2.4.10 Applications Examples of the R&S SMBV100B.....	73
2.5 Instrument Control.....	73

2.5.1	Possible Ways to Operate the Instrument.....	73
2.5.2	Means of Manual Interaction.....	74
2.5.3	Understanding the Display Information.....	75
2.5.3.1	Status Bar.....	75
2.5.3.2	Block Diagram.....	76
2.5.3.3	Taskbar.....	77
2.5.3.4	Additional Display Characteristics.....	78
2.5.4	Accessing the Functionality.....	79
2.5.5	Entering Data.....	80
2.5.5.1	Entering Numeric Parameters.....	81
2.5.5.2	Entering Alphanumeric Parameters.....	81
2.5.5.3	Undo and Redo Actions.....	81
2.5.6	Getting Information and Help.....	82
2.5.7	Remote Control.....	83
2.5.8	Remote Operation over VNC.....	84
3	Configuring the Internal Baseband Source.....	85
3.1	Overview of the Signal Generation Modes.....	85
3.2	How to Access the Functions in the Baseband Domain.....	86
3.3	Generating Signals According to Digital Standards.....	87
3.4	Common Functions and Settings in the Baseband Domain.....	89
3.4.1	Basics on Signals, Modulation Types and Filters Used the Baseband Domain.....	89
3.4.1.1	Data, Clock and Control Signals and Sources in the Baseband.....	89
	Internal Modulation Data.....	90
	Clock Signals.....	91
	Control Signals.....	92
3.4.1.2	Regular Marker Output Signals.....	94
	Marker Modes.....	94
	Delaying Marker Signals.....	96
3.4.1.3	Baseband Trigger Signals.....	96
	Trigger Sources.....	97
	Impact of the Trigger Modes on the Signal Generation.....	97
	Impact of the Additional Trigger Settings.....	100
	Receiving and Providing Trigger Signals.....	103

3.4.1.4	Supported Modulation Types.....	103
3.4.1.5	Supported Coding Schemes.....	104
3.4.1.6	Supported Baseband Filters.....	105
	Impact of the Filter Parameters.....	106
3.4.1.7	Methods for Optimizing the Crest Factor.....	107
3.4.2	Common Settings.....	109
3.4.2.1	Trigger Settings.....	110
3.4.2.2	Marker Settings.....	113
3.4.2.3	Clock Settings.....	115
3.4.2.4	Global Connector Settings.....	115
3.5	Generating Custom Digital Modulated Signals.....	116
3.5.1	Required Options.....	116
3.5.2	About the Custom Digital Modulation.....	116
3.5.3	Custom Digital Modulation Settings.....	116
3.5.3.1	General Settings.....	117
3.5.3.2	Trigger, Marker and Clock Setting.....	119
3.5.3.3	Data Source.....	119
3.5.3.4	Modulation Settings.....	121
3.5.3.5	Filter Settings.....	124
3.5.3.6	Power Ramp Control Settings.....	126
3.5.3.7	Data List Editor.....	128
3.5.3.8	Control and Marker Lists Editor.....	130
3.5.4	How to Create Data and Control Lists.....	134
3.5.4.1	How to Create and Assign a Control List.....	134
3.5.4.2	How to Create and Assign a Data List.....	136
3.5.5	References.....	137
3.5.5.1	Common Coding Algorithms.....	140
3.5.5.2	Predefined Baseband Filters.....	142
3.6	Using the Arbitrary Waveform Generator (ARB).....	145
3.6.1	Required Options.....	145
3.6.2	About the ARB.....	145
3.6.2.1	Waveform Files Sources.....	146
3.6.2.2	ARB Test Signals.....	146

3.6.2.3	Waveform Sample Rate.....	148
	Impact of the Resampling Filter.....	148
	Impact of the Oversampling Factor.....	148
3.6.2.4	Impact of the Enabled Number of Marker Signals on the Waveform Length.....	149
3.6.3	ARB Settings.....	150
3.6.3.1	ARB General Settings.....	150
3.6.3.2	Sine Test Signals.....	154
3.6.3.3	Rectangular Test Signal.....	155
3.6.3.4	Constant IQ Test Signal.....	157
3.6.3.5	Trigger, Marker and Clock Setting.....	158
3.6.4	How to Generate and Play Waveform Files.....	159
3.6.4.1	How to Create and Store ARB Test Signals.....	159
3.6.4.2	How to Create Waveform Files with the Built-In Generate Waveform File Function...	160
3.6.4.3	How to Load and Play Waveform Files.....	160
3.6.4.4	How to Create a Waveform File with the R&S WinIQSIM2 and Load it in the ARB....	161
3.6.5	References.....	166
3.7	Generating Multi-Segment Waveform Files.....	167
3.7.1	Required Options.....	167
3.7.2	About the Multi-Segment Waveforms.....	167
3.7.2.1	Multi-Segment Waveforms Processing.....	168
3.7.2.2	ARB Sequencer Mode.....	168
3.7.2.3	File Concept.....	169
3.7.2.4	Impact of the Marker Settings.....	169
3.7.2.5	Impact of the Trigger Settings and Next Segment Settings.....	170
3.7.3	Multi-Segment Settings.....	173
3.7.3.1	Setting for Handling the Multi-Segment Files and Output File Settings.....	174
3.7.3.2	Segment Table.....	176
3.7.3.3	Level / Clock / Marker Settings.....	179
3.7.3.4	Multi-Segment Waveform Sequencing.....	181
	General Settings.....	183
	Sequencing Play List Settings.....	184
3.7.3.5	Next Segment Trigger In Settings.....	186
3.7.4	How to Create and Work with the Multi-Segment Waveform Files.....	189

3.7.5	Reference to Triggering of Multi-Segment Waveforms.....	194
3.7.5.1	Triggering in "Next Trigger Mode = Same Segment".....	195
3.7.5.2	Triggering in "Next Trigger Mode = Next Segment".....	195
3.7.5.3	Triggering in "Next Trigger Mode = Next Segment Seamless".....	196
3.7.5.4	Triggering in "Next Trigger Mode = Sequencer".....	197
3.8	Generating Multi-Carrier Signals.....	197
3.8.1	Required Options.....	198
3.8.2	About the Multi-Carrier Waveforms.....	198
3.8.2.1	Defining the Carrier Frequency.....	199
3.8.2.2	Optimizing the Crest Factor.....	199
3.8.3	Multi-Carrier Settings.....	200
3.8.3.1	General Settings.....	200
3.8.3.2	Carrier Table Settings.....	207
3.8.3.3	Carrier Table Assistant.....	209
3.8.3.4	Carrier Graph.....	211
3.8.4	How to Use the Multi-Carrier Function.....	212
3.9	Generating Multi-Carrier Continuous Wave Signal.....	215
3.9.1	Required Options.....	215
3.9.2	About the MCCW.....	215
3.9.3	MCCW Settings.....	215
3.9.3.1	General Carrier Settings.....	216
3.9.3.2	Carrier Table.....	218
3.9.3.3	Carrier Graph.....	221
3.9.3.4	Trigger, Marker and Clock Setting.....	221
3.9.4	How to Use the Multi-Carrier Continuous Wave Function.....	222
3.9.5	References.....	223
3.10	Shifting and Boosting the Baseband Signal.....	224
3.10.1	About the Baseband Offsets.....	224
3.10.1.1	Impact of the Frequency Offset.....	224
3.10.1.2	Impact of the Phase Offset.....	226
3.10.2	Baseband Offsets Settings.....	226
3.10.3	How to Improve Signal Characteristics by Shifting the Wanted Baseband Signal.....	227
4	Adding Noise and Predistortions, and Impairing the Signal.....	229

4.1	Adding Noise to the Signal.....	229
4.1.1	Required Options.....	229
4.1.2	About the AWGN Generator.....	229
4.1.3	AWGN Settings.....	233
4.1.3.1	General Settings.....	234
4.1.3.2	Noise Power/Output Results Settings.....	236
4.1.4	How to Configure the Noise Generator for Receiver Tests.....	241
4.2	Impairing the Signal.....	243
4.2.1	Required Options.....	243
4.2.2	About the Linear I/Q Impairments.....	243
4.2.2.1	Gain and Gain Imbalance.....	243
4.2.2.2	I and Q Offset.....	244
4.2.2.3	Quadrature Offset.....	245
4.2.3	Analog and Digital Impairments Settings.....	245
4.2.4	How to Optimize the Carrier Leakage and Sidebands Suppression.....	249
4.3	Applying Digital Predistortion.....	250
5	Applying I/Q Vector Modulation.....	251
5.1	Required Options.....	251
5.2	About the I/Q Modulator.....	251
5.3	I/Q Modulator Settings.....	252
5.4	Frequency Response Settings.....	256
5.5	How to Adjust the I/Q Modulator to Optimize Performance.....	258
6	Configuring the RF Signal.....	260
6.1	Required Options.....	261
6.2	How to Access the RF Settings.....	261
6.3	How to Activate the RF Signal Output.....	261
6.4	How to Set the Frequency and Level.....	262
6.5	RF Frequency Settings.....	263
6.6	RF Level Settings.....	266
6.7	RF Phase Settings.....	270
6.8	Reference Oscillator.....	272
6.8.1	Required Options.....	272
6.8.2	Using the Reference Frequency for Instruments Synchronization.....	272

6.8.3	Reference Frequency Settings.....	275
6.8.4	Reference Output Settings.....	277
6.8.5	Adjustment Settings.....	278
6.9	Local Oscillator Coupling.....	279
6.9.1	Required Options.....	280
6.9.2	Phase Coherence.....	280
6.9.3	LO Coupling Settings.....	281
6.9.4	How to Configure Cascaded Instruments.....	282
6.10	Varying the RF Signal in List or Sweep Mode.....	284
6.10.1	Signal Generation and Triggering in the Sweep and List Modes.....	286
6.10.2	About Sweep Mode.....	294
6.10.2.1	Correlating Parameters in Sweep Mode.....	294
6.10.2.2	Sweep Signal Shapes.....	296
6.10.3	About List Mode.....	297
6.10.4	Significant Parameters and Functions.....	298
6.10.5	Sweep Mode Settings.....	300
6.10.5.1	General Sweep Settings.....	300
6.10.5.2	Frequency Range Settings.....	305
6.10.5.3	Level Range Settings.....	307
6.10.6	List Mode Settings.....	308
6.10.6.1	General Settings.....	308
6.10.6.2	List Mode Data Settings.....	311
6.10.6.3	Import/Export Settings.....	312
6.10.7	List Editor.....	314
6.10.8	How to Generate a Signal in List or Sweep Mode.....	317
6.11	Analog Modulations.....	319
6.11.1	Required Options.....	319
6.11.2	Modulation Types and Signal Sources.....	319
6.11.3	Activating Analog Modulations.....	321
6.11.4	Modulation Settings.....	322
6.11.4.1	Pulse Modulation.....	322
6.11.4.2	FM, PhiM and AM Modulation Settings.....	324
6.11.4.3	Pulse Generator.....	329

Pulse Generator > General Settings.....	330
6.11.4.4 Pulse Graph.....	333
6.11.4.5 Pulse External /Trigger Settings.....	334
6.11.4.6 FM, PhiM and AM Modulation Sources.....	335
Source > LF Generator Settings.....	336
Source > External Settings.....	339
Source > Noise Generator Settings.....	340
6.11.4.7 LF Signal Output Settings.....	341
6.11.4.8 Overview.....	343
6.11.5 How to Generate an Amplitude Modulated Signal.....	344
6.11.6 How to Generate a Pulse Modulated Signal.....	345
6.12 Improving Level Performance.....	346
6.12.1 Attenuator.....	346
6.12.1.1 Attenuator Settings.....	347
6.12.1.2 Reverse Power Protection.....	348
6.12.2 ALC - Automatic Level Control.....	349
6.12.2.1 ALC Settings.....	350
6.12.3 User Correction.....	352
6.12.3.1 User Correction Settings.....	355
6.12.3.2 List Editor.....	356
6.12.3.3 Fill with Sensor.....	360
6.12.3.4 Import/Export List Files.....	361
6.12.4 Using Power Sensors.....	363
6.12.4.1 Connecting R&S NRP Power Sensors to the R&S SMBV100B.....	364
6.12.4.2 NRP Sensor Mapping.....	365
6.12.4.3 NRP Power Viewer.....	366
About.....	366
NRP Power Viewer Settings.....	368
6.12.5 How to Calibrate the Power Level with an R&S NRP Power Sensor.....	374
7 Monitoring Signal Characteristics.....	378
7.1 Displaying Baseband Signal Characteristics in Real-Time.....	378
7.1.1 Required Options.....	378
7.1.2 About the Graphical Signal Display.....	378

7.1.2.1	Available Diagrams.....	378
	I/Q Diagram.....	379
	Vector Diagram.....	379
	Constellation Diagram.....	380
	Eye Diagram.....	381
	CCDF Display.....	382
	Power Spectrum.....	383
7.1.2.2	Signal Acquisition Points.....	383
7.1.2.3	Display Functions.....	384
7.1.3	Graphics Configuration Settings.....	385
7.1.4	Graphical Signal Display Settings.....	389
7.1.5	How to Verify the Generated Signal with the Graphics Display.....	391
8	Multi-Instrument Setups.....	398
8.1	Synchronizing Instruments.....	398
8.2	Generating Phase-Coherent Signals.....	398
8.3	Generating Time-Aligned Baseband Signals.....	399
8.3.1	Connecting Multiple Instruments in Master-Slave Mode.....	399
8.3.1.1	Multi-Instrument Settings.....	400
8.3.1.2	How to Connect and Configure Instruments in Master-Slave Mode.....	401
8.3.1.3	Further Information.....	404
8.3.2	Triggering Several Instruments with a Common Trigger Signal.....	405
8.4	Control and Operation of External Instruments.....	406
8.4.1	About Signal Routing and System Configuration.....	406
8.4.1.1	Prerequisites for Control of External Instruments from the R&S SMBV100B.....	407
8.4.1.2	Test Setups.....	407
8.4.1.3	Control of Connected External Instruments.....	407
8.4.1.4	Overview of the Input and Output Signals and Interfaces.....	407
	Overview of the Baseband Signal Sources.....	408
	Overview of the RF Output Signals.....	408
	Important Signal Parameters and Interface's Characteristics.....	409
8.4.1.5	Further Information.....	413
8.5	System Configuration Settings.....	413
8.5.1	I/Q Stream Mapper Settings.....	414

8.5.2	External RF and I/Q Settings.....	414
8.5.2.1	Connections Configuration and Connection Status Overview Settings.....	416
8.5.2.2	External Instrument Configuration Settings.....	420
	Remote Config Settings.....	421
	Remote Control Settings.....	424
	Show Connector.....	425
8.5.3	Overview.....	426
8.6	Digital Baseband Input Settings.....	426
8.6.1	General Settings.....	428
8.6.2	Signal Input Settings.....	430
8.6.3	Sample Rate Settings.....	433
8.6.4	Input Level Settings.....	434
8.7	I/Q Analog Output Settings.....	435
8.7.1	General Analog I/Q Output Settings.....	437
9	File and Data Management.....	442
9.1	About the File System.....	442
9.2	Restoring the (Default) Instrument Configuration.....	445
9.2.1	Preset, Set to Default and Factory Preset Settings.....	447
9.2.2	How to Identify Parameters Which Are Not in a Preset State.....	448
9.2.3	How to Recall User Settings Automatically after Preset.....	449
9.2.4	Reference.....	449
9.3	Protecting Data.....	451
9.4	Saving and Recalling Instrument Settings.....	451
9.4.1	Save/Recall Settings.....	452
9.4.2	How to Save and Recall Instrument Settings.....	456
9.4.3	How to Recall the Settings of a Firmware Option.....	457
9.5	Accessing Files with User Data.....	457
9.5.1	File Select Settings.....	458
9.5.2	How to Create and Access Data and Control Lists.....	461
9.6	Exporting Remote Command Lists.....	461
9.7	Loading, Importing and Exporting Lists.....	461
9.8	Using the File Manager.....	462
9.8.1	File Manager Settings.....	463

9.8.2	Map Network Share Settings.....	464
9.8.3	How to Display All Saved Files.....	466
9.8.4	How to Map a Network Folder.....	466
9.9	How to Transfer Files from and to the Instrument.....	468
9.9.1	Removing File System Protection.....	469
9.9.2	Accessing the File System of the R&S SMBV100B Via ftp.....	470
9.9.3	Accessing the R&S SMBV100B File System Via SMB (Samba).....	471
9.9.4	Using a USB Storage Device for File Transfer.....	473
9.9.5	Using a File Server for Test Files Exchange.....	473
9.10	Creating Screenshots of Current Settings.....	474
9.10.1	Hardcopy Settings.....	474
9.10.2	How to Save a Hardcopy of the Display.....	478
10	General Instrument Functions.....	480
10.1	Customizing the User Interface.....	480
10.1.1	Display and Keyboard Settings.....	481
10.1.2	Appearance Settings.....	483
10.1.3	Display Update Settings.....	483
10.1.4	Defining the RF Signal State On Power On	484
10.1.5	How to Set the Initial Instrument Settings.....	485
10.1.5.1	Setting the Keyboard Language.....	485
10.1.5.2	Setting the Screen Saver.....	485
10.1.5.3	Adjusting Appearance of the User Interface	486
10.2	Configuring the Global Connectors.....	486
10.2.1	Required Options.....	486
10.2.2	About the Global Connectors.....	486
10.2.2.1	Global Connectors.....	487
10.2.2.2	Trigger, Marker, Clock and RF Connectors.....	487
10.2.2.3	Status Indicators.....	488
10.2.3	Trigger Marker Clock Settings.....	488
10.2.3.1	Overview Table.....	489
10.2.3.2	Global Connector Settings.....	490
10.2.4	RF Connectors Settings.....	490
10.2.5	Global Connectors Settings.....	491

10.2.6	How to Enable Signals and Perform Signal to Connector Mapping.....	495
10.3	Organizing Frequently Used Settings as Favorites.....	496
10.3.1	Using the User Menu for Fast Adjustments.....	497
10.3.2	Define User Key Actions Settings.....	499
10.3.3	Assigning Actions to the [★ (User)] Key.....	500
10.4	Managing Licenses and License Keys.....	501
10.4.1	Manage License Keys Settings.....	502
10.4.2	How to Move a Portable License.....	504
10.5	Using the Security Settings.....	505
10.5.1	Protection Level Settings.....	506
10.5.2	Setting Security Parameters.....	507
10.5.2.1	Update Policy Security Settings.....	508
10.5.2.2	Disk & Memory Security Settings.....	509
10.5.2.3	Manual Operation Security Settings.....	510
10.5.3	Configuring LAN Services.....	513
10.5.4	Password Management.....	515
10.6	Undoing or Restoring Actions.....	517
10.7	Shutting Down and Rebooting the Instrument.....	519
11	Network Operation and Remote Control.....	520
11.1	Overview of Remote Access Modes.....	520
11.2	Remote Control Interfaces and Protocols.....	522
11.2.1	LAN Interface.....	523
11.2.1.1	VISA Resource Strings.....	523
11.2.1.2	HiSLIP Protocol.....	525
11.2.1.3	VXI-11 Protocol.....	525
11.2.1.4	Socket Communication.....	525
11.2.2	USB Interface.....	526
11.2.2.1	USB Resource String.....	526
11.2.3	GPIB Interface (IEC/IEEE Bus Interface).....	527
11.2.4	LXI Browser Interface.....	527
11.3	Remote Control Programs and Libraries.....	528
11.3.1	VISA Library.....	528
11.3.2	Possible Setups and Access Functions.....	529

11.4 Remote Access Settings.....	531
11.4.1 Network Settings.....	532
11.4.2 Visa Resource Strings.....	535
11.4.3 GPIB Address Settings.....	536
11.4.4 RS232 Settings.....	536
11.4.5 Instrument Emulations Settings.....	537
11.4.6 Active Connections Settings.....	538
11.4.7 QR Code.....	539
11.5 LXI Settings.....	540
11.5.1 LXI Status Settings.....	541
11.5.2 LXI Browser Settings.....	542
11.5.2.1 LAN Configuration.....	543
IP Configuration.....	543
Advanced Config.....	544
Ping Client.....	545
SCPI Remote Trace.....	545
Data Sheet.....	546
11.6 How to Find the VISA Resource String.....	547
11.7 How to Change the GPIB Instrument Address.....	548
11.8 How to Set Up a Remote Control Connection.....	548
11.8.1 Establishing a Remote Control Connection over the LXI Browser Interface.....	549
11.8.2 Establishing a Remote Control Connection over LAN Using VXI-11 Protocol.....	550
11.8.3 Setting Up a Remote Control Connection over LAN Using Socket Communication..	555
11.8.4 Setting Up a Remote Control Connection over GPIB.....	556
11.8.5 Setting Up a Remote Control Connection over USB.....	557
11.9 Tracing SCPI Commands and Messages Exchanged via the LXI Web Browser Interface.....	557
11.10 How to Return to Manual Operation.....	558
11.11 Automating Tasks with Remote Command Scripts.....	559
11.11.1 Show SCPI Command.....	561
11.11.2 Displaying an SCPI List.....	562
11.11.3 SCPI Recording Export Settings.....	563
11.12 How to Find Out the SCPI Command Corresponding to the Manual Operation via Show SCPI Command.....	564

11.13	How to Find Out the SCPI Command Corresponding to the Manual Operation Using the Online Help.....	564
11.14	How to Record / Create SCPI Lists.....	565
11.15	How to Convert and Save SCPI Lists.....	568
11.16	How to Set Up Remote Operation via VNC.....	569
11.16.1	Setting Up a Remote Operation from a Desktop System.....	569
11.16.1.1	Using a Web Browser.....	569
11.16.1.2	Using a VNC Client Software.....	570
11.16.2	Setting Up a Remote Operation from a Smart Device.....	572
11.16.2.1	Using a VNC App.....	573
11.16.2.2	Using a Web Browser with HTML5.....	573
11.16.2.3	Special Mode QR Code	574
11.17	References.....	575
11.17.1	LXI Functionality.....	575
11.17.2	Code Generator Templates.....	575
11.17.3	Remote Control States	577
12	Remote Control Commands.....	579
12.1	Conventions used in SCPI Command Descriptions.....	579
12.2	Backward Compatibility with Other Rohde & Schwarz Signal Generators.....	580
12.3	Programming Examples.....	580
12.4	Common Commands.....	581
12.5	Preset Commands.....	585
12.6	MMEMory Subsystem.....	587
12.6.1	File Naming Conventions.....	587
12.6.2	Accessing Files in the Default or in a Specified Directory.....	588
12.6.3	Programming Examples.....	590
12.6.4	Remote Control Commands.....	592
12.7	CALibration Subsystem.....	599
12.8	DIAGnostic Subsystem.....	603
12.9	DISPlay Subsystem.....	605
12.10	FORMat Subsystem.....	610
12.11	HCOPy Subsystem.....	611
12.11.1	Hard Copy Settings.....	612

12.11.2	Automatic Naming.....	614
12.12	KBOard Subsystem.....	616
12.13	OUTPut Subsystem.....	617
12.14	SENSe, READ, INITiate and SLISt Subsystems.....	620
12.15	SCONfiguration Subsystem.....	633
12.15.1	Multi Instrument Configuration.....	635
12.15.2	I/Q Stream Mapping.....	636
12.15.3	External RF and I/Q Instruments.....	636
12.16	SOURce Subsystem.....	647
12.16.1	Connector Settings.....	648
12.16.2	SOURce:BBIN Subsystem.....	652
12.16.3	Analog Modulation Subsystems.....	659
12.16.3.1	SOURce:MODulation Subsystem.....	660
12.16.3.2	SOURce:AM Subsystem.....	660
12.16.3.3	SOURce:FM Subsystem.....	665
12.16.3.4	SOURce:PM Subsystem.....	670
12.16.3.5	SOURce:PULM Subsystem.....	674
	Pulse Modulation Settings.....	674
12.16.4	SOURce:BB Subsystem.....	680
12.16.4.1	SOURce:BB Subsystem General Commands.....	680
12.16.4.2	SOURce:BB:DM Subsystem.....	683
	Programming Examples.....	683
	General Commands.....	685
	Save/Recall Settings.....	687
	Filter Settings.....	689
	Modulation and Coding Settings.....	690
	Power Ramping.....	694
	Trigger Settings.....	696
	Marker Settings.....	699
	Clock Settings.....	701
	Handling List Files.....	701
12.16.4.3	SOURce:BB:ARbitrary Subsystem.....	707
	Programming Examples.....	708

General Commands.....	716
Test Signal Commands.....	717
Waveform Commands.....	720
Multi-Segment Commands.....	724
Multi-Segment Sequencing Commands.....	729
Multi-Carrier Commands.....	732
Trigger Commands.....	744
Marker Commands.....	747
Clock Commands.....	749
12.16.4.4 Waveform, Data and List Format.....	750
Tag Description.....	750
How to Define Periodically Repeating Traces.....	762
How to Manually Create a Waveform Using Tag File Format.....	763
How to Create a Control List Using Tag File Format.....	767
How to Create a Data List Using Tag File Format.....	769
Editing Waveform Files, Data and Control Lists.....	770
12.16.4.5 SOURce:BB:MCCW Subsystem.....	771
Programming Examples.....	771
General Settings and Carrier Setup Settings.....	775
Trigger Settings.....	782
Marker Settings.....	785
Clock Settings.....	787
12.16.4.6 SOURce:AWGN Subsystem.....	787
12.16.4.7 SOURce:BB:IMPairment Subsystem.....	794
12.16.4.8 SOURce:BB:GRAPhics Subsystem.....	799
12.16.4.9 SOURce:BB:PROGress Subsystem General Commands.....	802
12.16.5 SOURce:CORRection Subsystem.....	802
12.16.5.1 Correction Settings.....	805
12.16.5.2 Correction Data Exchange.....	808
12.16.5.3 Frequency Response Commands.....	810
12.16.6 SOURce:FREQuency Subsystem.....	812
12.16.7 SOURce:INPut Subsystem.....	821
12.16.8 SOURce:IQ Subsystem.....	822

12.16.9	SOURce:IQ:OUTPut Subsystem.....	824
12.16.9.1	SOURce:IQ:OUTPut:ANALog Commands.....	825
12.16.10	SOURce:LFOutput Subsystem.....	829
12.16.10.1	LF Generator Settings.....	831
12.16.10.2	LF Sweep Settings.....	839
12.16.11	SOURce:LIST Subsystem.....	842
12.16.11.1	List Mode Settings.....	845
12.16.11.2	List Mode File Operation.....	851
12.16.11.3	List Mode Data Exchange.....	853
12.16.12	SOURce:NOISe Subsystem.....	855
12.16.13	SOURce:PGEN Subsystem.....	857
12.16.14	SOURce:PHASe Subsystem.....	858
12.16.15	SOURce:POWer Subsystem.....	859
12.16.16	SOURce:ROSCillator Subsystem.....	869
12.16.17	SOURce:SWEep Subsystem.....	874
12.17	SYSTem Subsystem.....	882
12.18	STATus Subsystem.....	906
12.19	TEST Subsystem.....	910
12.20	TRIGger Subsystem.....	915
12.21	UNIT Subsystem.....	917
13	Maintenance.....	919
13.1	Cleaning.....	919
13.2	Storing and Packing.....	920
13.3	Performing Maintenance Tasks.....	921
13.3.1	Date and Time Settings.....	922
13.3.2	Check Front Panel.....	924
13.3.2.1	Check Front Panel Settings.....	924
13.3.2.2	How to Test the Front Panel.....	925
13.3.3	Internal Adjustment Settings.....	927
13.3.4	Selftest Connections Settings.....	928
13.3.5	Selftest Baseband Settings.....	930
13.3.6	Selftest Test Generator Settings (DAC).....	930
13.3.7	FPGA/uC Update Settings.....	932

13.3.8	Delete Temporary Files.....	933
13.3.9	Requesting Instrument Configuration and Specifications.....	934
13.3.9.1	Hardware Configuration Settings.....	934
13.3.9.2	Versions/Options Settings.....	935
13.3.9.3	Requesting the Data Sheet.....	937
14	Troubleshooting and Error Messages.....	938
14.1	Error Messages.....	938
14.1.1	Volatile Messages.....	938
14.1.2	Permanent Messages.....	938
14.2	SCPI-Error Messages.....	939
14.3	Device-Specific Error Messages.....	939
14.4	Querying Error Messages & Info Key.....	941
14.5	Resolving Network Connection Failures.....	943
14.6	Collecting Information for Technical Support.....	944
	Annex.....	946
A	Reference Information for Remote Control.....	946
A.1	Additional Basics on Remote Control.....	946
A.1.1	Messages.....	946
A.1.2	LAN Interface Messages.....	947
A.1.3	SCPI Command Structure.....	947
A.1.3.1	Syntax for Common Commands.....	948
A.1.3.2	Syntax for Device-Specific Commands.....	948
	Long and short form.....	949
	Numeric Suffixes.....	949
	Optional Mnemonics.....	949
A.1.3.3	SCPI Parameters.....	950
	Numeric Values.....	950
	Special Numeric Values.....	951
	Boolean Parameters.....	951
	Text Parameters.....	952
	Character Strings.....	952
	Block Data.....	952

A.1.3.4	Overview of Syntax Elements.....	952
A.1.3.5	Structure of a Command Line.....	954
A.1.3.6	Responses to Queries.....	954
A.1.4	Command Sequence and Synchronization.....	955
A.1.4.1	Preventing Overlapping Execution.....	955
A.1.4.2	Examples to Command Sequence and Synchronization.....	957
A.1.5	Status Reporting System.....	958
A.1.5.1	Hierarchy of the Status Registers.....	959
A.1.5.2	Structure of a SCPI Status Register.....	960
A.1.5.3	Status Byte (STB) and Service Request Enable Register (SRE).....	962
A.1.5.4	Event Status Register (ESR) and Event Status Enable Register (ESE).....	963
A.1.5.5	Questionable Status Register (STATus:QUESTionable).....	964
A.1.5.6	Operation Status Register (STATus:OPERation).....	964
A.1.5.7	Application of the Status Reporting System.....	964
	Service Request.....	965
	Serial Poll.....	965
	Query of an instrument status.....	965
	Error Queue.....	966
A.1.5.8	Reset Values of the Status Reporting System.....	966
A.1.6	General Programming Recommendations.....	967
A.2	Telnet program examples.....	967
A.3	Extensions for User Files.....	972
B	Hardware Interfaces.....	975
B.1	GPIB-Bus Interface.....	975
	Glossary: List of the Often Used Terms and Abbreviations.....	977
	List of Commands.....	982
	Index.....	1000

1 Preface

The R&S SMBV100B is a new signal generator developed to meet demanding customer requirements. Offering excellent signal characteristic and straightforward and intuitive operation, the signal generator makes signal generation fast and easy.

1.1 Key Features

Outstanding key features of the R&S SMBV100B are:

- Frequency range from 8 kHz to 6 GHz
- Up to 500 MHz I/Q modulation bandwidth (in RF) with internal baseband
- Support of all important digital standards such as LTE incl eMTC/NB-IoT, 3GPP FDD/HSPA/HSPA+, GSM/EDGE/EDGE evolution, OFDM, 5G NR, WLAN IEEE 802.11a/b/g/n/j/p/ac/ax
- Excellent signal quality for high accuracy in spectral and modulation measurements
- Intuitive operation via touchscreen with block diagram as key element
- Graphical signal monitoring at practically every point in the signal flow
- SCPI macro recorder and code generator for generating executable remote control code from manual operating steps (for MATLAB®, CVI, etc.)

For a detailed specification, refer to the data sheet.

1.2 For Your Safety

The R&S SMBV100B is designated for the development, production and verification of electronic components and devices in industrial and laboratory environments. Use the R&S SMBV100B only for its designated purpose. Observe the operating conditions and performance limits stated in the data sheet.

The product documentation helps you to use the R&S SMBV100B safely and efficiently. Keep the product documentation in a safe place and pass it on to the subsequent users.

Safety information is part of the product documentation. It warns you about the potential dangers and gives instructions how to prevent personal injury or damage caused by dangerous situations. Safety information is provided as follows:

- In the "Basic Safety Instructions", safety issues are grouped according to subjects. For example, one subject is electrical safety. The "Basic Safety Instructions" are delivered with the R&S SMBV100B in different languages in print.
- Throughout the documentation, safety instructions are provided when you need to take care during setup or operation. Always read the safety instructions carefully.

Make sure to comply fully with them. Do not take risks and do not underestimate the potential danger of small details such as a damaged power cable.

1.3 About This Manual

This User Manual describes general instrument functions, the operation of the instrument and settings common to all firmware options. The settings specific to the firmware options are described in the corresponding user manuals.

The main focus of this manual is on the signal generation capabilities of the instrument and the tasks required to achieve them. The following topics are included:

- **Getting Started**
Information that you have received as a printed book together with your instrument
- **Configuring the Internal Baseband Source**
Descriptions of the individual generation modes, including configuration settings and task descriptions
- **Adding Noise and Predistortions, and Impairing the Signal**
Descriptions of the noise generation, signal impairment and digital predistortion, including configuration settings and task descriptions
- **Applying I/Q Vector Modulation**
Descriptions of the configuration settings
- **Configuring the RF Signal**
Descriptions of the individual operation modes, including configuration settings and task descriptions
- **Monitoring Signal Characteristics**
The concept of real-time graphic display and the baseband power level surveillance function
- **File and Data Management**
Description of general functions to handle data files and work with the file system of the instrument
- **General Instrument Functions**
Description of the general instrument settings and functions
- **Network Operation and Remote Control**
Information on setting up the instrument in a network and controlling it remotely.
- **Remote Control Commands**
Remote commands required to configure and perform measurements in a remote environment, sorted by tasks
Remote commands required to set up the environment and to perform common tasks on the instrument, sorted by tasks
Programming examples demonstrate the use of many commands and can usually be executed directly for test purposes
- **Maintenance**
Information on tasks required to maintain the operability of the instrument
- **Troubleshooting and Error Messages**
Hints and tips on how to handle errors

- **Appendix**
Extensive reference information on remote control, hardware interfaces, etc.
- **Glossary**
List of often used terms and abbreviations
- **List of Commands and Waveform Tags**
Alphabetical list of all remote commands and waveform tags described in the manual
- **Index**

Contents and scope

This description assumes R&S SMBV100B equipped with all available options. Depending on your model and the installed options, some of the functions may not be available on your instrument.

Notes on screenshots

When describing the functions of the product, we use sample screenshots. These screenshots are meant to illustrate as much as possible of the provided functions and possible interdependencies between parameters. The shown values may not represent realistic usage scenarios.

The screenshots usually show a fully equipped product, that is: with all options installed. Thus, some functions shown in the screenshots may not be available in your particular product configuration.

1.4 Documentation Overview

This section provides an overview of the R&S SMBV100B user documentation. Unless specified otherwise, you find the documents on the R&S SMBV100B product page at:

www.rohde-schwarz.com/manual/smbv100b

1.4.1 Getting Started Manual

Introduces the R&S SMBV100B and describes how to set up and start working with the product. Includes basic operations, typical measurement examples, and general information, e.g. safety instructions, etc. A printed version is delivered with the instrument.

1.4.2 User Manuals and Help

Separate manuals for the base unit and the software options are provided for download:

- **Base unit manual**
Contains the description of all instrument modes and functions. It also provides an introduction to remote control, a complete description of the remote control com-

mands with programming examples, and information on maintenance, instrument interfaces and error messages. Includes the contents of the getting started manual.

- **Software option manual**
Contains the description of the specific functions of an option. Basic information on operating the R&S SMBV100B is not included.

All user manuals are also available for download or for immediate display on the Internet.

1.4.3 Service Manual

Describes the performance test for checking the rated specifications, module replacement and repair, firmware update, troubleshooting and fault elimination, and contains mechanical drawings and spare part lists.

The service manual is available for registered users on the global Rohde & Schwarz information system (GLORIS, <https://gloris.rohde-schwarz.com>).

1.4.4 Instrument Security Procedures

Deals with security issues when working with the R&S SMBV100B in secure areas. It is available for download on the Internet.

1.4.5 Basic Safety Instructions

Contains safety instructions, operating conditions and further important information. The printed document is delivered with the instrument.

1.4.6 Data Sheets and Brochures

The data sheet contains the technical specifications of the R&S SMBV100B. It also lists the options and their order numbers and optional accessories.

The brochure provides an overview of the instrument and deals with the specific characteristics.

See www.rohde-schwarz.com/brochure-datasheet/smbv100b

1.4.7 Release Notes and Open Source Acknowledgment (OSA)

The release notes list new features, improvements and known issues of the current firmware version, and describe the firmware installation.

The open source acknowledgment document provides verbatim license texts of the used open source software.

See www.rohde-schwarz.com/firmware/smbv100b

1.4.8 Application Notes, Application Cards, White Papers, etc.

These documents deal with special applications or background information on particular topics.

See www.rohde-schwarz.com/application/smbv100b

2 Getting Started

2.1 Preparing for Use

- [Putting into Operation](#)..... 28
- [Linux Operating System](#)..... 35
- [Connecting USB Devices](#)..... 36
- [Setting Up a Network \(LAN\) Connection](#)..... 37

2.1.1 Putting into Operation

This section describes the basic steps to be taken when setting up the R&S SMBV100B for the first time.

WARNING

Risk of injury due to disregarding safety information

Observe the information on appropriate operating conditions provided in the data sheet to prevent personal injury or damage to the instrument. Read and observe the basic safety instructions provided with the instrument, in addition to the safety instructions in the following sections. In particular:

- Do not open the instrument casing.

NOTICE

Risk of instrument damage due to inappropriate operating conditions

Specific operating conditions are required to ensure accurate measurements and to avoid damage to the instrument. Observe the information on appropriate operating conditions provided in the basic safety instructions and the instrument's data sheet.

NOTICE

Instrument damage caused by electrostatic discharge

Electrostatic discharge (ESD) can damage the electronic components of the instrument and the device under test (DUT). Electrostatic discharge is most likely to occur when you connect or disconnect a DUT or test fixture to the instrument's test ports. To prevent electrostatic discharge, use a wrist strap and cord and connect yourself to the ground, or use a conductive floor mat and heel strap combination.

NOTICE**Risk of instrument damage due to inappropriate operating conditions**

An unsuitable operating site or test setup can damage the instrument and connected devices. Before switching on the instrument, observe the information on appropriate operating conditions provided in the data sheet. In particular, ensure the following:

- All fan openings are unobstructed and the airflow perforations are unimpeded. The minimum distance from the wall is 10 cm.
- The instrument is dry and shows no sign of condensation.
- The instrument is positioned as described in the following sections.
- The ambient temperature does not exceed the range specified in the data sheet.
- Signal levels at the input connectors are all within the specified ranges.
- Signal outputs are connected correctly and are not overloaded.

2.1.1.1 EMI Suppression

Electromagnetic interference (EMI) may affect the measurement results.

To suppress generated Electromagnetic Interference (EMI),

- Use suitable shielded cables of high quality. For example use double-shielded RF, BNC and LAN cables (CAT6 STP).
Note: USB cables are of varying and often poor quality. Therefore, check the quality of each individual USB cable as described in the service manual.
- Always terminate open cable ends.
- For connection to the HS Dig I/Q interfaces of the instrument, use:
 - QSFP+ passive copper cable with max. length of 3 m
 - Active optical cable with max. power class 2 module (2.0 W max. power consumption)



Front USB-Connectors are intended for service and file transfer purposes only. Connect USB memory devices directly to the front USB connectors to transfer files to or from the instrument. These connectors are fully functional but EMC classification is not guaranteed if these front USB connectors are used.

Note the EMC classification in the data sheet.

2.1.1.2 Unpacking and Checking the Instrument

Unpack the R&S SMBV100B carefully and check the contents of the package.

- Check if all items listed on the delivery note, including this getting started manual, are included in the delivery.
- Check the R&S SMBV100B for any damage.
If the contents are damaged, immediately contact the carrier who delivered the package.

**Packing material**

Retain the original packing material. If the instrument needs to be transported or shipped later, you can use the material to protect the control elements and connectors.

**WARNING****Risk of injury during transportation**

The carrying handles at the front and side of the casing are designed to lift or carry the instrument. Do not apply excessive force to the handles. If a handle is ripped off, the falling instrument can cause injury.

Be aware of the weight of the instrument when lifting it. Observe the information on transporting heavy instruments in the basic safety instructions provided with the instrument.

2.1.1.3 Accessory List

The instrument comes with the following accessories:

- Power cable
- Getting Started printed manual

2.1.1.4 Placing or Mounting the Instrument

The R&S SMBV100B is designed for use under laboratory conditions, either on a bench top or in a rack using the standard rackmount kit.

Bench top operation

If the R&S SMBV100B is operated on a bench top, the surface must be flat. The instrument can be used in horizontal position, standing on its feet, or with the support feet on the bottom extended.

⚠ WARNING**Risk of injury if feet are folded out**

The feet can fold in if they are not folded out completely or if the instrument is shifted. Collapsing feet can cause injury or damage the instrument.

- Fold the feet completely in or out to ensure stability of the instrument. Never shift the instrument when the feet are folded out.
- When the feet are folded out, do not work under the instrument or place anything underneath.
- The feet can break if they are overloaded. The overall load on the folded-out feet must not exceed 500 N.

**⚠ WARNING****Risk of injury when stacking instruments**

A stack of instruments can tilt over and cause injury if not stacked correctly. Furthermore, the instruments at the bottom of the stack can be damaged due to the load imposed by the instruments on top.

Observe the following instructions when stacking instruments:

- Never stack more than three instruments. If you need to stack more than three instruments, install them in a rack.
- The overall load imposed on the lowest instrument must not exceed 500 N.
- It is best if all instruments have the same dimensions (width and length). If you need to stack smaller instruments on the top, the overall load imposed on the lowest instrument must not exceed 250 N.
- If the instruments have foldable feet, fold them in completely.

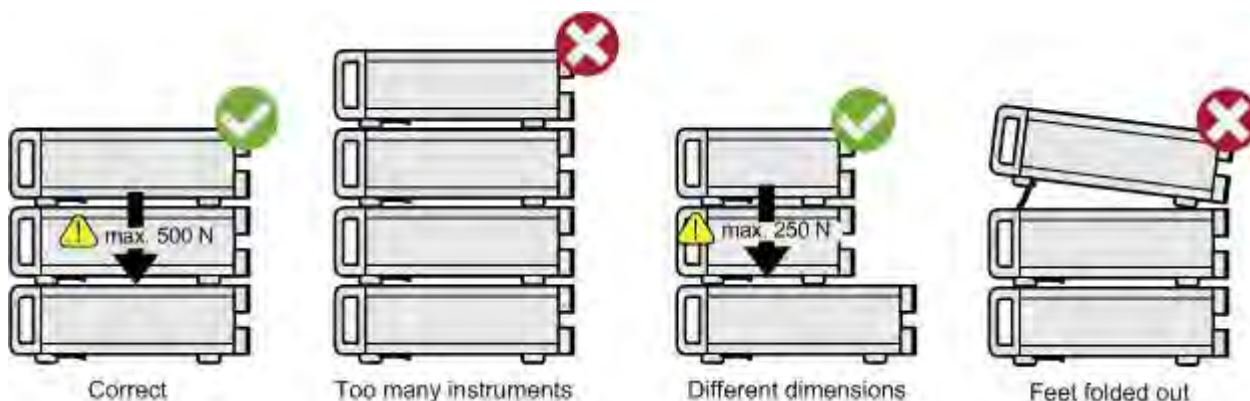

Mounting in a rack

The R&S SMBV100B can be installed in a rack using a rack adapter kit (Order No. see data sheet). The installation instructions are part of the adapter kit.

NOTICE

Risk of instrument damage due to insufficient airflow in a rack

If the instrument is run with insufficient airflow for a longer period, the instrument overheats, which can disturb the operation and even cause damage.

Make sure that all fan openings are unobstructed, that the airflow perforations are unimpeded, and that the minimum distance from the wall is 10 cm.

2.1.1.5 Connecting AC Power

The R&S SMBV100B is equipped with an AC power supply connector, that can be operated with different AC power voltages. Once it is connected, the instrument automatically adjusts to the given voltage. Refer to the data sheet for the requirements of voltage and frequency. There is no need to set the voltage manually or change fuses.

The [AC supply and power switch](#) is at the rear of the unit.

To connect the AC supply

- ▶ Connect the R&S SMBV100B to the AC power source using the supplied power cable.

Note: Since the instrument is designed in compliance with standard EN 61010-1 safety class I, it must only be connected to an outlet that has a ground contact.

Characteristics of the AC power supply:

- 100 V to 240 V AC
- Max 3.5 A to 1.6 A (50 Hz to 60 Hz)
- Max 3.5 A to 2.9 A (400 Hz)

2.1.1.6 Turning the Instrument On and Off

To turn on the R&S SMBV100B

1. [Connect the instrument to the AC supply](#).
2. Turn on the main AC power switch at the rear panel of the R&S SMBV100B (position "I" (on)).

The instrument is supplied with AC power.



Warm-up time for OCXO

When the instrument is switched on, the OCXO requires an extended warm-up time (see data sheet).

To start the R&S SMBV100B

Starting the R&S SMBV100B requires that it is **connected** and **turned on**.

- ▶ At the front panel, press the [On/Standby] key briefly.

The instrument boots the operating system and starts the instrument firmware.

After booting, the instrument is in the state before the last power off (standby or ready), indicated by the color of the [On/Standby] key's LEDs:

- Green: the R&S SMBV100B is running and ready for operation.
All modules are power-supplied.
- Orange: the R&S SMBV100B is in standby mode (main AC power switch is in position "I").

The standby power mode keeps the power switch circuits and the oven-controlled crystal oscillator OCXO active. In this state, it is safe to switch off the AC power and disconnect the instrument from the power supply.

To switch between standby and ready state, briefly press the [On/Standby] key.

If a previous session was terminated regularly, the instrument uses the last setup with the relevant instrument settings.

- ▶ To set up a new configuration, press the [Preset] key to return the instrument to its defined reset/preset state.



To customize the start settings, e.g. to recall previously saved settings:

- Use the [Save/Rcl] function or
- Define the [★ (User)] key.

To shut down and turn off the R&S SMBV100B

NOTICE

Risk of losing data

If you switch off the running instrument using the rear panel switch or by disconnecting the power cord, the instrument loses its current settings. Furthermore, program data can be lost.

Press the On/Standby key first to shut down the application properly.

1. Press the [On/Standby] key.

The current setup is saved, the operating system shuts down and sets the instrument to standby state.

The [On/Standby] LED must be orange.

2. Turn off the main AC power switch at the rear panel of the R&S SMBV100B (position "0" (off)).

The instrument is no longer supplied with AC power.



Turning off the AC power

You can leave the AC power on permanently. Switching off is required only if the instrument must be disconnected from all power supplies.

2.1.1.7 Functional Check

When the instrument is switched on, it automatically monitors the main functions.

A detected fault is indicated by an "Error" message displayed in the "Info" line of the instrument together with a brief error description. For an in-depth identification of the error, tap on the "Info" indication. In response, a description of the errors is displayed. For more information, refer to the "Troubleshooting and Error Messages" section in the user manual.

In addition to the automatic monitoring, the R&S SMBV100B offers the following capabilities to assure correct functioning:

- Internal adjustments
Select the "System Config > Setup > General > Internal Adjustments" to access the dialog for performing and configuring the adjustments settings.
- Self-test
A self-test is provided for service purposes ("System Config > Setup > Maintenance > Selftest").
- Test points
If necessary for service purposes, internal test points can be queried. These tests are protected test procedures, which can be accessed if protection level 2 is disabled. The corresponding procedure is described in the Service Manual.

2.1.1.8 Default Settings

When the instrument is switched on, it is not the preset state that is active, but the state that was set before the instrument was switched off. Use the [Preset] function to return the instrument to its defined preset state every time a new configuration is required or the current setup is no longer relevant.

The R&S SMBV100B offers a four-stage preset concept:

- Preset of one individual parameter
The selective preset on a parameter basis is triggered over the "Preset this parameter" function in the context menu
- Preset of the settings belonging to a digital standard or associated with one dialog
Most of the dialog boxes provide a special "Set to Default" function that resets the settings associated to the corresponding dialog. This function is available for all digital modulation settings and the ARB generator.
These settings are identical to the settings called up using the [Preset] key.

- Preset of the instrument to a predefined state
The [Preset] key calls up a defined instrument setup. All parameters and switching states are preset (also the states of inactive operating modes). The default instrument settings provide a reproducible initial basis for all other settings. However, functions that concern the integration of the instrument into a measurement setup are not changed, for example reference oscillator source settings.
- Preset of the instrument to its factory settings
The instrument can also be forced to load its default factory settings, except that the security settings are not affected. To access the corresponding dialog box, select the "Taskbar > System Config > Setup > Settings > Factory Preset" function.



For more information and an overview of the settings affected by the factory preset function, see [Chapter 9.2, "Restoring the \(Default\) Instrument Configuration"](#), on page 445.



User-defined instrument states can be stored and called up using the "Setup > Save/Recall" function or the [Save/Rcl] key.

2.1.1.9 Checking the Supplied Options and Licenses

The instrument can be equipped with both, hardware and firmware options. To check whether the installed options correspond to the options indicated on the delivery note, proceed as follows:

1. Press the [Setup] key.
2. Select "Instrument Assembly > Hardware Config" and "Software / Options".
A list with hardware and firmware information is displayed.
3. Check the availability of the hardware options as indicated in the delivery note.
For an overview of the available options, refer to the data sheet.

See also [Chapter 13.3.9, "Requesting Instrument Configuration and Specifications"](#), on page 934.

2.1.2 Linux Operating System

The instrument uses an embedded Linux operating system, optimally adapted to the signal generator.



Accessing the operating system

No access to the operating system is required for normal operation.
All necessary system settings can be made in the "Setup" dialog.

The R&S SMBV100B provides an internal memory that holds the operating system, the firmware, and the stored data. The folder `/var/user` and all subfolders can be used to store user data.

Accessing the file system

Data transfer is possible via a memory stick connected to a USB interface. The memory stick and the internal memory are accessed via the [Save/Rcl] > "File Manager" function.

The instrument also supports two standard methods to access the file system from a remote client:

- FTP (file transfer protocol)
- File sharing according to the SAMBA/SMB (server message block) protocol.

Both methods allow you the access to the folder `/user`.



Default password

The FTP and SAMBA file access use the user "instrument" with default password "instrument".

We recommend that you change this password in the "Setup > Security > Password Management > Change User Password" dialog before connecting the instrument to the network.

See [Chapter 10.5.4, "Password Management"](#), on page 515.

2.1.3 Connecting USB Devices

The USB interfaces of the R&S SMBV100B allow you to connect USB devices, including USB hubs directly to the instrument. Due to the large number of available USB devices, there is almost no limit to the expansions that are possible with the R&S SMBV100B.

The following list shows various USB devices that can be useful:

- Memory stick for easy transfer of data to/from a computer (for example firmware updates)
- Keyboard or mouse to simplify the entry of data, comments, filenames, etc.
- Power sensors of the R&S NRP families

All USB devices can be connected to or disconnected from the instrument during operation.

Connecting a USB storage device

When a USB storage device like a memory stick, a CD-ROM drive, or a hard disk is connected, it is detected automatically. The device is made available as a new drive (`/usb`). The name of the drive is manufacturer-dependent.

Connecting a keyboard

A keyboard is detected automatically when it is connected. The default keyboard layout is English – US.

Use the "Setup > User Interface > USB Keyboard Settings" dialog to configure the keyboard properties (see [Chapter 10.1.5.1, "Setting the Keyboard Language"](#), on page 485).

Connecting a mouse

A mouse is detected automatically when it is connected.

2.1.4 Setting Up a Network (LAN) Connection

The R&S SMBV100B is equipped with a network interface and can be connected to an Ethernet LAN (local area network). Provided the appropriate rights have been assigned by the network administrator, the interface can be used, for example:

- To transfer data between a controller and the instrument, for example to run a remote control program.
See [Chapter 11, "Network Operation and Remote Control"](#), on page 520.
- To access or operate the instrument from a remote computer using the Ultr@VNC program (or a similar tool, like another VNC client or any Web browser supporting Java).
- To transfer data from a remote computer and back, for example using network folders.
- To use power sensors with network capability, e.g. the R&S NRP LAN power sensors.

This section describes how to configure the LAN interface.



Accessing operating system

No access to the operating system is required for normal operation.
All necessary system settings can be made in the "Setup" dialog.

2.1.4.1 Connecting the Instrument to the Network

There are two methods to establish a LAN connection to the instrument:

- A non-dedicated network (Ethernet) connection from the instrument to an existing network
- A dedicated network connection (Point-to-point connection) between the instrument and a single computer

For addressing, both the instrument and the computer require an IP address. The address information is usually assigned to the devices automatically, depending on the network capabilities.

If the IP address is not assigned automatically, see [Chapter 2.1.4.3, "Assigning the IP Address"](#), on page 39 for information on how to assign the address manually.

To set up a network (LAN) connection

NOTICE

Risk of network failure

Consult your network administrator before performing the following tasks:

- Connecting the instrument to the network
- Configuring the network
- Changing IP addresses

Errors can affect the entire network.

- ▶ Connect the instrument to the network or to a single PC.

If the instrument is connected to the LAN, the operating system automatically detects the network connection and activates the required drivers.

By default, the instrument is configured to use DHCP (dynamic host configuration protocol) configuration and to obtain the whole address information automatically.

When connected, the R&S SMBV100B displays the address information on the screen.

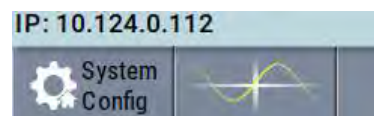

Risk of network connection failure

Network cables and cable connectors of poor quality, or failures in the autonegotiation process, can cause network connection failures.

If the network connection to the instrument fails, check the network infrastructure and contact your network administrator.

For details, see section "Troubleshooting and Error Messages".

2.1.4.2 Using Computer Names (Hostnames)

In a LAN that uses a DNS server, each PC or instrument connected in the LAN can be accessed via an unambiguous computer name (*hostname*) instead of the IP address. The DNS server translates the hostname to the IP address. It is especially useful when a DHCP server is used, as a new IP address can be assigned each time the instrument is restarted.

Each instrument is delivered with an assigned computer name, that remains permanent as long as it is not explicitly changed.

The default computer name follows the syntax <INST>-<Serial Number> (previous syntax: rs<inst><Serial Number>), where:

- <INST> is the short name of your instrument, as stated on the front panel.
- <Serial Number> is the individual serial number of the instrument.
You can find the serial number at the rear panel of instrument. It is the third part of the device ID printed on the barcode sticker .



Example:

The default hostname of an R&S SMBV100B with a serial number 102030 is SMBV100B-102030.

To query and change a computer name

1. Press the [Setup] key.
2. Select "Remote Access > Network".
The computer name is displayed under "Hostname".
3. Press the [Setup] key.
4. Select "Security > Protection".
5. Enable the "Protection Level 1".
The default password is *123456*.
The parameter "Hostname" in the "Network" tab is now enabled for configuration.
6. Change the "Hostname".

2.1.4.3 Assigning the IP Address

Depending on the network capacities, the TCP/IP address information for the instrument can be obtained in different ways.

- If the network supports DHCP (dynamic host configuration protocol), the address information is assigned automatically.
- If the network does not support DHCP, the instrument tries to obtain the IP address via Zeroconf (APIPA) protocol. If this attempt does not succeed or if the instrument is set to use alternate TCP/IP configuration, the addresses must be set manually.

Since the dynamic TCP/IP configuration assigns the address information automatically, it is safe to establish a physical connection to the LAN without any previous instrument configuration.

NOTICE**Risk of network failure**

Consult your network administrator before performing the following tasks:

- Connecting the instrument to the network
- Configuring the network
- Changing IP addresses

Errors can affect the entire network.

To assign the IP address manually on the instrument**Use computer names to identify the instrument**

In networks using a DHCP server, we recommend that you address the instrument by its unambiguous computer name, see [Chapter 2.1.4.2, "Using Computer Names \(Host-names\)"](#), on page 38.

1. Press the [Setup] key.
2. Select "Remote Access > Network".
3. Select "Address Mode > Static".
4. Select the "IP Address".
5. Enter the IP address, for example *192.168.0.1*.

The IP address consists of four number blocks separated by dots. Every block contains 3 numbers in maximum.

6. Select the "Subnet Mask" and enter the subnet mask, for example *255.255.255.0*.

The subnet mask consists of four number blocks separated by dots. Every block contains 3 numbers in maximum.

To assign the IP address manually on the computer

- ▶ Obtain the necessary information from your network administrator. If you use more than one LAN connector, you need separate address information for each connector.

For information on how to perform the configurations, refer to the documentation of the operating system the computer uses.

2.2 Instrument Tour

The following topics help you get familiar with the instrument and perform the first steps:

- [Front Panel Tour](#)

- [Rear Panel Tour](#)

This section explains the control elements and the connectors of the R&S SMBV100B with the aid of the front and rear views. For specifications of the interfaces, refer to the data sheet.

2.2.1 Front Panel Tour

This section provides an overview of the control elements and connectors on the front panel of the R&S SMBV100B. On the rear panel, you find all further connectors of the unit, see [Chapter 2.2.2, "Rear Panel Tour"](#), on page 47. The user interface can be displayed on a remote PC station used to manually remote control the instrument.



Figure 2-1: Front panel view

- 1 = Touchscreen, see [Chapter 2.2.1.1, "Touchscreen"](#), on page 41
- 2 = Utility keys, see ["Utility Keys"](#) on page 43
- 3 = [On/Standby], see ["On/Standby"](#) on page 43
- 4 = Function keys, see ["Function Keys"](#) on page 44
- 5 = Keypad, see ["Keypad"](#) on page 44
- 6 = Navigation controls, see ["Navigation Controls"](#) on page 45
- 7 = USB connectors, see [Chapter 2.2.1.3, "Connectors"](#), on page 46
- 8 = Sensor connector, see [Chapter 2.2.1.3, "Connectors"](#), on page 46
- 9 = User x input/output connectors, see [Chapter 2.2.1.3, "Connectors"](#), on page 46
- 10 = RF output connectors, see [Chapter 2.2.1.3, "Connectors"](#), on page 46

2.2.1.1 Touchscreen

The block diagram and the most important settings are displayed on the screen on the front panel. Additionally, the screen display provides status and setting information and allows you to quickly reconfigure the signal flow. The screen is touch-sensitive, offering an alternative means of user interaction for quick and easy handling of the instrument.

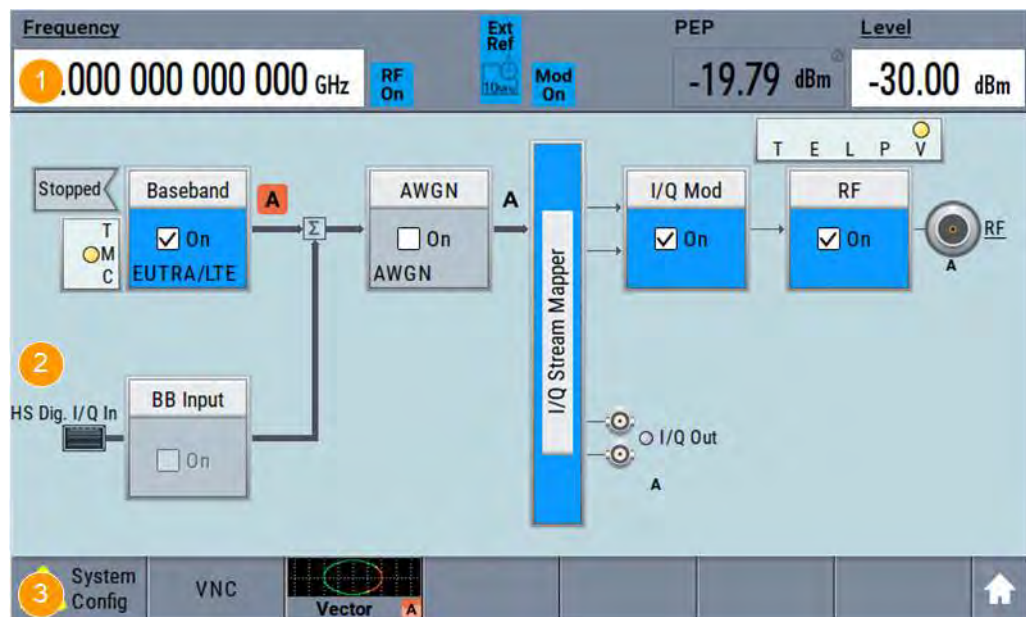

Figure 2-2: Touchscreen elements

- 1 = Status bar (frequency and level display)
- 2 = Block diagram
- 3 = Taskbar/softkey bar

A touchscreen is a screen that is touch-sensitive. It reacts in a specified way when a particular element on the screen is tapped by a finger. Any user interface element that can be clicked by a mouse pointer can also be tapped on the screen to trigger the same behavior.

Using the touchscreen, the following tasks (among others) can be performed by the tap of your finger:

- Changing a setting
- Selecting new settings
- Scrolling through the list of parameters
- Saving or recalling settings
- Opening and closing dialogs



To imitate a right-click by mouse using the touchscreen, for example to open a context-sensitive menu for a specific item, touch and hold the screen for about 1 second.

NOTICE**Risk of touchscreen damage**

Inappropriate tools or excessive force can damage the touchscreen.

Observe the following instructions when operating the touchscreen:

- Never touch the screen with ball point pens or other sharp objects, use your fingers instead.
As an alternative, you can use a stylus pen with a smooth soft tip.
- Never apply excessive force to the screen. Touch it gently.
- Never scratch the screen surface, for example with a finger nail.
- Never rub the screen surface strongly, for example with a dust cloth.
For instructions on cleaning the screen, see [Chapter 13.1, "Cleaning"](#), on page 919.

2.2.1.2 Keys**Utility Keys**

The utility keys cause the R&S SMBV100B to return to a defined instrument state and provide information on the instrument and assistance.

For more information, refer to [Chapter 10, "General Instrument Functions"](#), on page 480.

Table 2-1: Utility keys

Utility Key	Assigned functions
[Preset]	Sets the instrument to a defined state
[Save/Rcl]	Saves and loads instrument setting Accesses the file manager
[Local]	Switches from remote control to local (manual) control
[Setup]	Accesses the general instrument settings
[Help]	Displays context-sensitive help text

On/Standby

The [On/Standby] key switches the instrument from the standby to the ready state or vice versa.

- In the ready state, the LED is green. The instrument is ready for operation.
- In the standby state, the LED is orange. The standby power mode keeps the power switch circuits and the oven-controlled crystal oscillator OCXO active. In this state, it is safe to switch off the AC power and disconnect the instrument from the power supply.

Function Keys

Function keys provide access to most common generator settings and functions.

A detailed description of the corresponding functions is provided in the user manual.

Table 2-2: Function keys

Function key	Assigned functions
[Freq]	Activates frequency entry.
[Level]	Activates level entry.
[Home]	Brings the block diagram to the foreground. Active dialogs are minimized.
[RF on/off]	Switches the RF output on and off. Press the key again to restore the last active status. Status is displayed in the "Status bar".
[Mod on/off]	Switches the modulations on and off. Press the key again to restore the last active status. Status is displayed in the "Status bar".
[★ (User)]	Key with a customizable function.

Keypad

The keypad is used to enter alphanumeric parameters, including the corresponding units. It contains the following keys:

Table 2-3: Keys on the keypad

Type of key	Description
Alphanumeric keys	Enter numbers and (special) characters in edit dialog boxes.
Decimal point	Inserts a decimal point "." at the cursor position.
Sign key	Changes the sign of a numeric parameter. In the case of an alphanumeric parameter, inserts a "-" at the cursor position.
Unit keys (G/n dB μ V, M/ μ μ V, k/m mV and x1 dB(m))	These keys add the selected unit to the entered numeric value and complete the entry. In the case of level entries (e.g. in dB) or dimensionless values, all units have the value "1" as multiplying factor. Thus, they have the same function as an [Enter] key.

Editing Keys

Editing keys enable you to confirm an entry, delete individual characters, or exit the current operation.

Table 2-4: Editing keys

Type of key	Description
[Esc] key	Closes all kinds of dialog boxes, if the edit mode is not active. Quits the edit mode, if the edit mode is active. In dialog boxes that contain a "Cancel" button it activates that button. For "Edit" dialog boxes the following mechanism is used: <ul style="list-style-type: none"> • If data entry has been started, it retains the original value and closes the dialog box. • If data entry has not been started or has been completed, it closes the dialog box.
[Enter] key	Has the same effect as pressing the rotary knob <ul style="list-style-type: none"> • Concludes the entry of dimensionless entries. The new value is accepted. • With other entries, this key can be used instead of the default unit key. • In a dialog box, selects the default or focused element. • Calls the next dialog level. • Confirms and closes open input windows.
[Backspace] key	Deletes the character to the left of the cursor in editing mode.

Navigation Controls

The navigation controls include a rotary knob, navigation keys, and the display keys. They allow you to navigate within the display or within dialog boxes.

Rotary Knob

The rotary knob has several functions:

- Increments (clockwise direction) or decrements (counterclockwise direction) the instrument parameter at a defined step width in the case of a numeric entry.
- Moves the selection, e.g. to a function block in the block diagram
- Shifts the selection bar within focused areas (e.g. lists).
- Acts like the [Enter] key, when it is pressed.

Navigation Keys

The navigation keys can be used alternatively to the rotary knob to navigate through dialog boxes, diagrams, or tables.

Table 2-5: Navigation keys

Type of key	Description
[Up/Down] Key	The [Up] and the [Down] key does the following: <ul style="list-style-type: none"> • In a numeric edit dialog box, increase or decrease the instrument parameter. • In a list, scroll forward and backward through the list entries. • In a table, move the selection bar vertically. • In windows or dialog boxes with vertical scrollbar, move the scrollbar.
[Left/Right] Key	The [Left] and the [Right] key does the following: <ul style="list-style-type: none"> • In an alphanumeric edit dialog box, move the cursor. • In a list, scroll forward and backward through the list entries. • In a table, move the selection bar horizontally. • In windows or dialog boxes with horizontal scrollbar, move the scrollbar.

Display Keys

The display keys arrange different windows on the display.

Table 2-6: Display keys

Display key	Assigned functions
[Next window]	Toggles between the active dialogs
[Home]	Shows the block diagram.
[Next window]	Toggles between the open dialogs.
[On/Off Toggle]	<ul style="list-style-type: none"> • Switches highlighted elements or a function block on and off. • Switches between two or more settings, e.g. items of selection lists. At the end of a list, the cursor is set on the first entry again.
[Undo]	Reverts the last operation.
[★ (User)]	Key with a customizable function.

2.2.1.3 Connectors

The RF connector and various others interface connectors are on the front panel.

USB

USB (universal serial bus) interfaces of type A (host USB).

- Connection of peripherals such as mouse or keyboard
- Connection of memory stick for file transfer
- Firmware update

Note: Further USB interface type A (host USB) and a USB interface type B (USB In) are available on the rear panel.

See also [Chapter 2.1.3, "Connecting USB Devices"](#), on page 36.

Sensor

Connector for R&S NRP sensors.

A power sensor is connected to the R&S SMBV100B by inserting the male connector. To disconnect, pull the connector by its sleeve. You cannot disconnect the sensor simply by pulling at the cable or the rear part of the connector.

The R&S SMBV100B supports the use of R&S NRP power sensors in various ways including the use as a power viewer.

See [Chapter 6.12.4, "Using Power Sensors"](#), on page 363 and [Chapter 6.12.3, "User Correction"](#), on page 352.

User x

Multipurpose connectors. The input/output signal has to be defined.

The [Table 2-7](#) lists the signals assigned to the User x connectors in the default instrument state.

Table 2-7: Default configuration of the User x connectors

User connector	Direction	Default assigned signal
1	Output	Baseband Marker 1
2	Output	Baseband Marker 2

See [Chapter 10.2, "Configuring the Global Connectors"](#), on page 486.

RF

Output for RF signal.

NOTICE! Maximum input levels. Do not overload the RF output. The maximum permissible back-feed is specified in the data sheet.

The connector type depends on the installed frequency option, see [Table 2-8](#).

Table 2-8: Overview of RF connector types depending on the frequency range

Required option	Connector type
R&S SMBVB-B103/-KB106	N female

NOTICE! Risk of RF connector and cable damage. If you tighten the connectors too strongly, you can damage the cables and connectors. If you do not tighten the connectors enough, the measurement results can be inaccurate.

Always use an appropriate torque wrench suitable for this type of connector and apply the torque specified in the application note [1MA99](#).

The application notes are available on the Internet and provide additional information on care and handling of RF connectors.

Rohde & Schwarz offers appropriate torque wrenches for various connectors. For ordering information, see the R&S SMBV100B data sheet or product brochure.

2.2.2 Rear Panel Tour

This section provides an overview of the connectors on the rear panel of the instrument. For technical data of the connectors, refer to the data sheet.

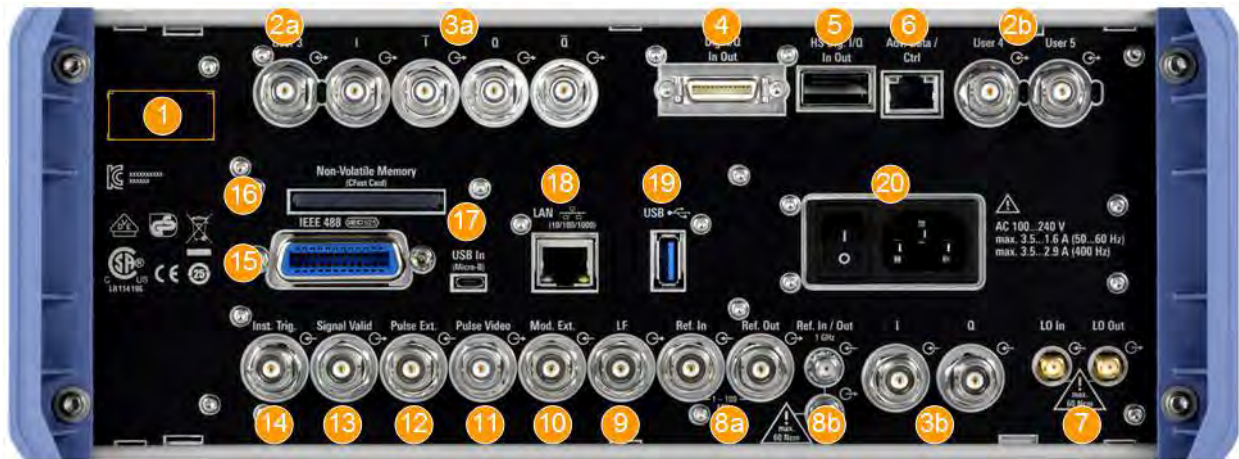

Figure 2-3: Rear panel

- 1 = Serial number (six digits in the string 1423.1003.02-<serial number>-<checksum>)
- 2a, 2b = User x connectors
- 3a = I/Q, I/Q Bar connectors (output)
- 3b = I/Q connectors (input)
- 4 = Dig I/Q connector
- 5 = HS Dig I/Q connector
- 6 = Adv Data/Ctrl connector (provided for future use)
- 7 = LO In/LO Out connectors
- 8a = Ref In/Ref Out connectors
- 8b = Ref In/Ref Out 1GHz connectors
- 9 = LF connector
- 10 = Mod Ext connector
- 11 = Pulse Video connector
- 12 = Pulse Ext connector
- 13 = Signal Valid connector
- 14 = Inst Trig connectors
- 15 = IEC 625/IEEE 488 connector
- 16 = Non-Volatile Memory
- 17, 19 = USB/USB In connectors
- 18 = LAN connector
- 20 = AC power supply connection and main power switch

2.2.2.1 Connectors

User x

Multipurpose connectors. The input/output signal has to be defined.

The [Table 2-9](#) lists the signals assigned to the User x connectors in the default instrument state.

Table 2-9: Default configuration of the User x connectors

User connector	Direction	Default assigned signal
3	Input	Global Trigger
4	Input	Global Next Segment
5	Output	Baseband Sync Out

A dedicated LED indicates the connector status:

- Green: an input connector
- Yellow: an output connector
- No light: the connector is not active

See [Chapter 10.2, "Configuring the Global Connectors"](#), on page 486.

I/Q, I/Q Bar

Direct (single-ended) or differential output for the analog I/Q signal.

See also [Chapter 8.7, "I/Q Analog Output Settings"](#), on page 435.

Dig I/Q

Connectors for the input of a digital I/Q signal from a Rohde & Schwarz instrument, like a signal generator.

HS Dig I/Q

Connectors for the input of high-speed digital I/Q signals, for example, from Rohde & Schwarz instruments.

For more information, see data sheet.

The interface is a QSFP+ (Quad Small Form-factor Pluggable) module. It supports max. bandwidth of up to 50 Gsample/s with optical active cables.

NOTICE! Risk of damaging the HS DIG I/Q interface.

Use active optical QSFP+ cable with max. power class 2 module (2.0 W max. power consumption).

- To plug in the cable:
Hold the QSFP+ plug by its panes. The release tab must be upwards oriented. Insert it in the HS Dig I/Q cage and push it.
- To disconnect the cable:
Do not pull the cable itself. Pulling the cable can damage the cable and the HS Dig I/Q connector.
Pull the release tab and pull the connector out of the HS Dig I/Q connector.

See also:

- [Chapter 8.6, "Digital Baseband Input Settings"](#), on page 426.

Adv Data/Ctrl

Interface for exchanging of external data and control signals.

LO In/LO Out

Option: R&S SMBVB-K90

Local oscillator input and output for phase-coherent RF signal:

- LO In: Input of phase coherence signal
- LO Out: Output of phase coherence signal

NOTICE! Risk of damaging components. Always use an appropriate 8 mm torque wrench to tighten SMA connectors. Limit the tightening torque to 60 Ncm. Never use an open-end wrench.

See [Chapter 6.9, "Local Oscillator Coupling"](#), on page 279.

I/Q

I and Q inputs for external analog modulation signal directly fed into the I/Q modulator. For more information, see [Chapter 8.4.1.4, "Overview of the Input and Output Signals and Interfaces"](#), on page 407.

Ref In/Ref Out

Input/output for external reference signal.

Incl. dedicated connectors for the 1GHz reference signal.

See [Chapter 6.8, "Reference Oscillator"](#), on page 272.

LF

Output for internal LF generator signal.

See also data sheet and user manual, section "Analog Modulation".

Mod Ext

Input for external analog modulation signals.

See [Chapter 6.11, "Analog Modulations"](#), on page 319.

Pulse Video

Output of the internal pulse generator signal or the looped through pulse signal from Pulse Ext connector (video signal).

See [Chapter 6.11.4.1, "Pulse Modulation"](#), on page 322.

Pulse Ext

Input for an external pulse modulation signal or an external trigger/gate signal for the pulse generator.

Signal Valid

Output signal that marks the valid signal times (valid level and frequency) for all analog modulations.

Inst Trig

Input for external trigger of sweeps and list mode.

For detailed information on the sweep modes and the triggering, see [Chapter 6.10.1, "Signal Generation and Triggering in the Sweep and List Modes"](#), on page 286.

IEC 625/IEEE 488

GPIB-bus interface for remote control of the instrument.

The IEC 625 interface is in compliance with IEEE488 and SCPI. A computer for remote control can be connected via this interface. To set up the connection, we recommend that you use a shielded cable.

Note: To avoid electromagnetic interference (EMI) caused by open lines, always terminate any connected IEC-bus cable with an instrument or a controller.

See also [Chapter B.1, "GPIB-Bus Interface"](#), on page 975 and [Chapter 11, "Network Operation and Remote Control"](#), on page 520.

Non-Volatile Memory

Option: R&S SMBVB-B80

Slot for removable mass storage.

USB/USB In

- Female USB type A connector, to connect devices like a keyboard, a mouse, a memory stick, or the R&S NRP-Z3/Z4 cable for the R&S NRP power sensors
- Female USB In connector (USB type B), for example for remote control.

See also [Chapter 2.1.3, "Connecting USB Devices"](#), on page 36.

LAN

The LAN interface can be used to connect the R&S SMBV100B to a local network for remote control, remote operation, and data transfer.

For details, see [Chapter 2.1.4, "Setting Up a Network \(LAN\) Connection"](#), on page 37.

AC supply and power switch

The AC power supply connector and the main power switch are located in a unit on the rear panel of the instrument.

Main power switch function:

- Position 1: The instrument is in operation.
- Position 0: The entire instrument is disconnected from the AC power supply.

For details, refer to [Chapter 2.1.1.6, "Turning the Instrument On and Off"](#), on page 32.

2.3 Trying Out the Instrument

This chapter introduces the most important functions and settings of the R&S SMBV100B step by step. The complete description of the functionality and its usage is given in the R&S SMBV100B user manual. Basic instrument operation is described in [Chapter 2.5, "Instrument Control"](#), on page 73.

Prerequisites

- The instrument is set up, connected to the power supply, and started up as described in [Chapter 2.1, "Preparing for Use"](#), on page 28.

For the first signal generation tasks, you use the internal baseband and reference signal, so you do not need any additional signal source. More complex signal generation tasks, however, require an instrument equipped with additional options and/or external signals. Each task description lists its prerequisites.



The screenshots in this description show a fully equipped instrument. Consider that, the block diagram displayed on your particular instrument can differ from the one used in the example.

The instrument is manually operated via the touchscreen. Try out the following:

- [Generating an Unmodulated Carrier](#).....52
- [Generating a Digitally Modulated Signal](#).....53
- [Triggering the Instrument with an External Signal](#).....56
- [Enabling and Configuring a Marker Signal](#).....60
- [Verifying the Generated Signal with the Graphics Display](#).....61
- [Saving and Recalling Settings](#).....64
- [Generating an EUTRA/LTE Signal](#).....67

2.3.1 Generating an Unmodulated Carrier

We start out by generating a simple unmodulated signal. The R&S SMBV100B in this example can be a base unit in its minimal configuration (i.e. with installed R&S SMBVB-B103).

1. On the R&S SMBV100B front panel, press the Preset key to start out in a defined instrument configuration.
2. Set the frequency:
 - a) On the "Status Bar", tap the "Frequency" field.
 - b) On the on-screen keypad, enter 1.955 and press the "GHz" key.

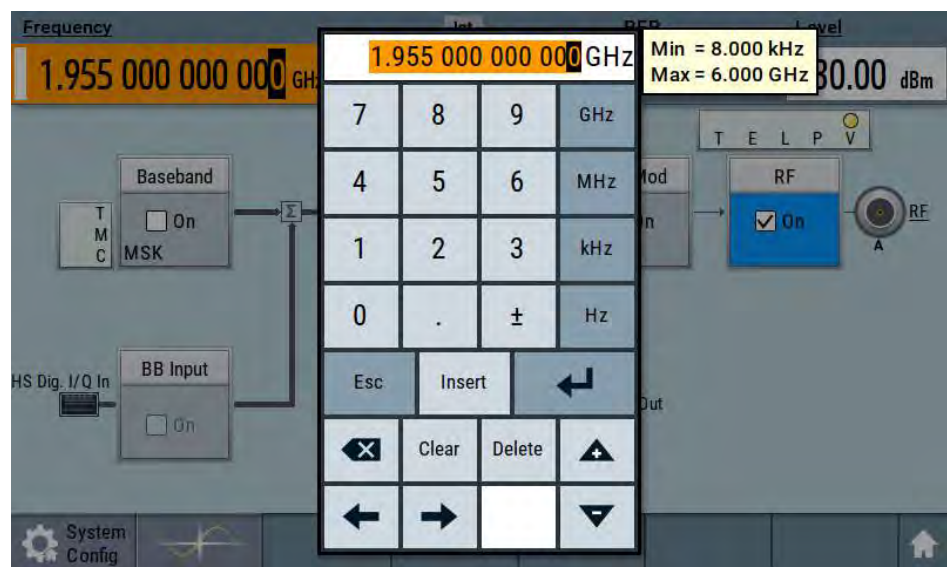

The on-screen keypad closes and the frequency value is displayed.

3. On the "Status Bar", tap the "Level" field and enter the level in the same way.

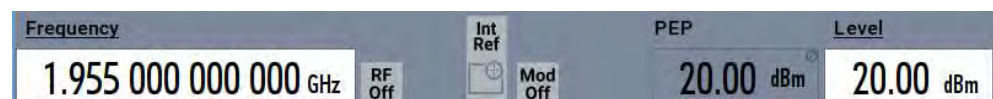

4. Select "Block Diagram > RF Block > On" to enable the output of the generated unmodulated signal.

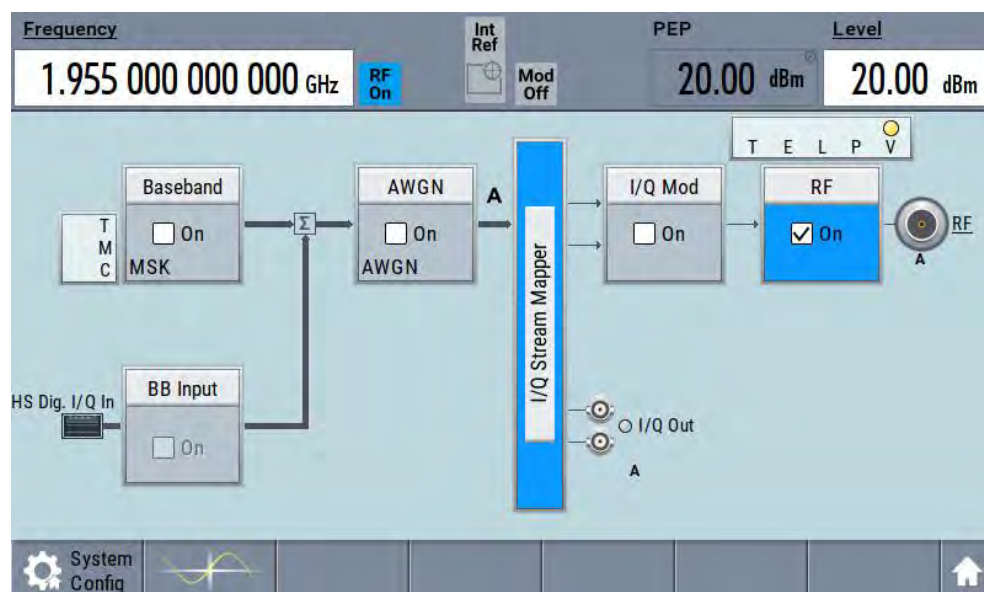

Figure 2-4: Block diagram: Generating an unmodulated signal

The 1.95 GHz signal is output at the RF connector at the front panel of the R&S SMBV100B.



Connect RF of the R&S SMBV100B to a signal analyzer, for example R&S®FSW, to display the generated signal.



Figure 2-5: Simplified test setup

For the required settings of the signal analyzer, refer to its user manual or its online help.

2.3.2 Generating a Digitally Modulated Signal

This example shows you how to generate a simple WCDMA-3GPP (QPSK 45° offset) signal with the help of the "Custom Digital Modulation" functionality.

The minimum requirement for R&S SMBV100B in this example is a base unit equipped with:

- Option custom digital modulation R&S SMBVB-K520
- Option frequency R&S SMBVB-B103.

The initial situation is not the instrument's preset state but rather the configuration described in [Chapter 2.3.1, "Generating an Unmodulated Carrier"](#), on page 52.

1. In the block diagram, select "Baseband" and navigate to the section "Misc > Custom Digital Mod...".

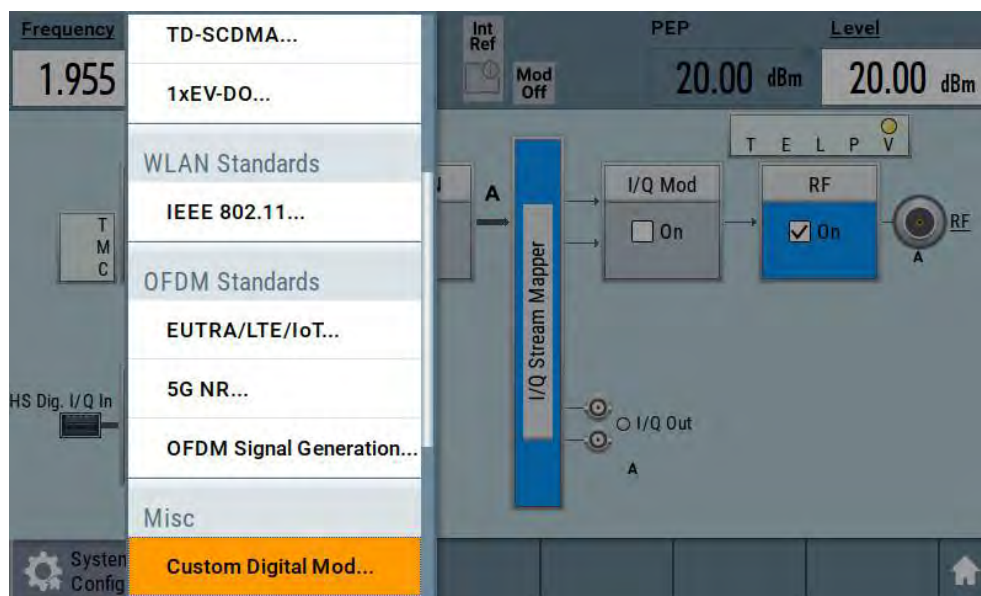

The "Custom Digital Modulation" dialog opens.

2. In the "Custom Digital Modulation" dialog, select "General > Set according to Standard > WCDMA-3GPP".
3. Select "General > State > On" to enable signal generation.

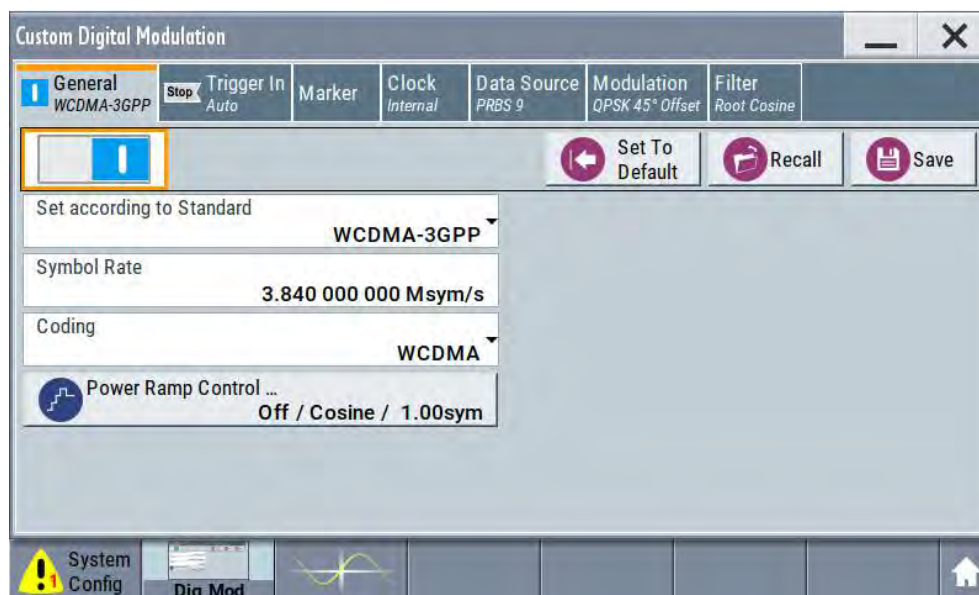

4. Select the "Modulation" tab and observe the used "Modulation Type".

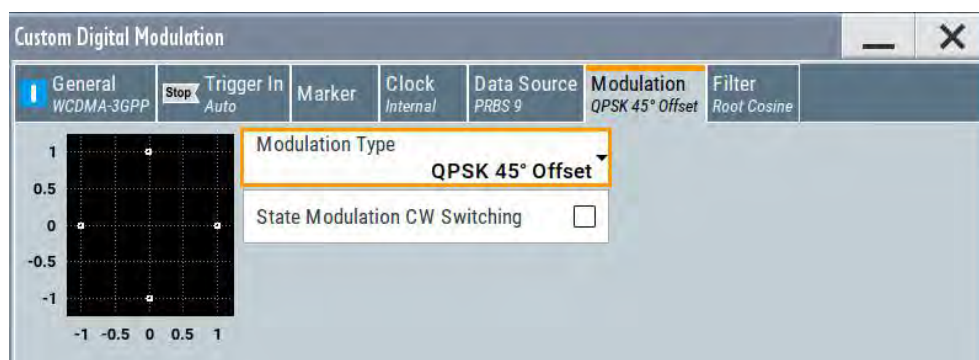

Figure 2-6: Display of the used modulation type

The instrument activates automatically "I/Q Mod", uses the internal trigger and clock signals, and generates a WCDMA-3GPP signal, modulated with a QPSK 45° offset modulation.

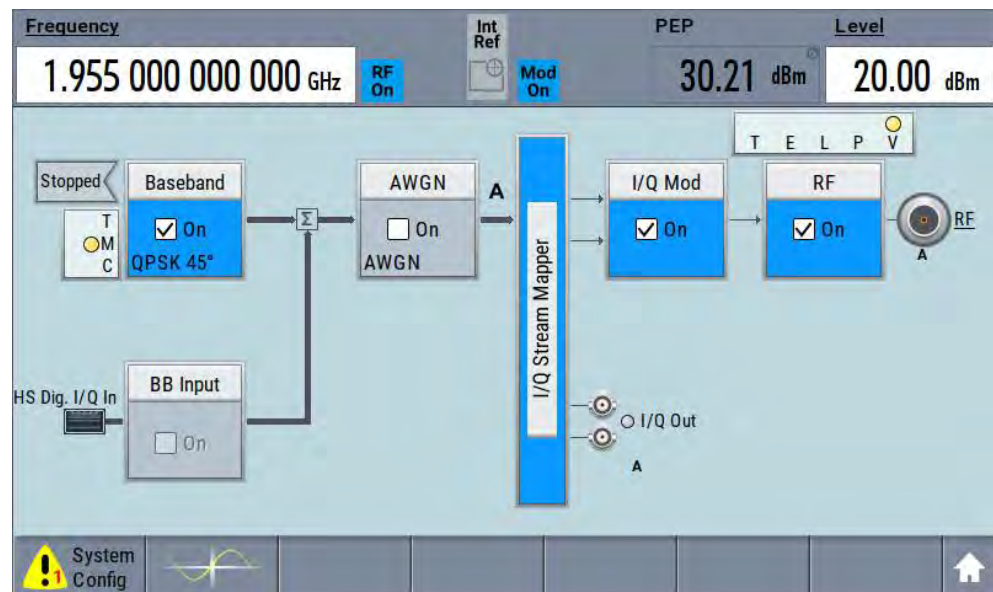

Figure 2-7: Block diagram: Generating a digitally modulated signal

2.3.3 Triggering the Instrument with an External Signal

The example configurations are rather theoretical cases, because you rarely use the R&S SMBV100B as a standalone instrument. Usually, the instrument would be connected to a device under test (DUT) and/or other measurement equipment. As a rule, whenever a test setup requires two or more devices, provide them with a common reference frequency. Some test setups require control of the signal generation start and an exact generation start time, determined by a defined trigger event. For example, by triggering the instrument internally or externally from the DUT.

This example illustrates the general principle of external triggering and extends the configuration performed in [Chapter 2.3.2, "Generating a Digitally Modulated Signal"](#), on page 53 by the configuration of the required trigger signal and connector settings.

This test setup requires one signal analyzer, like the R&S®FSW, as additional equipment.

To start the signal generation synchronous to an external global trigger signal

The configuration requires three main steps with the following goals:

1. Observe the current connector configuration. Define an input connector for the external global trigger signal.
See ["To verify the current connector configuration"](#) on page 57
2. Configure the baseband to use this external global trigger signal as trigger source.
See ["To reconfigure the trigger settings"](#) on page 58
3. Connect the instrument and the external trigger source.
See ["To connect the instrument and the external trigger source"](#) on page 60

To verify the current connector configuration

The R&S SMBV100B is equipped with multipurpose bi-directional User connectors. Because the signal direction, input or output, and the signal mapping are configurable, we recommend that you check the current configuration before cabling or further instrument's configurations.

- To display *an overview* of the current mapping of the logical signals to the connectors, perform one of the following:
 - In the block diagram, select the Trigger/Marker/Clock status LEDs on the left side of the "Baseband" block.



- Select "Baseband > Trigger Marker Clock".

	Logical Signal	Connector	Show
Trigger Source	Internal		
Clock Source	Internal		
Clock Output			
Marker 1	On/Off Ratio	User 1	
Marker 2	On/Off Ratio	User 2	
Marker 3	On/Off Ratio		

Diagram Legend
 T =Trigger =Common to all Basebands
 M=Marker
 C =Clock
 ●=Signal is available at Output Connector
 ●=Signal Source is external

Global Connector Settings ...

The instrument uses its internal trigger and clock signals, and the default mapping of the marker signals to the connectors.

- To access the related connector settings, perform one of the following:
 - Select "Global Connector Settings"
 - Tap the connector name, for example select the connector "User 1"

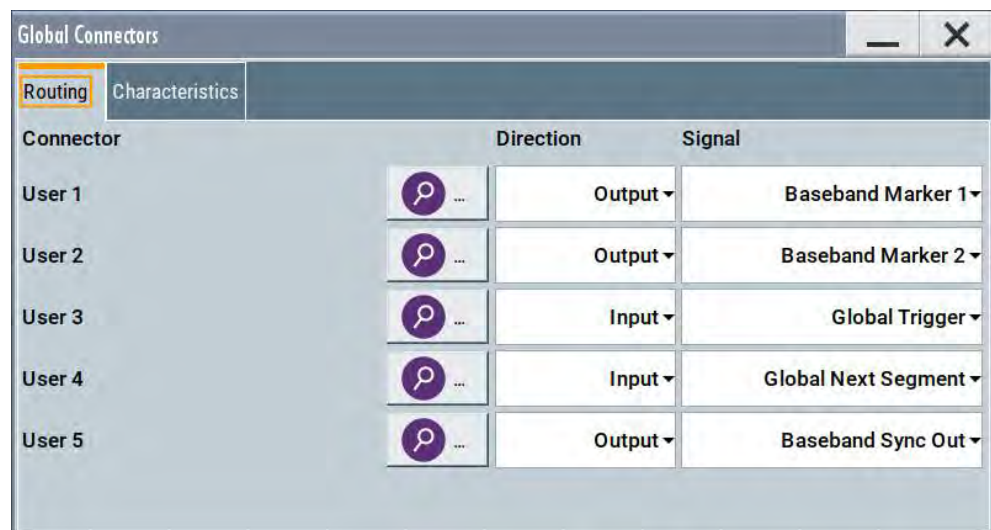

Figure 2-8: Signal mapping to the global connectors

The "Global Connectors" dialog displays the current connectors configuration. The settings are configurable, but in this example we use the default mapping.

- Alternatively, select "Block Diagram > Baseband > Misc > Custom Digital Mod", select the "Trigger In" tab and select "Global Connector Settings".

In the current mapping, the two global connectors **User x** on the front panel are configured as follows:

- "Marker 1/2" are output at the User 1/2 connectors
- The User 3 connector is an input for the "Global Trigger" signal.



Find the physical location of each connector

Use the built-in "Trigger Marker Clock > Show " function to display the location of the selected connector. A blinking marker on the front/rear panel view also indicates the selected connector.

To reconfigure the trigger settings

We assume that the instrument is configured as described in [Chapter 2.3.2, "Generating a Digitally Modulated Signal"](#), on page 53 and the default connector mapping is maintained (see [Figure 2-8](#)).

- In the block diagram, select "Baseband > Misc > Custom Digital Mod > Trigger In".
- Select the following settings:
 - "Mode > Armed Auto"
 - "Source > External Global Trigger".

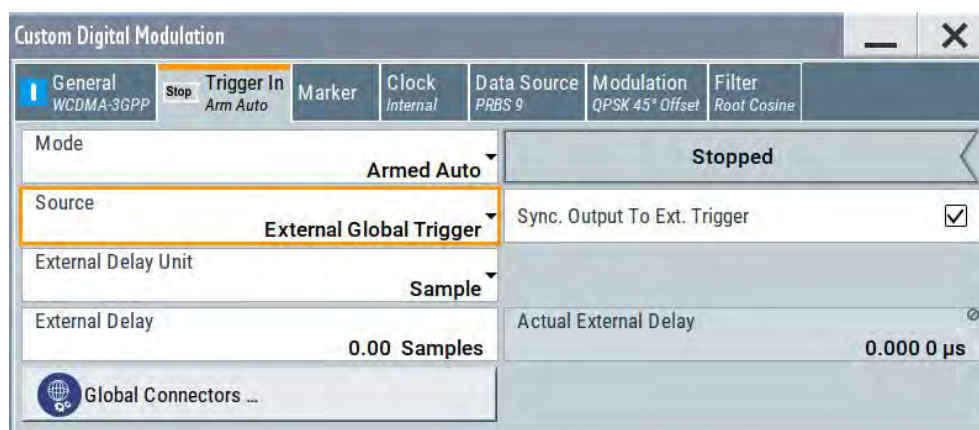

3. Select "Global Connector Settings > Routing".
4. For "User 2", select "Direction > Input" and "Signal > Global Trigger".

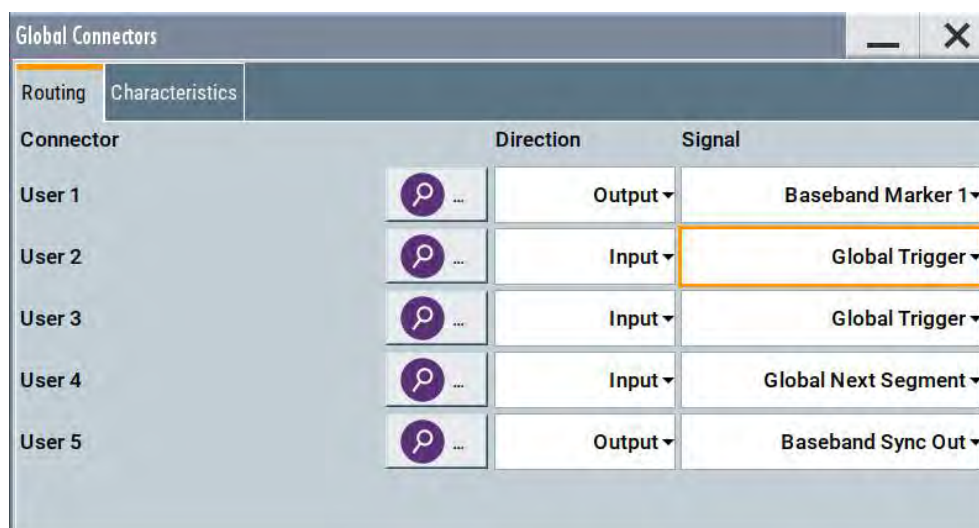

The instrument expects an external global trigger event. In the current configuration, the "Global Trigger" signal has to be supplied at the input connector User 2. The Trigger/Marker/Clock status LEDs in the block diagram confirm that an external trigger signal is selected; the signal generation is however stopped.

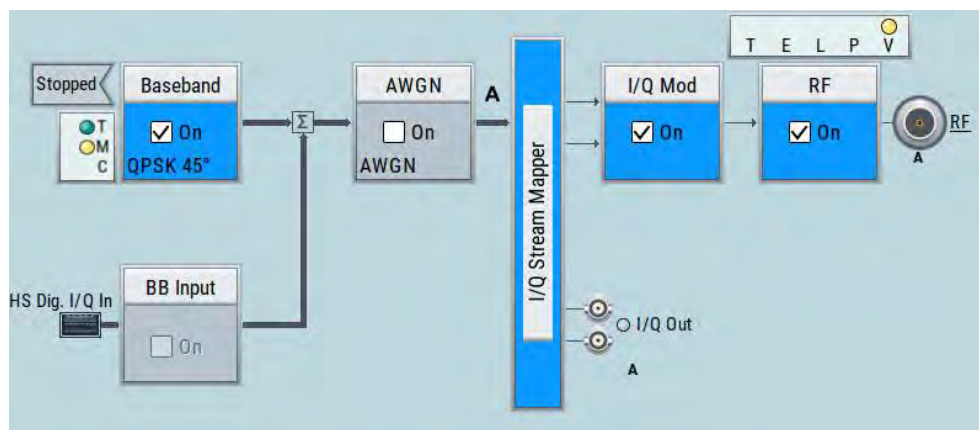

To connect the instrument and the external trigger source

1. Use a suitable cable to connect the external trigger source to the User 2 connector of the R&S SMBV100B. See [Figure 2-9](#).

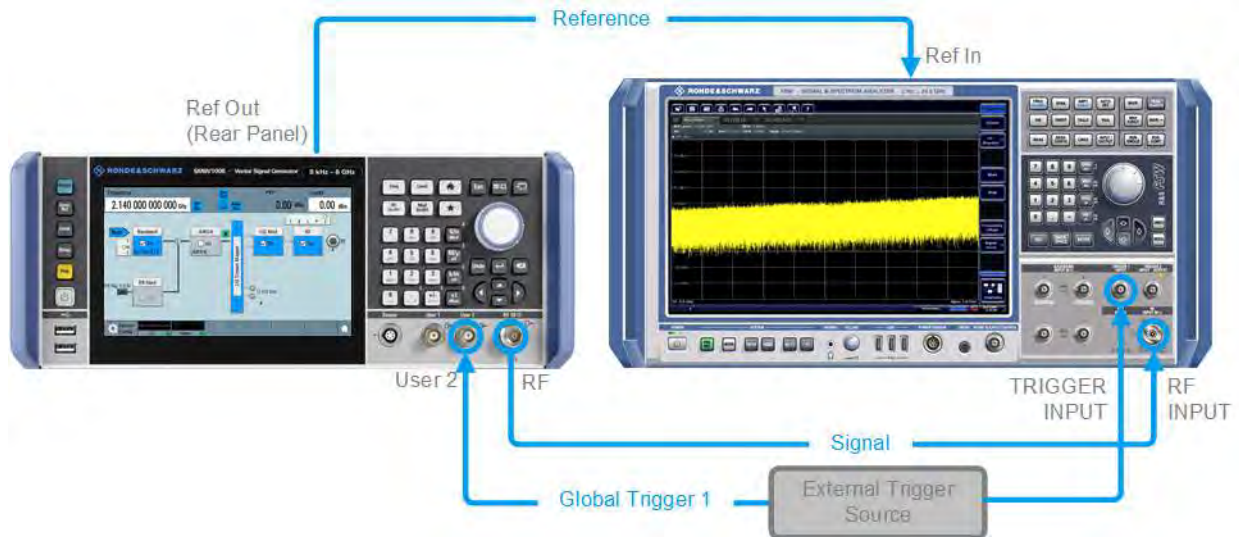

Figure 2-9: Simplified representation of a test setup**

** = The figure depicts the cabling as a general principle; particular test setups do not require all connections at the same time

The [Figure 2-9](#) depicts the location of the connectors and explains the connection as principle. In practice, you would rather "substitute" the analyzer by a DUT, like a base station (BS). Other than in the example, the DUT can be the source for the reference signal. Instead of using an external trigger source, the DUT can also send, for example, a frame trigger signal to the R&S SMBV100B. The R&S SMBV100B acts still as the signal source.

2. Use suitable cables to connect the **RF** and **REF OUT** connectors of the R&S SMBV100B to the signal analyzer or the DUT.

Upon the receiving of an external trigger event, the R&S SMBV100B starts the signal generation and then generates a continuous signal. An "Arm" stops the signal generation. A subsequent trigger event causes a restart of the signal generation.



To learn more about this topic, refer to:

- [Chapter 3.4.1.3, "Baseband Trigger Signals"](#), on page 96
- [Chapter 6.9, "Local Oscillator Coupling"](#), on page 279

2.3.4 Enabling and Configuring a Marker Signal

Test setups often require that an external device is synchronized to the generated data stream. For this purpose, the R&S SMBV100B can output marker signals (or markers) also to the generated signal. The R&S SMBV100B provides several regular marker

signals and marker signals specific to the firmware option. With suitable marker settings for instance, you can mark slot or frame boundaries or mark the start of a particular modulation symbol.

This example extends further the configurations performed in [Chapter 2.3.2, "Generating a Digitally Modulated Signal"](#), on page 53. We assume a default connector mapping (see [Figure 2-8](#)).

This test setup requires one oscilloscope, like the R&S®RTO, as additional equipment.

1. In the block diagram, select "Block Diagram > Baseband > Misc > Custom Digital Mod > Marker" tab.

2. Select "Marker Mode > Marker 1 > Pulse" and "Divider = 32".

Generated is a periodic marker with marker frequency of 120 KHz. The signal is output at the User 1 connector of the R&S SMBV100B (see [Figure 2-8](#)).

3. Use a suitable cable to connect the User 1 connector of the R&S SMBV100B to the monitoring instrument, for example oscilloscope like R&S®RTO. See [Figure 2-10](#).



Figure 2-10: Simplified representation of a test setup for signal monitoring**

** = The figure depicts the cabling as a general principle

4. Use a suitable cable to connect the **I OUT** connector of the R&S SMBV100B to the monitoring instrument.



To learn more about this topic, refer to [Chapter 3.4.1.2, "Regular Marker Output Signals"](#), on page 94.

2.3.5 Verifying the Generated Signal with the Graphics Display

It is often useful to check the spectra of the configured signals, before you enable the RF output of the instrument.

The R&S SMBV100B provides a build-in function to represent the generated signal on a graphical signal display. We demonstrate this feature by showing the characteristics at one particular point of the signal processing chain. You can, however, display the signal characteristics at other different stages.

This example shows you how to use this graphical display to verify the generated signal. Use the signal generated in [Chapter 2.3.4, "Enabling and Configuring a Marker Signal"](#), on page 60.

To access the graphical signal display functionality

- ▶ Perform one of the following:
 - a) Select "Taskbar > System Configuration > Graphics"



- b) On the "Taskbar", tap the wave icon.

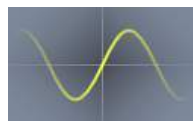

The "Graphics Configuration" dialog opens.

To visualize the signal

1. In the "Graphics Configuration" dialog, select "Mode > Constellation".
2. Select "Source > Baseband".
3. Select "Add" to enable signal display.



A new thumbnail (minimized view) indicating the active diagram appears in the "Taskbar".



4. Press the thumbnail graphic.

The graphic enlarges and the diagram is displayed in a normal size.

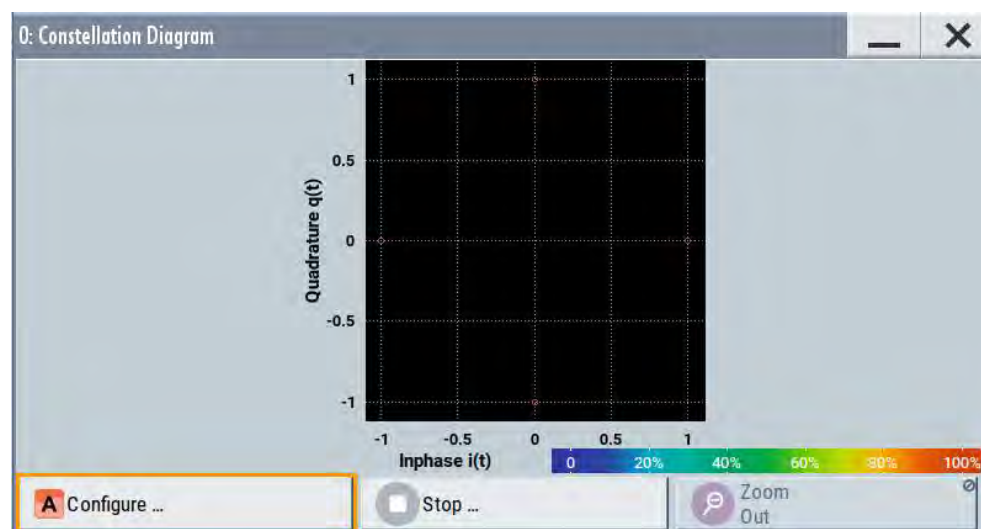

The "Constellation Diagram" displays the 3GPP FDD signal.

5. To retrieve more information, zoom in. In some diagrams you can select "Show Marker" to measure the distance, for example, between two signals. In principle, the zoom in function works like the two-finger pinching for magnifying images on your cellphone.
6. In the "Constellation Diagram" dialog, select "Configure" to return to the "Graphics Configuration" dialog.
Close the "Graphics Configuration" dialog.

This action has no effect on the configured graphics but on the dialog itself.

The block diagram displays the current signal routing. It indicates that frequency and power offsets are enabled and displays the acquisition points for the real-time diagrams minimized in the "Taskbar".

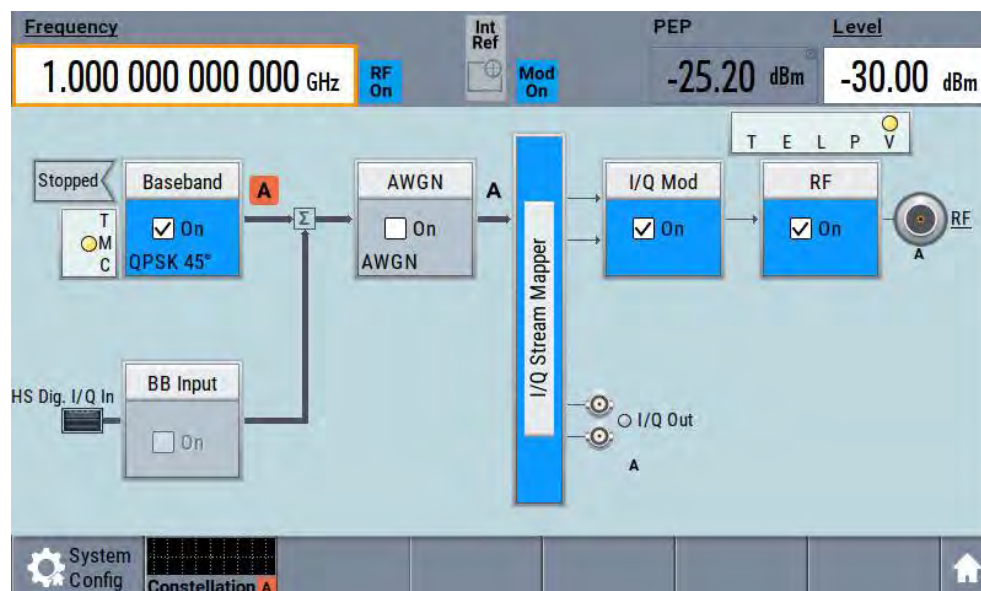

See also [Chapter 7, "Monitoring Signal Characteristics"](#), on page 378.

2.3.6 Saving and Recalling Settings

To restore the results of our measurements later, we save the instrument settings to a file.

To save the instrument settings to a file

We assume, a test configuration as described in [Chapter 2.3.4, "Enabling and Configuring a Marker Signal"](#), on page 60.

1. Press the Save/Rcl key on the front panel.
2. In the "Save/Recall" dialog box, select "Operation Mode > Save".
Tap the "Filename", use the on-screen keyboard, and enter *MyTestSignal*.

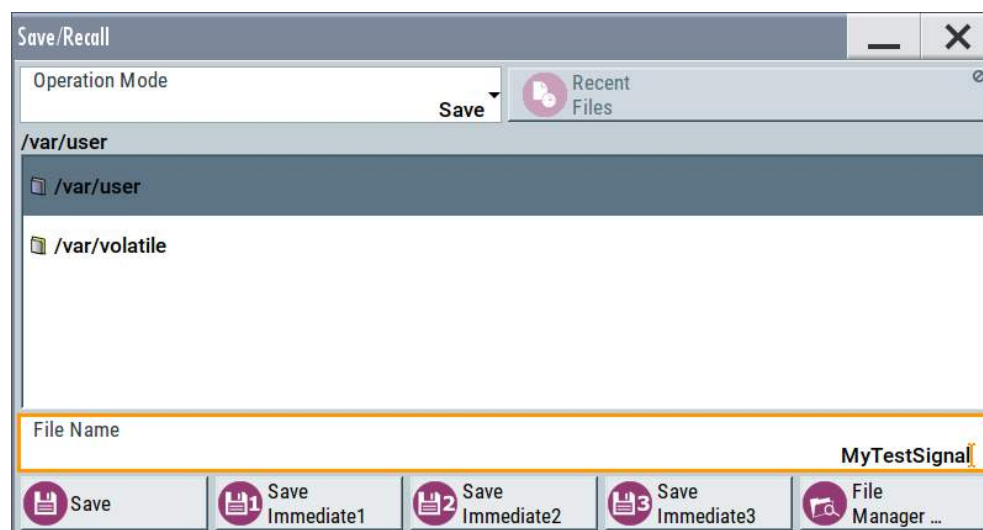

3. Tap the "Save" button.

The file `MyTestSignal.savrc1.txt` is saved in the default directory `/var/user`.

To load saved instrument settings

You can restore the settings to the instrument at any time using the settings file.

1. Press the Preset button to restore the default instrument settings so you can check that the saved user settings are restored afterwards.
2. Press the Save/Rcl key.
3. In the "Save/Recall" dialog, select "Recall" operation.

Navigate to the directory of the saved file. Select the `MyTestSignal` file.

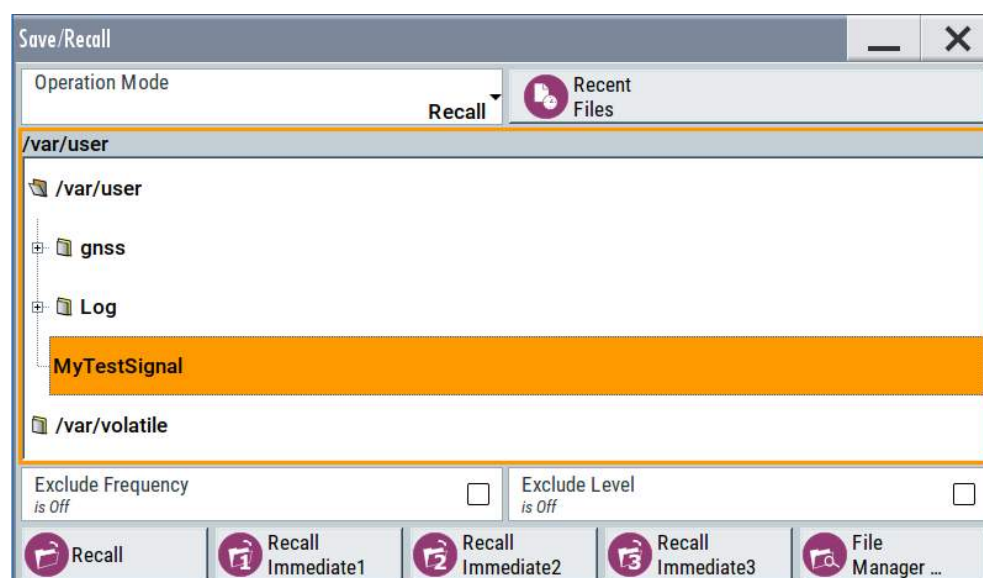

4. Tap the "Recall" button.

All instrument settings are restored and the display resembles the instrument display right before the settings were saved.



How to display all parameters with values different to their preset values

When you load a file to your instrument and do not have enough information on the changed settings, visualize all parameters that have been changed from their default state.

Try out the following:

- Tap and hold on an empty space in the block diagram to access the context-sensitive menu.
- Select "Mark All Parameters Changed from Preset".



- All changed parameters are highlighted.

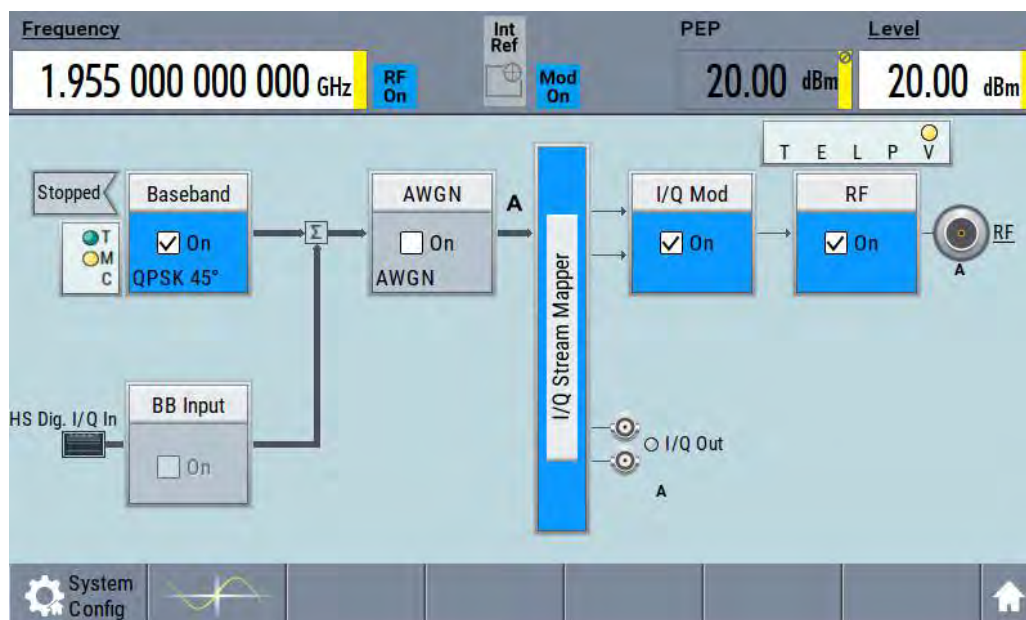

See also [Chapter 9, "File and Data Management"](#), on page 442.

2.3.7 Generating an EUTRA/LTE Signal

The main application field of the R&S SMBV100B is the generation of digital signals in accordance with several telecommunication and wireless standards, like WCDMA, EUTRA/LTE or WLAN, to name a few. This example uses the digital standard EUTRA/LTE to introduce the way you can access and interact with the instrument and experience the advantages provided by the additional options.

The minimum requirement for R&S SMBV100B in this example is a base unit equipped with:

- Option EUTRA/LTE R&S SMBVB-K55
- Option frequency R&S SMBVB-B103

To generate a downlink test signal

The main focus of the following example is not on the R&S SMBV100B capabilities and the features provided by the firmware option. The example aims rather to help you get familiar with the settings and configuration principle common for the digital standards.

We use one of the provided EUTRA test models (E-TM) to show how to generate a test signal upon a quick selection.

1. On the R&S SMBV100B front panel, press the Preset key to start out in a defined instrument configuration.
2. In the block diagram, select "Baseband > Beyond 3G Standards > EUTRA/LTE".

The EUTRA/LTE dialog appears and displays the general settings provided for the digital standard.

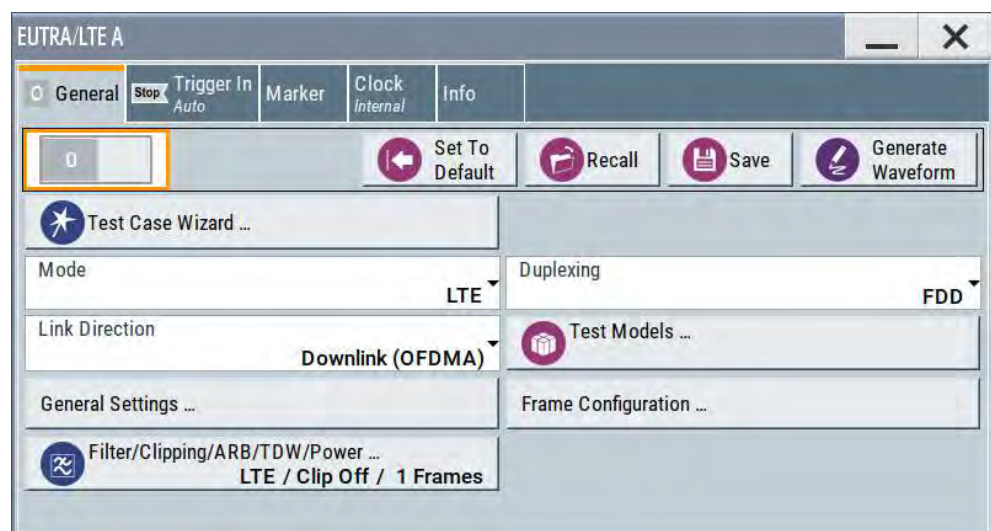

As in the user interfaces of all digital standards, the "EUTRA/LTE" dialog is divided into several tabs. The "General" tab comprises the primary settings of the standard, the functions for storing and recalling settings and provides access to further functions and dialogs, like the "Filter" settings. The "Trigger In", "Marker" and "Clock" tabs comprise the settings related to the corresponding function.

The more complex the digital standard itself is, the more comprehensive the further dialog and tab structure. The start dialog of each digital standard, however, follows a repeating dialog structure that comprises the tabs "General", "Trigger In", "Marker" and "Clock". (See also [Chapter 2.5.3.4, "Additional Display Characteristics"](#), on page 78).

Tip: To display the dialog in its maximal height, press the Resize window key on the front panel.

3. In the "EUTRA/LTE General" tab, select "Test Models".

The test models is a function for quick selection and settings adjustment according to one of the various EUTRA test models (E-TM).

A standard "File Select" function enables you to select form files with predefined settings.



Tip: On the front panel, press the Help key to retrieve detailed information on the current settings and on the contents of the predefined files.

4. Navigate to a file, for example to the E-TM1_1_10MHz (an E-TM1.1 test model with 10 MHz channel bandwidth) and confirm with "Select".

The dialog closes automatically and the user interface confirms the name of the selected file.

5. In the "EUTRA/LTE > General" tab, select "State > On".

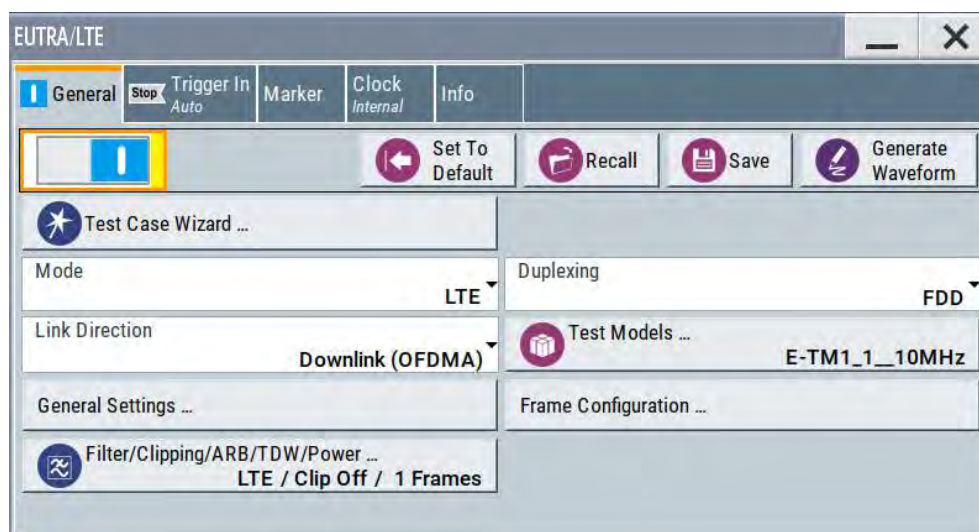

Close the dialog.

- On the "Status Bar", tap the "Frequency" and "Level" fields and enter new values, for example 2.1432 GHz and -20 dBm. Select "RF > On".

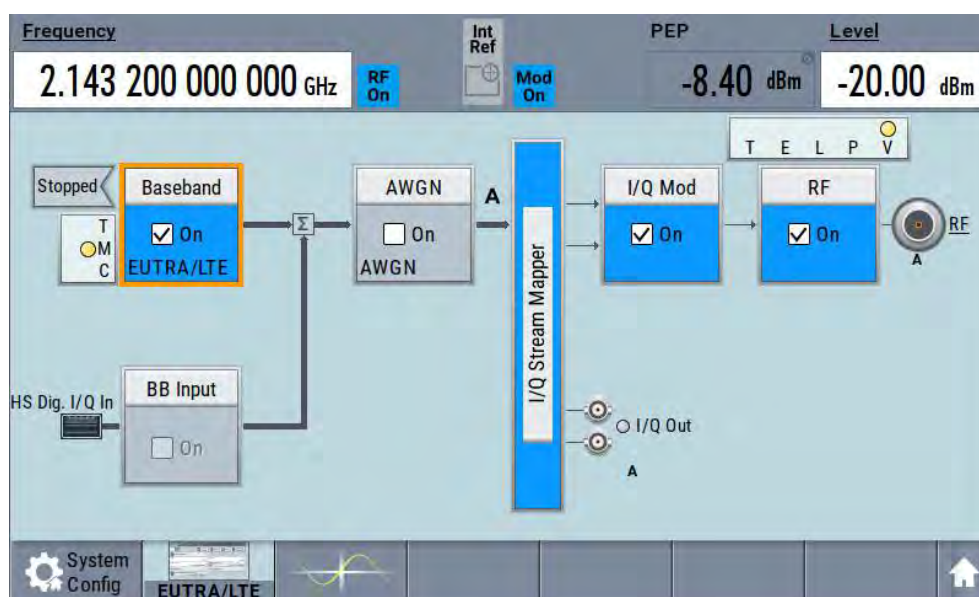

The instrument generates an EUTRA/LTE test signal with the selected channel bandwidth, frequency, and level.



With these first steps, you have gained an impression of the provided functionality. For a comprehensive description of the full range of capabilities, refer to the user manual "EUTRA/LTE Digital Standard for R&S SMBV100B".

2.4 System Overview

This section helps you to get familiar with the R&S SMBV100B. It provides an introduction to the general concept of the instrument. This section also introduces the main blocks in the signal generation flow.

For information on how to access functions and interact with the R&S SMBV100B, refer to [Chapter 2.5, "Instrument Control"](#), on page 73.

2.4.1 Brief Introduction to the Instrument's Concept

The R&S SMBV100B offers excellent RF and baseband characteristics. The baseband section of the R&S SMBV100B is fully digital. It contains the hardware for generating and processing I/Q signals in realtime or generating signals with an arbitrary waveform generator.

2.4.2 Signal Flow at a Glance

The R&S SMBV100B is equipped with a large touchscreen, that displays a block diagram. The block diagram represents the signal flow and the general stages the signal generation goes through. Depending on the options the R&S SMBV100B is equipped with, the appearance of the block diagram changes.

The following examples do not cover all possible cases but aim to introduce the way the block diagram depicts the installed options.

- An example of a base unit, equipped with R&S SMBVB-B103.

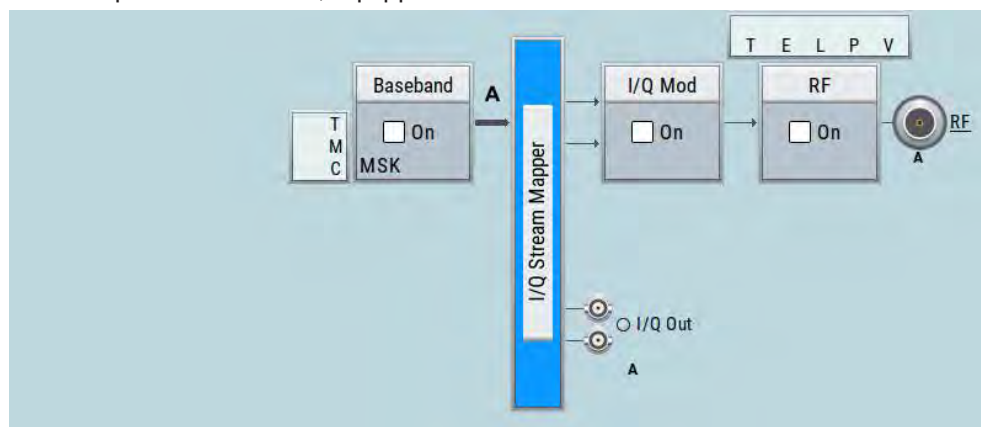

- An example of a fully equipped instrument. The block diagram displays all blocks for that the required hardware and software options are fitted. The block diagram shows the signal flow as it is.

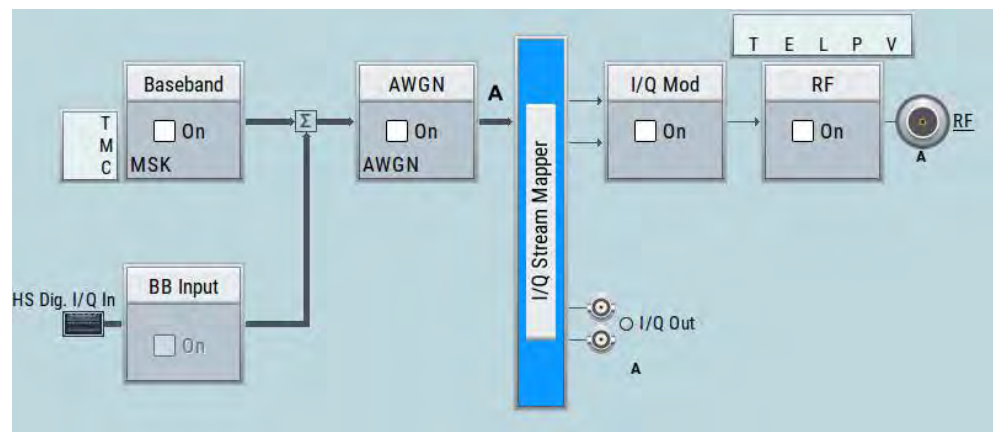

The cross-reference between the installed options and the displayed settings

The Table 2-10 is an excerpt of the available options and lists only the options required to display a functional block in the block diagram. The information assumes R&S SMBV100B base unit.

For exact information on the available options, and on the minimum requirements and the interdependencies between the provided options, refer to the R&S SMBV100B data sheet.

Table 2-10: Required options per functional block (excerpt)

Functional block	Required option
"Baseband"	-
"BB Input"	
"AWGN"	R&S SMBVB-K62
"I/Q Stream Mapper"	-
"I/Q Mod"	-
"I/Q Analog"	-
"RF"	R&S SMBVB-B103/-KB106

2.4.3 Internal Baseband Source ("Baseband" Block)

The "Baseband" block represents the source of the baseband signals (basebands).

This functional block is the access point to:

- *The internal baseband generator*
The baseband generator contains modules for real time signal generation (Custom Digital Modulation) and an arbitrary waveform generator (ARB).
- *The available digital standards*
Generation of digital signals in accordance with the supported standards requires additional software options. For example, option R&S SMBVB-K55 generates signals according to the EUTRA/LTE standard.

- *The baseband offsets function*
Signals from the baseband generator can be shifted in frequency and phase, or boosted in power.

2.4.4 Digital Baseband Input ("BB Input" Block)

The "BB Input" block is the access point to the settings of:

- *The external digital I/Q signals*
The external digital I/Q signals are further processed in the baseband section
- *The baseband offsets function*
The external and internal baseband signals can be shifted in frequency and phase, or boosted in power.

2.4.5 Additional White Gaussian Noise ("AWGN" Block)

The "AWGN" block is displayed only in instruments equipped with the option R&S SMBVB-K62. This block controls the additional white Gaussian noise generator (AWGN). An additive white noise is required for measurements of mobile radio base stations.

2.4.6 "I/Q Stream Mapper" Block

As one of the access points to the system configuration settings, the "I/Q Stream Mapper" provides direct access for mapping the generated I/Q streams to the available output connectors. That is, to the analog RF and I/Q output connectors.

2.4.7 I/Q Modulator ("I/Q Mod" Block)

The "I/Q Mod" block represent the I/Q modulator.

This functional block is the access point to:

- The I/Q modulation of the internal baseband signal
- The I/Q modulation of an external single-ended analog wideband signal
- The analog I/Q impairments

2.4.8 Analog I/Q Output ("I/Q Analog" Block)

The "I/Q Analog" block represents the analog I/Q output connectors.

This block is the access point to the settings of:

- The analog I/Q output signals
The generated signal can be output as single-ended or differential analog signal.
- The analog I/Q impairments

2.4.9 RF and Analog Modulations ("RF" Block)

The "RF" block represents the RF settings of the instrument.

This block is the access point to:

- RF frequency and level settings, as well as the reference frequency, local oscillator, user correction, etc.
- The analog modulations
- The list and sweep modes

2.4.10 Applications Examples of the R&S SMBV100B

The R&S SMBV100B can be optimally adapted to the requirements of different applications:

- Generation of digitally modulated signal
The main field of application of the R&S SMBV100B is the generation of digitally modulated signals. The R&S SMBV100B generates a digitally modulated signal in several ways: using the internal baseband generator, using the externally applied digital baseband signals or in an analog wideband I/Q operation.
- Generation of a wanted signal or an interfering signal for receiver tests
- Generation of signals with up to 500 MHz signal bandwidth

2.5 Instrument Control

This chapter provides an overview on how to work with the R&S SMBV100B.

It covers the following topics:

- [Possible Ways to Operate the Instrument](#).....73
- [Means of Manual Interaction](#).....74
- [Understanding the Display Information](#).....75
- [Accessing the Functionality](#).....79
- [Entering Data](#).....80
- [Getting Information and Help](#).....82
- [Remote Control](#).....83
- [Remote Operation over VNC](#).....84

2.5.1 Possible Ways to Operate the Instrument

There are three ways to operate the R&S SMBV100B:

- Manual operation:
Use the touchscreen, hard keys and rotary knob, or an optional mouse and/or keyboard.
The description under [Chapter 2.5, "Instrument Control"](#), on page 73 shows how to operate the instrument manually.

- Remote control:
Create programs to automatize repeating settings, tests and measurements. The instrument is connected to a computer running the program.
This way of operation is described in [Chapter 11, "Network Operation and Remote Control"](#), on page 520.
- Remote operation from a computer:
Remote monitoring and control of the instrument from a connected computer is based on the common cross-platform technology VNC (Virtual Network Computing). On the remote computer, any standard web browser (supporting Java) or a dedicated VNC client (like Ultr@VNC) can be used. See also [Chapter 2.5.8, "Remote Operation over VNC"](#), on page 84.

2.5.2 Means of Manual Interaction

For the manual interaction with the R&S SMBV100B, you have several methods that you can use as an alternative to perform a task:

- Touchscreen:
Touchscreen operation is the most direct way to interact. Almost all control elements and actions on the screen are based on the standard operating system concept. You can tap any user interface element to set parameters in dialog boxes, enter data, scroll within a dialog etc., as if you work with a mouse pointer.
Tapping the screen works like clicking mouse buttons:
 - Touch quickly = click: Selects a parameter or provokes an action.
 - Touch and hold = right-click: Opens a context-sensitive menu.
 - Touch and swipe = drag: Scrolls through the contents of a display element larger than the screen, e.g. a list or a table.
 - Spread or pinch two fingers = zoom out, zoom in:
Increases or decreases the size of an area in a graphical display as it works on your cell phone
- Function keys and rotary knob:
The front panel provides nearly all functions and controls to operate the instrument in the classic way, without touchscreen.
- Optional mouse and/or keyboard:
These devices work like known from PCs. The navigation keys on the front panel correspond to the keys on the keyboard.

This manual describes the manual interaction with the instrument via the touchscreen. It mentions the alternative methods using the keys on the instrument or the on-screen keypads if it deviates from the standard operating procedures. The usage of the touchscreen and navigation keys is described in [Chapter 2.5.4, "Accessing the Functionality"](#), on page 79.

Throughout the manual, the term "select" refers to any of the described methods, i.e. using a finger on the touchscreen, a mouse pointer in the display, or a key on the instrument or on a keyboard.

2.5.3 Understanding the Display Information

The block diagram of the R&S SMBV100B displays all main settings and generator states, divided into three main operation areas.

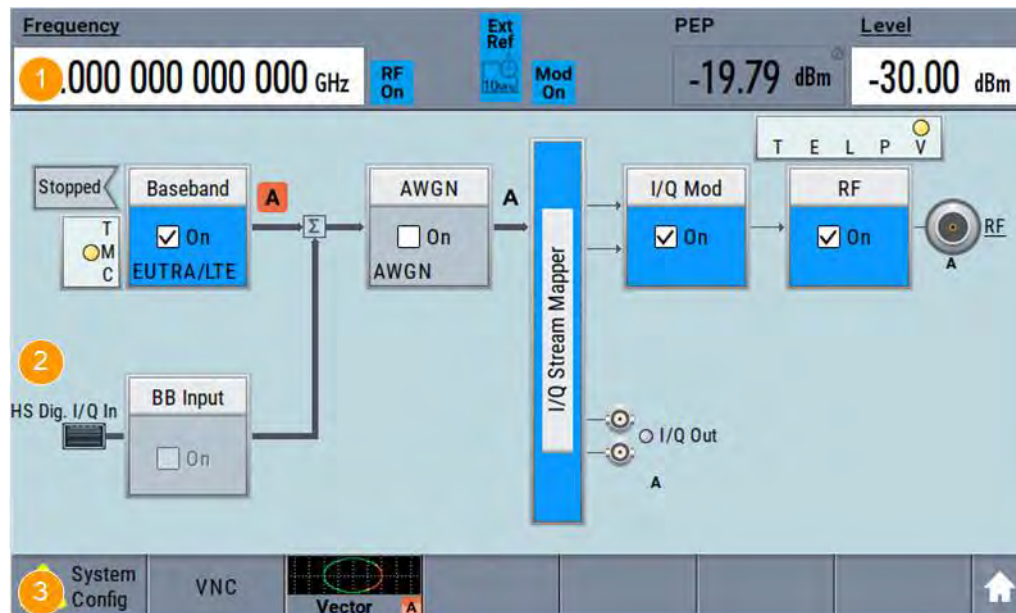

Figure 2-11: Block diagram

- 1 = Status bar (frequency and level display)
- 2 = Block diagram
- 3 = Taskbar/softkey bar

• Status Bar	75
• Block Diagram	76
• Taskbar	77
• Additional Display Characteristics	78

2.5.3.1 Status Bar

The status bar at the top of the screen indicates the RF frequency and the level of the output signal provided to the DUT. You can set both parameters directly here.



- 1 = Frequency display
- 2 = Status buttons
- 3 = Level display

The status buttons indicate key parameters that are set for the output signal. Most of the status buttons are virtual keys you can use to open a corresponding menu or dialog.



Underlined names are touch-sensitive. By touching them, you can execute a setting or access the dialog or menu.

2.5.3.2 Block Diagram

The block diagram shows the current configuration and the signal flow in the generator with the aid of function blocks, connected by signal lines.

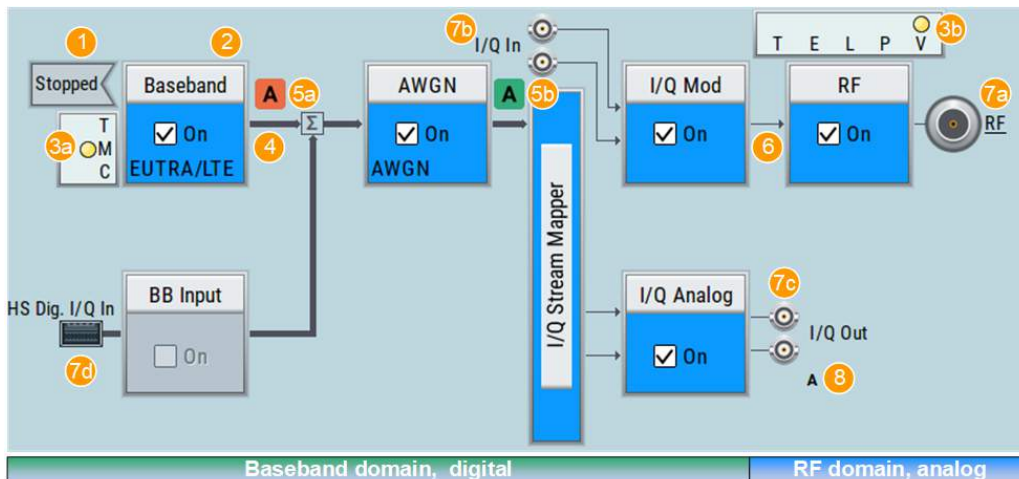

- 1 = Status indicator
- 2 = Functional block
- 3a / 3b = Control signal block
- 4 = Signal line (digital)
- 5a / 5b = Graphics indicator
- 6 = Signal line (analog)
- 7a / 7b / 7c / 7d = Connector icons (RF, analog, digital)
- 8 = Stream indicator

Starting from left up to the "Stream Mapper", you can see the functional blocks provided in the baseband domain. After the stream mapper, the analog section contains the digital to analog conversion and modulation to RF.

Legend	Item	Description
1	Status indicator	Indicates whether the signal is running or waiting for a trigger.
2	Functional block	Represents a basic task in signal generation. The push button provides access to any number of associated actions to accomplish the task. The On/Off (checkbox) and the block label quickly activates the basic task.
3	Control signal block	Indicates information on the control signals like signal content, input or output and provides quick access to the corresponding configuration dialog. A dedicated control block is displayed for each baseband (3a) and RF block (3b).

Legend	Item	Description
4, 6	Signal lines (digital/ analog)	Show the currently configured signal flow. <ul style="list-style-type: none"> Thick lines represent the digital I/Q streams, see (4) in the figure above Thin lines represent the analog signals (6)
5	Graphics indicator	Denotes that the signal is displayed graphically (5a/5b).
7	Connector icons	Represent the interfaces for signal input and output. <ul style="list-style-type: none"> RF signal connector output (7a); (icons vary depending on the frequency) Analog I/Q signal connector input (7b) Analog I/Q signal connector output (7c) Digital I/Q signal connector input (7d) Digital I/Q signal connector output (7e)
8	Stream indicators	Show the input streams at the I/Q stream mapper.

2.5.3.3 Taskbar

The "Taskbar" contains labeled softkeys and minimized views (thumbnails) of active graphics and dialogs.

Initially, it shows the permanently assigned softkeys. The softkey with the sine wave denotes that no signal is activated for graphical representation.



Figure 2-12: Taskbar in default state

Whenever you open a settings or graphics dialog, it is automatically assigned to the "Taskbar". The softkeys shown in the following figure represent the variants.



Figure 2-13: Taskbar fully assigned

- 1 = System configuration
- 2 = Remote control connections
- 3 = Graphics
- 4 = Dialogs
- 5 = Diagram / More

1	System Config	Provides access to general system configurations like setup, display, or remote.
2	Remote	Shows the established remote connections when the instrument is remotely controlled. Tip: An indicator in the status bar shows the current remote control status.
3	Graphics	Shows that a signal is represented graphically.

4	Dialogs	Shows a dialog as a thumbnail, the dialog name, and the name of signal channel.
5	Diagram / More	The diagram icon as shown in Figure 2-12 minimizes all dialogs indicated on the screen. The block diagram is in the foreground. The "More" softkey indicates that more dialogs are open than can be displayed in the taskbar. Use this softkey to open a selection list with the remaining active dialogs, and the "Diagram" function.

2.5.3.4 Additional Display Characteristics

The following section provides a short insight on the indication of the screen in general, and significant elements that you see under specific operating modes, in dialogs or settings.

- **Appearance of active elements**
 - *Active* elements like On/Off switches, state buttons have a **blue** background.
 - *Selected* elements are framed or highlighted **orange**.
 - *Inactive* elements are **gray**.
- **On-Screen keypads**
As additional means of interacting with the instrument without having to connect an external keyboard, either a numerical or alphanumerical on-screen keypad appears when you activate an entry field (see [Chapter 2.5.5, "Entering Data"](#), on page 80).
- **Info line**
The "Info line" shows brief status information and error messages. It appears when an event generates a message.
- **Key parameters indicated in tab labels**
Most dialogs are divided into tabs with logically grouped parameters. The tab label expresses the content and can also contain status indicators or the set value of a key parameter.
- **Scroll bar handle**
An arrow icon that appears when you touch a scroll bar helps you to scroll in a dialog or list.
- **Context-sensitive menus**
Within the entire screen display, including single parameters, you can access context-sensitive menus that provide some additional functions.

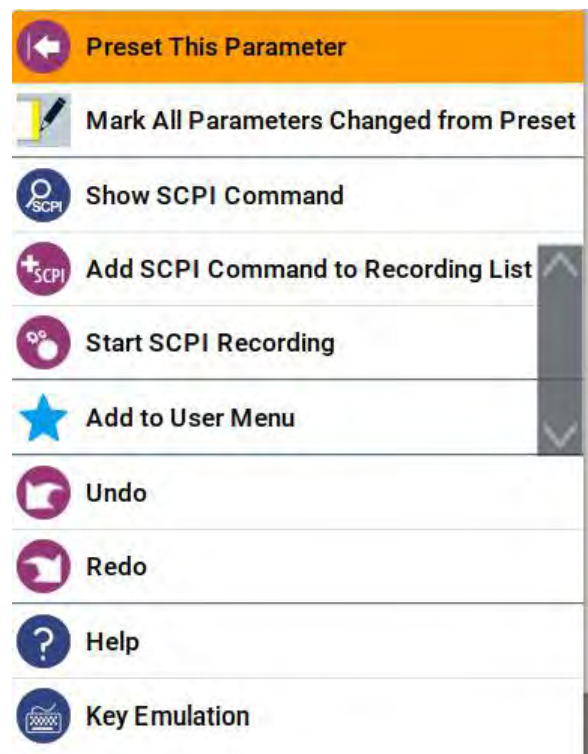

2.5.4 Accessing the Functionality

All functionalities are provided in dialog boxes as known from computer programs. You can control the instrument intuitively with the touchscreen. This section provides an overview of the accessing methods.

The instrument's functions and settings can be accessed by selecting one of the following elements:

- System and function keys on the front panel of the instrument
- Taskbar/softkeys on the touchscreen
- Context-sensitive menus for specific elements on the touchscreen
- Elements on the status bar in the touchscreen
- Displayed setting on the touchscreen, that means block diagram and all settings available in dialogs.

To open a dialog box

- ▶ Perform one of the following actions:
 - Tap the required block, and then the menu entry.
 - Tap the minimized view (thumbnail) on the taskbar.

Some of the utility keys access a dedicated dialog, too.

To minimize a dialog box

- ▶ Tap the "Minimize" icon in the upper right corner.

To close a dialog box

To close a dialog box, you have the same controls as you know from computers or devices with touchscreen.

- ▶ Perform one of the following actions:
 - Tap the "Close" icon in the upper right corner.
 - Press the [Esc] key on the front panel.
 - Drag and drop a minimized dialog from the taskbar to the block diagram.

To select an option in a dialog box

- ▶ Tap the required option.

To select an option in a list

If many options are available - for example, for the trigger mode - the options are provided in a list. The current selection is shown on the list button.

- ▶ Tap in the list, scroll in the list and then tap the required option.
 - Or:
Use the rotary knob
 - Or:
Use [On/Off Toggle] key to select the succeeding option
 - Or:
Use the front panel keys:
 - a) Press the [Left/Right] arrow keys to navigate to the list button.
 - b) Press the [Enter] key to open the list.
 - c) Press the [Up/Down] keys to navigate to the required option in the list.
 - d) Press the [Enter] key to select the marked option.

2.5.5 Entering Data

Some parameters have their own key on the front panel.

For data input in dialog boxes, the instrument provides on-screen keypads for entering numeric and alphanumeric values. Thus, you can always set the parameters via the touchscreen, the front panel, or an external keyboard.

Correcting an entry

1. Using the arrow keys, move the cursor to the right of the entry you want to delete.
2. Press the [Backspace] key.
3. Deletes the entry to the left of the cursor.
4. Enter your correction.

Completing the entry

- ▶ Press the [Enter] key or the rotary knob.

Aborting the entry

- ▶ Press the [Esc] key.
The dialog box closes without changing the settings.

2.5.5.1 Entering Numeric Parameters

To enter values with the on-screen keypad

For numeric settings, the instrument displays the numeric keypad. The units specified correspond to the units of the parameter.

1. Enter the numeric value.
2. Tap the unit button to complete the entry.
The unit is added to the entry.
3. If the parameter does not require a unit, confirm the entered value by pressing "Enter".

To enter values by using the front panel controls

1. Change the currently used parameter value by using the rotary knob or the [Up/Down] keys.
2. If the parameter does not require a unit, confirm the entered value by pressing the [Enter] key or any of the unit keys.
The instrument highlights the editing line to confirm the entry.

If you edit numeric data in tables, the entry field must be in edit mode: Press [Enter], or the rotary knob to activate the edit mode.

2.5.5.2 Entering Alphanumeric Parameters

If a field requires alphanumeric input, you can use the on-screen keyboard to enter letters and (special) characters.

2.5.5.3 Undo and Redo Actions

Accessed via the context-sensitive menus, "Undo" allows you to restore one or more actions on the instrument. Depending on the available memory, the "Undo" steps can restore all actions.



"Redo" restores a previously undone action.

2.5.6 Getting Information and Help

In some dialog boxes, graphics are included to explain the way a setting works.

For further information, you can use the following sources:

- Tooltips give the value range of the parameter.
- The context help provides functional description on a setting.
- The general help explains a dialog box, provides instructions, and general information.

To display context help

- ▶ To access a help topic, perform one of the following:
 - a) Tap and hold the parameter for which you need information and tap "Help" in the context menu.
 - b) Tap the parameter and press the [Help] key.

The "Help" dialog opens. You can browse the help for further information.

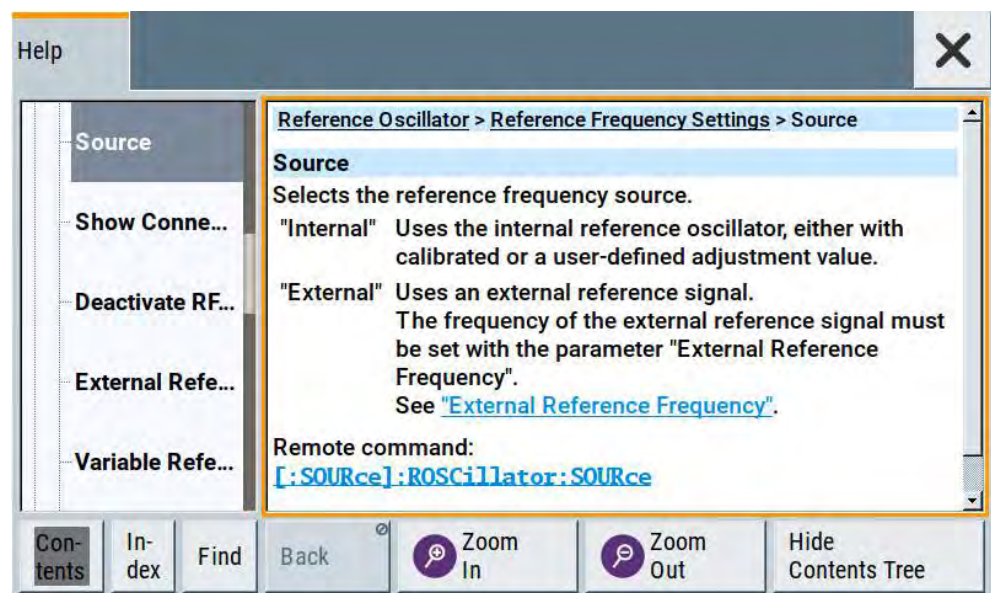

Contents of the help dialog box

The help dialog box covers two main areas:

- "Contents" - contains a table of help contents

- "Topic" - contains a specific help topic

The help system also provides an "Index" and a "Find" area, and "Zoom" functions that are accessed via the corresponding buttons.

To open general help

- ▶ Press the yellow [Help] key on the front panel.

If a dialog box is opened, the help topic for the current tab is shown. Otherwise the "Contents" page appears.

Navigating in the table of contents and in the help topics

1. To move through the displayed contents entries, tap on an entry and scroll or use a connected mouse or the [Up/Down] keys.
Entries with a plus sign contain further entries.
2. To display a help topic, tap on the topic name or double click on the topic name or press the [Enter] key.
3. To follow a cross-reference, tap on the link text.
4. To return to the previous page, select "Back".
This function scrolls back all steps you have performed before.
5. Use the "scroll bars" to shift the visible section of content shown.
6. To maximize the "Topics" area, tap the "Hide Contents Tree" button to hide the contents tree.

Using the index

1. Select the "Index" button.
2. Enter the first characters of the topic you are interested in.
The entries starting with these characters are displayed.
3. Tap on the index entry.
The corresponding help topic is displayed.

2.5.7 Remote Control

In addition to working with the R&S SMBV100B interactively, located directly at the instrument, it is also possible to operate and control it from a remote PC.

The R&S SMBV100B supports various methods for remote control:

- Connecting the instrument to a (LAN) network (see [Chapter 2.1.4, "Setting Up a Network \(LAN\) Connection"](#), on page 37)
- Using the LXI browser interface in a LAN network
- Connecting a PC via the IEC-bus (IEEE 488) interface
- Remote control via the USB interface



For remote control over LAN or USB, you can use the R&S VISA (Virtual Instrument Software Architecture) library provided for download at the Rohde & Schwarz website <http://www.rohde-schwarz.com/rsvisa>.

How to configure the remote control interfaces is described in [Chapter 11, "Network Operation and Remote Control"](#), on page 520.

2.5.8 Remote Operation over VNC

The VNC is an application which can be used to access and control the instrument from a remote computer through a LAN connection. While the instrument is in operation, the instrument screen contents are displayed on the remote computer, and VNC provides access to all applications, files, and network resources of the instrument. Thus, remote operation of the instrument is possible.



Instrument control from a remote computer

To access the basic utility functions of the R&S SMBV100B, perform a right mouse click on the block diagram and select "Key Emulation".

A key panel to the right of the block diagram gives access to the utility functions provided by the front panel keys.

The VNC is an add-on program, included in operating system Linux/Unix, and available as a free-of-charge download on the internet.

For more information, refer to [Chapter 11.16, "How to Set Up Remote Operation via VNC"](#), on page 569.

3 Configuring the Internal Baseband Source

The R&S SMBV100B is a vector signal generator with internal signal generation and real-time functionality and with integrated arbitrary waveform generator.

The instrument enables you to generate various digital modulation signals in accordance with the definitions in the corresponding specifications or with user-definable characteristics. Signals are generated in real-time or played from a data store with external and internal data. The instrument provides an interface for the loading of externally computed modulation signals in form of waveform files.

3.1 Overview of the Signal Generation Modes

The R&S SMBV100B can generate the signal in the following ways:

- [Generating digital modulated signals according to various digital standards](#)
- [Generating a real-time signal](#)
- [Playing a waveform](#)

Generating digital modulated signals according to various digital standards

Provided the instrument is equipped with the required firmware options, the instrument can generate digital standards in accordance with the corresponding specifications.

The required options are specified in the description of the respective digital standard (see the corresponding user manual).

See also [Chapter 3.3, "Generating Signals According to Digital Standards"](#), on page 87.

Generating a real-time signal

- While utilizing the *internal* signal generator, the R&S SMBV100B generates the digital modulation signals with user-definable characteristics in real time. See also [Chapter 3.5, "Generating Custom Digital Modulated Signals"](#), on page 116.
- If the required options are installed, *externally supplied real-time* baseband signals can be added to the internally generated signals. See also [Chapter 8.6, "Digital Baseband Input Settings"](#), on page 426.

Playing a waveform

The R&S SMBV100B is equipped with an Arbitrary Waveform Generator (ARB) used to generate test signals and to process waveform files. Waveforms are files with settings provided for repeatable tests with the same test signal. Irrespectively of the way these waveform files are generated, they are always played from the instrument. That is, the signal calculation is performed in advance and the instrument reacts as a player.

- *Externally* computed waveform files can be loaded in the instrument over the LAN, USB, or the GPIB interface.

Waveforms can be generated for example with the signal generation software R&S WinIQSIM2 or the R&S®Pulse Sequencer software.

- The instrument provides different functions to generate waveforms *Internally*.
 - Some of the digital standards firmware options provide the possibility to store the current signal settings into a waveform file. These waveform files can be loaded in and processed as multi-carrier or multi-segment signal by the ARB generator.
See also [Chapter 3.6, "Using the Arbitrary Waveform Generator \(ARB\)"](#), on page 145.
 - Multi-carrier waveforms consisting of carriers modulated by different baseband signals can be configured and created internally. Such multi-carrier waveform files are required to simulate complex multi-carrier scenarios with different baseband signals, e.g. CDMA2000, 3GPP FDD, or signals in accordance with the LTE-Advanced specifications.
See also [Chapter 3.8, "Generating Multi-Carrier Signals"](#), on page 197.
 - Provided the instrument is equipped with the corresponding option, it is also possible to generate multi-carrier waveforms consisting of unmodulated carriers
See also [Chapter 3.9, "Generating Multi-Carrier Continuous Wave Signal"](#), on page 215.

3.2 How to Access the Functions in the Baseband Domain



To access the functions of the baseband generator

1. In the block diagram, select the "Baseband" block and navigate through the context menu.

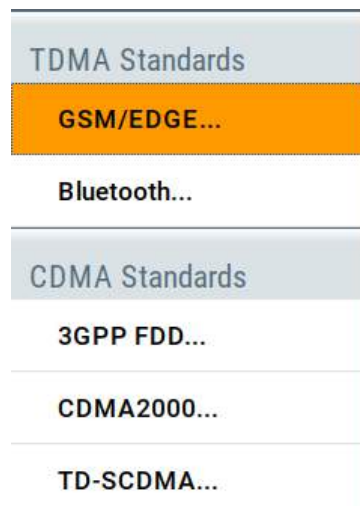

The "Baseband" block comprises all functions and settings concerning the baseband signal. These include all generation modes, as described in the [Chapter 3.1, "Overview of the Signal Generation Modes"](#), on page 85.

2. The signal generation is not started immediately.

To activate the baseband generator: in the block diagram, select the "Baseband" block and set "Baseband > On".

Note: The internal baseband generator ("Baseband" block) and the external digital baseband input ("BB Input") cannot be activated simultaneously. They deactivate each other.

A short designation indicates the digital standard or modulation currently selected.

For information, see:

- [Chapter 3.5, "Generating Custom Digital Modulated Signals"](#), on page 116
- [Chapter 3.6, "Using the Arbitrary Waveform Generator \(ARB\)"](#), on page 145
- [Chapter 3.9, "Generating Multi-Carrier Continuous Wave Signal"](#), on page 215
- The description of the digital standards
- [Chapter 3.10, "Shifting and Boosting the Baseband Signal"](#), on page 224

3.3 Generating Signals According to Digital Standards

The R&S SMBV100B generates digital signals in accordance with the specifications of the main communication and radio standards only if the corresponding firmware options are installed.

GSM/EDGE, EDGE Evolution

This digital standard requires an instrument equipped with the GSM/EDGE and EDGE Evolution options R&S SMBVB-K40/-K41.

The GSM/EDGE, EDGE Evolution options provide functionality to generate signals in accordance with the GSM/EDGE standard, based on the GMSK and 8PSK modulation, and in accordance with the EDGE Evolution standard with simulation of higher order modulations.

For details, see the R&S SMBV100B GSM/EDGE user manual.

Bluetooth® Enhanced Data Rate/Low Energy

This digital standard requires an instrument equipped with the options Bluetooth® Enhanced Data Rate and Bluetooth® 5.0 R&S SMBVB-K60/-K117.

The Bluetooth® options provides functionality to generate signals in accordance with the Bluetooth Specification 5.0+EDR and the latest Bluetooth Low Energy specification.

For details, see the R&S SMBV100B Bluetooth EDR user manual.

3GPP FDD incl. enhanced MS/BS tests, HSPA, HSPA+

This digital standard requires an instrument equipped with the 3GPP FDD incl. enhanced MS/BS tests, HSPA, HSPA+ options R&S SMBVB-K42/-K83.

These options provide functionality to generate signals in accordance with the WCDMA standard 3GPP FDD.

For details, see the R&S SMBV100B 3GPP FDD user manual.

CDMA2000®

This digital standard requires an instrument equipped with the CDMA2000 option R&S SMBVB-K46.

The CDMA2000 option provides functionality to generate signals in accordance with the CDMA2000 standard 3GPP2 C.S0002-C, version 1.0 (release C).

For details, see the R&S SMBV100B CDMA2000 user manual.

TD-SCDMA and TD-SCDMA enhanced features

This digital standard requires an instrument equipped with the TD-SCDMA and TD-SCDMA enhanced features options R&S SMBVB-K50/-K51.

The TD-SCDMA options provide functionality to generate signals in accordance with the TD-SCDMA (3GPP TDD LCR) standard.

For details, see the R&S SMBV100B TD-SCDMA user manual.

1xEV-DO Rev. A and Rev. B

This digital standard requires an instrument equipped with the 1xEV-DO Rev. A and Rev. B options R&S SMBVB-K47/-K87.

The 1xEV-DO options provide functionality to generate signals in accordance with the CDMA2000 1xEV-DO (Evolution-Data Optimized), Rev. A and Rev. B standard.

For details, see the R&S SMBV100B 1xEV-DO Rev. A Rev. B user manual.

IEEE 802.11a/b/g/n, IEEE 802.11ac, IEEE 802.11ax

This digital standard requires an instrument equipped with the IEEE 802.11a/b/g/n and IEEE 802.11ac and IEEE 802.11ax options R&S SMBVB-K54/-K86/-K142.

These options provide functionality to generate signals in accordance with the Wireless LAN standards IEEE 802.11a/b/g/n/ac/p/j/ax.

For details, see the R&S SMBV100B IEEE 802.11a/b/g/n/p/j/ac/ax user manual.

EUTRA/LTE Rel. 8, Rel. 9, Rel. 10, Rel. 11, Rel. 12, Rel. 13/14, Cellular IoT

This digital standard requires an instrument equipped with the EUTRA/LTE options R&S SMBVB-K55/-K69/-K81/-K84/-K85/-K112/-K113/-K115/-K119.

These options provide functionality to generate signals in accordance with the 3GPP standard EUTRA/LTE Rel. 8, Rel. 9, Rel. 10, Rel. 11, Rel. 12 and Rel. 13/14.

For details, see the R&S SMBV100B EUTRA/LTE user manual.

5G New Radio

This functionality requires an instrument equipped with the 5G New Radio option R&S SMBVB-K144.

This option provides functionality to generate signals in accordance with the 3GPP standard New Radio Rel. 15.

For details, see the R&S SMBV100B 5G New Radio user manual.

OFDM Signal Generation

This functionality requires an instrument equipped with the OFDM signal generation option R&S SMBVB-K114.

This option provides functionality to generate OFDM signals and signals according to predefined OFDM modulation schemes.

For details, see the R&S SMBV100B OFDM Signal Generation user manual.

3.4 Common Functions and Settings in the Baseband Domain

Basic signal generation settings that are common to many generation tasks, regardless of the selected baseband source or digital standard, are described here. If you are performing a specific signal generation task, like generating a signal according to a digital standard, be sure to check the specific description for settings that may deviate from these common settings.

3.4.1 Basics on Signals, Modulation Types and Filters Used the Baseband Domain

This section provides general information on common topics and basic principles.

- [Data, Clock and Control Signals and Sources in the Baseband](#)..... 89
- [Regular Marker Output Signals](#).....94
- [Baseband Trigger Signals](#).....96
- [Supported Modulation Types](#)..... 103
- [Supported Coding Schemes](#)..... 104
- [Supported Baseband Filters](#).....105
- [Methods for Optimizing the Crest Factor](#)..... 107

3.4.1.1 Data, Clock and Control Signals and Sources in the Baseband

This section describes the common characteristics of the signals used for generating the baseband signal for all standards. Common characteristics do not depend on the used generating mode (see [Chapter 3.1, "Overview of the Signal Generation Modes"](#),

on page 85). The selection in the dialogs at any given time depends on the parameter and standard concerned. It is clear from the selection list offered in the dialog. Some parameters are therefore not available in certain cases.

Characteristics which are uniquely specific to particular standards are described in the corresponding user manual.

For the generation of modulation signals, the instrument uses the following input signals:

- [Internal Modulation Data](#)
- ["Clock Signals"](#) on page 91
- [Control Signals](#)

Signal sources

The data, the clock and the trigger signals can be both internally generated and supplied from an external source. Control signals however are always generated internally.

Depending on the current configuration, the internally generated data and marker signals are output on one or several connectors. The output capabilities of the instrument and the required connectors are configurable.

See [Chapter 10.2, "Configuring the Global Connectors"](#), on page 486.

Internal Modulation Data

The R&S SMBV100B uses the following internal modulation data sources:

- **Data lists**

Data lists are externally or internally created binary lists with modulation data. The instrument provides standard file select function for loading of existing data lists, creating internally new data lists or editing an existing one. Internally, data lists are created in the dedicated "Data List" editor (see [Chapter 3.5.3.7, "Data List Editor"](#), on page 128). A separate file is created for each list and stored on the instrument's hard disk. The filename is user-defined; the file extension is `*.dm_iqd`.

The maximum length of a data list is determined by the size of the data list memory (see data sheet). There is no restriction on the number of lists that can be stored. Settings for file handling, like transferring external data lists to the instrument, or renaming of folders and files, are accessed via the standard "File Manger" function. (See also [Chapter 9, "File and Data Management"](#), on page 442).

- **Data patterns**

Simple data patterns such as binary 0 ("All 0") strings or 1 ("All 1") strings or variable bit strings with a maximum length of 64 bits can be used as internal modulation data.

- **PRBS data**

The PRBS generators deliver pseudo-random binary sequences of differing length and duration. They are known as maximum length sequences. PRBS sequences are generated with the aid of ring shift registers with feedback points determined by the polynomial.

The pseudo-random sequence from a PRBS generator is uniquely defined by the register number and the feedback. The [Table 3-1](#) describes the available PRBS generators.

For PRBS15 and PRBS23, a CCITT V.52-compliant data inversion is performed in the feedback path automatically.

Table 3-1: Overview of PRBS generators

PRBS generator	Length in bits	Feedback to	GUI selection
9-bit	$2^9 - 1 = 511$	Registers 4, 0	PRBS 9/PN9
11-bit	$2^{11} - 1 = 2047$	Registers 2, 0	PRBS 11/PN11
15-bit	$2^{15} - 1 = 32767$	Registers 1, 0	PRBS 15/PN15
16-bit	$2^{16} - 1 = 65535$	Registers 5, 3, 2, 0	PRBS 16/PN16
20-bit	$2^{20} - 1 = 1048575$	Registers 3, 0	PRBS 20/PN20
21-bit	$2^{21} - 1 = 2097151$	Registers 2, 0	PRBS 21/PN21
23-bit	$2^{23} - 1 = 8388607$	Registers 5, 0	PRBS 23/PN23

Example:

By way of example, the diagram on [A 9-bit PRBS generator](#) shows a 9-bit generator with feedback to registers 4 and 0 (output). The generated serial data is converted internally, e.g. 2 Bit/Symbol if QPSK is used.

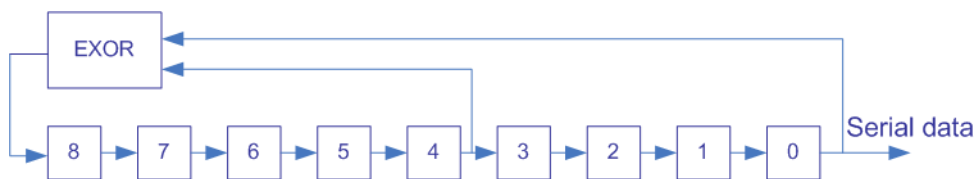

Figure 3-1: A 9-bit PRBS generator

Related settings:

- [Chapter 3.5.3.3, "Data Source"](#), on page 119
- [Chapter 3.5.3.7, "Data List Editor"](#), on page 128
- [Chapter 3.5.3.8, "Control and Marker Lists Editor"](#), on page 130
- "Data Source" selection in the dialogs of the firmware options

Clock Signals

The instrument requires a clock reference for generating the timing pulse and uses its internal clock reference for that purpose.

The internally generated symbol clock signal can be output at the User x connectors. The [Table 3-2](#) gives an overview.

Table 3-2: Output connectors for the reference clock signal

Connector	Location	GUI selection
User x	Front and rear panel	To configure the connector: <ul style="list-style-type: none"> • "Custom. Dig. Mod/Digital Standard > Clock Settings > Global Connectors > Direction > Output" • "Custom. Dig. Mod/Digital Standard > Clock Settings > Global Connectors > Signal > Symbol Clock" To enable the clock source <ul style="list-style-type: none"> • "Custom. Dig. Mod/Digital Standard > Clock Settings > Clock Source > Internal"

Synchronizing data signals and clock signals

The synchronization is always based on the positive edge of the clock.

Related settings:

- [Chapter 3.4.2.3, "Clock Settings"](#), on page 115
- [Chapter 10.2, "Configuring the Global Connectors"](#), on page 486
- Clock settings in the dialogs of the firmware options

Control Signals

The following control signals are processed in the R&S SMBV100B:

- "Burst Gate" for power ramping
- "Level Attenuation" for power ramping
- "CW/Mod" for controlling the CW (continuous wave) mode

A dedicated internal "Control Data Editor" is provided for defining the control signals. Refer to [Chapter 3.5.3.8, "Control and Marker Lists Editor"](#), on page 130 for a description on the provided settings.

Continuous Wave Mode

The "CW" signal turns off digital modulation. The signal is output in unmodulated form.

The CW/Mod control signal is generated internally and is output at one of the User x connectors.

Power Ramping and Level Attenuation

The R&S SMBV100B uses the two control signals "Burst Gate" and "Lev_Att" to trigger the power ramping and level attenuation functions.

The instrument internally generates control signals as configured in [Chapter 3.5.3.8, "Control and Marker Lists Editor"](#), on page 130; the signals can be output on the User x connectors.

- *Burst gate control signal*
The "Burst Gate" signal is a rectangular pulse signal with variable low and high periods. Signal generation is restricted to the gate high periods. If the power ramping function is enabled, each transition between two gate periods of the "Burst Gate" signal triggers the generation of a ramp. Further settings define the form and

the steepness of this ramp, see ["Impact of the Power Ramping Settings on the Generated Signal"](#) on page 93.

- *Level attenuation control signal*
The "Lev_Att" signal is a rectangular pulse signal with variable low and high periods. Level attenuation is applied, if the "Lev_Att" signal is high. If level attenuation is enabled, the modulation signal level is attenuated by a defined value.

Related settings:

- [Chapter 3.5.3.6, "Power Ramp Control Settings"](#), on page 126



Possible applications

- Use the "Level Attenuation" function to simulate radio stations located at various distances.
- Use the "Power Ramp" function if it is necessary to control the RF output signal envelope synchronously, e.g. by the generation of TDMA signals.

Both the GSM/EDGE and the TD-SCDMA firmware options are equipped with embedded power ramping function. In the GSM/EDGE standard for example, a maximum of 7 different level attenuation values can be defined and allocated separately to the 8 slots independently of one another.

Impact of the Power Ramping Settings on the Generated Signal

The [Figure 3-2](#) explains the power ramping function in principle. The "Burst Gate" signal defines the start of the rising and falling edges of the envelope of the output signal, and the "Lev Att" signal defines the start and end of level attenuation. The signal level during the attenuation period is a configurable value.

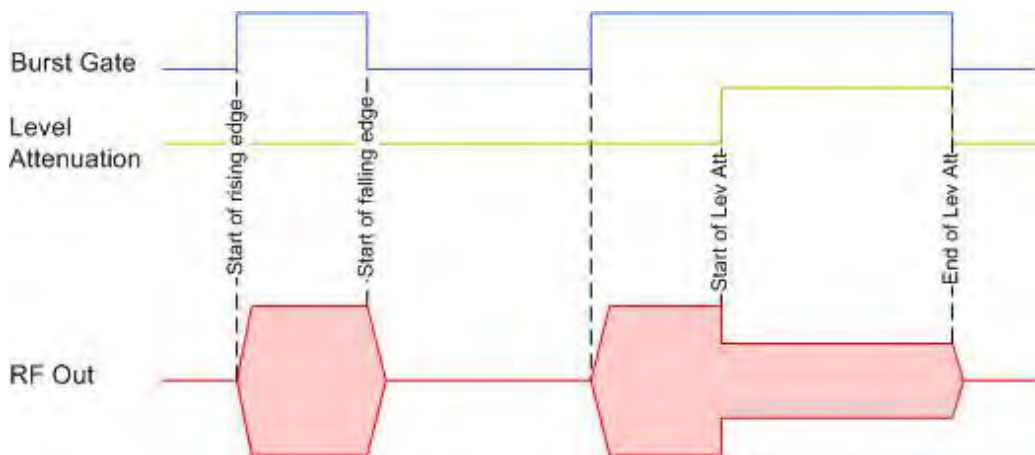

Figure 3-2: Signal behavior when power ramping and level attenuation are enabled

Several parameters are provided for precise definition of the form and the steepness of ramp. The [Figure 3-3](#) depicts the impact of the provided settings.

- Ramp function: defines the shape of the rising and falling edges
- Ramp time: defines the duration of the rising and the falling ramp

- Rise/fall delay: offsets the falling edge of the envelope at the beginning/end of a burst

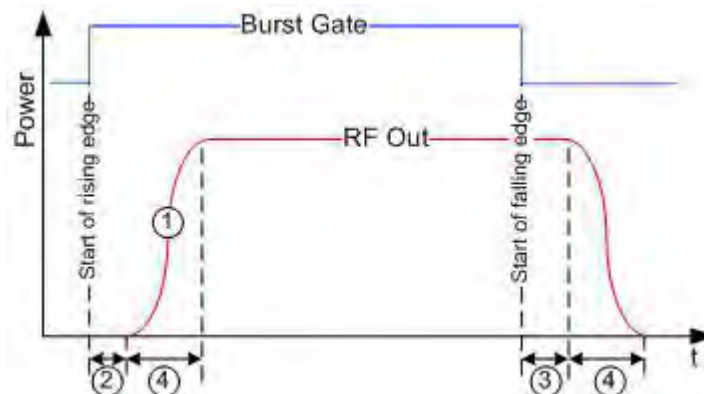

Figure 3-3: Impact of the ramp settings

- 1 = "Ramp Function"
- 2, 3 = "Rise Delay", "Fall Delay"
- 4 = "Ramp Time"

3.4.1.2 Regular Marker Output Signals

The R&S SMBV100B can add *additional signals* to the generated signal. Marker signals (or markers) are digital signals which can be used to synchronize external devices to the generated data stream. For example, with suitable marker settings, a slot clock or frame clock can be selected, or the start of a particular modulation symbol can be marked.

Three marker output signals are available; they can be output at the User x connectors.

Related settings:

- [Chapter 3.4.2.2, "Marker Settings"](#), on page 113
- [Chapter 10.2, "Configuring the Global Connectors"](#), on page 486
- Marker settings in the dialogs of the firmware options

Marker Modes

The marker mode is a characteristic for the shape and the periodicity of the marker. The R&S SMBV100B provides several different modes to define different marker signals. Most of them are specific for each of the firmware options. This section focuses only on the general commonly available marker signals.

Generally, the marker signal can change from "On" (high) to "Off" (low) state or vice versa after some period of time. The instrument provides various ways to describe the marker signal. Use the method that best suits your needs.

Marker mode restart

The generated marker signal is a single "On" pulse. The rising edge of this pulse is generated at the signal generation start as well as at each subsequent signal restart

time. This marker can be used to monitor the effects of the selected trigger, e.g. trigger causing restarts of the signal generation.

Marker mode pulse

Periodic marker with consecutive On and Off periods of equal length. The first On period starts at the beginning of the first generated sample/symbol. The marker frequency is defined by a "Divider". The frequency is derived as follows:

<Frequency> = "Symbol/Sample Rate" / "Divider", respectively

<Frequency> = "Sampling Frequency" / "Divider".

Example:

"Symbol Rate = 1 Msym/s", "Divider = 2"

The marker frequency is 500 kHz, corresponding to a marker period of 2 us. Each On and Off period has a length of 1 us, corresponding to one symbol period. With a divider of 4 (6, 8 ...), the length of each On and Off period is increased to 2 (3, 4, ...) symbol periods.

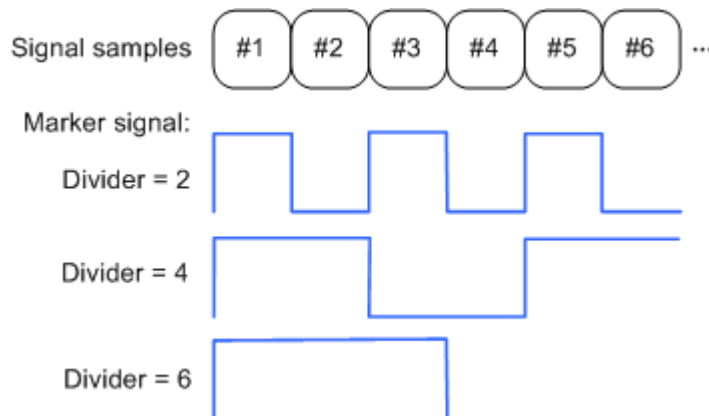

Marker mode pattern

Periodic marker where each period is defined by a bit pattern with a maximum length of 64 bits. A "1" ("0") in the pattern denotes an On (Off) signal segment with a duration of one sample/symbol period.

Example:

In the following example, the marker signal is defined by a pattern 100100....

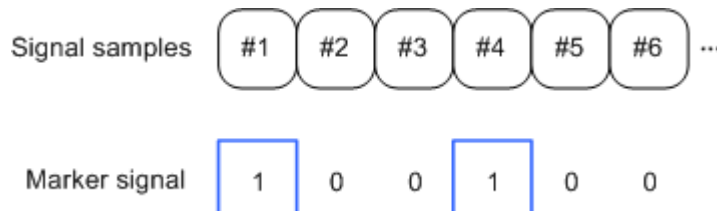

Marker mode ON/OFF ratio

Similar to "Pulse" but with independent lengths of the On and Off periods. The length of the periods is entered as a number of symbols/sample periods.

Example:

In the following example, the marker signal is defined by an "On Time" = 1 and "Off Time" = 2.

**Marker mode CList**

This is not one of the most common modes.

The instrument generates a marker signal that is defined in the selected control list. The R&S SMBV100B provides a graphical interface for convenient definition of control signals among others also for the marker signals.

Delaying Marker Signals

In all the examples listed in "[Marker Modes](#)" on page 94, the marker starts at the beginning of the first generated sample/symbol (sample/symbol no. 1). It is possible though to delay the start of the marker by an integer number of symbols/sample periods.

3.4.1.3 Baseband Trigger Signals

The R&S SMBV100B provides several trigger modes, different trigger sources, and some additional trigger settings to suppress or delay the trigger events. This section provides an overview of the provided baseband trigger settings and the impact of the trigger settings on the signal generation.

The current signal generation status ("Running" or "Stopped") is continuously displayed in the corresponding dialog, indicated in the header of the tab and in the block diagram of the instrument. This indication is important when an external trigger is applied.

For information on the trigger signals used in the RF domain, see [Chapter 6.10.1, "Signal Generation and Triggering in the Sweep and List Modes"](#), on page 286.

Trigger

The trigger signals are internally generated or externally supplied signals which start signal generation at a particular point in time. However, signal generation can also take place without triggering. In this case, the signal generation starts immediately after the modulation is enabled.

Trigger event

A trigger event is caused by the received trigger signal. Another possibility to provoke a trigger event is to execute trigger manually. The "Arm" function stops the signal generation until subsequent trigger event occurs.

- [Trigger Sources](#).....97
- [Impact of the Trigger Modes on the Signal Generation](#)..... 97
- [Impact of the Additional Trigger Settings](#)..... 100
- [Receiving and Providing Trigger Signals](#)..... 103

Trigger Sources

The provided trigger sources are divided into two main groups, internally generated or externally supplied trigger signals.

- Internal ("Internal")
Internal trigger signals are generated by the instrument itself.
- External ("External Global Trigger")
External trigger signal is generated by an external trigger source.
The instrument expects the trigger signal at one of the User x connectors. Refer to [Configuring the Global Connectors](#) for information on how to configure the required settings.
- External ("Baseband Sync In")
In **master-slave** mode, slave instruments are triggered by the active edge of the synchronization signal.
This trigger source is selected automatically and cannot be changed.
See [Chapter 8.3.1, "Connecting Multiple Instruments in Master-Slave Mode"](#), on page 399.



The trigger mode setting, the selection of the trigger source and the setting of a delay and trigger suppression in the case of external triggering are carried out independently. However, the polarity and impedance characteristics of the external signals are identical for all basebands using this signal.

A signal which marks the trigger event can be output at the User x connectors.

Related settings:

- [Chapter 3.4.2.1, "Trigger Settings"](#), on page 110
- [Chapter 10.2.5, "Global Connectors Settings"](#), on page 491
- Trigger settings in the dialogs of the firmware options

Impact of the Trigger Modes on the Signal Generation

A trigger event affects the signal generation in different way, depending on the selected trigger mode. The [Table 3-3](#) gives an overview of the provided trigger modes and their impact.

Table 3-3: Impact of the trigger events on the generated signal

"Trigger Mode"	Signal generation mode ¹	Trigger event "Exec. Trigger" or "External" trigger signal	Trigger event "Arm"
"Auto"	Continuous	-	-
"Retrigger"	Continuous	Initial start Restart	-
"Armed_auto"	Continuous	Initial start Restart	Stop
"Armed_retrigger"	Continuous	Initial start Restart	Stop
"Single"	Single length determined by "Trigger Signal Duration"	Initial start Restart	-

¹⁾ The instrument generates a continuous signal or a single signal.

- Single signal generation means that the signal generation stops after one cycle. That is, after the signal with signal length determined by the "Trigger Signal Duration" has been generated.
- Continuous transmission means that the signal is generated repeatedly without delay and until the data generation is stopped explicitly. However, any parameter change within the processing chain (baseband, fading simulator, or stream mapping) causes a signal generation restart.

The following is a list of the trigger modes together with their short description. An example of their impact on the generated signal is given. The provided examples are intended to show the triggering mechanism in principle. To simplify the description, an internal trigger event ("Execute Trigger") is used. An external trigger event has the same effect on the signal generation. In the examples on the figures below, the instrument's processing time is ignored.

- Single
The instrument starts the signal generation only when a trigger event occurs. The signal is generated once. Its signal length is set with the parameter "Trigger Signal Duration".
Every subsequent trigger event causes a restart.

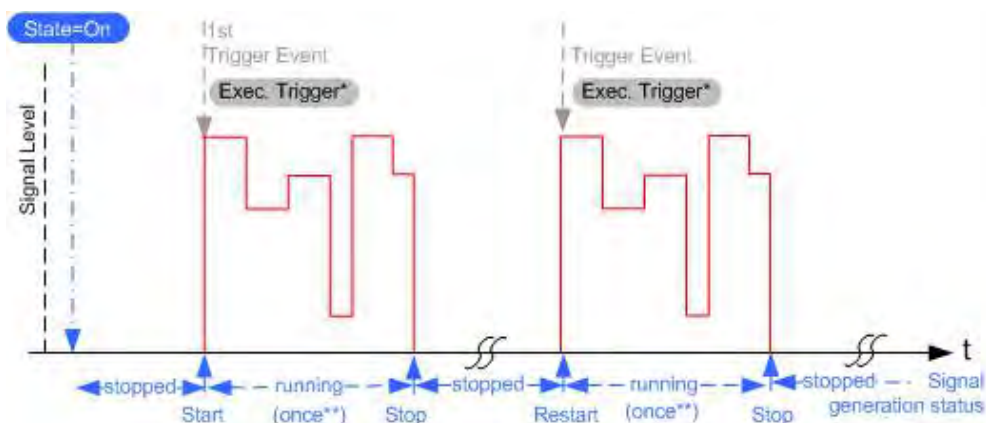

Figure 3-4: Trigger mode single

** = the signal is generated once to the length specified with "Trigger Signal Duration"

- Auto
In auto trigger mode, the instrument generates a continuous signal.

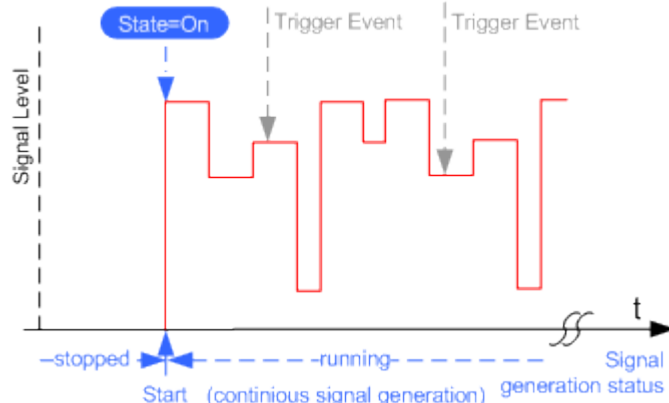

Figure 3-5: Trigger mode auto

- Retrigger
The instrument generates a continuous signal. With enabled retrigger, a new trigger event aborts the current generation cycle and restarts the signal generation from the beginning.

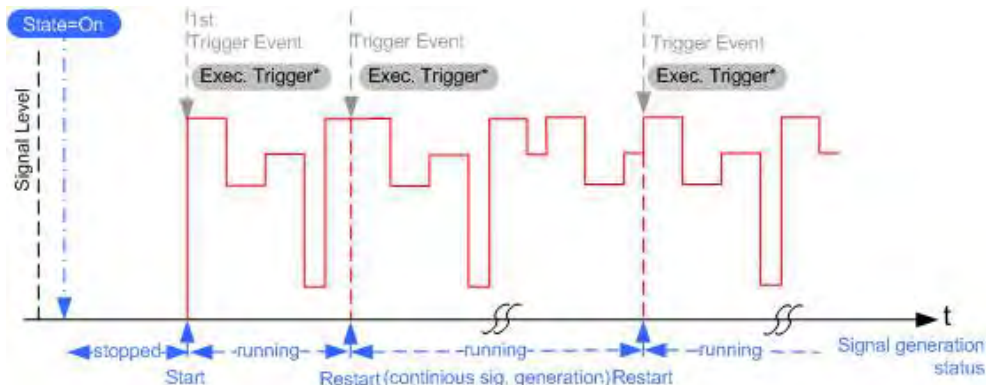

Figure 3-6: Trigger mode retrigger

Compare the shape and the length of the red curve in single mode and in retrigger mode. The first part of the curve in retrigger mode is shorter. The signal generation is interrupted due to the subsequent trigger event.

- Armed auto

The instrument starts the signal generation only when a trigger event occurs and then generates a continuous signal. An "Arm" stops signal generation. A subsequent trigger event causes a restart of the signal generation.

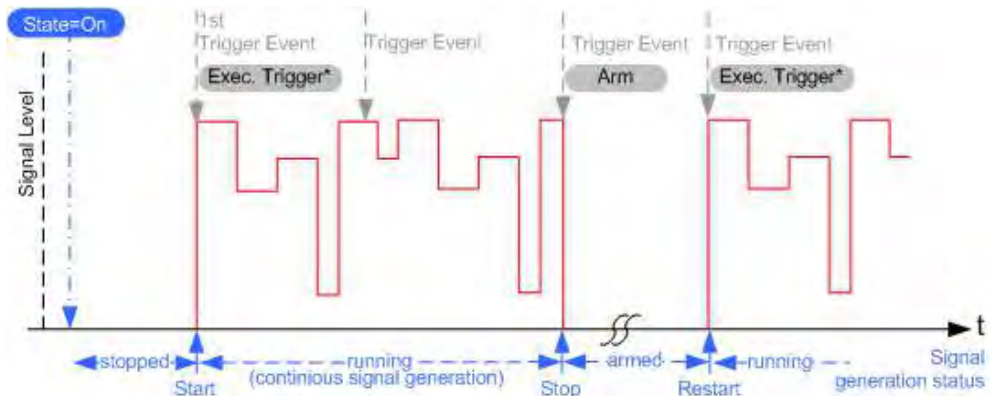

Figure 3-7: Trigger mode armed auto

- Armed retrigger

The instrument starts the signal generation only when a trigger event occurs and then generates a continuous signal. Every subsequent trigger event causes a restart of the signal generation.

An "Arm" stops the signal generation. A subsequent trigger event causes a restart.

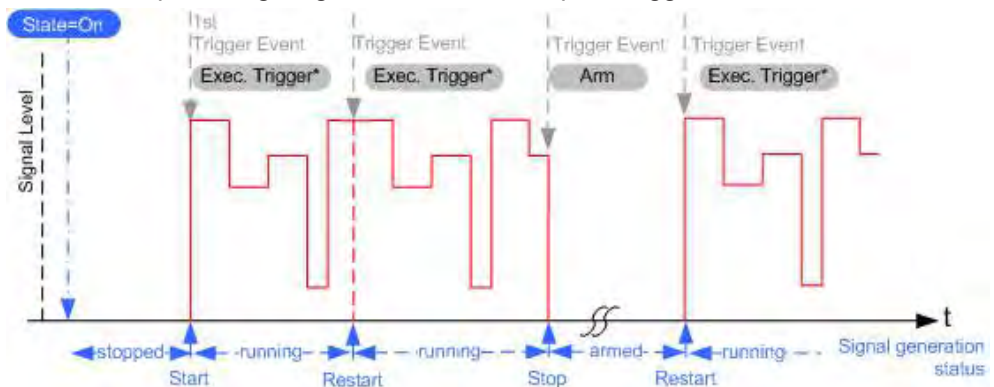

Figure 3-8: Trigger mode armed retrigger

Impact of the Additional Trigger Settings

The R&S SMBV100B provides a set of settings to configure the behavior upon receiving of a trigger signal. For example:

- Suppressing trigger events
- Delaying the instrument's response on trigger events
- Adjusting the signal calculation start time in relation to the trigger event.

Avoiding accidental trigger events

The following trigger settings enhance the flexibility of the trigger system and can help to avoid accidental trigger events.

- "Threshold Trigger Input"
Defines the voltage level of the trigger signal where the R&S SMBV100B generates a trigger event. Trigger signals below the trigger threshold are ignored.
- "Trigger Input Slope"
Specifies the edge (rising or falling edge) of the trigger signal that is to provide the trigger event.
- "Impedance Trigger Input"
Specifies the input impedance of the trigger signal.

Starting the signal generation with the first sample

By default, the instrument starts the signal calculation simultaneously with the receiving of the external trigger event. Because of the signal propagation time and the instrument's processing time, the first samples are cut off and no signal is output.

This default behavior, however, can cause problems if short signal sequences are generated. To overcome this problem, the instrument provides the special parameter "Sync. Output to (External) Trigger". If this parameter is disabled, the signal output begins after elapsing of the processing time and starts with sample 0. That is, the complete signal is output (compare both figures in [Table 3-4](#)).

Table 3-4: Impact of the parameter Sync. Output to (External) Trigger

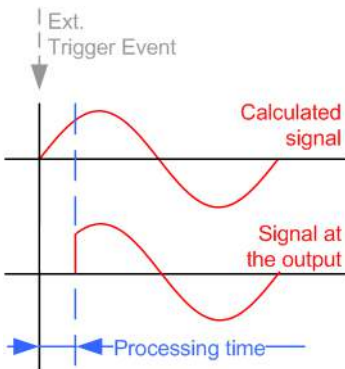
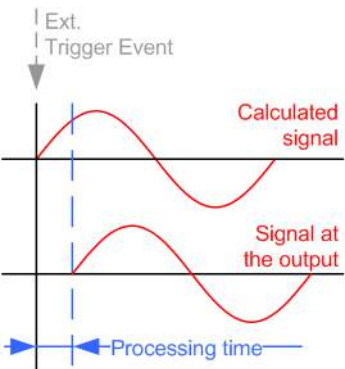
"Sync. Output to (External) Trigger = On"	"Sync. Output to (External) Trigger = Off"
 <p>Suitable for long signal sequences The output signal is synchronous to the trigger event after elapsing of the internal processing time. In master-slave mode, this setting ensures that once achieved, synchronization is not lost if the baseband signal sampling rate changes. See also Chapter 8.3.1.2, "How to Connect and Configure Instruments in Master-Slave Mode", on page 401</p>	 <p>Suitable for triggering of short signal sequences with signal duration comparable with the processing time of the instrument</p>

Suppressing and delaying trigger events

The main focus of the following features is the mobile communication standards.

- "(External) Trigger Delay"
You can apply a definable number of symbols to delay the **start** trigger event of an externally supplied trigger signals
This feature is useful to:
 - Simulate the time delay between a base station signal and a user equipment signal, for example during base station tests
 - Compensate for known propagation delays or a timing offset in the test setups
- "(External) Trigger Inhibit"
You can suppress the effect of a restarted trigger signal in the "Retrigger" trigger mode for a definable number of symbols.
During base station tests for example, this feature enables the trigger suppression for a definable number of frames and yet the signal can still be generated synchronously. In each frame, the base station generates a trigger which would cause a signal generation restart every time but for the suppression.

Example:

A trigger delay of 1000 samples means that after a trigger event, any subsequent trigger signal is ignored for the space of 1000 samples.

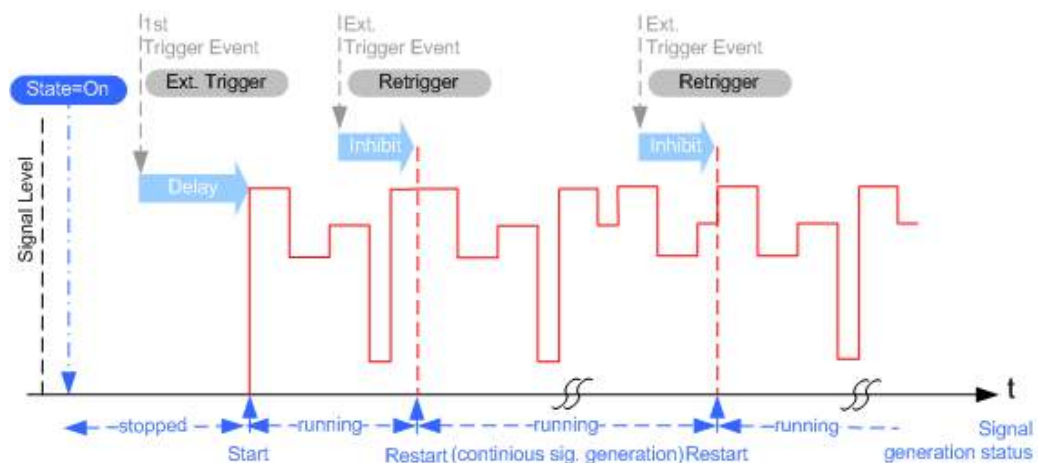

Figure 3-9: Trigger delay and trigger inhibit in trigger mode retrigger

Specifying delay and inhibit values in time units

The [Suppressing and delaying trigger events](#) introduces the concept of delaying and suppressing trigger events.

The delay and inhibit values are expressed in the units of the generated signal but you can also define the exact delay or inhibit period directly as a time value (e.g. in seconds).

Example:

This example is based on an ARB signal with 1 MHz clock frequency ("Baseband > ARB > Clock Frequency = 1 MHz").

Step 1: Enable the following settings:

- "ARB > Trigger In > Mode > Armed Auto"
- "ARB > Trigger In > Source > External Global Trigger 1"
- "ARB > Trigger In > External Delay Unit > Samples"
- "ARB > Trigger In > External Delay = 100 Samples"

The parameter "Actual External Delay = 100 us" displays the time delay in seconds.



Step 2: Enable the following settings:

- "ARB > Trigger In > External Delay Unit > Time"
- "ARB > Trigger In > Specified External Delay = 10 us"
Logically, the "Actual External Delay" changes to 10 us.

Step 3:

- Switch to "ARB > Trigger In > External Delay Unit > Samples".

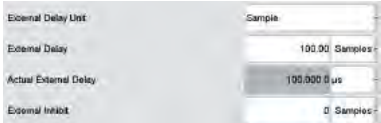
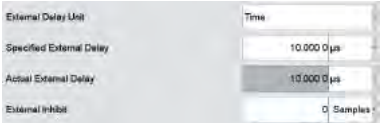
The value of "ARB > Trigger In > External Delay" is 10 samples.

Step 1	Step 2	Step 3
		

Receiving and Providing Trigger Signals

In test setups that combine the signal of two or more instruments it is often required that:

- The signal generation starts at a defined moment
- The signal generation starts simultaneously (or with an exactly defined delay) in all involved instruments.

For information on **simultaneous signal generation start in multiple instruments**, see [Chapter 8.3, "Generating Time-Aligned Baseband Signals"](#), on page 399.

3.4.1.4 Supported Modulation Types

The R&S SMBV100B supports a range of predefined digital and analog modulation types. This section focuses on the possibility to digitally modulate the baseband signal.

The analog modulation methods provided for shifting the frequency bandwidth of the RF signal are described in [Chapter 6.11, "Analog Modulations"](#), on page 319.

In the communication techniques, the commonly used digital modulation schemes are based on keying. From the several existing keying techniques, this instrument supports ASK (amplitude shift keying), FSK (frequency shift keying), PSK (phase shift keying), and QAM (quadrature amplitude modulation). The digital modulation procedure is described by mapping. That is, by the assignment of I and Q values (PSK and QAM) or

frequency shifts (FSK) to every modulation symbol. The resulting modulated signal is graphically represented by a constellation diagram, in that each possible symbol is represented by a discrete point on a complex plane. The number of used bits per symbol is a modulation parameter. The exact position of the symbols on the constellation diagram is determined by the used coding and can be influenced by additionally applied rotation.

Most of the provided modulation schemes are implemented according to a communication standard. The QAM procedures 16QAM, 32QAM, 64QAM for instance have been produced in accordance with ETSI standard ETS 300429 for digital video broadcasting (DVB). The QAM procedures 256QAM and 1024QAM are not specified in this standard, but have been produced according to the same basic principles.

In the case of all FSK procedures, you can set the symbol rate f_{SYMB} up to a maximum value (see data sheet). The frequency deviation (FSK deviation) of the MSK modulation is permanently set to $\frac{1}{4}$ of the symbol rate.

In addition to the common modulation schemes, a variable FSK modulation with definable deviation per symbol is available and for even greater flexibility, a user-defined modulation mapping can be applied (see "User mapping" on page 104).

User mapping

A user-defined modulation mapping file can also be selected as modulation mapping source. The user modulation mapping file must have extension `*.vam` and can be created with the Rohde & Schwarz software tool mapping wizard. The mapping wizard (mapwiz) is a tool from Rohde & Schwarz designed for editing modulation schemes (for example QPSK, 32QAM). Its main purpose is the assignment of logical symbol numbers to constellation points and the selection of modulation-specific parameters. Beyond this, it supports the creation of nearly any arbitrarily chosen constellation diagram. The output of mapwiz is a mapping file (`*.vam`) that can be imported to a R&S SMBV100B. The program was developed on a 32-bit Microsoft Windows platform under MATLAB. For more information, refer to the description "Introduction to "mapwiz" Mapping Editor" at the Rohde & Schwarz webpage.

The remote commands required to define the modulation settings are described in [Chapter 12.16.4.2, "SOURCE:BB:DM Subsystem"](#), on page 683.

Related settings:

- [Chapter 3.5.3.4, "Modulation Settings"](#), on page 121

3.4.1.5 Supported Coding Schemes

Coding is a technique used to improve the signal properties and signal reception and is required only when using some types of modulation. In general, the coding schemes are applied before modulation. The modulation symbols are coded directly before I and Q values or frequency shifts are assigned. The applied coding is directly related to the selected modulation methods. This explains why coding schemes are not freely combinable with the modulation methods.

Refer to [Chapter 3.5.5.1, "Common Coding Algorithms"](#), on page 140 for overview on the available coding combinations. This section also defines the modulation types for which the various coding procedures can be used.

Related settings:

- ["Coding"](#) on page 119

3.4.1.6 Supported Baseband Filters

In the wireless transmission technique, filters are applied to shape the baseband signal before it is modulated on the RF. The selected baseband filter type and shape affect the output stream, especially while generating broadband signals. If the filter is too narrow, it cuts the signal. If the filter is too wide, the signal could be distorted by some unwanted signals.

To fulfill wide range of requirements, the R&S SMBV100B offers a wide selection of predefined baseband filters. The predefined filters are designed for the special spectrum characteristics of the different communication standards. However, depending on the selected filter form one or more filter parameters are provided for even more precise adjustment of the filter characteristic. You can select for example more steeper edges or change the transition bandwidth. For more information on the provided settings, refer to ["Impact of the Filter Parameters"](#) on page 106.

The selection of user-defined filter offers even more flexibility. The later is a useful interface while filters with complex or proprietary form are required. For more information, refer to ["User filter"](#) on page 105.

Predefined baseband filters

Refer to [Chapter 3.5.5.2, "Predefined Baseband Filters"](#), on page 142 for an overview of the available baseband filters.

User filter

The user filter file must have extension `*.vaf` and can be created with the Rohde & Schwarz software tool filter wizard.

The filter wizard (filtwiz) is a tool from Rohde & Schwarz designed for creating filter files that can be imported on a R&S SMBV100B. Its main purpose is the conversion of user-defined finite impulse response (FIR) filters into the filter format (`*.vaf`). Beyond this filt wiz provides designs for standard filters, e.g. root raised cosine (RRC), Gaussian.

The program was developed on a 32-bit Microsoft Windows platform under MATLAB.

For more information, refer to the description "Introduction to "filtwiz" Filter Editor" at the Rohde & Schwarz webpage.

The remote commands required to define the filter settings are described in [Chapter 12.16.4.2, "SOURce:BB:DM Subsystem"](#), on page 683 and the corresponding section in the user manual of each firmware option.

Related settings:

- [Chapter 3.5.3.5, "Filter Settings"](#), on page 124

- Filter settings in the dialogs of the firmware options

Impact of the Filter Parameters

The following is a simple description of the filter parameters and the way they affect the main filter characteristics. Changing filter parameters is an effective way to ensure that the entire bandwidth of the desired signal is allowed to pass and adjust the filter form to reach the spectrum mask requirements

Cut Off Frequency

The cut-off frequency or corner frequency is a filter characteristic that defines the frequency at the 3 dB down point. This frequency is bound to the transition band; here the filter characteristic changes form the passband to the stopband, where the signal is suppressed.

Rolloff Factor

The rolloff factor is a measure for the excess bandwidth compared to the ideal bandwidth of a "brick like" filter. The roll off factor affects the steepness of the filter flanks. A "Rolloff Factor" = 0 would result in the steepest theoretically possible flanks ; values near to 1 make the flanks more flat.

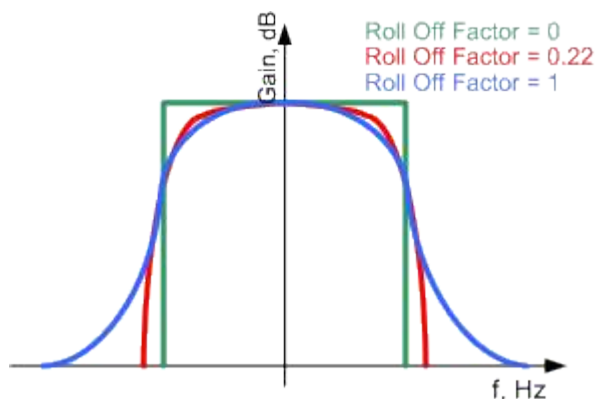

Passband

The passband describes the frequency span that the filter passes unchanged. The total passband of a filter is given as follows:

$$\text{Bandwidth} = (1 + \text{"Roll Off Factor"}) * \text{"Symbol Rate"}$$

Cut Off Frequency Shift

The "Cut Off Frequency Shift" affects the cut-off frequency in the way that the filter flanks are "moved" and the passband increases by "Cut Off Frequency Shift"*"Sample Rate":

$$\text{Cut Off Frequency} = (1 + \text{"Cut Off Frequency Shift"}) * \text{"Sample Rate"}$$

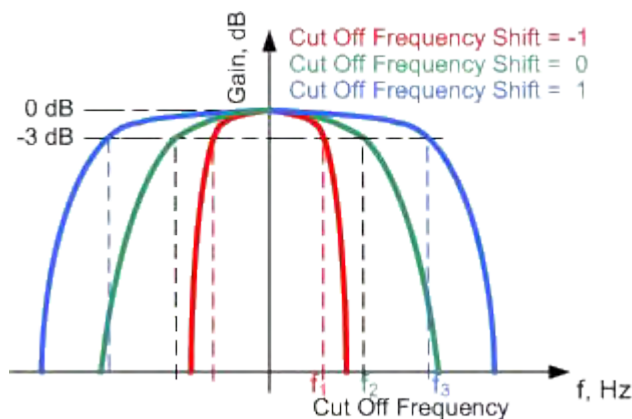

- A "Cut Off Frequency Shift" = -1 results in a very narrow-band filter
- Increasing the value up to 1 makes the filter more broad-band
- By "Cut Off Frequency Shift" = 0, the -3 dB point is at the frequency determined by the half of the selected "Sample Rate".

3.4.1.7 Methods for Optimizing the Crest Factor

Communication standards utilizing higher order modulation techniques or using multiple carrier and complex signals consisting of the signals of more than one digital standard can feature a high crest factor. The signals of some digital standards can have high crest factors also particularly with many channels and long sequences.

The **crest factor** represents the ratio of the peak voltage value to the RMS voltage value, i.e. the peak to average ratio (**PAR**). The higher the crest factor and the resulting dynamics of a signal, the greater the requirement for a power amplifier fed by the signal to be linear. A high crest factor arises for instance, when in a multi carrier signal the carriers feature an identical start phase. This is based on the fact that the carriers are periodically superposed that leads to high peak voltages in relation to the RMS voltage values.

High crest factors entail two basic problems:

- The nonlinearity of the power amplifier (compression) causes intermodulation which expands the spectrum (spectral regrowth).
- Since the level of the D/A converter is relative to the maximum value, the average value is converted with a relatively low resolution. This leads to a high quantization noise.

Both effects increase the adjacent-channel power.

Direct approaches

At the individual signal generation stages, the R&S SMBV100B offers different direct approaches aimed to reduce the crest factor. While the corresponding parameters are enabled, the implemented algorithms ensure minimizing the crest factor or achieving of predefined target crest factor by applying of automatic settings. Methods of reducing the crest factor differ regarding both the optimization achievable and the time required for computation.

The provided crest factor reduction methods include:

- Internal calculation of optimized carrier phases for the individual carriers in a multi carrier signal
- Automatic calculation of the carrier start phases in a multi-carrier continuous wave signal

Applying clipping and filtering

Another common and simple approach for achieving a lower PAR is the combination of clipping and filtering. In several of the firmware options, like 3GPP FDD or CDMA2000, the instrument provides the possibility to enable baseband clipping and to select the baseband filter and, when applicable, to adjust the filter characteristics.

- **Clipping** is a technique that applies a wanted distortion to the signal. The principle includes specifying a threshold, finding out the signal peaks once the defined limits are exceeded and clipping them off. The level limit is specified as a percentage of the highest peak value. Because clipping is done before filtering, the procedure does not influence the spectrum. The error vector magnitude (EVM) however increases.

The instrument offers two clipping modes:

– **Vector $|I + q|$**

The clipping limit is related to the amplitude $|I + q|$. The I and Q components are mapped together, the angle is retained.

– **Scalar $|I| + |q|$**

The clipping limit is related to the absolute maximum of all the I and Q values $|I| + |q|$. The I and Q components are mapped separately, the angle changes.

However, signal clipping not only changes the peak value but also the average value and the effect on the crest factor is unpredictable.

Example:

The following figures demonstrate the effect of the clipping on the crest factor for typical scenarios.

Enabled is clipping with vector mode ($|I+q|$), using a signal configuration with 2 active channels.

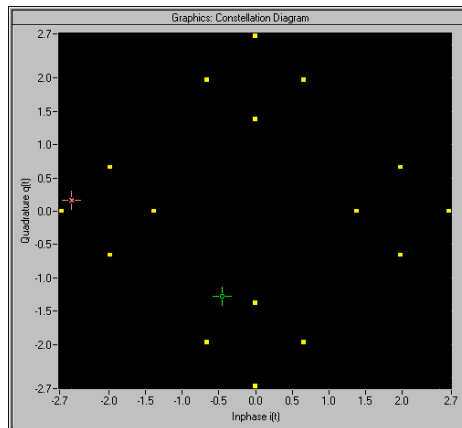

Constellation diagram of the signal without clipping, shows the level mapping

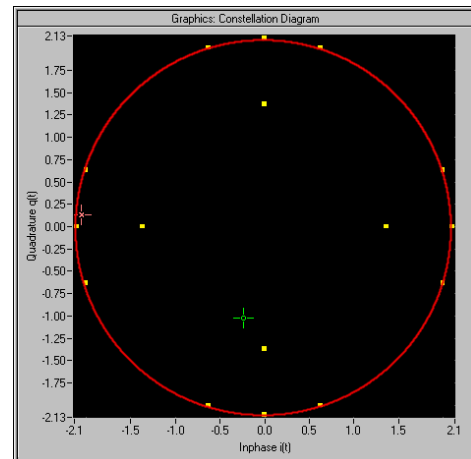

Constellation diagram with clipping level 80%, vector mode ($|I+q|$) The circle emphasizes the changed constellation points

- **Filtering** is applied subsequently. The used filters are specially designed so that they filter out the distortion.

3.4.2 Common Settings

The start dialog of each digital standard follows a repeating dialog structure that comprises the tabs "General", "Trigger In", "Marker" and "Clock".

The "General" tab comprises the primary settings of the standard, the functions for storing and recalling settings. It also provides access to further functions and dialogs, like the "Filter" settings.

The "Trigger In", "Marker" and "Clock" tabs comprise the settings related to the corresponding function.

In the following, we use the "Custom Digital Modulation" dialog to explain the provided common settings. The related remote-control commands are listed in the order "Custom Digital Modulation", "ARB", "Multi Carrier CW".



This section focuses on the available settings.

For more information refer to:

- [Chapter 3.4.1.3, "Baseband Trigger Signals"](#), on page 96.
- [Chapter 3.4.1.2, "Regular Marker Output Signals"](#), on page 94
- ["Clock Signals"](#) on page 91



Routing and enabling a trigger

The provided trigger signals are not dedicated to a particular connector. Trigger signals can be mapped to one or more User x connectors.

Use the [Global Connector Settings](#) to configure the signal mapping, the polarity, the trigger threshold and the input impedance of the input connectors.

To route and enable a trigger signal, perform the following *general steps*:

- Define the signal source and the effect of a trigger event.
Select the "Trigger In > Mode" and "Trigger In > Source".
- Define the connector where the selected signal is provided.
Use the [Global Connector Settings](#).

3.4.2.1 Trigger Settings

Access:

- ▶ Select "Baseband > Custom Digital Mod > Trigger In".

This tab comprises the settings for selecting and configuring the trigger, like trigger source, mode, and delay, and to arm or trigger an internal trigger manually. The current signal generation status is displayed in the header of the tab together with information on the enabled trigger mode. As in the "Marker" and "Clock" tabs, this tab provides also access to the settings of the related connectors.



Settings:

Mode.....	110
Signal Duration.....	111
Running/Stopped.....	111
Arm.....	111
Execute Trigger.....	111
Source.....	111
Sync. Output to External Trigger/Sync. Output to Trigger.....	112
External / Trigger Inhibit.....	112
(External) Delay Unit.....	112
(Specified) External Delay/(Specified) Trigger Delay.....	113
Actual Trigger Delay/Actual External Delay.....	113

Mode

Selects a regular trigger signal: "Auto", "Retrigger", "Armed_Auto", "Armed_Retrigger", or "Single".

Refer to "[Impact of the Trigger Modes on the Signal Generation](#)" on page 97 for a detailed description of the provided trigger modes.

Remote command:

[\[:SOURCE<hw>\]:BB:DM\[:TRIGGER\]:SEQUENCE](#) on page 696

[\[:SOURCE<hw>\]:BB:ARBITRARY\[:TRIGGER\]:SEQUENCE](#) on page 744

[\[:SOURCE<hw>\]:BB:MCCW\[:TRIGGER\]:SEQUENCE](#) on page 785

Signal Duration

Enters the length of the signal sequence to be output in the "Single" trigger mode.

Use this parameter to output part of the signal deliberately, an exact sequence of the signal, or a defined number of repetitions of the signal.

Remote command:

[\[:SOURCE<hw>\]:BB:DM:TRIGGER:SLLENGTH](#) on page 696

[\[:SOURCE<hw>\]:BB:ARBITRARY:TRIGGER:SLUNIT](#) on page 745

[\[:SOURCE<hw>\]:BB:MCCW:TRIGGER:SLLENGTH](#) on page 783

Running/Stopped

With enabled modulation, displays the status of signal generation for all trigger modes.

- "Running"
The signal is generated; a trigger was (internally or externally) initiated in triggered mode.
- "Stopped"
The signal is not generated and the instrument waits for a trigger event.

Remote command:

[\[:SOURCE<hw>\]:BB:DM:TRIGGER:RMODE?](#) on page 697

[\[:SOURCE<hw>\]:BB:ARBITRARY:TRIGGER:RMODE?](#) on page 745

[\[:SOURCE<hw>\]:BB:MCCW:TRIGGER:RMODE?](#) on page 783

Arm

Stops the signal generation until subsequent trigger event occurs.

Remote command:

[\[:SOURCE<hw>\]:BB:DM:TRIGGER:ARM:EXECUTE](#) on page 697

[\[:SOURCE<hw>\]:BB:ARBITRARY:TRIGGER:ARM:EXECUTE](#) on page 745

[\[:SOURCE<hw>\]:BB:MCCW:TRIGGER:ARM:EXECUTE](#) on page 782

Execute Trigger

For internal trigger source, executes trigger manually.

Remote command:

[\[:SOURCE<hw>\]:BB:DM:TRIGGER:EXECUTE](#) on page 697

[\[:SOURCE<hw>\]:BB:ARBITRARY:TRIGGER:EXECUTE](#) on page 746

[\[:SOURCE<hw>\]:BB:MCCW:TRIGGER:EXECUTE](#) on page 783

Source

The following sources of the trigger signal are available:

- "Internal"
The trigger event is executed manually by the "Execute Trigger".
- "External Global Trigger"

The trigger event is the active edge of an external trigger signal provided and configured at the User x connectors.

- "Baseband Sync In"
In master-slave mode, slave instruments are triggered by the active edge of the synchronization signal.

The polarity, the trigger threshold, and the input impedance of the input connectors can be configured in the "Global Connector Settings" dialog.

See:

- ["Trigger Sources"](#) on page 97.

See [Chapter 10.2, "Configuring the Global Connectors"](#), on page 486.

Remote command:

`[:SOURce<hw>] :BB:DM:TRIGger:SOURce` on page 696

`[:SOURce<hw>] :BB:ARBitrary:TRIGger:SOURce` on page 744

`[:SOURce<hw>] :BB:MCCW:TRIGger:SOURce` on page 784

Sync. Output to External Trigger/Sync. Output to Trigger

Enables signal output synchronous to the trigger event.

For a detailed description of the impact of this parameter, see ["Impact of the Additional Trigger Settings"](#) on page 100.

Remote command:

`[:SOURce<hw>] :BB:DM:TRIGger:EXtErnal:SYNChronize:OUTPut`
on page 697

`[:SOURce<hw>] :BB:ARBitrary:TRIGger[:EXtErnal]:SYNChronize:OUTPut`
on page 746

`[:SOURce<hw>] :BB:MCCW:TRIGger:EXtErnal:SYNChronize:OUTPut`
on page 783

External / Trigger Inhibit

Sets the duration with that any following trigger event is suppressed. In "Retrigger" mode for example, a new trigger event does not cause a restart of the signal generation until the specified inhibit duration does not expire.

Applies for:

- External trigger signal

For more information, see ["Impact of the Additional Trigger Settings"](#) on page 100.

Remote command:

`[:SOURce<hw>] :BB:DM:TRIGger[:EXtErnal]:INHibit` on page 699

`[:SOURce<hw>] :BB:ARBitrary:TRIGger[:EXtErnal]:INHibit` on page 747

`[:SOURce<hw>] :BB:MCCW:TRIGger[:EXtErnal]:INHibit` on page 784

(External) Delay Unit

Determine whether the trigger delay is expressed in samples or directly defined as a time period (seconds).

To specify the delay, use the [\(Specified\) External Delay/\(Specified\) Trigger Delay](#)

The parameter [Actual Trigger Delay/Actual External Delay](#) displays the delay converted in time.

See also ["Specifying delay and inhibit values in time units"](#) on page 102.

Remote command:

`[:SOURce<hw>] :BB:DM:TRIGger:DElay:UNIT` on page 698

`[:SOURce<hw>] :BB:ARBitrary:TRIGger:DElay:UNIT` on page 746

(Specified) External Delay/(Specified) Trigger Delay

The name of the parameter and the units the delay is expressed in, changes depending on the parameter [\(External\) Delay Unit](#).

Delays the trigger event provided by:

- The external trigger source
- Other instrument in [master-slave](#) mode

Use the settings to:

- Synchronize the instrument with the device under test (DUT) or other external devices
- Compensate for signal delay and align the signals in time

For more information, see:

- ["Impact of the Additional Trigger Settings"](#) on page 100
- ["Specifying delay and inhibit values in time units"](#) on page 102

The parameter [Actual Trigger Delay/Actual External Delay](#) displays the delay converted in time.

Remote command:

`[:SOURce<hw>] :BB:DM:TRIGger [:EXternal] :DElay` on page 698

`[:SOURce<hw>] :BB:DM:TRIGger [:EXternal] :TDElay` on page 698

`[:SOURce<hw>] :BB:ARBitrary:TRIGger [:EXternal] :DElay` on page 746

`[:SOURce<hw>] :BB:ARBitrary:TRIGger [:EXternal] :TDElay` on page 747

`[:SOURce<hw>] :BB:MCCW:TRIGger [:EXternal] :DElay` on page 784

Actual Trigger Delay/Actual External Delay

Displays the time (in seconds) an external trigger event or a trigger event from the other path is delayed with.

See also ["Specifying delay and inhibit values in time units"](#) on page 102.

Remote command:

`[:SOURce<hw>] :BB:DM:TRIGger [:EXternal] :RDElay?` on page 699

`[:SOURce<hw>] :BB:ARBitrary:TRIGger [:EXternal] :RDElay?` on page 747

3.4.2.2 Marker Settings

Access:

- ▶ Select "Baseband > Custom Dig Mod > Marker".

This tab provides access to the settings necessary to select and configure the marker output signal, like the marker mode or marker delay settings.

**Settings:**

Marker Mode	114
Marker x Delay	114

Marker Mode

Basic marker configuration for up to three marker channels. The contents of the dialog change with the selected marker mode.

Use the settings to define the shape and periodicity of the markers. See [Chapter 3.4.1.2, "Regular Marker Output Signals"](#), on page 94 for description of the regular marker signals.

The instrument routes the generated marker signals to the selected output connectors. See [Chapter 10.2, "Configuring the Global Connectors"](#), on page 486.

"CList" A marker signal as defined in the selected control list.

Remote command:

[:SOURce<hw>] :BB:DM:TRIGger:OUTPut<ch>:MODE on page 699

[:SOURce<hw>] :BB:DM:TRIGger:OUTPut<ch>:PULSe:DIVider on page 700

[:SOURce<hw>] :BB:DM:TRIGger:OUTPut<ch>:PULSe:FREQuency?
on page 700

[:SOURce<hw>] :BB:DM:TRIGger:OUTPut<ch>:PATtern on page 700

[:SOURce<hw>] :BB:DM:TRIGger:OUTPut<ch>:OFFTime on page 700

[:SOURce<hw>] :BB:DM:TRIGger:OUTPut<ch>:ONTime on page 700

ARB: see ["Marker Mode"](#) on page 158

[:SOURce<hw>] :BB:MCCW:TRIGger:OUTPut<ch>:MODE on page 785

[:SOURce<hw>] :BB:MCCW:TRIGger:OUTPut<ch>:PULSe:DIVider on page 786

[:SOURce<hw>] :BB:MCCW:TRIGger:OUTPut<ch>:PULSe:FREQuency?
on page 786

[:SOURce<hw>] :BB:MCCW:TRIGger:OUTPut<ch>:PATtern on page 786

[:SOURce<hw>] :BB:MCCW:TRIGger:OUTPut<ch>:ONTime on page 785

[:SOURce<hw>] :BB:MCCW:TRIGger:OUTPut<ch>:OFFTime on page 785

Marker x Delay

Delays the marker signal at the marker output relative to the signal generation start.

Variation of the parameter "Marker x Delay" causes signal recalculation.

Remote command:

[:SOURce<hw>] :BB:DM:TRIGger:OUTPut<ch>:DELay on page 701

[:SOURce<hw>] :BB:ARBitrary:TRIGger:OUTPut<ch>:DELay on page 749

[:SOURce<hw>] :BB:MCCW:TRIGger:OUTPut<ch>:DELay on page 786

3.4.2.3 Clock Settings

Access:

- ▶ Select "Baseband > Custom Dig Mod > Clock".

This tab provides access to the settings necessary to select and configure the clock signal, like the clock source and clock mode.

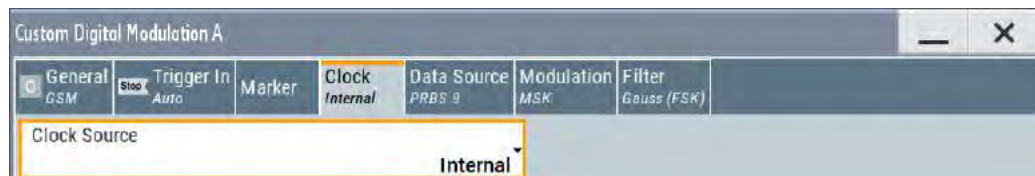

Settings:

Clock Source..... 115

Clock Source

Selects the clock source.

- "Clock Signals" on page 91

Selects the clock source.

- "Internal"
The instrument uses its internal clock reference.

Remote command:

[:SOURce<hw>] :BB:DM:CLOCK:SOURce on page 701

[:SOURce<hw>] :BB:ARBitrary:CLOCK:SOURce on page 749

[:SOURce<hw>] :BB:MCCW:CLOCK:SOURce on page 787

3.4.2.4 Global Connector Settings

Each of the "Trigger In", "Marker" and "Clock" dialogs as well as the "Trigger Marker Clock" dialog provides a quick access to the related connector settings.

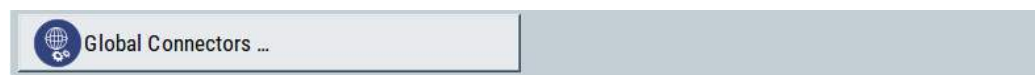

For more information, refer to the description R&S SMBV100B user manual, section "Global Connector Settings".

3.5 Generating Custom Digital Modulated Signals

The R&S SMBV100B can generate digital modulation signals with user-definable characteristics. The baseband filtering and the symbol rate can be set within wide limits.

3.5.1 Required Options

The equipment layout for generating the digital modulation signals includes:

- Base unit
- Option custom digital modulation (R&S SMBVB-K520)

3.5.2 About the Custom Digital Modulation

An introduction to the supported filter, modulation, and coding schemes are provided in:

- [Chapter 3.4.1.6, "Supported Baseband Filters"](#), on page 105
- [Chapter 3.4.1.4, "Supported Modulation Types"](#), on page 103
- [Chapter 3.4.1.5, "Supported Coding Schemes"](#), on page 104.

Interdependency between selected modulation type and coding scheme and handling of conflicting settings

The applied coding is directly related to the selected modulation methods. The available coding schemes listed in [Chapter 3.5.5.1, "Common Coding Algorithms"](#), on page 140 are not freely combinable with modulation methods.

Obviously, having selected a modulation procedure, not every combination of the further modulation parameters "Symbol Rate" and "Coding" is possible. These restrictions inevitably result in conflicting settings if you change a parameter and leads to a prohibited combination.

An inappropriate change of a parameter triggers a settings conflict, which is indicated by a message on the "Info" line in the display. Although the R&S SMBV100B displays the selected settings, the generated modulation signal does not correspond to this display. The displayed message disappears when a conflict-free setting is selected.

Refer to [Chapter 14, "Troubleshooting and Error Messages"](#), on page 938 for a list of the possible settings conflicts and messages in digital modulation.

3.5.3 Custom Digital Modulation Settings

Access:

- ▶ Select "Baseband > Custom Digital Mod".

The "Custom Digital Modulation" dialog enables direct selection of the data source, standard, symbol rate, coding, modulation type and filter.

The dialog is divided into several tabs. In each case, the current setting is displayed in the tab name.

The remote commands required to define these settings are described in [Chapter 12.16.4.2, "SOURce:BB:DM Subsystem"](#), on page 683.

Settings:

• General Settings	117
• Trigger, Marker and Clock Setting	119
• Data Source	119
• Modulation Settings	121
• Filter Settings	124
• Power Ramp Control Settings	126
• Data List Editor	128
• Control and Marker Lists Editor	130

3.5.3.1 General Settings

Access:

- ▶ Select "Baseband > Custom Digital Mod".

This tab provides access to the default and the save/recall settings, and to a quick selection of a digital modulation according to predefined communication standard.



Settings:

State	118
Set To Default	118
Save/Recall	118
Set according to Standard	118

Symbol Rate.....	119
Coding.....	119
Power Ramp Control.....	119

State

Enables/disables digital modulation. Switching on digital modulation turns off all other digital standards.

The digital modulation is generated in real time (no precalculated signal), and therefore while the digital modulation is enabled, all parameter changes directly affect the output signal.

Remote command:

[:SOURce<hw>] :BB:DM:STATe on page 685

Set To Default

Calls default settings. The values are listed in [Table 3-5](#).

Remote command:

[:SOURce<hw>] :BB:DM:PRESet on page 686

Save/Recall

Accesses the "Save/Recall" dialog, that is the standard instrument function for saving and recalling the complete dialog-related settings in a file. The provided navigation possibilities in the dialog are self-explanatory.

The filename and the directory, in which the settings are stored, are user-definable; the file extension is however predefined.

See also [Chapter 9, "File and Data Management"](#), on page 442.

Remote command:

[:SOURce<hw>] :BB:DM:SETTing:CATalog? on page 687

[:SOURce<hw>] :BB:DM:SETTing:DELeTe on page 689

[:SOURce<hw>] :BB:DM:SETTing:LOAD on page 688

[:SOURce<hw>] :BB:DM:SETTing:STORe on page 688

Set according to Standard

Selects a predefined communication standard.

"Predefined communication standard"

Selects a predefined communication standard.

A subset of parameters is automatically adjusted: "Modulation Type", "Symbol Rate", "Filter" and "Coding".

Refer to [Table 3-6](#) for an overview of the available standards and the associated settings of the modulation parameters.

"User"

Set automatically, this value indicates a modification made on at least one of the parameters.

Use the "Save/Recall" function to store and recall customized settings.

Remote command:

[:SOURce<hw>] :BB:DM:STANdard on page 686

Symbol Rate

Selects the symbol rate. The value range of this parameter depends on the selected modulation type; the range is automatically redefined.

An error message appears if the selected symbol rate is outside of the redefined range. The symbol rate is set automatically to the maximum allowed value for the new modulation.

Remote command:

`[:SOURce<hw>] :BB:DM:SRATe` on page 686

Coding

Selects the coding (see [Chapter 3.4.1.5, "Supported Coding Schemes"](#), on page 104).

The dialog shows only the coding settings that are permissible for the selected modulation type and installed options (see [Table 3-8](#)). All other coding methods are grayed out.

A subsequent modification to a modulation type for which the selected coding is not available, automatically disables the coding ("Coding = Off").

Remote command:

`[:SOURce<hw>] :BB:DM:CODing` on page 690

Power Ramp Control

Accesses the power ramp control dialog, see [Chapter 3.5.3.6, "Power Ramp Control Settings"](#), on page 126.

3.5.3.2 Trigger, Marker and Clock Setting

These tabs provide standard settings.

For detailed description, see:

- [Chapter 3.4.2.1, "Trigger Settings"](#), on page 110
- [Chapter 3.4.2.2, "Marker Settings"](#), on page 113
- [Chapter 3.4.2.3, "Clock Settings"](#), on page 115
- [Chapter 3.4.2.4, "Global Connector Settings"](#), on page 115

3.5.3.3 Data Source

Access:

- ▶ Select "Baseband > Custom Digital Mod > Data Source".

This tab provides access to the settings necessary to select and configure the data source, like access to data and list editors or direct selection of PRBS data.

For an overview of the supported data sources, refer to [Chapter 3.4.1.1, "Data, Clock and Control Signals and Sources in the Baseband"](#), on page 89.

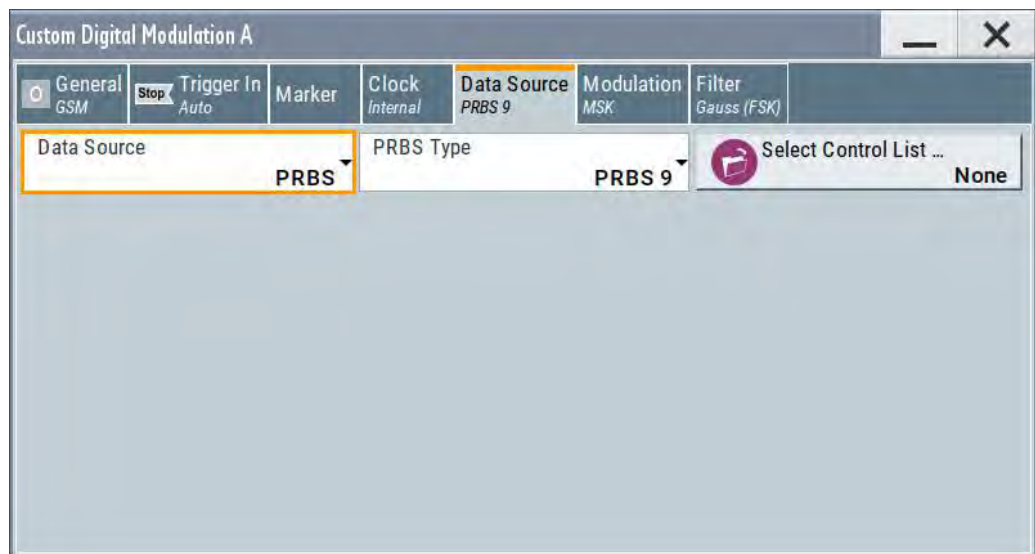
**Settings:**

Data Source.....	120
Select Data List.....	121
Select Control List.....	121
Connector Settings.....	121

Data Source

Selects the data source (see [Chapter 3.4.1.1, "Data, Clock and Control Signals and Sources in the Baseband"](#), on page 89).

The following data sources are available:

"All 0, All 1" A sequence containing 0 data or 1 data is internally generated.

"PRBS, PRBS Type"

Selects internally generated PRBS data in accordance with the IUT-T. Use the parameter "PRBS Type" to define the length.

Remote command:

`[:SOURce<hw>] :BB:DM:PRBS [:LENGth]` on page 687

"Pattern" Use the "Pattern" box to define a bit pattern with a maximum length of 64 bits.

Remote command:

`[:SOURce<hw>] :BB:DM:PATtern` on page 687

"Data List"

Binary data from data lists are used, see [Select Data List](#).

Remote command:

`[:SOURce<hw>] :BB:DM:DLISt:CATalog?` on page 701

`[:SOURce<hw>] :BB:DM:DLISt:SElect` on page 702

Remote command:

`[:SOURce<hw>] :BB:DM:SOURce` on page 686

Select Data List

Accesses the standard "Select List" dialog to select an existing data list or to create a new one.

Data lists can be generated externally or internally in the data editor.

- Select the "Select Data List > navigate to the list file *.dm_iqd > Select" to select an existing data list.
- Use the standard "File Manager" function to transfer external data lists to the instrument.
- Use the "New" and "Edit" functions to create internally new data list or to edit an existing one, see [Chapter 3.5.3.7, "Data List Editor"](#), on page 128.

See also [Chapter 3.5.4.2, "How to Create and Assign a Data List"](#), on page 136

Remote command:

[:SOURce<hw>] :BB:DM:DLISt:CATalog? on page 701

[:SOURce<hw>] :BB:DM:DLISt:SElect on page 702

[:SOURce<hw>] :BB:DM:DLISt:COpy on page 705

[:SOURce<hw>] :BB:DM:DLISt:DElete on page 703

Select Control List

Accesses the standard "Select List" dialog to select an existing control list or to create a new one.

Control lists can be generated externally or internally in the "Control and Marker Lists" editor.

- Select the "Select Control List > navigate to the list file *.dm_iqc > Select" to select an existing control list.
- Use the standard "File Manager" function to transfer external lists to the instrument.
- Use the "New" and "Edit" functions to create internally new list or to edit an existing one, see [Chapter 3.5.3.8, "Control and Marker Lists Editor"](#), on page 130.

Irrespectively on the way they are created, control lists are not automatically used (see ["How to assign and activate control signals from a control list"](#) on page 135).

Remote command:

[:SOURce<hw>] :BB:DM:CLISt:CATalog? on page 701

[:SOURce<hw>] :BB:DM:CLISt:SElect on page 702

[:SOURce<hw>] :BB:DM:CLISt:COpy on page 705

[:SOURce<hw>] :BB:DM:CLISt:DElete on page 703

Connector Settings

Accesses the connectors settings.

See [Chapter 10.2, "Configuring the Global Connectors"](#), on page 486.

3.5.3.4 Modulation Settings

Access:

- ▶ Select "Baseband > Custom Digital Mod > Modulation".

This tab provides access to the modulation settings, e.g modulation type, FSK deviation, or modulation depth. The dialog shows the theoretical constellation diagram of the selected modulation.



This section focuses on the available settings. For background information on how the settings affect the signal and the filter characteristics, refer to [Chapter 3.4.1.4, "Supported Modulation Types"](#), on page 103.



Settings:

Modulation Type.....	122
Load User Mapping.....	123
ASK Depth.....	123
FSK Deviation.....	123
Angle Alpha.....	123
FSK Type.....	123
Deviation xxxx.....	124
Gamma/Gamma 1.....	124
State Modulation CW Switching.....	124

Modulation Type

Selects a modulation type. The associated symbol mapping is displayed.

If the selected "Coding" is not allowed with the configured modulation type, the value of the parameter [Coding](#) is set to "Off".

Refer to [Table 3-7](#) for an overview of the allowed combinations.

Remote command:

[:SOURce<hw>] :BB:DM:FORMat on page 691

Load User Mapping

Accesses the "Select List File User Mapping" dialog to select the mapping table (see "User mapping" on page 104). The dialog provides all standard file management functions.

Remote command:

`[:SOURce<hw>] :BB:DM:MLIST:SElect` on page 702

`[:SOURce<hw>] :BB:DM:MLIST:CATalog?` on page 701

`[:SOURce<hw>] :BB:DM:MLIST:DElete` on page 703

ASK Depth

Sets the modulation depth m for ASK modulation.

$$m = (Amplitude_{max} - Amplitude_{min}) / (Amplitude_{max} + Amplitude_{min})$$

Remote command:

`[:SOURce<hw>] :BB:DM:ASK:DEPTh` on page 692

FSK Deviation

Sets the frequency deviation for FSK modulation. The range of values depends on the selected [Symbol Rate](#) (see data sheet).

Whenever "MSK" is selected, the deviation corresponds to 1/4 of the symbol rate and cannot be changed.

Remote command:

`[:SOURce<hw>] :BB:DM:FSK:DEVIation` on page 692

Angle Alpha

For AQPSK modulation, sets the angle alpha between the point (0,0) and the I axis.

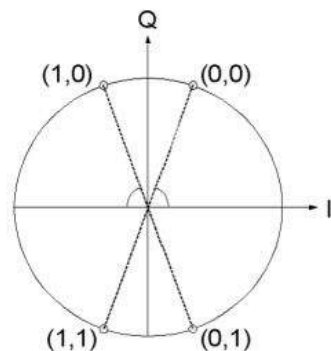

Remote command:

`[:SOURce<hw>] :BB:DM:AQPSk:ANGLE` on page 691

FSK Type

For "Variable FSK", selects the FSK modulation type.

Available are 4FSK, 8FSK and 16FSK.

Remote command:

`[:SOURce<hw>] :BB:DM:FSK:VARiable:TYPE` on page 693

Deviation xxxx

For "Variable FSK", sets the deviation of the associated symbol. The number of symbols depends on the selected modulation type. The value of each symbol is indicated in binary format.

Remote command:

`[:SOURce<hw>] :BB:DM:FSK:VARIABLE:SYMBOL<ch0>:DEVIATION` on page 692

Gamma/Gamma 1

Selects the gamma function γ for the 16APSK and 32APSK modulations.

The values in brackets indicate the used code rate according to the DVB-S2 specification.

Remote command:

`[:SOURce<hw>] :BB:DM:APSK16:GAMMA` on page 693

`[:SOURce<hw>] :BB:DM:APSK32:GAMMA` on page 693

State Modulation CW Switching

Enables/disables switching between the digitally modulated and an unmodulated (CW) signal.

Remote command:

`[:SOURce<hw>] :BB:DM:SWITCHING:STATE` on page 693

3.5.3.5 Filter Settings

Access:

- ▶ Select "Baseband > Custom Digital Mod > Filter".

This tab provides access to the filter settings, like filter type and if available further filter settings. A simplified diagram shows the filter characteristic of the selected filter.



This section focuses on the available settings. For background information on how the settings affect the signal and the filter characteristics, refer to [Chapter 3.4.1.6, "Supported Baseband Filters"](#), on page 105.

**Settings:**

Filter.....	125
Filter Parameter.....	125
Cutoff Frequency Factor.....	125
Bandwidth.....	126
Load User Filter.....	126

Filter

Selects the baseband filter.

Refer to [Chapter 3.5.5.2, "Predefined Baseband Filters"](#), on page 142 for overview of the available filter types, their filter shapes and filter parameters.

Remote command:

`[:SOURce<hw>] :BB:DM:FILTer:TYPE` on page 689

Filter Parameter

Sets the corresponding filter parameter.

The filter parameter offered ("Rolloff Factor" or "BxT") depends on the currently selected filter type.

Remote command:

`[:SOURce<hw>] :BB:DM:FILTer:PARAmeter:APCO25` on page 689

`[:SOURce<hw>] :BB:DM:FILTer:PARAmeter:COSine[:ROLLoff]` on page 689

`[:SOURce<hw>] :BB:DM:FILTer:PARAmeter:GAUSSs` on page 689

`[:SOURce<hw>] :BB:DM:FILTer:PARAmeter:PGAuss` on page 689

`[:SOURce<hw>] :BB:DM:FILTer:PARAmeter:RCOSine` on page 689

`[:SOURce<hw>] :BB:DM:FILTer:PARAmeter:SPHase` on page 689

Cutoff Frequency Factor

(available for filter parameter Lowpass and APCO25 (LSM))

Sets the value of the cutoff frequency factor. The cutoff frequency of the filter can be adjusted to reach spectrum mask requirements.

Remote command:

[:SOURce<hw>] :BB:DM:FILTer:PARAmeter:LPASs on page 689

[:SOURce<hw>] :BB:DM:FILTer:PARAmeter:LPASSEVM on page 689

[:SOURce<hw>] :BB:DM:FILTer:PARAmeter:APCO25Lsm:GAUSS on page 689

[:SOURce<hw>] :BB:DM:FILTer:PARAmeter:APCO25Lsm:LOWPass on page 689

Bandwidth

Determines the bandwidth of the cosine filter, so that the function in $H(f) = 0$ is fulfilled for $f \geq (1 + \text{Rolloff}) * \text{Bandwidth} / 2$.

Remote command:

[:SOURce<hw>] :BB:DM:FILTer:PARAmeter:COSine:BANDwidth on page 689

Load User Filter

Calls the dialog "Select User Filter" for selecting a user-defined filter file with extension *.vaf (see "User filter" on page 105). The dialog provides access to the standard file management functions, like store, load, delete.

Remote command:

[:SOURce<hw>] :BB:DM:FLISt:SElect on page 702

[:SOURce<hw>] :BB:DM:FLISt:CATalog? on page 701

[:SOURce<hw>] :BB:DM:FLISt:DElete on page 703

3.5.3.6 Power Ramp Control Settings

Access:

- ▶ Select "Baseband > Custom Digital Modulation > General > Power Ramp Control".

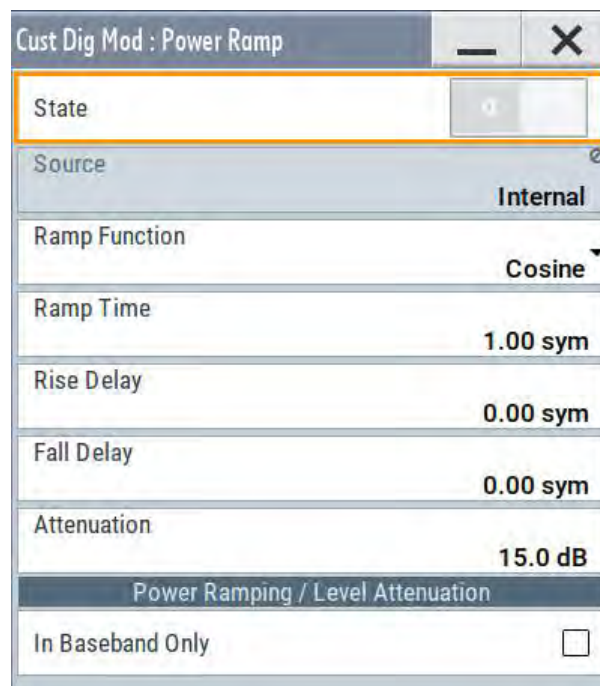

The dialog comprises the settings used to configure the power ramping, like the source of the control signals, the form of the ramp function and the applied attenuation.

See also "[Power Ramping and Level Attenuation](#)" on page 92.



Power ramping is possible up to a symbol rate of 5 MHz. A higher symbol rate disables the power ramping automatically and an error message is output.

Settings:

State.....	127
Source.....	127
Ramp Function.....	127
Ramp Time.....	127
Rise Delay.....	128
Fall Delay.....	128
Attenuation.....	128
In Baseband Only.....	128

State

Enables/disables power ramping.

Remote command:

[:SOURce<hw>] :BB:DM:PRAMP [:STATe] on page 695

Source

Defines the source for the power ramp control signals.

"Internal" The control signals as defined in the internal control list are used for control purposes.
See also [Chapter 3.5.4.1, "How to Create and Assign a Control List"](#), on page 134.

Remote command:

[:SOURce<hw>] :BB:DM:PRAMP:SOURce on page 694

Ramp Function

Selects the ramp function that describes the shape of the rising and falling edges during power ramp control, see [Figure 3-3](#).

"Linear" The transmitted power rises and falls linear fashion.

"Cosine" The transmitted power rises and falls with a cosine-shaped edge, resulting in a more favorable spectrum than the "Linear" setting.

Remote command:

[:SOURce<hw>] :BB:DM:PRAMP:SHAPE on page 694

Ramp Time

Enters the power ramping rise time and the fall time for a burst. The setting is expressed in symbols. See also [Figure 3-3](#).

Remote command:

[:SOURce<hw>] :BB:DM:PRAMP:TIME on page 694

Rise Delay

Sets the offset in the rising edge of the envelope at the start of a burst, see [Figure 3-3](#).

A positive value delays (the envelope length decreases) and a negative value causes an advance (the envelope length increases). The setting is expressed in symbols.

Remote command:

[:SOURce<hw>] :BB:DM:PRAMp:RDELay on page 694

Fall Delay

Sets the offset in the falling edge of the envelope at the end of a burst, see [Figure 3-3](#).

A positive value delays (the envelope length increases) and a negative value causes an advance (the envelope length decreases). The setting is expressed in symbols.

Remote command:

[:SOURce<hw>] :BB:DM:PRAMp:FDELay on page 694

Attenuation

Determines the level by that the average signal level is attenuated during the signal attenuation period, during the time the "Lev_Att" signal is high. See also [Figure 3-2](#).

For information about the required control signal, refer to "[Power Ramping and Level Attenuation](#)" on page 92.

Remote command:

[:SOURce<hw>] :BB:DM:PRAMp:ATTenuation on page 695

In Baseband Only

Restricts power ramping to the baseband signal.

"Off" Level attenuation is affected via the attenuator stages in the RF section; only the remaining part is attenuated in the baseband. The signal is issued at the RF output with the defined level values.

"On" Level attenuation is affected in the baseband only.

Note:

This setting is mandatory in the following cases:

- When only the baseband signal is issued at the I/Q outputs
It is thus ensured that, with power ramping active, this signal is output with the defined level values.
- For two-path instruments, when one baseband signal is applied to two RF paths.

Remote command:

[:SOURce<hw>] :BB:DM:PRAMp:BBONly [:STATe] on page 695

3.5.3.7 Data List Editor

The R&S SMBV100B provides the following ways to create a data list file:

- To use the dedicated "Data List Editor" and create a file with extension *.dm_iqd, see "[To create data lists manually](#)" on page 136
- To use the tag-oriented format and create a data list file, see "[To create a data list file using tag file format](#)" on page 769

- To use SCPI commands and create a file in binary format, see ["To create a data list in binary format"](#) on page 770

Access:

1. Select "Baseband > Custom Digital Mod > Data Source > Data List".
2. Select "Select Data List".
3. Navigate to the required directory.
Select "New" and enter a filename.
For example, in the directory `/var/user/`, enter "Filename" = `dl_3gpp`

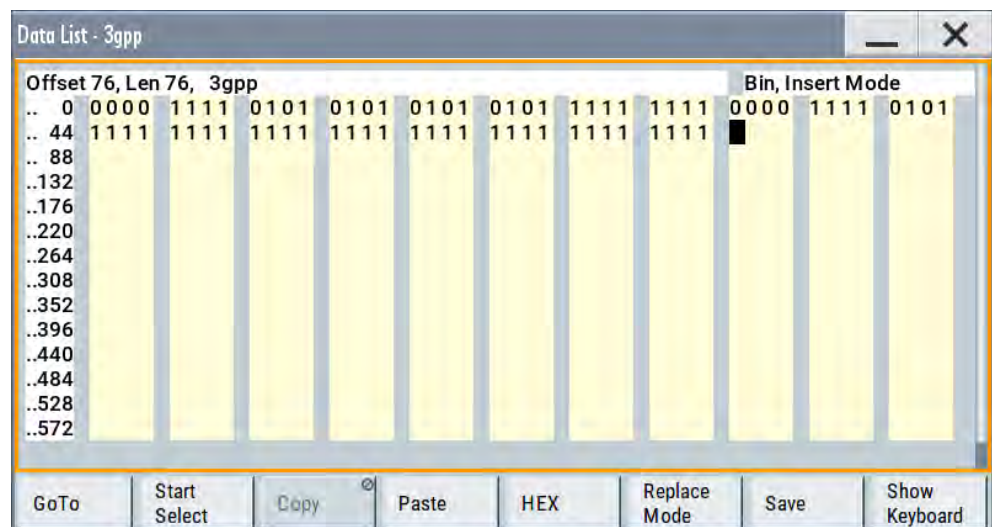

The "Data List Editor" is a list of binary values with a maximum length of 2^{31} bits.

This value corresponds to a file size of approx. 268 Mbyte.

To increase readability, the bits are displayed in groups of four. The current cursor position, the length of the list and the list filename are displayed above the list. The offset starts with the value 0 which corresponds to the bit position on the left side of the first row, i.e. the beginning of the list. On the left edge of the editor, the last three offset positions are specified at the beginning of the row.

An existing list can be edited in the insert or replace mode. The upper right corner shows the current mode.

SCPI command:

[\[:SOURce<hw>\]:BB:DM:DLIST:SElect](#) on page 702

[\[:SOURce<hw>\]:BB:DM:DLIST:DATA](#) on page 706

[\[:SOURce<hw>\]:BB:DM:DLIST:DATA:APPend](#) on page 707

The buttons below the binary list simplify the editing.

Settings:

GoTo

Opens the entry window for the bit position. The cursor marks the bit at the selected position.

Start Select/Undo Select

Defines the current cursor position as the start position for the range to be selected. To define the stop position, select "GoTo > Go To Offset" and define the offset.

Selecting "Undo Select" deactivates the selected range.

Copy, Cut, Paste

Standard copy, cut, and paste functions.

HEX/BIN

Switches between hexadecimal and binary display.

Each 4 bits group is displayed as a hexadecimal value. To increase readability, the hexadecimal values in turn are displayed in pairs of two.

The hex functions are automatically assigned to the numeric keys at the front panel.

Replace/Insert Mode

Switches between replace and insert mode to enter new or replace old values.

Save

Saves the changes into the selected data list file.

Show/Hide Keyboard

Accesses a virtual keyboard to enter Hex/Bin values.

3.5.3.8 Control and Marker Lists Editor

The R&S SMBV100B provides the following ways to create a file containing control signals:

- To use the tag-oriented format and create a control list file, see ["To create a control list using tag file format"](#) on page 768
- To use SCPI commands and create a file in binary format, see ["To create a control list in binary format"](#) on page 768
- To use the dedicated "Control Data Editor" and create a file in ASCII format and with extension `*.dm_iqc`.
The "Control Data Editor" is described in this section. Refer to ["To create a control list in ASCII format manually"](#) on page 134 for step-by-step instructions.

To access the "Control Data Editor":

1. Select "Baseband > Custom Digital Mod > Data Source".
2. Select "Select Control List".
3. Navigate to the required directory, for example `/var/user/`.
Select "New".
4. In the "Filename" field, enter the name of the new control list, for example `dl_3gpp`.

5. Select "Edit".

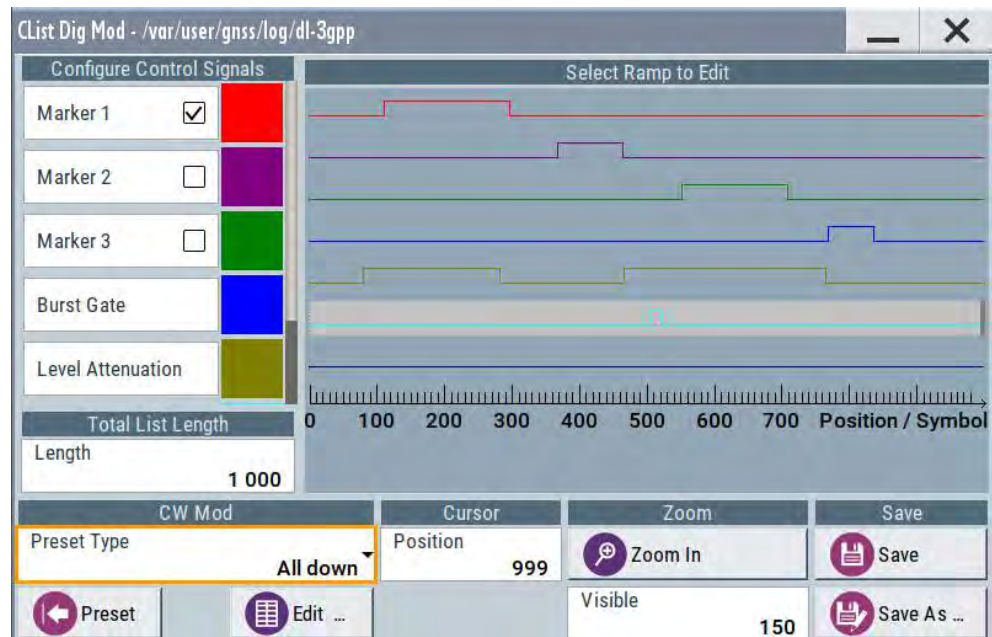

The dedicated internal "Control Data Editor" is an intuitive graphical interface provided for defining and managing of:

- Marker signals
- Control signals, like the CW, "Hop", "Burst Gate", and "Lev_Att" control signals (see also "Control Signals" on page 92)

A separate file with the file extension `*.dm_iqc` is created for each defined control signal and held on the instrument's hard disk. Control lists created with the editor are files in an ASCII file format.

In the "Control Data Editor" dialog, the available marker and control signals are displayed color-coded. The "Select Ramp to Edit" is a graphical display of the signal characteristics. To define the ramp for the individual markers or control signals, tap on the desired position or use the provided support functions "<Signal> Table" and "Cursor Position". To simplify the settings, use the predefined preset ramp characteristics in the "<Signal> Preset Type" section. The scaling of the x-axis is always adapted to the overall length of the control list to provide constant overview of all defined ramps. For detailed representation, zoom the displayed area around the current cursor position.

In the "Configure Control Signal" section, a status checkbox indicates whether the individual marker or control signal is assigned or enabled (see [Chapter 3.5.4.1, "How to Create and Assign a Control List"](#), on page 134).

SCPI command:

`[:SOURce<hw>] :BB:DM:CLIST:CATalog?` on page 701

`[:SOURce<hw>] :BB:DM:CLIST:SElect` on page 702

Settings:

Configure Control Signal	132
Select Ramp to Edit	132
Total List Length	132

Preset Type.....	132
Cursor Position.....	133
Positions Control Signal.....	133
Zoom/Visible.....	133
Save/Save As.....	134

Configure Control Signal

Displays the color the marker/control signal has been assigned.

The status checkbox indicates whether the individual marker or control signal is assigned or enabled (see [Chapter 3.5.4.1, "How to Create and Assign a Control List"](#), on page 134).

Remote command:

n.a.

Select Ramp to Edit

Graphical representation for editing of the marker/control signals.

Refer to [Chapter 3.5.4.1, "How to Create and Assign a Control List"](#), on page 134 for an overview of the editing capabilities of the display.

Remote command:

```
{[TRACE] LIST [#]: Pos0:State0; Pos1:State1; ...PosN-1:StateN-1}
```

on page 757

```
[ :SOURCE<hw> ] :BB:DM:CLIST:DATA
```

on page 705

Total List Length

Enters the length of the definition range of the control list in bits. The starting value is always bit 0. The entire definition range is displayed, i.e. the bit scale is adapted to the entry. If the definition range is decreased, the ramps outside the range are lost.

When used, the control list is always repeated over the length of the definition range if the length of the data list exceeds the length of the control list.

Tip: With long control lists, it is useful to zoom the displayed area around the current cursor position ("Zoom in").

Remote command:

```
{CONTROL LENGTH: ControlLength}
```

on page 755

Preset Type

Triggered with "Preset", presets for the ramp characteristic of the selected control signal as defined with the "Preset Type".

"All Up, All Down "

Continuously high/low marker/control signal.

"Ramp Up, Ramp Down"

A ramp from low to high or from high to low is configured in the center of the displayed signal area; ramp position can be later shifted as required.

"Ramp Up/Down, Ramp Down/Up"

Created is a ramp sequence of low to high and high to low transitions, respectively high to low, and low to high transitions. The ramps are symmetrically distributed around the center of the displayed signal area but be later shifted as required.

Remote command:

n.a.

Cursor Position

Displays/enters the cursor position in the graphical display

If the entered value exceeds the selected length of the definition range, the length is adjusted automatically.

Remote command:

n.a.

Positions Control Signal

Select "Edit ..." to access a dialog with representation of the ramps of the selected signal in table form.

	Ramp Position	Ramp State
0	0	Low
1	82	High
2	284	Low
3	468	High
4	767	Low
5		

Accept

The bit position is specified in the "Ramp Position" column, the high or low signal status in the "Ramp State" column. Use the last blank row to enter new ramps.

To apply the changes, press "Accept".

Remote command:

n.a.

Zoom/Visible

Zooms the displayed area of the control list. The designation of the button changes from "Zoom in" to "Zoom out".

With long control lists, it is helpful to display only a part of the control list. In such cases, set the "Visible/Bits Visible" to determine the number of symbols/bits to be displayed and select "Zoom" to focus the displayed area around the current "Cursor Position".

Ramps outside the displayed area are not lost by zooming.

Remote command:

n.a.

Save/Save As

Stores the changes in the selected control list file or in a new file.

Remote command:

n.a.

3.5.4 How to Create Data and Control Lists

This section provides step-by-step instructions on configuring and using the provided settings. For details on individual functions and settings, see [Chapter 3.5.3, "Custom Digital Modulation Settings"](#), on page 116.

3.5.4.1 How to Create and Assign a Control List

The R&S SMBV100B provides the following ways to create a file containing control signals:

- To use the dedicated [Control and Marker Lists Editor](#) and create a file in ASCII format and with extension *.dm_iqc, see ["To create a control list in ASCII format manually"](#) on page 134
- To use the tag-oriented format and create a control list file, see ["To create a control list using tag file format"](#) on page 768
- To use SCPI commands and create a file in binary format, see ["To create a control list in binary format"](#) on page 768

To create a control list in ASCII format manually

Use the intuitive build in [Control and Marker Lists Editor](#) dialog:

1. To open the "Control Data Editor":
 - a) Select "Baseband > Custom Digital Mod > Data Source > Select Control List".
 - b) Select an existing file or select "New".

If the selected file is an existing one, the dialog shows the used settings.

If a new file has been created, the control list is empty.

2. Adjust the control signals as required.
 - a) In the graphic editor "Select Ramp to Edit", select the color-coded trace of the required signal.
 - b) Tap at a position which requires a ramp. The number of ramps per marker is unlimited.

- c) To remove a ramp, place the cursor at the desired ramp position. Press the [Backspace] key.
- d) For faster marker and control signal definition, use the predefined ramp functions ("Preset Type"). Apply them with "Preset".
- e) If necessary, readjust the ramps with the help of the "Edit" function.
- f) Define the "Total List Length".
- g) To display only a part of the control list, set the "Visible/Bits Visible" to determine the number of displayed symbols/bits.
Select "Zoom" to focus the displayed area around the current "Cursor Position".

Ramps outside the displayed area are not lost.

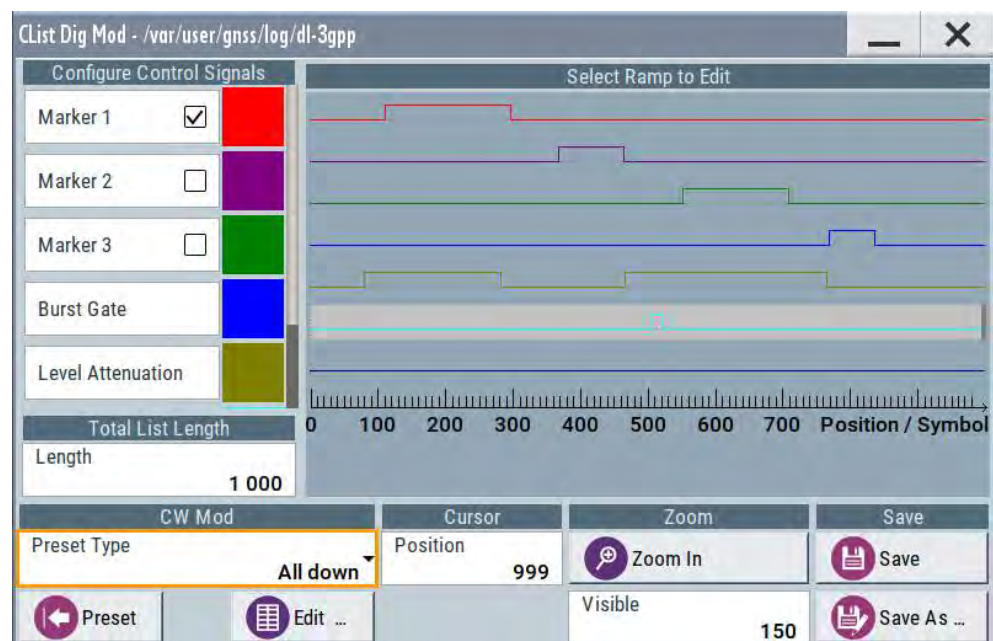

Figure 3-10: Example of control list settings

3. Select "Save" or "Save As" to store the used settings as a control list file.

The created file is an ASCII file with the extension `*.dm_iqc`

Enable the instrument to use the control list, e.g. for the marker and/or other control signals.

Enabled control signals are indicated as active in the "Configure Control Signal" section.

How to assign and activate control signals from a control list

Irrespectively on the way they are created, generated control lists are not automatically used.

To use a marker/control signal from a control list and to output this signal at the supported connector, perform the following:

1. Enable the R&S SMBV100B to use the control list for marker output 2.
Output this signal at the User2 connector:

- a) Select "Baseband > Custom Digital Modulation > Marker > Marker 2 Mode > CList".
 - b) Select "Baseband > Custom Digital Modulation > Marker > Global Connector Setting".
Select "User 2 > Direction = Output", "User 2 > Signal = Baseband Marker 2".
2. To enable the R&S SMBV100B to use the Burst Gate and Level Attenuation control signals as defined in a control list and output one of them at the User3 connector:
 - a) Select "Baseband > Custom Digital Modulation > Power Ramp Control > Source > Internal"
 - b) Select "Baseband > Custom Digital Modulation > Marker > Global Connector Setting".
Select "User 3 > Direction = Output", "User 3 > Signal = Lev Att A".

3.5.4.2 How to Create and Assign a Data List

The R&S SMBV100B provides the following ways to create a data list file:

- To use the dedicated [Data List Editor](#) and create a file with extension `*.dm_iqd`, see ["To create data lists manually"](#) on page 136
- To use the tag-oriented format and create a data list file, see ["To create a data list file using tag file format"](#) on page 769
- To use SCPI commands and create a file in binary format, see ["To create a data list in binary format"](#) on page 770

To create data lists manually

Use the intuitive build in [Data List Editor](#) dialog:

1. To access the "Data List Editor":
 - a) Select "Baseband > Custom Digital Mod > Data Source > Data List"
 - b) Select "Select Data List"
 - c) Navigate to the required directory, for example `/var/user/`.
Select "New" and enter "File Name" = `dl`.

The "Data List Editor" opens; the data list is empty.

2. Enter a sequence of 0 and 1, for example `01110101`.

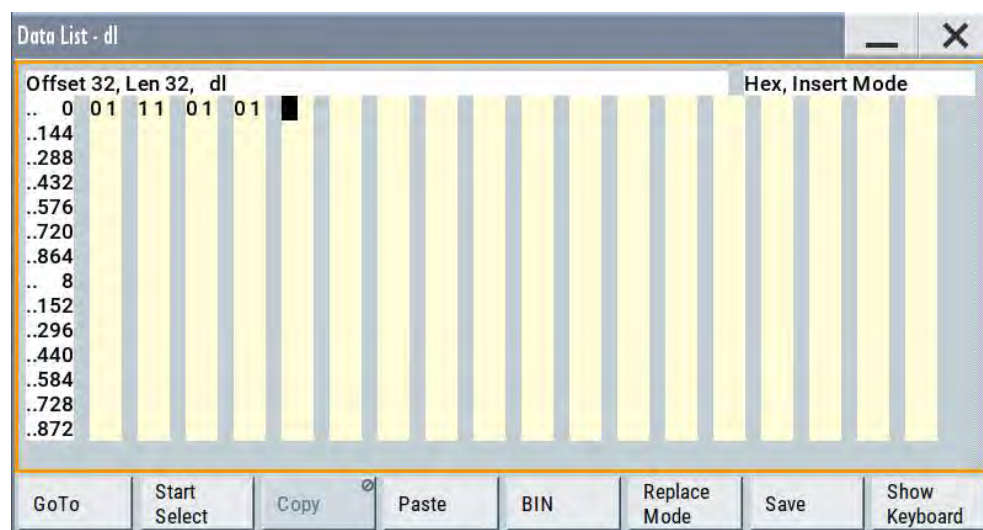

Figure 3-11: Example of data list

3. Select "Save" to store the used settings as a data list file.

The instrument stores the `dl.dm_iqd` file in the `/var/user/` directory.

How to assign and activate data lists

Irrespectively on the way they are created, generated data lists are not automatically used.

1. To enable the R&S SMBV100B to use the data list as data source for the custom digital modulation:
 - a) Select "Baseband > Custom Digital Modulation > Data Source > Data List"
 - b) Select "Select Data List"
 - c) Navigate through the file system. Select the file and confirm with "Select".
2. To enable the R&S SMBV100B to use the data list as data source for any of the digital standards:
 - a) Select the "Data List Name" in the individual dialog.
For example, for "Baseband > 3GPP FDD > Basestations > BS1 > Channel Table > P-CCPCH > Data = Data List"
 - b) Select "DList = None".
 - c) Select the file in the file system.

3.5.5 References

Table 3-5: Custom digital modulation default values

Parameter	Value
State	Not affected
Data Source	PRBS 9

Parameter	Value
Standard	GSM
Symbol Rate	270.833 ksymb/s
Coding	GSM
Modulation Type	MSK
Filter	Gauss (FSK)
Filter Parameter BxT	0.3
Trigger	Mode Auto, Source Internal
Clock	Source Internal
Power Ramp Control	
Attenuation	15 dB
Ramp Time	1 symbol
Ramp Function	Cosine
Fall Delay	0
Rise Delay	0
Source	Internal
State	Off

Table 3-6: Communication standards with their predefined settings

Standard	Modulation	Symbol Rate	Filter	Coding	Parameter for SCPI command
CW in Baseband	BPSK	1 MHz	Gauss, B*T = 0.5	Off	CWBPsk
APCO Phase1 C4FM	4FSK, Deviation 1.8 KHz	4.8 ksymb/s	APCO25, roll off = 0.2	APCO25(FSK)	APCOPH1C4fm
APCO Phase1 CQPSK	pi/4-DQPSK	4.8 ksymb/s	Cosine, roll off = 0.2, BW = 4.8 KHz	APCO25(PSK)	APCOPH1CQpsk
APCO Phase2 H-CPM	4FSK, Deviation 3 KHz	6 ksymb/s	APCO25 (H-CPM)	APCO25(FSK)	APCOPH2HCpm
APCO Phase2 H-DQPSK	pi/4-DQPSK	6 ksymb/s	Cosine, roll off = 1, BW = 7.2 KHz	APCO25(PSK)	APCOPH2HDQpsk
APCO Phase2 H-D8PSK Wide	pi/8-D8PSK	4 ksymb/s	Cosine, roll off = 1, BW = 7.2 KHz	APCO25(8PSK)	APCOPH2HD8PSKW
APCO Phase2 H-D8PSK Narrow	pi/8-D8PSK	4 ksymb/s	Cosine, roll off = 1, BW = 5 KHz	APCO25(8PSK)	APCOPH2HD8PSKN
APCO Phase1 LSM	pi/4-DQPSK	4.8 ksymb/s	APCO25 (LSM), Gauss Cut Off = 2.04 KHz, Low-pass Cut Off = 6.2 KHz	APCO25(PSK)	APCOPH1Lsm
APCO Phase1 WCQPSK	pi/4-DQPSK	4.8 ksymb/s	Cosine, roll off = 1, BW = 7.2 KHz	APCO25(PSK)	APCOPH1Wcqpsk

Standard	Modulation	Symbol Rate	Filter	Coding	Parameter for SCPI command
Bluetooth	2FSK, Deviation 160.0 kHz	1.0 Msym/s	Gauss, B*T = 0.5	OFF	BLUetooth
DECT	2FSK, Deviation 288.0 kHz	1.152 Msym/s	Gauss, B*T = 0.5	OFF	DECT
ETC (ARIB STD T55)	ASK, ASK Depth 100%	1.024 Msym/s	Split Phase, B*T = 2.0	OFF	ETC
GSM	MSK	270.833333 ksym/s	Gauss, B*T = 0.3	GSM	GSM
GSM EDGE	8PSK EDGE (3pi/8 8PSK)	270.833333 ksym/s	Gauss linear	OFF	GSMEdge
NADC	pi/4 DQPSK	24.3 ksym/s	Root cosine, alpha = 0.35	NADC	NADC
PDC	pi/4 DQPSK	21.0 ksym/s	Root cosine, alpha = 0.50	PDC	PDC
PHS	pi/4 DQPSK	192.0 ksym/s	Root cosine, alpha = 0.50	PHS	PHS
TETRA	pi/4 DQPSK	18.0 ksym/s	Root cosine, alpha = 0.35	TETRA	TETRa
WCDMA 3GPP	QPSK 45° Offset	3.84 Msym/s	Root cosine, alpha = 0.22	WCDMA 3GPP	W3GPP
TD-SCDMA	QPSK 45° Offset	1.28 Msym/s	Root cosine, alpha = 0.22	OFF	TCSCdma
cdma2000 Forward	QPSK	1.2288 Msym/s	cdmaOne + Equalizer	cdma2000	CFORward
cdma2000 Reverse	Offset QPSK	1.2288 Msym/s	cdmaOne	cdma2000	CREVerse
Worldspace	QPSK	1.84 Msym/s	Root cosine, alpha = 0.40	OFF	WORLdspace
TFTS	pi/4 DQPSK	22.1 ksym/s	Root cosine, alpha = 0.40	TFTS/ TETRA	TFTS

Table 3-7: Permissible coding combinations for modulation symbols and modulation type

	OFF	Differ- ential	Phase Diff.	Diff. +Gray	Gray	GSM	NADC, PDC, PHS, TETRA, APCO25 (PSK), PWT	TFTS/ TETRA	INMARSAT, ICO, WCDMA, cdma2000	VDL	APCO25 (FSK)	APCO25 (8PSK)
ASK	X	X		X	X							
BPSK	X	X		X	X							
pi/2 DBPSK	X				X							
QPSK	X	X		X	X				X			
QPSK EDGE	X											
QPSK45° Off- set	X	X		X	X							
Pi/4 QPSK	X	X			X							
Pi/4 DQPSK	X				X	X	X	X				
8PSK	X	X		X	X					X		

	OFF	Differ- ential	Phase Diff.	Diff. +Gray	Gray	GSM	NADC, PDC, PHS, TETRA, APCO25 (PSK), PWT	TFTS/ TETRA	INMARSAT, ICO, WCDMA, cdma2000	VDL	APCO25 (FSK)	APCO25 (8PSK)
AQPSK	X	X		X	X							
OQPSK	X	X		X	X							
8PSK_EDGE	X											
PI/8 D8PSK	X				X							X
MSK	X	X		X	X	X						
2FSK	X	X		X	X	X						
4FSK	X	X		X	X					X		
8FSK	X	X		X	X							
16FSK	X	X		X	X							
32FSK	X											
64FSK	X											
16QAM	X	X	X	X	X							
16QAM EDGE	X											
32QAM	X	X	X	X	X							
32QAM EDGE	X											
64QAM	X	X	X	X	X							
128QAM	X	X	X	X	X							
256QAM	X	X	X	X	X							
1024QAM	X	X	X	X	X							
16APSK	X											
32APSK	X											

3.5.5.1 Common Coding Algorithms



In the notation used below, a_n denotes the n^{th} input symbol and b_n denotes the correspondingly coded output symbol. Individual bits in the symbols from the LSB (least significant bit) to the MSB (most significant bit) are denoted by a_{0n} , a_{1n} , etc. The same applies to the output symbols.

Common coding types are listed in [Table 3-8](#).

Table 3-8: Common coding algorithms

Coding	Coding algorithm	Applicable for K bit/symbol	Required option
"None"	$b_n = a_n$	$k = 1...8$	-
"Differential"	$b_n = (a_n + b_{n-1}) \text{ modulo } 2^k$	$k = 1...7$	
"Differential + Gray"	Gray coding with additional differential coding	$k = 1...7$	
"GSM"	$d_n = \text{NOT} (d_n \text{ EXOR } d_{n-1})$	$k = 1$	R&S SMBVB-B10
"Phase differential coding" ¹⁾	$b_{1n} = [\text{NOT} (a_{1n} \text{ EXOR } a_{0n}) \text{ AND } (a_{1n} \text{ EXOR } b_{1(n-1)})] \text{ OR } [(a_{1n} \text{ EXOR } a_{0n}) \text{ AND } (a_{1n} \text{ EXOR } b_{0(n-1)})]$ $b_{0n} = [\text{NOT} (a_{0n} \text{ EXOR } a_{0n}) \text{ AND } (a_{0n} \text{ EXOR } b_{0(n-1)})] \text{ OR } [(a_{0n} \text{ EXOR } a_{0(n-1)}) \text{ AND } (a_{0n} \text{ EXOR } b_{1(n-1)})]$		R&S SMBVB-B10

¹⁾ "Phase differential coding" INMARSAT and PHASE DIFF correspond to system standards Inmarsat-M and DVB according to ETS 300 429. The INMARSAT coding can generally be used for modulation types with 2 bits/symbol, such as QPSK.

Examples

The following examples illustrate how some of the different common coding schemes combined with a modulation method influence the signal.

Example: Differential coding for QPSK modulation with K = 2 bit/symbol

Decimal display; the value range for modulation symbols is $a_n = \{0, 1, 2, 3\}$

According to Table 3-8 and for $k = 2$, the recursive coding is defined as $b_n = (a_n + b_{n-1}) \text{ modulo } 4$

Depending on the state of a preceding modulation symbol b_{n-1} , the coded modulation symbol b_n is obtained, for example, from modulation symbol $a_n = 2$ as follows:

b_{n-1}	0	1	2	3
b_n	2	3	0	1

With differential coding, the assignment of modulation symbols a_n (binary indication: MSB, LSB) to the phase differences shown in the following table is generated:

Table 3-9: Phase difference for QPSK

Modulation symbol a_n	00	01	10	11
Phase difference	0°	90°	180°	270°

Example: Differential coding for modulation type pi/4DQPSK

With differential coding switched on at the same time, the obtained constellation diagram for pi/4DQPSK is similar to that of 8PSK. Phase shifts are however assigned to the individual modulation symbols. The Table 3-10 shows the assignment of modulation symbols a_n (binary indication: MSB, LSB) to phase shifts of the I/Q vector in relation to the selected coding.

Table 3-10: Phase shifts for pi/4DQPSK

Modulation symbol a_n	00	01	10	11
"Coding = OFF"	+ 45°	+ 135°	- 135°	- 45°
"Coding = NADC, PDC, PHS, TETRA, or APCO25 (PSK)"	+ 45°	+ 135°	- 45°	- 135°
"Coding = TFTS"	- 135°	+ 135°	- 45°	+ 45°

Example: Gray and differential coding for 8PSK modulation

When this coding scheme is used, the gray coding according to the gray code is performed before the differential coding. The later uses the recursive coding algorithm quoted above (see Table 3-8). The assignment of modulation symbols a_n (binary indication: MSB, LSB) to the phase differences shown in the following table is generated:

Table 3-11: Differential coding according to VDL¹⁾

Modulation symbol d_n	000	001	010	011	100	101	110	111
Phase difference	0°	45°	135°	90°	270°	315°	225°	180°

¹⁾ "Differential coding according to VDL" can be used for modulation types with 3 bits/symbol, e.g. 8PSK.

3.5.5.2 Predefined Baseband Filters

The Table 3-12 shows the filters that are available, together with their associated parameters. The filter characteristic is displayed in graphical form.

**Filter names Cosine and Root Cosine**

The filter names "Cosine" and "Root Cosine" are used for backwards compatibility with former Rohde & Schwarz signal generators.

These names do not correspond to the underlying transfer functions the filters use:

- "Cosine" filters use **raised cosine** transfer function.
- "Root Cosine" filters use **root raised cosine (RRC)** transfer function.

Table 3-12: Overview of the baseband filters

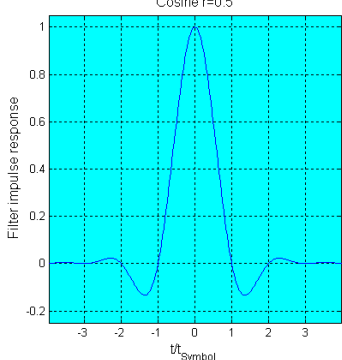
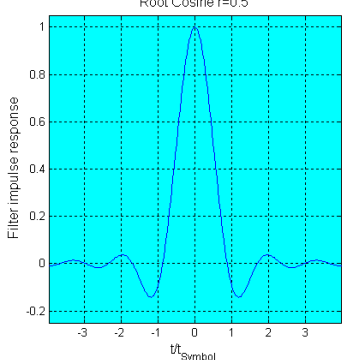
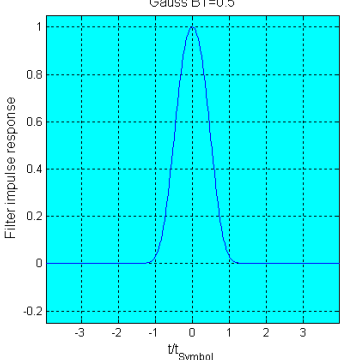
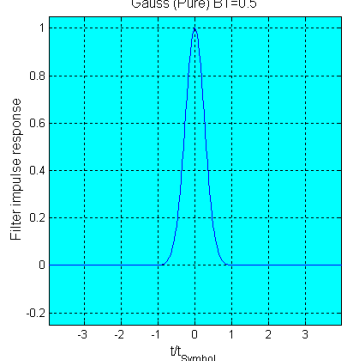
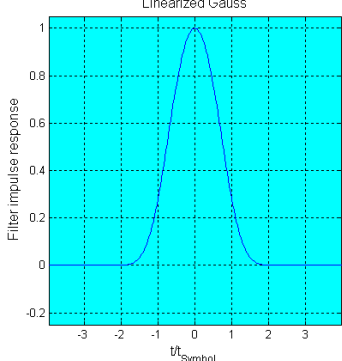
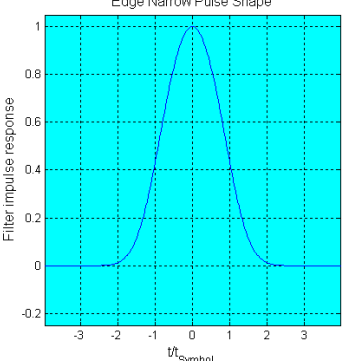
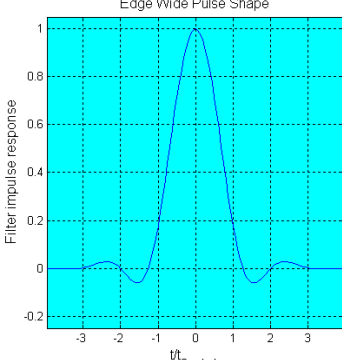
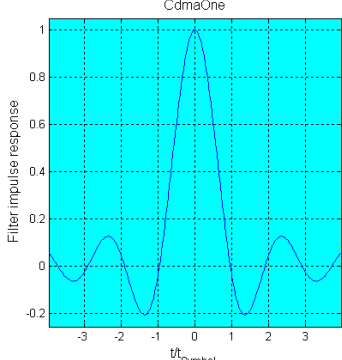
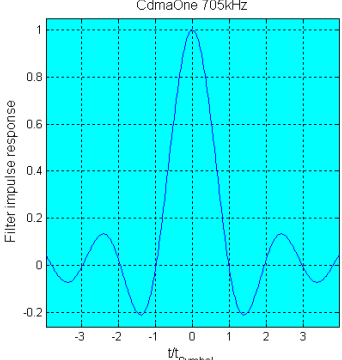
<p>Cosine (raised cosine) Rolloff factor Bandwidth</p>	<p>Root cosine (root raised cosine (RRC)) Rolloff factor</p>	<p>Gauss (FSK) BxT</p>
		
<p>Pure gauss BxT</p>	<p>Gauss linearized</p>	<p>Edge narrow pulse shape</p>
		
<p>Edge wide pulse shape</p>	<p>cdmaOne</p>	<p>cdmaOne 705 kHz</p>
		
<p>cdmaOne + Equalizer</p>	<p>cdmaOne 705 kHz + Equalizer</p>	<p>cdma2000 3X</p>

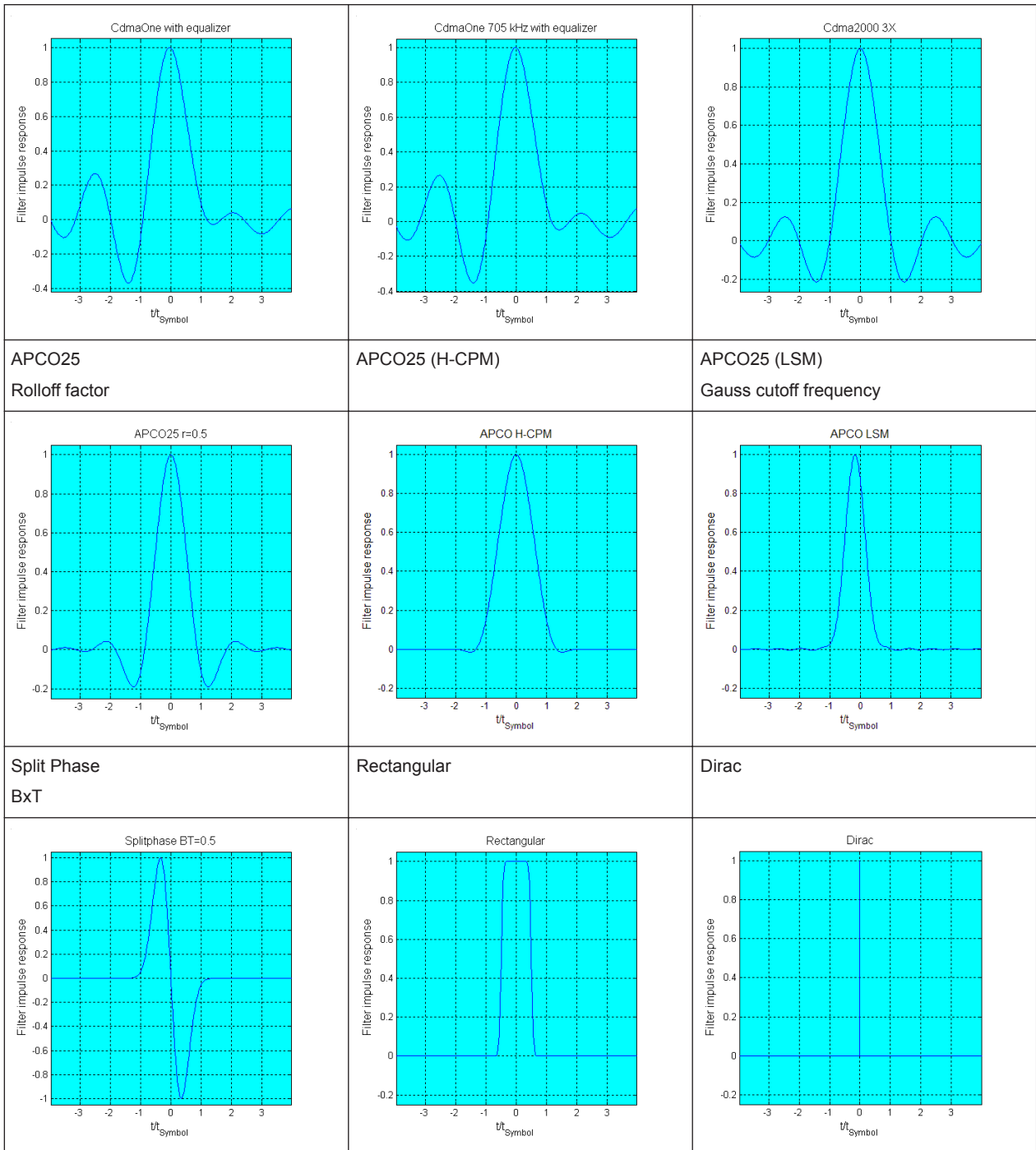

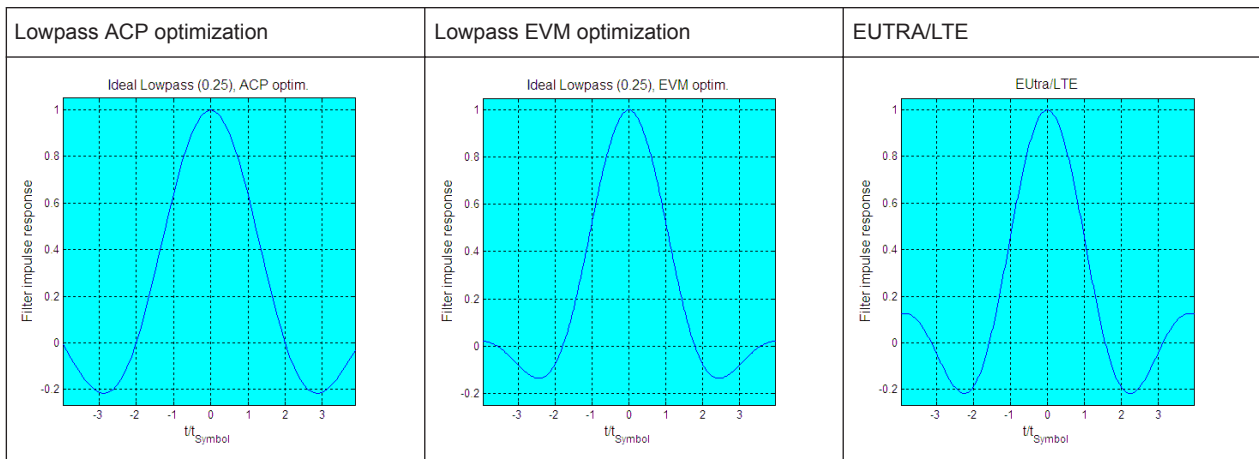

3.6 Using the Arbitrary Waveform Generator (ARB)

The Arbitrary Waveform Generator (ARB) is an I/Q modulation source forming part of the R&S SMBV100B. The ARB allows the playback and output of any externally calculated modulation signals in the form of waveform files. The ARB can also generate multi-carrier or multi-segment signals from the waveform files.

3.6.1 Required Options

The equipment layout for processing of waveform files includes:

- Base unit, incl. arbitrary waveform generator
- Corresponding digital standard option (R&S SMBVB-K2xx/K4xx)
Required to process a waveform file generated by the signal generation software R&S WinIQSIM2.
For example, if you purchase option Digital Standard EUTRA/LTE R&S SMBVB-K255, you can process EUTRA/LTE waveform files generated by R&S WinIQSIM2.
- Corresponding R&S®Pulse Sequencer option
- Optional, ARB memory extension (R&S SMBVB-K511/-K512/-K513)

Depending on the connectors at that the waveform is output, the following options are required:

- Output at the RF connector requires suitable RF frequency option (R&S SMBVB-B103/KB106)

3.6.2 About the ARB

This section provides background information on the ARB functionality and the impact of the provided settings.

For a description of the multi-carrier, multi-segment and multi-carrier continuous wave functions, refer to:

- [Chapter 3.8, "Generating Multi-Carrier Signals"](#), on page 197
- [Chapter 3.7, "Generating Multi-Segment Waveform Files"](#), on page 167
- [Chapter 3.9, "Generating Multi-Carrier Continuous Wave Signal"](#), on page 215

3.6.2.1 Waveform Files Sources

In ARB mode, the R&S SMBV100B uses ARB waveform files to obtain the digital I/Q data of the baseband signal. The R&S SMBV100B can replay any waveform file stored on a network drive but it can also generate and replay simple waveforms for test purposes.

A waveform is a file with specified file format containing raw IQ samples. The IQ values are calculated in advance and stored as waveform files with a predefined extension * .wv. When created by the R&S SMBV100B, the instrument inserts a tagged waveform header at the beginning of each created ARB file. For more information, refer to [Chapter 12.16.4.4, "Waveform, Data and List Format"](#), on page 750.

Depending on whether the R&S SMBV100B creates the waveform files itself or not, two waveform files sources can be distinguished:

- **Internally generated waveforms**
The ARB generator enables the calculation and the generation of multi-segment and multi-carrier waveform files. The ARB generator provides also a built-in function to create a test waveform (e.g. a sine or rectangle signal) and keep it as a file or in the RAM.
Several digital standards provide the special function "Generate Waveform File". With this function, the calculated signals are stored as a waveform file that can be afterwards played by the ARB generator.
- **Externally generated waveforms**
The ARB can also process externally generated waveform files. For example, the waveform files generated by the software R&S WinIQSIM2, the R&S ARB Toolbox, the R&S Pulse Sequencer or signals calculated using a mathematical program such as MATLAB.
The externally generated waveform files can be loaded into the instrument via one of the available interfaces (USB, LAN or GPIB). Usually, the waveform file is stored on one of the network drives which are accessible for the operating system.

3.6.2.2 ARB Test Signals

The following test signals are available:

- **Sine Test Signal:** Two sinewave signals with a selectable (but equal) number of samples per period and equal frequencies. When the generation is triggered, the number of samples per period, together with the frequency of the test signal, determines the ARB clock frequency: "Clock Frequency" = "Frequency" * "Samples per Period".

Note: Because the resulting clock rate must not exceed the maximum ARB clock rate (see data sheet), the number of sample values is automatically restricted depending on the selected frequency.

The first sine signal is mapped on the I samples, the second on the Q samples.

The two signals differ by a selectable phase offset. For a -90 deg offset, the result is a unit vector in the I/Q plane, rotating counter-clockwise and starting at $I = 0, Q = -1$. For a 0 deg offset, the I and Q samples are on the diagonal of a unit square ($I(t) = Q(t)$).

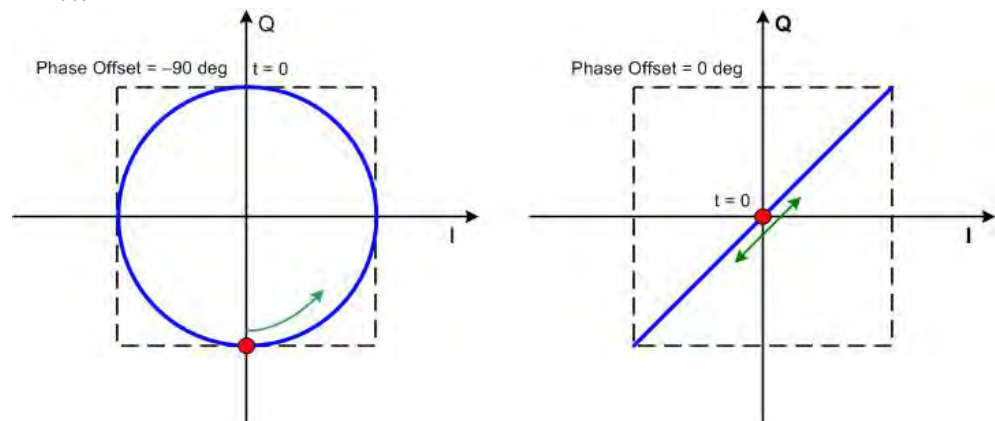

In general the I/Q samples are located on a deformed circle which is confined to the dashed square in the upper diagrams.

- **Rect Test Signal:** Rectangle signal with selectable but equal On and Off periods and amplitude. The period is defined by the selected frequency: $\langle \text{Period} \rangle = 1 / \text{"Frequency"}$.

The signal is mapped on both the I and Q samples. This results in two distinct points in the I/Q plane. The "Offset DC" shifts both points along the diagonal $I(t) = Q(t)$.

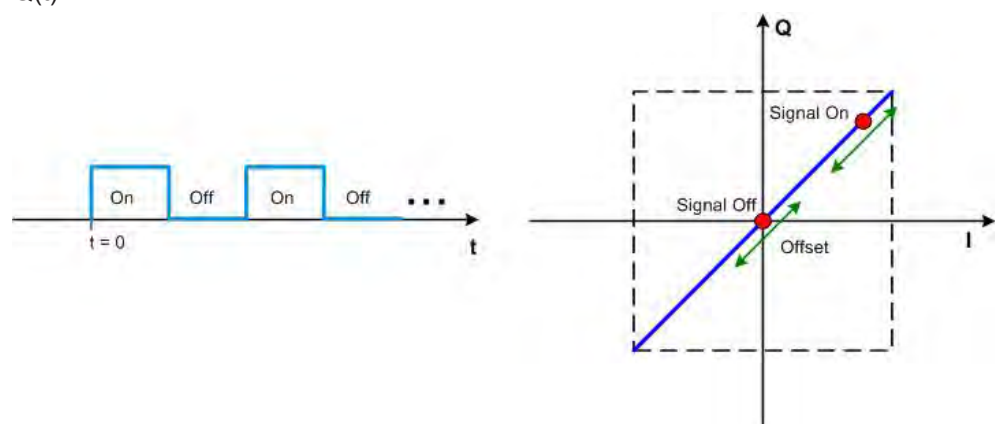

- **Const I/Q Test Signal:** Continuous test signal with constant IQ and constant Clock Frequency of 10 KHz. The values for each I and Q components are selectable but constant. They are defined as a decimal number, which is decimal-to-binary converted internally. The signal is provided as a 16-bit wide digital signal for both I and Q channels.

Converted to analog, the signal is output directly at the BNC connectors I and Q outputs of the instrument.

3.6.2.3 Waveform Sample Rate

The Arbitrary Waveform Generator includes a resampling unit that interpolates the input samples to reach a target digital output I/Q sample rate before digital-to-analog conversion (DAC). The input sample rate f_{input} is retrieved from the waveform (the default sample rate tag) or is defined by the corresponding parameter in the ARB user interface.

The Figure 3-12 depicts the stages involved in the processing and resampling of a waveform in the ARB.

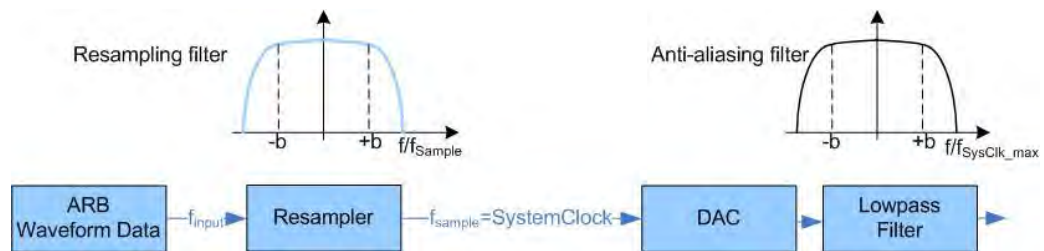

Figure 3-12: Processing of the waveform files in the ARB

f_{input} = Waveform sample rate
 b = Usable bandwidth factor
 $f_{SysClk_max} = SystemClock_{max} = SampleRate_{max}$

Where:

- $f_{SysClk_max} = SystemClock_{max} = SampleRate_{max} = 600$ MHz
- $b = 0.4165$

Impact of the Resampling Filter

As illustrated in Figure 3-12, the filter in the resampling stage is distortion-free for signals with the following maximum baseband bandwidth:

$$Usable_Bandwidth_{max} [MHz] = b * f_{input}$$

Where b is the usable bandwidth factor and $b = 0.4165$.

An externally created waveform file has to provide a sample rate f_{input} that is high enough for perfect signal reconstruction. For distortion-free resampling the lower bound of the required sample rate f_{input} is then calculated as follows:

$$f_{input} \geq Usable_Bandwidth / b$$

Thus, a modulation signal with a sample rate $f_{input} = 600$ MHz fed in the baseband generator ensures the $Usable_Bandwidth_{max}$. After the DAC, this signal features a $RF_Bandwidth_{max} = 2 * b * f_{input} = 2 * b * 600$ MHz = 500 MHz.

Impact of the Oversampling Factor

Waveforms generated by the R&S WinIQSIM2 software can be optimized by choosing a suitable integer oversampling factor.

Conventional ARB generators often assume oversampling factors of 4. The ARB generator of the R&S SMBV100B requires low oversampling factors and still provides excellent signal quality in terms of EVM and ACP.

A reduced sample rate saves significantly the amount of memory or allows an increased signal cycle time, and vice versa.

3.6.2.4 Impact of the Enabled Number of Marker Signals on the Waveform Length

The R&S SMBV100B provides the possibility to define marker signals, that are sent to the marker outputs in synchronicity with the I/Q output signals. Marker signals can be either predefined or subsequently defined.

The I/Q data and marker data are located in separate memory areas of the SDRAM and can be independently configured. Each marker signal requires 1 bit of the available memory size. Sometimes, it is useful to generate a modulation signal without extra marker signals to increase the maximum waveform length.

The following example explains the dependency between the number of enabled marker signals, the available memory size, and the resulting waveform length.

Example: Calculating the maximum waveform length

The calculation in this example assumes R&S SMBV100B equipped with option R&S SMBVB-K511 (256 Msamples).

- Total Memory Size = 256 MB
- Required Memory Size (per complex sample) = 32 bits + 3 bits = 35 bits = 4.375 bytes, where:
 - The raw I/Q samples are stored as 16-bit values;
That is, for I/Q data = 2 x 16 bits = 32 bits (16 bits per I/Q channel)
 - Each software defined marker requires 1 bit;
That is, for 3 enabled markers = 3 x 1 bit = 3 bits
- Maximum Waveform Length (with 3 markers) = 256 MB / 4.375 bytes = 58 Msamples
- Theoretical Maximum Waveform Length (no markers) = 256 MB / 4 bytes = 64 Msamples

Hence, a memory size of 256 MB yields a maximum waveform length of 58 Msamples if three markers are enabled. The maximum waveform length increases to 64 Msamples, if the internal hardware markers are used, and the complete memory is available for I/Q data.

The minimum length of a waveform is 512 samples. A waveform shorter than this value is automatically repeated until it reaches the minimum length.

3.6.3 ARB Settings

Access:

- ▶ Select "Baseband > ARB".

The "ARB" dialog enables direct selection of the waveform file to be processed, the selection of a test signal or access to the multi-segment and multi-carrier settings.

The remote commands required to define these settings are described in [Chapter 12.16.4.3, "SOURce:BB:ARbitrary Subsystem"](#), on page 707.

Settings:

- [ARB General Settings](#)..... 150
- [Sine Test Signals](#)..... 154
- [Rectangular Test Signal](#)..... 155
- [Constant IQ Test Signal](#)..... 157
- [Trigger, Marker and Clock Setting](#)..... 158

3.6.3.1 ARB General Settings

Access:

- ▶ Select "Baseband > ARB".

This tab provides access to the default ARB settings, selecting a waveform file and enabling the ARB generator.

Further settings depend on selected "System Configuration" and waveform type:

- If a single segment waveform is used, the tab provides also settings for configuring the test signal and access to the settings for calculating a multi-segment or a multi-carrier waveform.
- If a multi-segment waveform is loaded, the tab expands and displays the dedicated section "Multi Segment Waveform Options".

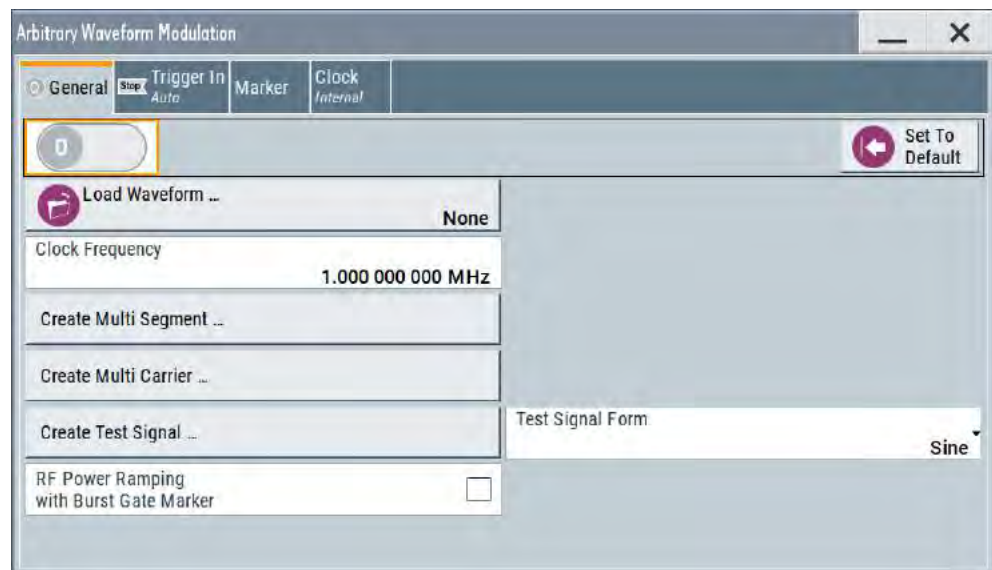

This section comprises the settings necessary to configure the segment to be output and adjust the trigger for the switch between the segments of the multi-segment waveform. The parameters displayed depend on the selected trigger source. The provided parameters are identical with the parameters in the section "Next Segment Trigger In" in the "Trigger" tab; for information see [Chapter 3.7.3.5, "Next Segment Trigger In Settings"](#), on page 186.

Settings:

State.....	151
Set To Default.....	152
Load Waveform/File.....	152
Waveform Info.....	152
Clock Frequency.....	153
Create Multi Segment.....	153
Create Multi Carrier.....	153
Create Test Signal.....	153
Test Signal Form.....	153
RF Power Ramping with Burst Marker.....	154

State

Enables/disables ARB modulation. Switching on the ARB generator turns off all the other digital standards and digital modulation types in the same signal path.

The output is based on the waveform file that is loaded. The name of the waveform file is displayed next to "Load Waveform". When a multi-segment waveform is loaded, the display expands and lists more settings, grouped in the "Multi Segment Waveform Options" section.

Note: ARB generator cannot be activated.

You cannot activate the ARB generator in the following cases:

- **No or empty waveform file**

If no waveform file is loaded, as in the default state, "None" is displayed next to "Load Waveform". An error message indicates that no or empty waveform file is selected.

Select a waveform file, before switching on the ARB.

- **Missing burst gate marker in the waveform** but "RF Power Ramping with Burst Gate Marker > On"
If "RF Power Ramping with Burst Gate Marker > On" but the loaded ARB waveform does not contain control list or the burst gate marker is not defined, the ARB generator cannot be activated.
An error message indicates this situation, too.

Remote command:

[\[:SOURce<hw>\]:BB:ARbitrary:STATe](#) on page 716

Set To Default

Calls default settings (see [Table 3-13](#)).

Table 3-13: ARB Default Settings

Parameter	Value
State	Off
Clock Freq.	1 MHz
Trigger Mode	Auto
Trigger Source	Internal
Marker State	Off
Marker Mode	Unchanged
Clock Source	Internal

Remote command:

[\[:SOURce<hw>\]:BB:ARbitrary:PRESet](#) on page 716

Load Waveform/File

Accesses the standard "File Select" function of the instrument. The provided navigation possibilities in the dialog are self-explanatory.

The waveform files are files with predefined file extension *.wv. When a file is selected, the dialog displays short information about the selected waveform.

Enable the ARB generator ("ARB > State > On") to trigger the instrument to load and process the selected waveform file.

Remote command:

[\[:SOURce<hw>\]:BB:ARbitrary:WAVeform:SElect](#) on page 721

Waveform Info

Opens a dialog with detailed information about the currently selected waveform. The display depends on whether the selected waveform file is a multi-segment one or not. All parameters are read-only.



Remote command:

For non-multi segment waveform files, use the `Tag` commands (see [Chapter 12.16.4.4, "Waveform, Data and List Format"](#), on page 750).

Clock Frequency

Displays or sets the ARB output clock rate.

The value of this parameter is set to the clock rate defined in the loaded waveform file (`{CLOCK}` tag). The value can be changed afterwards.

Note: The clock frequency must match the value of the externally applied clock source.

Remote command:

`[:SOURce<hw>] :BB:ARbitrary:CLOCK` on page 723

Create Multi Segment

Accesses the dialog for creating multi-segment waveforms (see [Chapter 3.7, "Generating Multi-Segment Waveform Files"](#), on page 167).

Create Multi Carrier

Accesses the dialog for creating multi-carrier waveforms (see [Chapter 3.8, "Generating Multi-Carrier Signals"](#), on page 197).

Create Test Signal...

Opens the dialog with further setting for the selected [Test Signal Form](#), see:

- [Chapter 3.6.3.2, "Sine Test Signals"](#), on page 154
- [Chapter 3.6.3.3, "Rectangular Test Signal"](#), on page 155
- [Chapter 3.6.3.4, "Constant IQ Test Signal"](#), on page 157

Test Signal Form

Selects the form of the test signal. A choice between a sinusoidal, rectangular, or test signal with constant I/Q is provided.

To access further settings, select [Create Test Signal...](#)

Remote command:

`[:SOURce<hw>] :BB:ARBitary:SIGnal:TYPE` on page 717

RF Power Ramping with Burst Marker

Option: R&S SMBVB-K22

If activated, the burst gate marker signal included in the ARB waveform file is used as marker signal for the pulse modulator.

If this parameter is activated, but the loaded ARB waveform does not contain control list or the burst gate marker is not defined, the ARB generator cannot be activated. An error message indicates this situation, too.

You can create the suitable waveform files including the required burst gate marker signals, for example, with the R&S Pulse Sequencer software.

Remote command:

`[:SOURce<hw>] :BB:ARBitary:PRAMP [:STATe]` on page 716

3.6.3.2 Sine Test Signals

Access:

- ▶ Select "Baseband > ARB > General > Create Test Signal > Sine" and press "Create Test Signal".

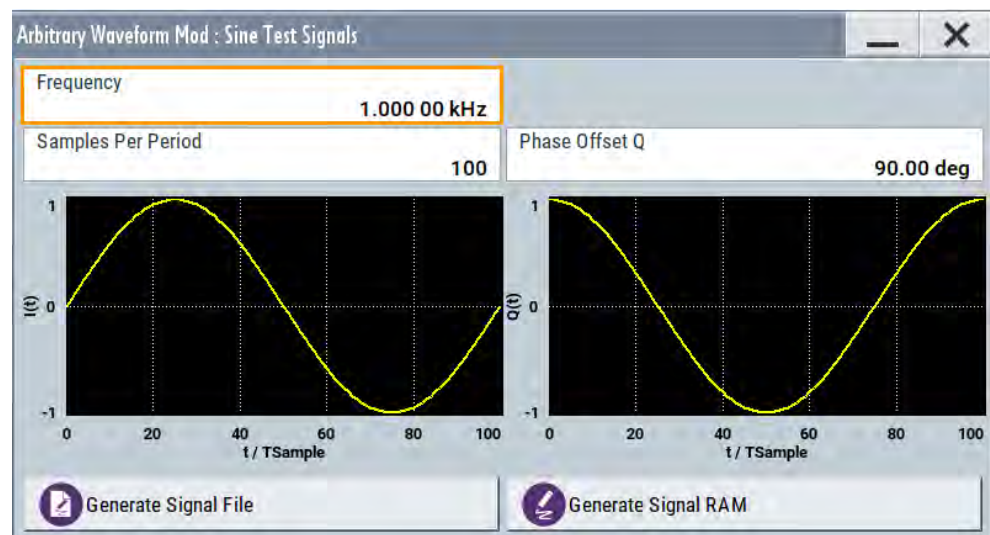

This dialog provides settings for configuration of a sinusoidal test signal. A sine wave is generated on the I path, and a sine wave of the same frequency but phase-shifted is generated on the Q path. For more information, refer to [Chapter 3.6.2.2, "ARB Test Signals"](#), on page 146.

The dialog displays the characteristic of the currently selected signal.

Settings:

Frequency.....	155
Samples per Period.....	155
Phase Offset Q.....	155
Generate Signal File.....	155
Generate Signal RAM.....	155

Frequency

Enters the frequency of the test signal.

Remote command:

`[:SOURce<hw>] :BB:ARbitrary:TSIGnal:SINE:FREQuency` on page 719

Samples per Period

Enters the number of sample values required from the sine wave per period.

The maximum allowed value is determined by the maximum ARB clock rate (see data sheet) and the selected frequency.

Remote command:

`[:SOURce<hw>] :BB:ARbitrary:TSIGnal:SINE:SAMPles` on page 719

Phase Offset Q

Enters the phase offset of the sine-wave signal on the Q channel relative to the sine-wave signal on the I channel.

Remote command:

`[:SOURce<hw>] :BB:ARbitrary:TSIGnal:SINE:PHASe` on page 719

Generate Signal File

Generates a signal and saves it as a waveform file on the hard disk. Use the standard "File Select" function to store this file.

Remote command:

`[:SOURce<hw>] :BB:ARbitrary:TSIGnal:SINE:CREate:NAMed` on page 720

Generate Signal RAM

Generates a signal and uses it as output straight away. The instrument stores the file with a predefined name.

Remote command:

`[:SOURce<hw>] :BB:ARbitrary:TSIGnal:SINE:CREate` on page 720

3.6.3.3 Rectangular Test Signal

Access:

1. Select "Baseband > ARB > General > Create Test Signal > Rect".

2. Select "Create Test Signal".

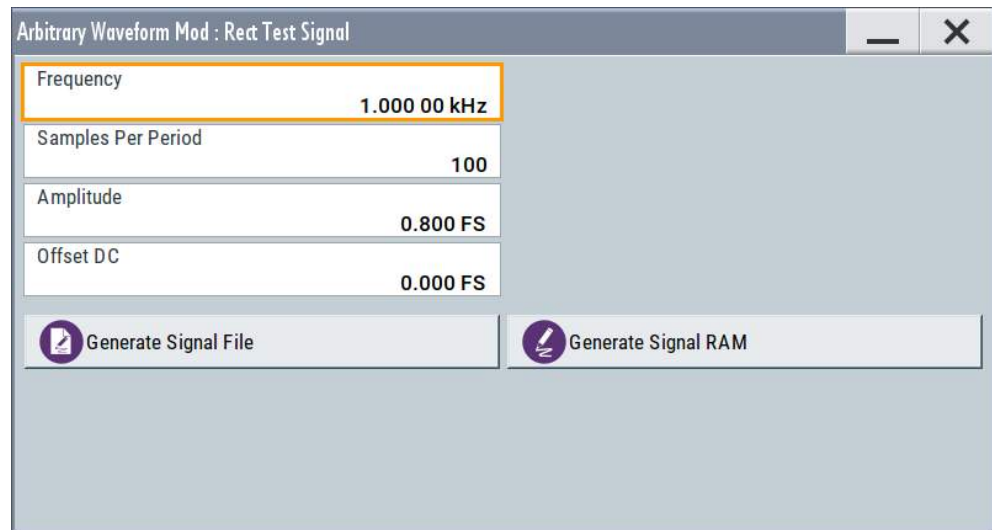

This dialog provides settings for configuration of a rectangular test signal. A rectangular test signal with a duty factor of 0.5 is created. Amplitude and offset are adjustable. Both paths, I and Q, use the same signal.

For more information, refer to [Chapter 3.6.2.2, "ARB Test Signals"](#), on page 146.

Settings:

Frequency.....	156
Samples per Period.....	156
Amplitude.....	156
Offset DC.....	157
Generate Signal File.....	157
Generate Signal RAM.....	157

Frequency

Enters the frequency of the test signal.

Remote command:

`[:SOURce<hw>] :BB:ARbitrary:TSIGnal:RECTangle:FREQuency` on page 718

Samples per Period

Enters the number of sample values required for the rectangular signal per period.

The maximum allowed value is determined by the maximum ARB clock rate (see data sheet) and the selected frequency.

Remote command:

`[:SOURce<hw>] :BB:ARbitrary:TSIGnal:RECTangle:SAMPles` on page 718

Amplitude

Enters the digital amplitude of the rectangular wave. The abbreviation FS means full scale.

Remote command:

`[:SOURce<hw>] :BB:ARbitrary:TSIGnal:RECTangle:AMPLitude` on page 717

Offset DC

Enters a DC component.

Remote command:

[\[:SOURce<hw>\]:BB:ARbitrary:TSIGnal:RECTangle:OFFSet](#) on page 718

Generate Signal File

Generates a signal and saves it as a waveform file on the hard disk. Use the standard "File Select" function to store this file.

Remote command:

[\[:SOURce<hw>\]:BB:ARbitrary:TSIGnal:RECTangle:CREate:NAMed](#)
on page 720

Generate Signal RAM

Generates a signal and uses it as output straight away. The instrument stores the file with a predefined name.

Remote command:

[\[:SOURce<hw>\]:BB:ARbitrary:TSIGnal:SINE:CREate](#) on page 720

3.6.3.4 Constant IQ Test Signal

Access:

1. Select "Baseband > ARB > General > Create Test Signal > Const IQ".
2. Select "Create Test Signal".

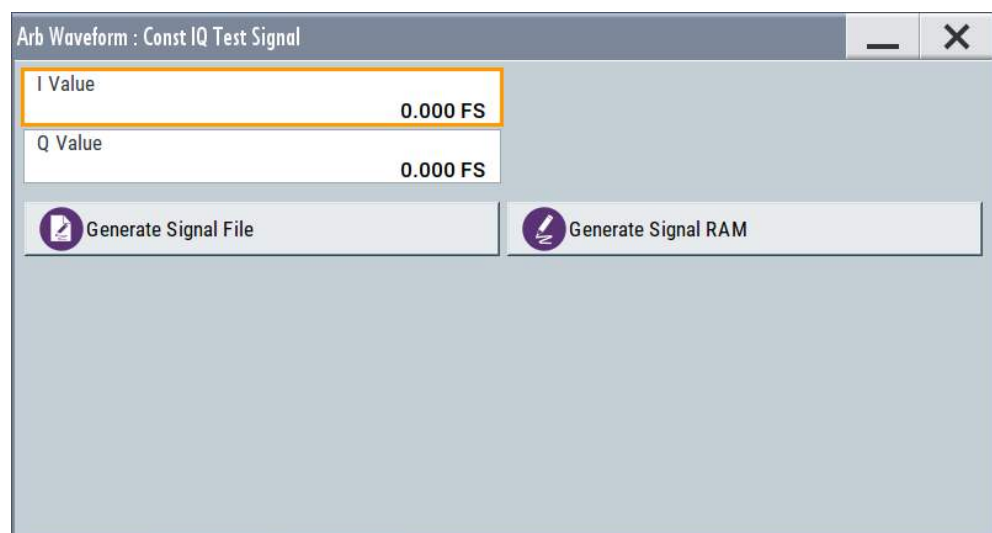

This dialog provides settings for configuration of a continuous test signal with constant IQ. The I and Q values for each path are adjustable but constant. For more information, refer to [Chapter 3.6.2.2, "ARB Test Signals"](#), on page 146. Converted to analog, the signal is output directly at the I and Q connectors of the instrument.

Settings:

I Value, Q Value.....	158
Generate Signal File.....	158
Generate Signal RAM.....	158

I Value, Q Value

Enters the value for the I respectively Q component of the test signal.

Remote command:

`[:SOURce<hw>] :BB:ARbitrary:TSIGnal:CIQ:I` on page 717

`[:SOURce<hw>] :BB:ARbitrary:TSIGnal:CIQ:Q` on page 717

Generate Signal File

Generates a signal and saves it as a waveform file on the hard disk. Use the standard "File Select" function to store this file

Remote command:

`[:SOURce<hw>] :BB:ARbitrary:TSIGnal:CIQ:CREate:NAMed` on page 720

Generate Signal RAM

Generates a signal and uses it as output straight away. The instrument stores the file with a predefined name.

Remote command:

`[:SOURce<hw>] :BB:ARbitrary:TSIGnal:CIQ:CREate` on page 720

3.6.3.5 Trigger, Marker and Clock Setting

These tabs provide standard settings.

For detailed description, see:

- [Chapter 3.4.2.1, "Trigger Settings"](#), on page 110
- [Chapter 3.4.2.2, "Marker Settings"](#), on page 113
- [Chapter 3.4.2.3, "Clock Settings"](#), on page 115
- [Chapter 3.4.2.4, "Global Connector Settings"](#), on page 115

The following settings are specific to the ARB dialog.

Marker Mode

Basic marker configuration for up to three marker channels. The contents of the dialog change with the selected marker mode.

Use the settings to define the shape and periodicity of the markers. See [Regular Marker Output Signals](#) for description of the regular marker signals.

Note: The marker trace in the waveform file remains unchanged in any case. It is not overwritten, even if something else than Unchanged has been selected.

The instrument routes the generated marker signals to the selected output connectors.

See [Chapter 10.2, "Configuring the Global Connectors"](#), on page 486.

"Unchanged" The marker signal remains unchanged as defined in the waveform file.

Remote command:

[:SOURce<hw>] :BB:ARBitrary:TRIGger:OUTPut<ch>:MODE on page 748

[:SOURce<hw>] :BB:ARBitrary:TRIGger:OUTPut<ch>:PULSe:DIVider

on page 749

[:SOURce<hw>] :BB:ARBitrary:TRIGger:OUTPut<ch>:PULSe:FREQuency?

on page 749

[:SOURce<hw>] :BB:ARBitrary:TRIGger:OUTPut<ch>:PATtern on page 748

[:SOURce<hw>] :BB:ARBitrary:TRIGger:OUTPut<ch>:OFFTime on page 748

[:SOURce<hw>] :BB:ARBitrary:TRIGger:OUTPut<ch>:ONTime on page 748

3.6.4 How to Generate and Play Waveform Files

This section provides step-by-step instructions on configuring and using the provided settings. For details on individual functions and settings, see [Chapter 3.6.3, "ARB Settings"](#), on page 150.

Some test cases do not require a real time generation of signal according to a digital standard. For these test cases, the replay of a previously generated waveform is sufficient. In such cases, you can generate the required test waveform file in one of the following ways:

- Internally,
 - With the built-in "Generate Waveform File" function, see [Chapter 3.6.4.2, "How to Create Waveform Files with the Built-In Generate Waveform File Function"](#), on page 160
 - With the "Create ARB Test Signal" function, see [Chapter 3.6.4.1, "How to Create and Store ARB Test Signals"](#), on page 159
- Externally, for example:
 - With the free of charge software R&S WinIQSIM2, see [Chapter 3.6.4.4, "How to Create a Waveform File with the R&S WinIQSIM2 and Load it in the ARB"](#), on page 161
 - With the software R&S ARB Toolbox
 - With the R&S SMBVB-K300/-K301 Pulse Sequencer software
 - Calculated using a mathematical program such as MATLAB, see ["How to Manually Create a Waveform Using Tag File Format"](#) on page 763.

Provided the R&S SMBV100B is equipped with the required option, you can load this waveform file and subsequent process it with the instrument.

This section provides examples on the internal waveform file generation and on the external generation with the R&S WinIQSIM2.

3.6.4.1 How to Create and Store ARB Test Signals

If your test case requires a simple sine or square test file, consider to use the provided ARB test signals.

1. Select "Baseband > ARB"

2. Select "Create Test Signal > Sine".
3. Adjust the "Sine Test Signal" settings as required.
4. Select "Generate Signal File".
Navigate through the directory tree (e.g. `/var/user/`).
Enter a filename (e.g. `sine_waveform`).
Select "Save".

The R&S SMBV100B stores the generated waveform file and automatically loads it in the ARB.
5. Select "ARB > State > On".

The R&S SMBV100B processes the waveform file.

3.6.4.2 How to Create Waveform Files with the Built-In Generate Waveform File Function

Several digital standards provide the special function "Generate Waveform File". This function enables the calculation and storage of the signal as a waveform file that can be afterwards played by the ARB generator.

To generate an EUTRA/LTE waveform file

1. Select "Baseband > EUTRA/LTE/IoT..."
2. Adjust the settings as required, for example:
 - a) select "Link Direction > Downlink"
 - b) select a predefined test model, "Test Setups/Models > E-TM1_1__10MHz"
3. Enable "EUTRA/LTE/IoT > State > On".
4. Select "Generate Waveform File".
Navigate through the directory tree (e.g. `/var/user/`).
Enter a filename (e.g. `lte_waveform`).
Select "Save"

The R&S SMBV100B stores the generated waveform file `lte_waveform.wv` under the selected directory `/var/user/`.

To process the waveform file, load it in the ARB (see [Chapter 3.6.4.3, "How to Load and Play Waveform Files"](#), on page 160).

3.6.4.3 How to Load and Play Waveform Files

Irrespectively on the way a waveform file is generated, you can transfer it on the instrument, load it in the ARB and play it.

To load and play a waveform file

1. Transfer an externally created waveform file to the instrument.
See [Chapter 9.9, "How to Transfer Files from and to the Instrument"](#), on page 468
2. Select "Baseband > ARB"

3. Select "Load Waveform File".
Navigate to the directory with the stored file.
Select the waveform file (e.g. `/var/user/lte_waveform`).
Press "Select".
The "ARB" dialog confirms that the waveform file is loaded.
4. Select "ARB > State > On".
The R&S SMBV100B processes the waveform file.

3.6.4.4 How to Create a Waveform File with the R&S WinIQSIM2 and Load it in the ARB

The following is an example on how to use the R&S WinIQSIM2 to generate an EUTRA/LTE waveform and load it in the ARB of the R&S SMBV100B.

The workflow consists of three main steps, each described in a separate step-by-step instruction:

- Configuring the connection between the R&S WinIQSIM2 and the R&S SMBV100B
- Generating of a waveform file with the required settings
- Transferring the waveform file to and paying it with the R&S SMBV100B.



This section does not describe the R&S WinIQSIM2 but focuses only the task-related settings.

For more information on configuration and working with the R&S WinIQSIM2, refer to description "R&S WinIQSIM2 User Manual".

To configure the R&S SMBV100B as destination instrument in the R&S WinIQSIM2

In this example, we assume that the R&S WinIQSIM2 is installed on a remote controller. This remote controller is connected over LAN to the R&S SMBV100B.

The general instrument settings of the destination instrument affect various functions, like, the maximum size of the file the waveform is stored in. We recommend that you configure the destination instrument before you generate the waveform with the R&S WinIQSIM2.

1. In the R&S WinIQSIM2, select "File > New" to preset the software to a defined state.
2. In the block diagram, select "Vector Sig Gen > Instruments".
The "Configure Instruments" dialog opens. The list of configured instruments is empty.
3. Select "Configure Instruments > Scan".
The software scans the network for connected and active instruments.

Using the Arbitrary Waveform Generator (ARB)



Alternatively, use the "New" function to add the R&S SMBV100B manually to the list of instruments.

4. Close the dialog.
5. In the block diagram, select "Vector Sig Gen" block and select the R&S SMBV100B form the list.

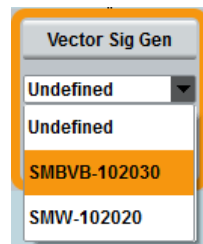

6. In the block diagram, select "ARB Sig Gen" block and select the R&S SMBV100B form the list.

The two lines to the "Vector Sig Gen" and "ARB Sig Gen" blocks on the block diagram confirm that a remote connection to the R&S SMBV100B is established.

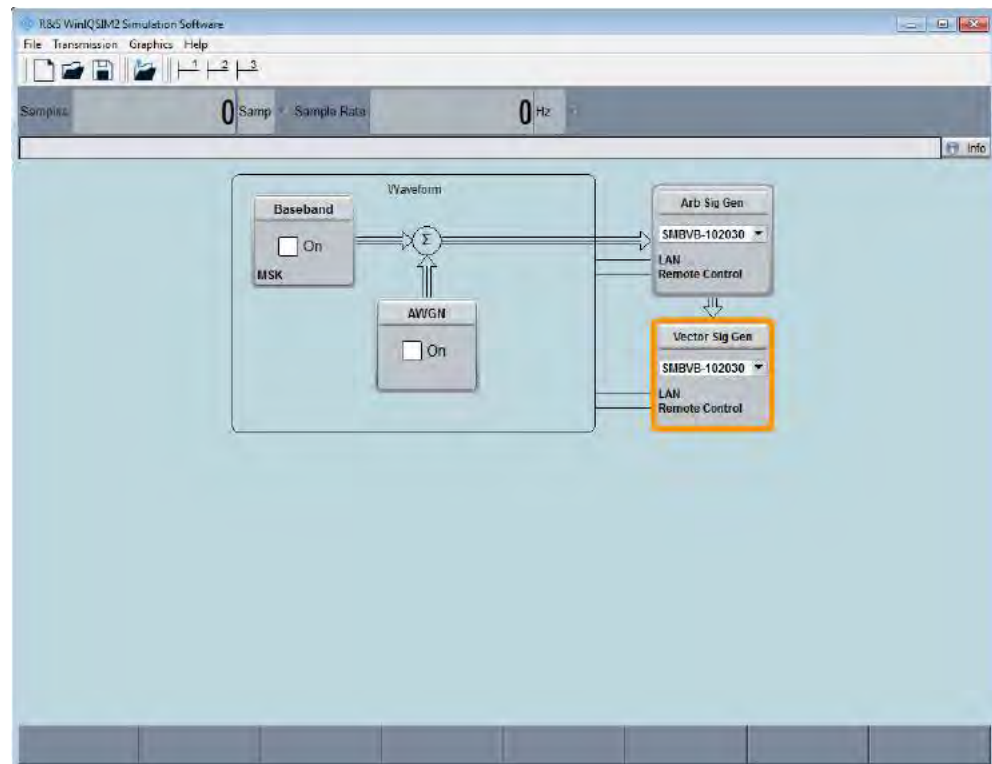

To generate a waveform file with the R&S WinIQSIM2

1. In the block diagram of R&S WinIQSIM2, select "Baseband > EUTRA/LTE/IoT".
2. Adjust the settings as required, for example:
 - a) select "Link Direction > Downlink"
 - b) select a predefined test model, "Test Setups/Models > E-TM1_1__10MHz"
3. Enable "EUTRA/LTE/IoT > State > On".

Using the Arbitrary Waveform Generator (ARB)

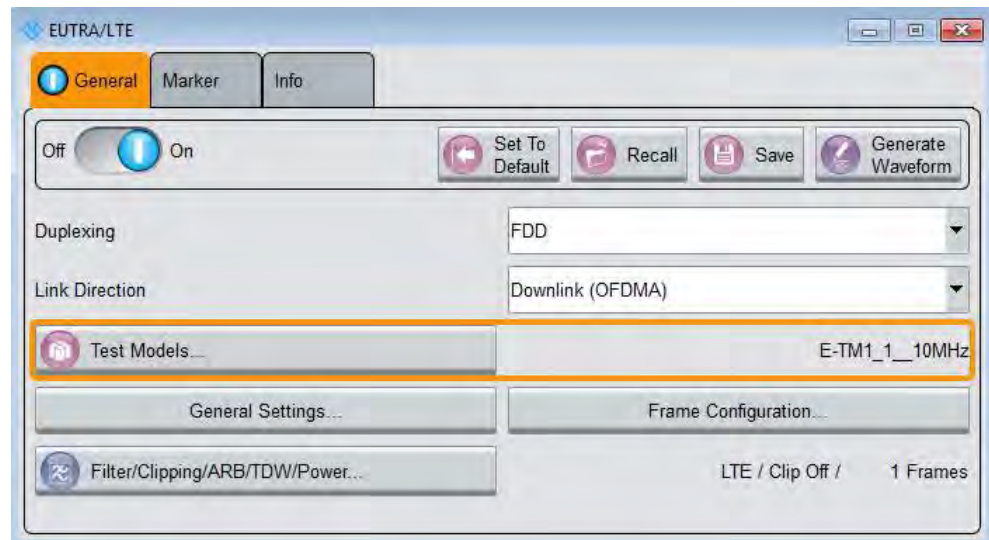

The R&S WinISIM2 calculates the signal and displays important signal parameters, like the used "Sample Rate" and "Number of Samples".

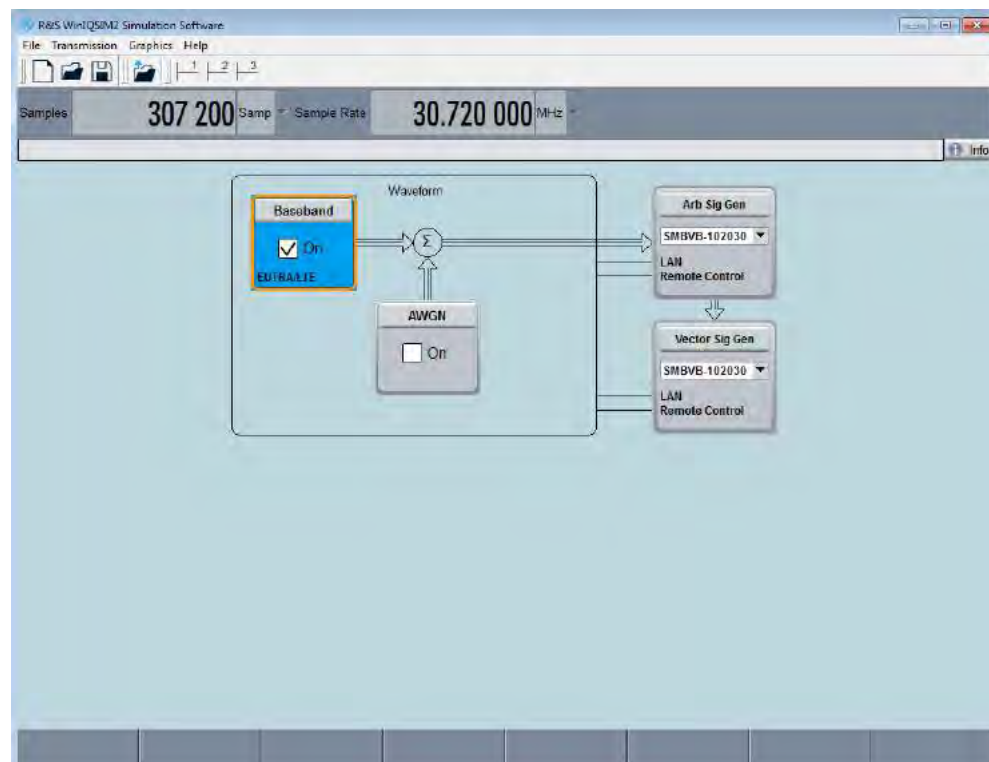



Use "Graphics > Graphic 1 (Complete)" view to retrieve more information on the generated signal.

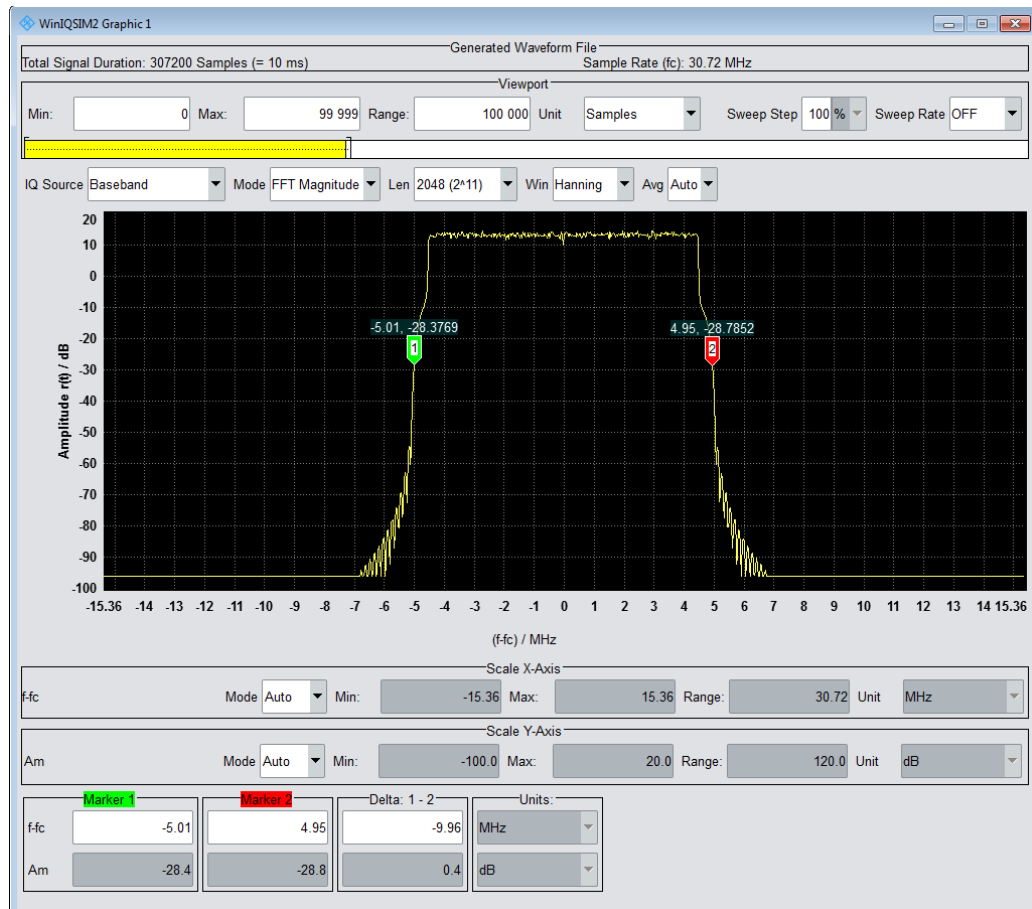

The display confirms the expected EUTRA/LTE 10 MHz spectrum.

To transfer the generated file to the R&S SMBV100B

1. In the R&S WinIQSIM2, select "Transmission > Transmit".
2. In the "Waveform Transmission to Arbitrary Waveform Generator" dialog, select:
 - a) "Transmit from > Internal (WinIQSIM2)"
 - b) "Transmit to > Instrument".
 - c) Select "File" and define the filename the transmitted file is stored as.
 - d) Enable "Automatically Load and Start Waveform > On" and select the required baseband, e.g. "Path A"
 - e) Add a comment to the waveform.
 - f) Select "Transmit".

Using the Arbitrary Waveform Generator (ARB)

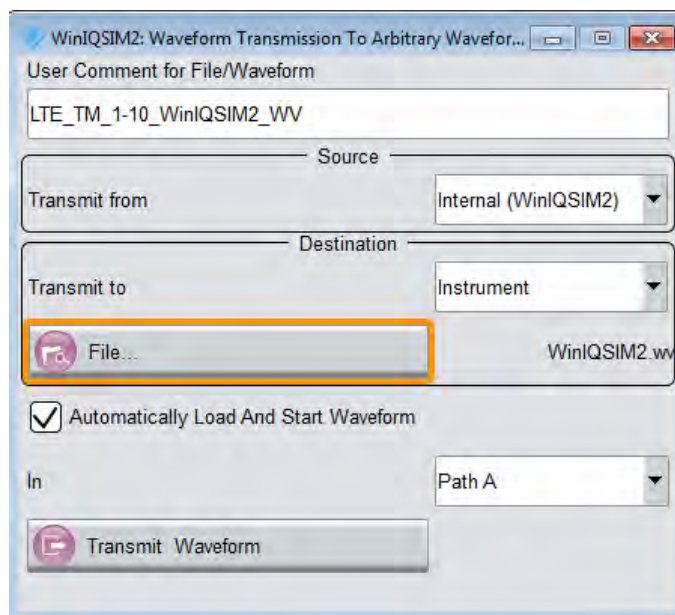

The waveform is transmitted to the default directory of the R&S SMBV100B.

3. In the R&S SMBV100B, select "Baseband > ARB".

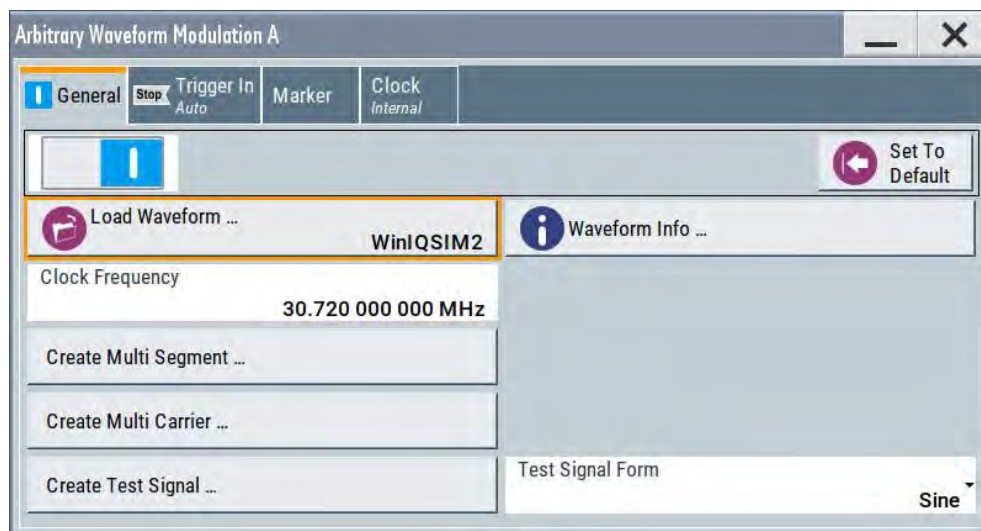

The dialog confirms that the ARB is enabled and plays the transmitted waveform.

3.6.5 References

Waveform file format

The header of the generated I/Q data files consists of "tags" which are enclosed in braces { }. During data export, the header information is written to a *.wv file.

For detailed description on all available tags and for information on how to query them or to create waveforms manually, refer to [Chapter 12.16.4.4, "Waveform, Data and List Format"](#), on page 750.

3.7 Generating Multi-Segment Waveform Files

Modern chip technologies implement several communication standards within one chip and rise special verification and test requirements. To fulfill the requirements of these test systems and to enable rapid alternation between different waveforms with differing test signals, the R&S SMBV100B provides the functionality to generate multi-segment waveform files.

This section introduces the concept of the multi-segment waveform files, together with description of the provided settings and some typical configuration examples.

3.7.1 Required Options

See [Chapter 3.6.1, "Required Options"](#), on page 145.

Multi-segment waveform files require the corresponding Digital Standard options (R&S SMBV100B-K2xx) of all included standards.

3.7.2 About the Multi-Segment Waveforms

A multi-segment waveform is a composed signal that contains several multiple independent waveforms called segments. Each segment is an independent waveform that can be output with its own marker and clock settings.

The [Figure 3-13](#) shows the principle of building a multi-segment waveform.

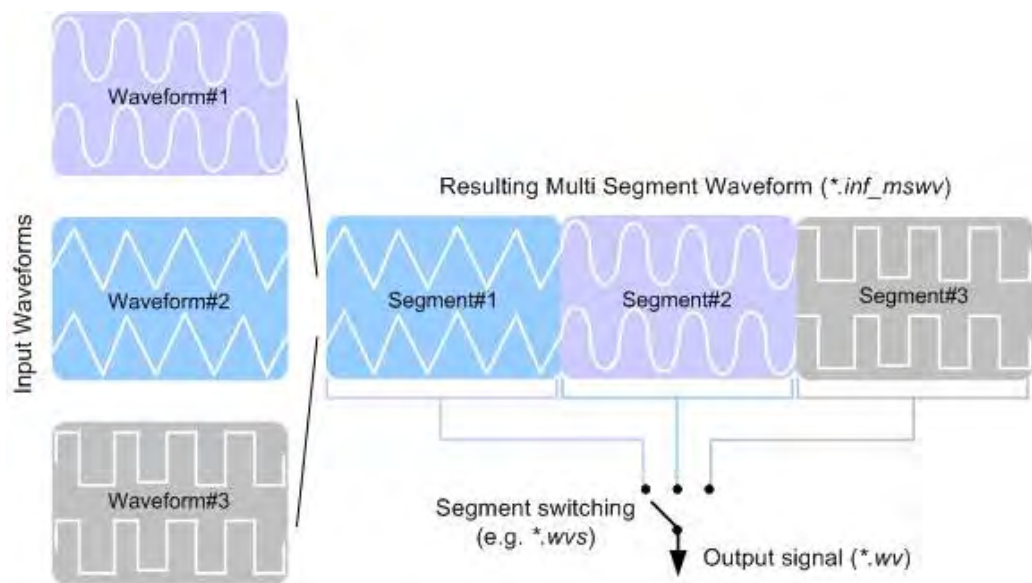

Figure 3-13: ARB Multi-Segment Waveform Concept

It is also possible to create and output a blank segment, i.e. segments containing a zero signal.

Typical applications for the multi-segment mode are described in section [Chapter 3.7.4, "How to Create and Work with the Multi-Segment Waveform Files"](#), on page 189.

3.7.2.1 Multi-Segment Waveforms Processing

Processing of the waveform is triggered by the "Create" or "Create and Load" function. To process the waveform, the instrument loads the entire multi-segment waveform into the memory. It is therefore possible to alternate between the individual waveforms without delay due to loading. You can define the output order of the segments, and the segment intended to be output at any given moment.

When the created waveform is loaded, the graphical interface displays information on clock rate, number of samples and creation day. You can also acquire information about the waveform in the dedicated "Waveform Info" dialog.

3.7.2.2 ARB Sequencer Mode

If high switch over speeds is required, the test signals can be continuously scrolled through with the aid of an external trigger or by applying a predefined "Play List". The R&S SMBV100B provides the possibility to define a sequence of different segments and to determine whether a segment is played once or repeated several times and to adjust the transition between the segments.

For the correct and fast processing and for seamless transition between the multiple waveforms, segments with a common sample rate are required. If the combined waveforms features different sample rates, they have to be adapted to a common sample

rate by resampling. Another advantage of this procedure is the scaling of the instantaneous amplitude of the various waveforms to a common RMS level.

3.7.2.3 File Concept

To provide flexible configuration, the building of a composed multi-segment waveform file involves different stages; by completing of each of them, the R&S SMBV100B creates and stores a dedicated file. The following files are used:

- **Configuration list:** is a dedicated file with details on how a multi-segment waveform is made up from different waveforms, the level and the clock rate settings, and the filename. The file extension is `*.inf_mswv`.
You can create any number of configurations as a basis for defining further multi-segment waveforms.
- **Output file:** is the created output multi-segment waveform file. The R&S SMBV100B stores it under a user definable name; as with the standard waveforms, the used file extension is `*.wv`. The instrument appends additional information to the header of the composed waveform file, e.g. user comments.
- **Sequencing list:** are files created in the "Multi Segment Waveform Sequencing" dialog, i.e. when the ARB sequencer mode is used (see [Chapter 3.7.2.2, "ARB Sequencer Mode"](#), on page 168).
The sequencing list file has an extension `*.wvs` and is automatically assigned to but independent from the multi-segment file. By default, both files have the same name and are located in the same file directory. You can create more than one sequencing list file per multi-segment waveform file.
The sequencing list file carries information only about the segment number, the corresponding waveform filenames are retrieved from the assigned multi-segment waveform file. That is, the same sequencing list file can be reused for different multi-segment waveform files with the same number of segments.
Changes and recalculations of a multi-segment waveform file cause a recheck whether the assigned sequencing list files are still valid. A message is displayed to inform about necessary corrections in the "play list".

3.7.2.4 Impact of the Marker Settings

The general purpose of the marker signal is the triggering of the DUT (device under test) and the synchronization with other measurement instruments.

For better flexibility, the instrument provides several possibilities to define marker signals:

- **Segment markers**
Because the multiple segments are standalone waveforms, they can already carry marker signals. You can define how the instrument processes these available marker signals. The instrument can ignore them or use them in the composed multi-segment waveform.
- **Additional segment restart and sequence restart markers**
Additional marker signal can be defined to restart the multi-segment sequence or to restart each of the multiple segments. A marker output configured and defined

for one of these purposes overwrites markers that use the same output connector and that are defined in the individual waveforms.

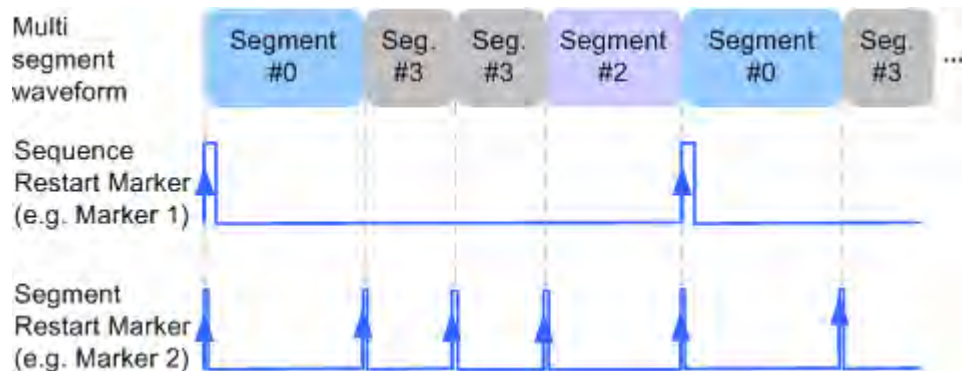

Figure 3-14: Example of marker signals

The segment begin is defined by the low-high slope of the marker, which applies for switching between two segments and if there is a segment replay.

- General marker signals for the composed multi-segment waveform
The "ARB" dialog provides also access to the standard marker settings. Settings other than "unchanged" overwrite existing marker in the waveforms or markers defined for the multi-segment waveform.

The Figure 3-15 shows schematically how the instrument evaluates the priorities of the different marker signals, if multiple marker signals are mapped to the same connector.

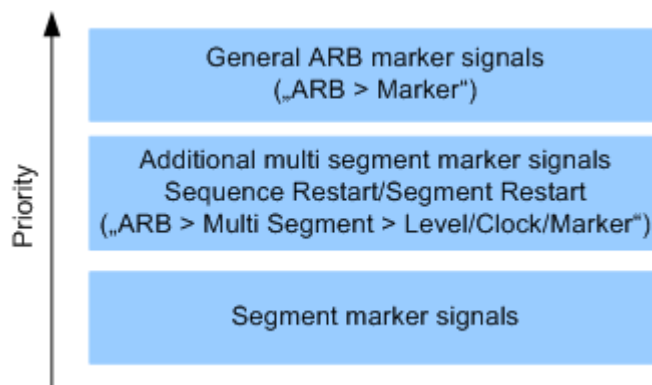

Figure 3-15: Marker priority used by assigning of marker signals to a hardware connector

3.7.2.5 Impact of the Trigger Settings and Next Segment Settings

The ARB dialog is equipped with the standard (regular) trigger settings. These settings are provided for triggering of the composed multi-segment waveform as a **sequence**, i.e. as one file. The functions provided in the "Trigger" tab and their effect are described in Chapter 3.4.1.3, "Baseband Trigger Signals", on page 96.

This section focuses on the additional settings provided for triggering of the individual segments building the composed multi-segment waveform. These settings are enabled and visible only if a multi-segment waveform is loaded for processing. The settings are grouped in the "Multi Segment Waveform Options/Next Segment Trigger In" section.

The Figure 3-16 illustrates how trigger events affect the processing of the multi-segment waveforms.

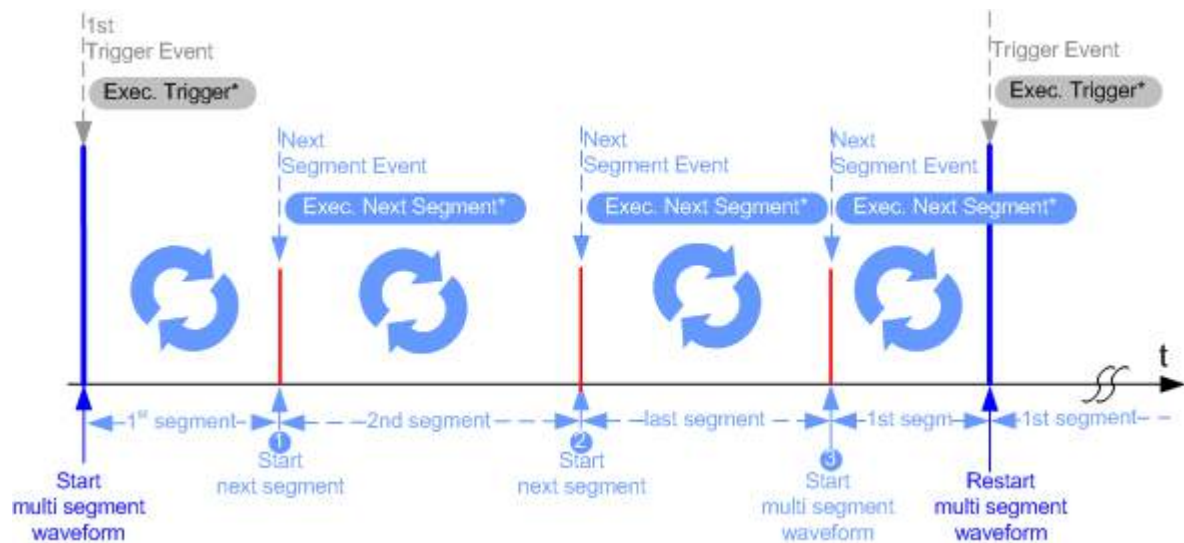

Figure 3-16: Principle of segment triggering

- * = To simplify the description, an internal next segment trigger event ("Exec. Next Segment") and an internal trigger event ("Execute Trigger") are used; an external trigger event has the same effect on the signal generation.
- 1, 2 = Any next segment trigger event (internal or external) causes a switch over to the subsequent available segment in the waveform. The currently output segment (segment filename and segment index) is indicated at "Current Segment".
- 3 = When the last segment of the multi-segment waveform is output, the sequence starts again with the output of the first segment after the subsequent trigger event. Hence, a sequence of external next segment trigger events can be used to cyclically output the segments in the multi-segment file.

Defining Next Segment Source

As with the standard trigger system, provided are the following two sources for the next segment signal:

- **Internal:** the switch over to the subsequent segment is triggered manually with the "Execute Next Segment" function.
To trigger a switch over to any segment within the multi-segment waveform, change the value of the parameter "Segment".
- **External:** the instrument expects a trigger event ("Global Next Segment") on one of the two provided and configured User connectors.

Defining the Subsequent Segment

By default, the instrument replays the segments in incremental order, e.g. Segment#1, Segment#2, etc. If other order is required, use one of the following possibilities to define the segment to be played next:

- **Next Segment:** defines the subsequent segment while triggering the segments manually, i.e. by "Next Segment Source > Internal"
- **Sequencing List:** the subsequent segment is defined in the selected play list.

Defining the Transition between the Segments

The R&S SMBV100B provides the parameter "Next Segment Mode" to define the transition to the subsequent segment (see the graphs in [Transition examples](#)).

- **Next Segment:** by receiving a Next Segment Event, the ARB aborts immediately the playing of the current waveform and starts playing the next segment waveform (see [Table 3-14](#)).
- **Next Segment Seamless:** by receiving a Next Segment Event, the ARB completes the processing of the current waveform before starting the next segment waveform (see [Table 3-14](#)).

Use this setting to avoid signal gaps and wrap-around problems. Seamless transition requires segments with equal clock rates.

Another way to generate a multi-segment signal without signal gaps between the segments is to use the provided ARB sequencer mode (see [Chapter 3.7.3.4, "Multi-Segment Waveform Sequencing"](#), on page 181).

The [Table 3-14](#) shows two examples of the transition from a sine-wave signal segment to a sawtooth segment (1 channel, upper curve) in the case of next segment external triggering. The left graphic displays an abrupt transition; the right graphic, the **seamless** transition case.

Table 3-14: Transition examples

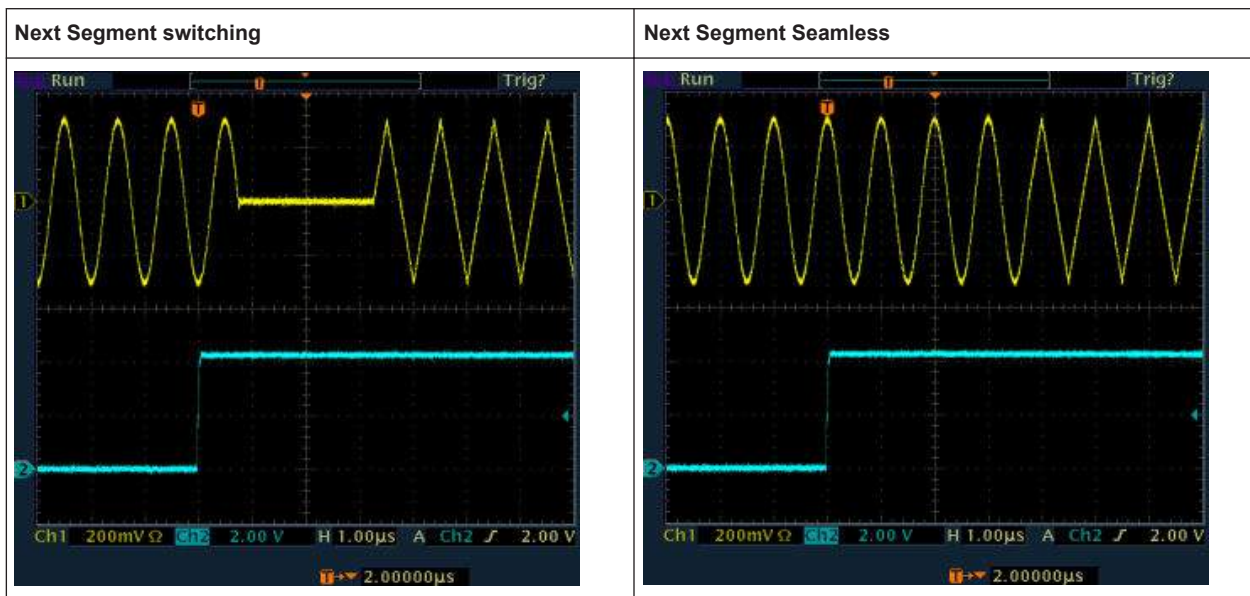

Understanding the Trigger Examples



A simplified diagram in the ARB dialog is intended to explain the effect of the triggering on the signal processing. The currently enabled settings for trigger and next segment mode are considered.



The curves plotted in the dialog are textbook examples, "not measured" waveforms. They are intended to visualize the trigger and the next segment settings more clearly.

- The triangle on the top line denotes a trigger event. A filled triangle on the bottom line denotes a next segment event.
- A green sine wave (or other shape) over a full period indicates one replay cycle of a segment. A shorter example signal indicates a replay cycle which was interrupted, e.g. due to a next segment event (compare the two graphics in [Table 3-15](#)).

Table 3-15: Trigger examples in the ARB dialog

"Next Segment Mode = Next Segment"	"Next Segment Mode = Next Segment Seamless"
	

3.7.3 Multi-Segment Settings

Access:

1. Select "Baseband > ARB > General > Create Multi Segment".

The "ARB: Multi Segment" dialog enables direct assignment of waveforms to the multiple segments, adjusting the clock, level, and marker settings of the composed waveform and selecting the output file.

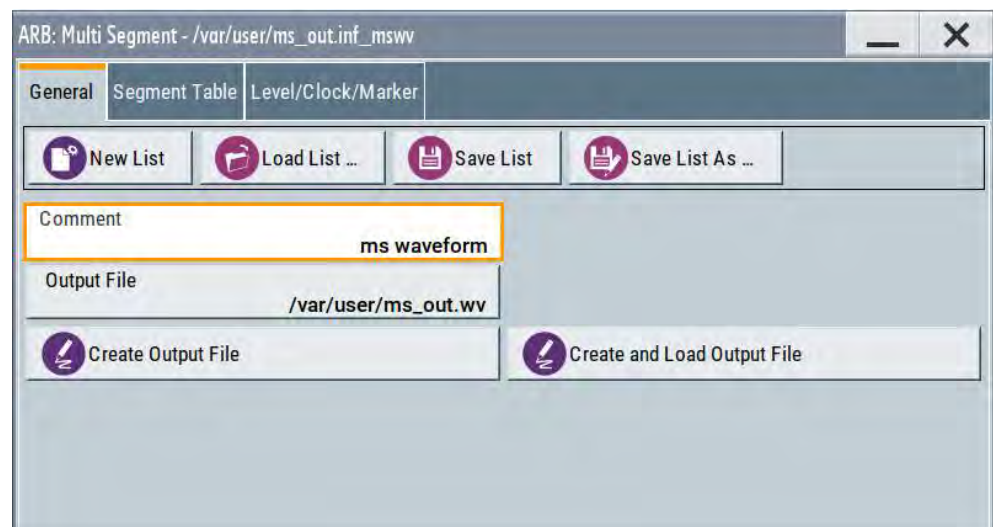

For description on the provided settings, refer to:

[Chapter 3.7.3.1, "Setting for Handling the Multi-Segment Files and Output File Settings"](#), on page 174,

[Chapter 3.7.3.2, "Segment Table"](#), on page 176 and

[Chapter 3.7.3.3, "Level / Clock / Marker Settings"](#), on page 179

2. Select "ARB: Multi Segment > General" > **"Create and Load Output File"** to store and load current multi-segment file.

3. Select "Multi Segment" > "**Sequencing List**" to access the settings for configuring a sequencing "Play List" for fast automatic processing of the multi-segment waveform.
For a description of the provided settings, refer to [Chapter 3.7.3.4, "Multi-Segment Waveform Sequencing"](#), on page 181.
4. Select "Baseband > ARB > General".
The "Load Waveform" confirms that the current multi-segment file is loaded (filename as defined with "Output File").
Note: The provided settings depend on the current waveform.
The "Sequencing List" function for instance requires that:
 - Multi segment file is created, i.e. you have executed "**Create Output File/ Create and Load Output File**".
 - "Sequence Table" contains **more than one segment**.
5. Select "Baseband > ARB > Trigger In (MSW)".
For a description of the provided settings, refer to [Chapter 3.7.3.5, "Next Segment Trigger In Settings"](#), on page 186.
6. Select "Baseband > ARB > General > State > On" to process the configured multi-segment waveform.

The remote commands required to define these settings are described in [Chapter 12.16.4.3, "SOURce:BB:ARbitrary Subsystem"](#), on page 707.

- [Setting for Handling the Multi-Segment Files and Output File Settings](#)..... 174
- [Segment Table](#)..... 176
- [Level / Clock / Marker Settings](#)..... 179
- [Multi-Segment Waveform Sequencing](#)..... 181
- [Next Segment Trigger In Settings](#)..... 186

3.7.3.1 Setting for Handling the Multi-Segment Files and Output File Settings

Access:

1. Select "Baseband > ARB > General > Create Multi Segment".
The "General" tab comprises standard functions for file handling, like selecting and loading of files, or determining the output filename.
2. Perform one of the following:
 - Select "New List" to create a multi-segment waveform file
 - Select "Load List" to load an existing one
3. Add a comment and select "Output File" to define the filename the multi-segment waveform is created at.
Note: The provided settings depend on the current waveform.
The "Sequencing List" function for instance requires that:
 - Multi segment file is created, i.e. you have executed "**Create Output File/ Create and Load Output File**".

- "Sequence Table" contains **more than one segment**.

Settings:

New List.....	175
Load List.....	175
Save List/Save List As.....	175
Sequencing List.....	175
Comment.....	175
Output file.....	176
Create/Create and Load.....	176

New List

Accesses the standard "Create Multi Segment Waveform List" function to enter the name of the new file.

Remote command:

`[:SOURce<hw>] :BB:ARbitrary:WSEGment:CONFigure:SElect` on page 732

Load List

Accesses the standard "File Select" function to select the configuration file to be edited.

Remote command:

`[:SOURce<hw>] :BB:ARbitrary:WSEGment:CONFigure:CATalog?` on page 730

`[:SOURce<hw>] :BB:ARbitrary:WSEGment:CONFigure:SElect` on page 732

Save List/Save List As...

Saves the current entries of the [Segment Table](#) in a configuration list (file), including the level mode, clock mode, segment marker mode, and output filename settings.

See also [Chapter 3.7.2.3, "File Concept"](#), on page 169.

Consider also the following remote control commands:

- To define the configuration file (`*.inf_mswv`) used by the calculation of the output file:
 - `[:SOURce<hw>] :BB:ARbitrary:WSEGment:CREate`
 - `[:SOURce<hw>] :BB:ARbitrary:WSEGment:CLOad`
- To define the filename of the output waveform file (`*.wv`):
 - `[:SOURce<hw>] :BB:ARbitrary:WSEGment:CONFigure:OFILe`

Remote command:

n.a.

Sequencing List

Accesses the dedicated dialog for configuring the associated play lists, see [Chapter 3.7.3.4, "Multi-Segment Waveform Sequencing"](#), on page 181.

This function is enabled, if a multi segment file is created or created and loaded.

Remote command:

n.a.

Comment

Adds a comment to the composed multi-segment file.

Remote command:

`[:SOURce<hw>] :BB:ARbitrary:WSEgment:CONFigure:COMment` on page 731

Output file

Accesses the standard "File Select" dialog function and requests the filename for the multi-segment waveform to be calculated.

An output filename is required for further processing of the multi-segment waveform:

- For the internal storage triggered by the "Save List" function
- For the calculation and creation of the multi-segment waveform, triggered by the "Create" or "Create and Load" function.

Remote command:

`[:SOURce<hw>] :BB:ARbitrary:WSEgment:CONFigure:OFILe` on page 731

Create/Create and Load

- "Create"
Creates a multi-segment waveform using the current entries in the [Segment Table](#).
- "Create and Load"
Creates a multi-segment waveform and loads it in the ARB generator.

The R&S SMBV100B stores the multi-carrier waveform as file with filename as specified with parameter [Output file](#).

Depending on the configuration of the multi-carrier waveform, calculation takes some time. Use the "Abort" function, to interrupt the calculation.

Remote command:

To define the configuration file (*.inf_mswv) used by the calculation of the output file:

`[:SOURce<hw>] :BB:ARbitrary:WSEgment:CREate`

Or `[:SOURce<hw>] :BB:ARbitrary:WSEgment:CLoad`

To define the filename of the output waveform file (*.wv):

`[:SOURce<hw>] :BB:ARbitrary:WSEgment:CONFigure:OFILe`

3.7.3.2 Segment Table

Access:

1. Select "Baseband > ARB > General > Multi Segment".
2. In the "ARB: Multi Segment > General" dialog, select an existing list.
3. Select "ARB: Multi Segment > Segment Table".
4. Select "Append" to add *existing* waveform segments.

5. Select "Append Blank" to add a blank segment and configure the "Blank Segment Settings" as required.



This section explains the settings, necessary to create and adjust the contents of the multi-segment file.

Settings:

Multi Segment Table	177
Append/Delete/Shift Seg. Up/Down	178
Blank Segment	178

Multi Segment Table

The table lists the individual waveforms (segments) of the selected multi-segment waveform. The information about the segments is retrieved from the tags of the corresponding waveform files.

"Segment#"	Indication of segment index. Within the manual and remote control configuration, this segment index indicates the segment explicitly. Tip: Use the segment index, for example, to define the subsequent sequence to be output in Next Segment Mode "Next Segment" or "Next Segment Seamless".
"Waveform"	Indication of the waveform filename of the segment.
"Clock Rate"	Indication of the clock rate of the selected waveform.
"Samples"	Indication of the number of samples in the segment.
"Period"	Indication of the segment duration.
"Path"	Indication of the location of the waveform file used for the corresponding segment.

"Comment" Indication of the possible comment contained in the waveform.

"Info" Indication of the possible comment contained in the waveform.

Remote command:

`[:SOURCE<hw>] :BB:ARbitrary:WSEgment:CONFigure:SEGment:CATalog?`
on page 726

Append/Delete/Shift Seg. Up/Down

Standard handling functions:

"Append" Opens the standard "File Select" dialog for navigation to and selection of the waveform file to be added on the end of the existing list. Only non-multi segment waveforms can be loaded.

"Delete" Removes the selected entry from the table. The waveform file itself is however not deleted.

"Shift Seg.# Up/Down" Rearranges the segments, i.e. moves the selected segment up and down.

Remote command:

`[:SOURCE<hw>] :BB:ARbitrary:WSEgment:CONFigure:SEGment:APPend`
on page 731

`[:SOURCE<hw>] :BB:ARbitrary:WSEgment:CONFigure:DElete` on page 731

Blank Segment

Comprises the settings of a blank segment. A blank segment is a zero signal with defined clock rate and number of samples.

"Clock Rate" Selects the clock rate of the blank segment.

Remote command:

`[:SOURCE<hw>] :BB:ARbitrary:WSEgment:CONFigure:BLANK:APPend`
on page 729

"Samples" Selects the number of samples for the blank segment.

Remote command:

`[:SOURCE<hw>] :BB:ARbitrary:WSEgment:CONFigure:BLANK:APPend`
on page 729

"Period" Displays the resulting period for the blank segment.

"Append Blank" Adds the blank segment to the multi-segment file.

Remote command:

`[:SOURCE<hw>] :BB:ARbitrary:WSEgment:CONFigure:BLANK:APPend`
on page 729

3.7.3.3 Level / Clock / Marker Settings

Access:

1. Select "Baseband > ARB > General > Multi Segment".
2. In the "ARB: Multi Segment > General" dialog, select an existing list.
3. Select "ARB: Multi Segment > Segment Table" and configure the segments.
4. Select "ARB: Multi Segment > Level/Marker/Clock".

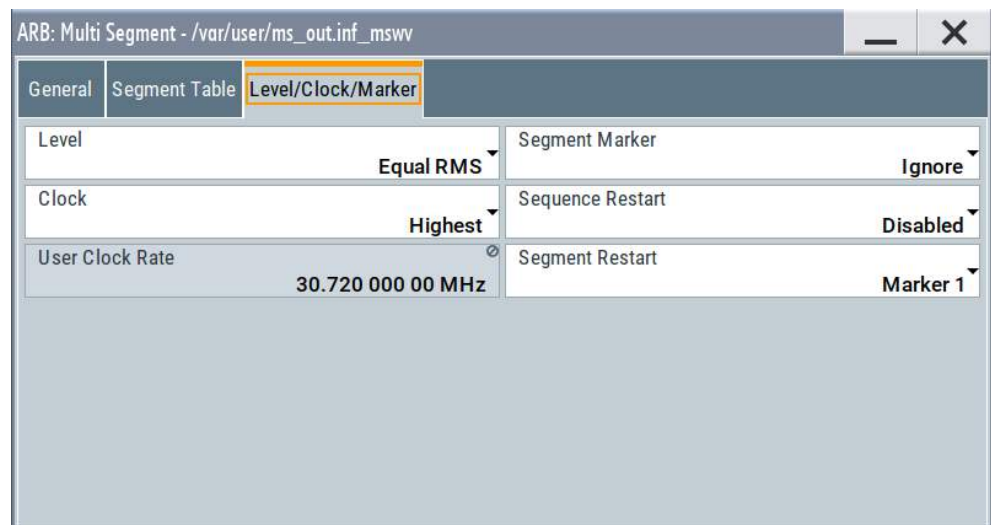

The "Level/Marker/Clock" tab provides the parameters necessary to adjust the level, marker and clock settings for the selected multi-segment waveform file.

Settings:

Level.....	179
Clock.....	180
User Clock Rate.....	180
Segment Marker.....	180
Sequence Restart.....	180
Segment Restart.....	181

Level

Defines the way the instrument determines the output level of each of the multiple waveforms.

- | | |
|-------------|--|
| "Unchanged" | Concerning the level settings, the segments are output exactly as defined in the individual files. The "Level" display applies only to the segment with the highest RMS value. Sometimes, the remaining segments are output at a lower level than the displayed value. |
| "Equal RMS" | Segments are output so that all segments have the same RMS value. The "Level" display applies to all segments. |

Remote command:

```
[ :SOURce<hw> ] :BB:ARbitrary:WSEgment:CONFigure:LEVel [ :MODE ]
```

on page 730

Clock

Defines the way the instrument determines the clock rate of each of the multiple waveforms.

- | | |
|-------------|---|
| "Unchanged" | Each segment is output with the clock rate defined in its waveform file.

Note: Segments with equal clock rates are required for "Next Segment Mode > Next Segment Seamless". |
| "Highest" | All segments are output at the highest available clock rate.

Note: Trade-off between fast switch over and computing time. This mode provides short switch over times between segments. However, the computing time increases because the individual segments are resampled. |
| "User" | All segments are output at the clock rate defined by the parameter "User Clock".
This mode is a trade-off between fast switch over and computing time, too. |

Remote command:

```
[ :SOURce<hw> ] :BB:ARbitrary:WSEgment:CONFigure:CLOCK:MODE
```

on page 730

User Clock Rate

Defines the sample rate used for multi-segment waveform output, if "Clock Mode > User" is selected.

Remote command:

```
[ :SOURce<hw> ] :BB:ARbitrary:WSEgment:CONFigure:CLOCK on page 730
```

Segment Marker

Defines the way the marker information within the separate segments is processed, see also [Chapter 3.7.2.4, "Impact of the Marker Settings"](#), on page 169.

- | | |
|-------------|--|
| "Ignore" | The marker information carried in the individual segment waveform files is not considered. |
| "Take Over" | The output waveform file contains the marker information as configured in the individual waveform files. |

Remote command:

```
[ :SOURce<hw> ] :BB:ARbitrary:WSEgment:CONFigure:MARKer:MODE
```

on page 728

Sequence Restart

Enables/disables the generation of an extra restart marker in the output waveform file.

If additional marker generation is enabled, the existing marker signals in the individual segment waveform files are not considered, see also [Chapter 3.7.2.4, "Impact of the Marker Settings"](#), on page 169.

"Disable" No additional marker is generated.

"Marker 1, 2, 3"

Generates a restart marker signal at the beginning of the first segment of the complete multi-segment sequence.

Remote command:

`[:SOURce<hw>] :BB:ARbitrary:WSEgment:CONFigure:MARKer:FSEgment`
on page 728

Segment Restart

Enables/disables the generation of an extra restart marker in the output waveform file.

If additional marker generation is enabled, the existing marker signals in the individual segment waveform files are not considered, see also [Chapter 3.7.2.4, "Impact of the Marker Settings"](#), on page 169.

"Disable" No additional marker is generated.

"Marker 1, 2, 3"

Generates a restart marker signal at the beginning of each segment. The segment begin is defined by the low-high slope of the marker signal, which applies for switching between two segments and if there is a segment replay.

Remote command:

`[:SOURce<hw>] :BB:ARbitrary:WSEgment:CONFigure:MARKer:ESEgment`
on page 728

3.7.3.4 Multi-Segment Waveform Sequencing

Access:

1. Select "Baseband > ARB > General > Multi Segment".
2. In the "ARB: Multi Segment > General" dialog, select an existing list.
3. Select "ARB: Multi Segment > Segment Table" and configure a waveform with more than one segment.
4. Select "ARB: Multi Segment > Level/Marker/Clock" and adjust the clock settings so that all segments use the same clock rate.
5. Select "ARB: Multi Segment > General" > **"Create Output File/Create and Load Output File"**.
6. Select "Sequencing List..."
7. Select "New" or "Load" to load a sequencing list file.



8. Select "ARB: Multi Segment Waveform Sequencing > Sequencing Play List" to create a "play list".

A new sequencing list contains no information.

9. Use the "Append/Delete" and "Up/Down" functions to configure the order the segments are processed.

The user interface shows the configured play list in form of a "Sequencing Graphic".

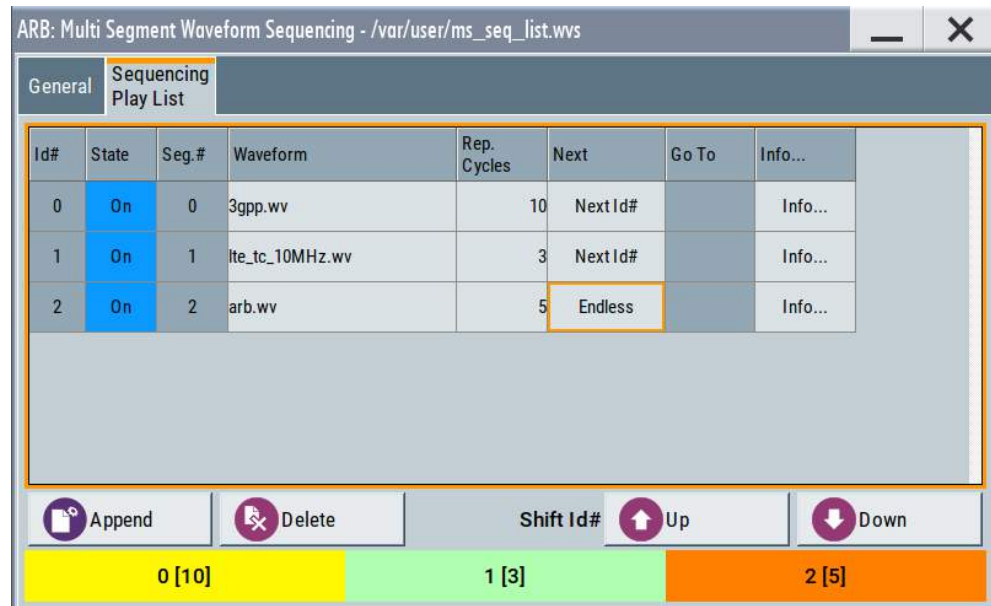

Refer to "[Sequencing Play List Settings](#)" on page 184 for description of the provided settings.

10. Select "ARB: Multi Segment Waveform Sequencing > General > Save" to store the "play list".

11. Select "ARB: Multi Segment > General > Create and Load Output File" to store and load current multi-segment file.
12. To enable the instrument to use the configured "play list", select "ARB > Next Segment Waveform Options > Next Segment Mode > Sequencer".



All segments in a "play list" must have the same clock rate.

Settings:

- [General Settings](#)..... 183
- [Sequencing Play List Settings](#)..... 184

General Settings

Access:

- ▶ Select "Baseband > ARB > General > Multi Segment > Sequencing List..."

Settings:

- [New/Load Sequencing List](#)..... 183
- [Save List/Save List As](#)..... 183
- [Sequencing List](#)..... 183
- [Assigned to Multi Seg. Waveform](#)..... 183

New/Load Sequencing List

Accesses the standard "Select Sequencing List" function to define the name of the new play list file or select of an existing one.

Remote command:

`[:SOURce<hw>] :BB:ARbitrary:WSEgment:SEquence:SElect` on page 726

Save List/Save List As

Saves the current entries of the table in a play list file. Play list files have the file extension *.wvs.

The default filename of the play list file is the same as the multi-segment waveform filename, but it can be changed.

Sequencing List

Displays the name of the selected sequencing list file, i.e. the file with the "play list" settings (see [Chapter 3.7.2.3, "File Concept"](#), on page 169).

Remote command:

n.a.

Assigned to Multi Seg. Waveform

Displays the name of the multi-segment waveform file the current sequencing list file is assigned to.

Remote command:
n.a.

Sequencing Play List Settings

Access:

- ▶ Select "Baseband > ARB > General > Multi Segment > Sequencing List... > Sequencing Play List".

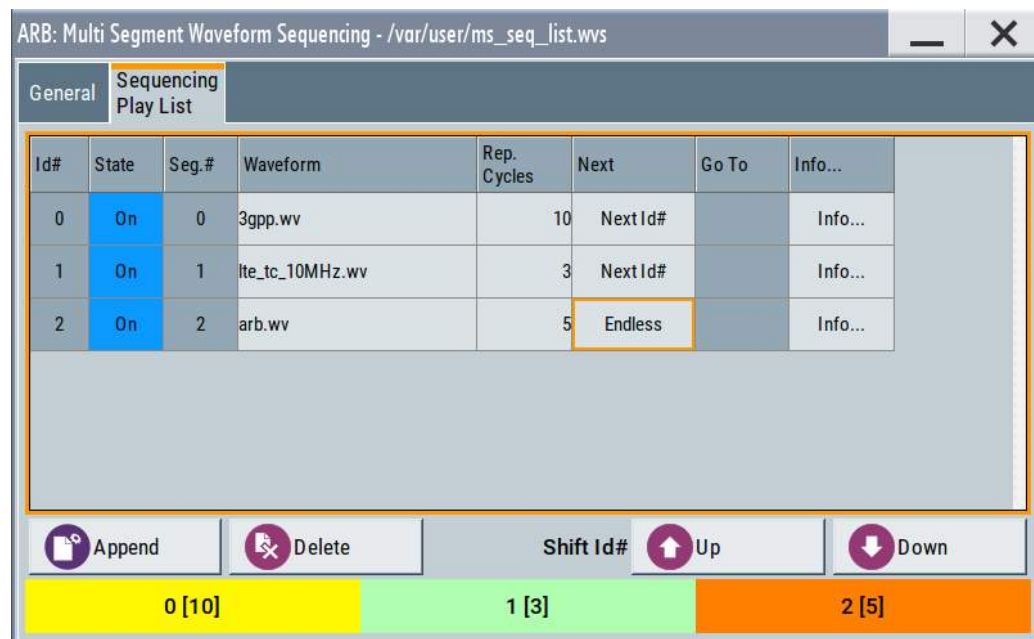

Settings:

Sequencing Play List.....	184
L Next.....	185
L Append.....	185
L Delete.....	185
L Shift Id# Up/Down.....	185
Sequencing Graphic.....	185

Sequencing Play List

The "Sequencing Play List" table defines the sequence order the waveform file segments are processed and how many times each of them is repeated.

"Id#"	Indicates the row number.
"State"	Enables/disables the selected row. Only active segments are processed.
"Segment#"	Indicates the segment index. The sequencing list file carries information only about the segment index, the corresponding filenames are retrieved from the assigned multi-segment waveform file.

"Waveform"	Indicates the waveform file mapped to the corresponding segment. The filename is retrieved from the assigned multi-segment waveform file. Available are only waveform files from the pool of segments of the selected multi-segment waveform file.
"Repetition Cycles"	Sets the number of times the selected segment is cyclically repeated before the next segment in the sequence is processed.
"Info"	Opens a dialog with detailed information about the currently selected waveform.

Remote command:

See ["Append"](#) on page 185

Next ← Sequencing Play List

Determines the action after completing the current one, like for instance which segment is processed after the processing of the current one is finished.

"Next Id#"	The next active segment in the play list is processed.
"Blank"	After the processing of the current segment is completed, the signal output is stopped until a signal restart like a retrigger signal is received. A restart signal causes a complete restart of the sequencing play list.
"Endless"	The current segment is replayed until a signal restart like a retrigger signal is received and the complete sequencing play list is restarted. Only active segments are considered.
"Goto Id#"	Determines the row number of the segment to be processed next. This feature is limited to the first 32 rows.

Append ← Sequencing Play List

Inserts a new row at the end of the sequencing play list table.

Remote command:

[\[:SOURCE<hw>\]:BB:ARbitrary:WSEgment:SEquence:SElect](#) on page 726

[\[:SOURCE<hw>\]:BB:ARbitrary:WSEgment:SEquence:APPend](#) on page 727

Delete ← Sequencing Play List

Deletes the selected row.

Shift Id# Up/Down ← Sequencing Play List

Rearranges the rows, i.e. moves the selected row up and down.

Sequencing Graphic

Displays the play list graph according to the current configuration.

The graph shows the segment sequence, the segment number, and the number of times, the segment is repeated; considered are only the active segments.

3.7.3.5 Next Segment Trigger In Settings

The "Next Segment Trigger" settings are enabled only if a multi-segment waveform is loaded into the ARB.

Access:

1. Enable and load a multi-segment waveform in the ARB, see [Chapter 3.7.3, "Multi-Segment Settings"](#), on page 173.
2. Select "Baseband > ARB > Trigger In (MSW)".

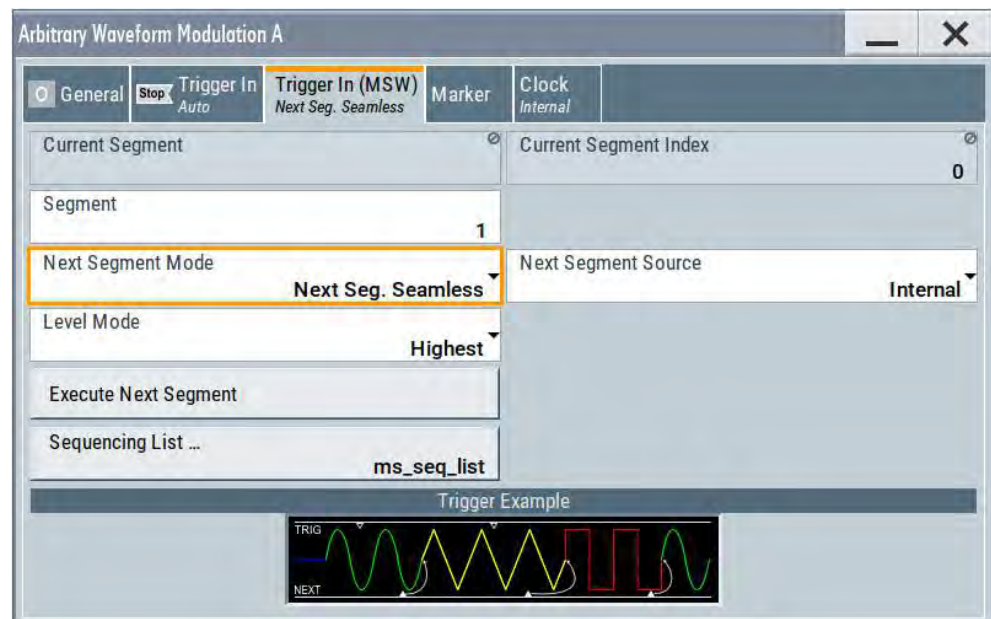

The "Next Segment Trigger In" section comprises the settings necessary to adjust the trigger for switching between the segments of a multi-segment waveform. The parameters displayed depend on the selected trigger source.

Settings:

Current Segment/Current Segment Index	186
Segment	187
Next Segment Mode	187
Next Segment Source	188
Level Mode	188
Execute Next Segment	188
Sequencing List	188
Trigger Example	189

Current Segment/Current Segment Index

Indicates the waveform segment (segment filename and index) that is output.

Remote command:

`[:SOURce<hw>] :BB:ARBitrary:WSEGment?` on page 725

`[:SOURce<hw>] :BB:ARBitrary:WSEGment:NAME?` on page 725

Segment

Selects the waveform segment to be output after the segment indicated as "Current Segment". This parameter determines the start segment when switching on the ARB and enables switching over to any other segment.

The following events cause a switch over:

- An external next segment trigger event
- An internal segment trigger, that is a change in the segment index in the "Segment" field

Use the parameter [Next Segment Mode](#) to define whether the new segment is generated immediately or only after the previous segment has been fully generated (wrap around). The subsequent trigger event after the last segment causes the first segment to be output again.

For more information, see [Chapter 3.7.2.5, "Impact of the Trigger Settings and Next Segment Settings"](#), on page 170.

Remote command:

`[:SOURce<hw>] :BB:ARbitrary:WSEgment:NEXT` on page 725

Next Segment Mode

Defines the way the **switch over between the segments** in a multi-segment waveform is executed.

The regular trigger mode for starting the waveform generation and **triggering the whole multi-segment sequence** is set with the parameters in the "ARB > Trigger" tab. The segment currently being output is displayed at "Current Segment". The "Trigger Example" graph displays schematically the waveform output, depending on the activated trigger and the next segment settings.

For background information, refer to [Chapter 3.7.2.5, "Impact of the Trigger Settings and Next Segment Settings"](#), on page 170.

For detailed information on how the regular trigger signal affects the multi-segment waveform processing in combination with the different values for "Next Segment Mode", refer to [Chapter 3.7.5, "Reference to Triggering of Multi-Segment Waveforms"](#), on page 194.

Note: The seamless switch over and the sequencer mode require segments with equal sample rate.

"Same Segment"

The processing of the multi-segment waveform file is similar to the processing of a non-multi segment waveform, i.e. there is no switching to consecutive segment upon the receiving of a trigger event. To trigger switching between the segments, change the segment index in the "Segment" field.

"Next Segment"

The current segment ceases to be output when a trigger event for a new segment occurs, and the new segment starts to be output after a system-imposed signal gap.

"Next Segment Seamless"

If all segments have the same sample rate, the new segment is not output until the whole of the current segment has been output (wrap around), i.e. the signal transition is seamless.

"Sequencer"

The waveform files are processed according to the order and repetition cycles defined in the special sequencing list file (*.wvs) assigned to the multi-segment waveform file.

This "play list" is defined in the [Multi-Segment Waveform Sequencing](#) dialog.

Remote command:

`[:SOURce<hw>] :BB:ARbitrary:TRIGger:SMODE` on page 728

Next Segment Source

Determines whether the next segment is switched upon receiving of an external trigger signal or upon executing of software next segment trigger (see [Figure 3-16](#)).

This parameter is disabled, if a sequencing play list is used.

"Internal"

Switch over to any segment is triggered manually with the "Execute Next Segment" function.

"Global Next Segment"

The trigger event for switching to the next segment is input as configured on one of the User x connectors.

See [Chapter 10.2, "Configuring the Global Connectors"](#), on page 486.

Remote command:

`[:SOURce<hw>] :BB:ARbitrary:WSEGment:NEXT:SOURce` on page 726

Level Mode

Sets how the instrument levels the individual segments in a multi-segment signal. The parameter is important, if waveforms with different crest factors are used.

"Highest"

All segments are output at the highest available crest factor.

"Unchanged"

Each segment is output with the crest factor defined in its waveform file.

Remote command:

`[:SOURce<hw>] :BB:ARbitrary:WSEGment:LMODE` on page 726

Execute Next Segment

For "Next Segment Source = Internal", triggers manually switch over to the subsequent segment in the multi-segment file. The subsequent segment can be any segment within the multi-segment file and is defined by the parameter "Segment"

This parameter is disabled, if a sequencing play list is enabled.

Remote command:

`[:SOURce<hw>] :BB:ARbitrary:WSEGment:NEXT:EXECute` on page 725

Sequencing List

Opens a dialog box for defining the "play lists", see [Chapter 3.7.3.4, "Multi-Segment Waveform Sequencing"](#), on page 181.

Remote command:

[:SOURce<hw>] :BB:ARbitrary:WSEgment:SEquence:SElect on page 726

Trigger Example

Displays an example of a multi-segment waveform. The currently enabled trigger and next segment mode are considered. After the instrument is switched on, the graph of the last loaded waveform is displayed.

Note: The curves plotted in this dialog box are textbook examples, "not measured" waveforms. They are intended to visualize the trigger and next segment settings more clearly.

Remote command:

n.a.

3.7.4 How to Create and Work with the Multi-Segment Waveform Files

This section provides step-by-step instructions on how to configure and use the multi-segment settings. The [Figure 3-17](#) shows the essential stages of multi-segment waveform configuration, together with the corresponding user interface dialogs and if applicable, the corresponding file extensions. Perform the necessary settings, enable the signal generation, and provide trigger signal.

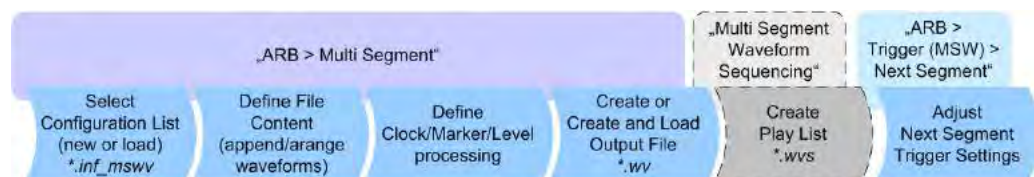

Figure 3-17: Basic workflow for generation of multi-segment waveforms

Generating a multi-segment waveform file (basic workflow)

1. In the "ARB > Create Multi Segment > General" dialog, select "New List" to create an empty list.
2. Use the "ARB: Multi Segment > Segment Table > Append" function to add two or more waveform files.
3. In the "ARB: Multi Segment > Level/Clock/Marker" dialog, adjust the "Level", "Clock", and "Segment Marker" settings.
4. Select the "ARB > Multi Segment > General > Output File" and enter filename.
5. Select "ARB > Multi Segment > General > Save List" to store the configuration file.
6. Select "ARB > Multi Segment > General > Create Output File" or "Create and Load Output File" to create and load the multi-segment waveform.
7. Select "ARB > Multi Segment > General > State > On".



The following description emphasizes on the settings required to fulfill the particular task or achieve the desired performance; standard basic settings are not discussed. All provided examples use the example segment sequence as shown on [Figure 3-18](#).

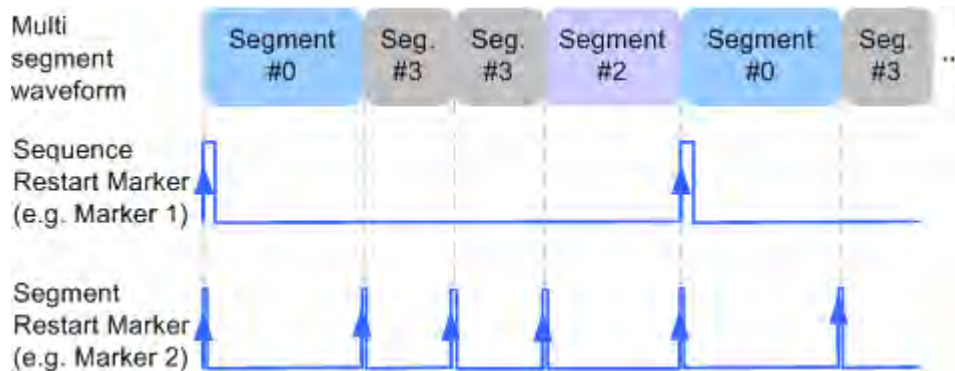

Figure 3-18: Example: multi-segment sequence with marker signals

See how to:

- ["To apply a manual segment switch to the output segments in the required order"](#) on page 190
- ["To generate a multi-segment signal without signal interruptions"](#) on page 191
- ["To enable an external triggering for high-speed switch over"](#) on page 192
- ["To configure a multi-segment sequence using the play list function"](#) on page 193
- ["To add marker signals"](#) on page 194

To apply a manual segment switch to the output segments in the required order

When testing DUTs using different test signals, it may be necessary to switch dynamically and flexibly between any of the test signals, for instance depending on the outcome of the previous test. The following settings enable flexible dynamic switch over between the segments in a multi-segment waveform.

We assume, that a multi-segment sequence composed of 4 segments (Seg#0, Seg#1, Seg#2 and Seg#3) is created and loaded in the ARB (see ["Generating a multi-segment waveform file \(basic workflow\)"](#) on page 189). The required output order of the segments is Seg#0, Seg#3 [2], Seg#2. The instrument is operated manually, the ARB generator is in active state, and the instrument output is switched on.

1. Select "ARB > Trigger In (MSW) > Next Segment Mode = Next Segment"
The transition between the segments is abrupt.
2. To enable manual next segment triggering, select "ARB > Trigger In (MSW) > Next Segment Source = Internal".
3. To enable manual triggering, select "ARB > Trigger In > Mode = Armed Auto".
Select "ARB > Trigger In > Source = Internal".
4. Execute "ARB > Trigger In > Execute Trigger" to trigger the signal generation.

The "ARB > Trigger In (MSW)" settings display the currently output segment: "Current Segment Name = Seg#0" and "Current Segment Index = 0". Seg#0 is output continuously.

- Set "ARB > Trigger In (MSW) > Segment = 3" to output the second segment in the sequence order.

The parameter "ARB > Trigger In (MSW) > Current Segment Index" changes to segment index 3. Seg#3 is output continuously.

- Execute "ARB > Trigger In > Execute Trigger" to restart Seg#3.
- Set "ARB > Trigger In (MSW) > Segment = 2" to output the third segment in the sequence order.

Seg#2 is output continuously.

To switch over to Seg#0, change the "ARB > Trigger In (MSW) > Current Segment Index", etc.

Tip: The ARB sequencer mode provides the necessary settings to achieve the same goal in a more convenient way, see ["To configure a multi-segment sequence using the play list function"](#) on page 193



Faster flexible dynamic switch over

When using **remote control** via an external computer, the following settings enable switching times of approx. 20 ms for segments with the same sample rate and approx. 200 ms for segments with different sample rates:

- "ARB > Trigger In (MSW) > Next Segment Mode = Next Segment"
- "ARB > Trigger In > Trigger Mode = Auto"
- "ARB > Trigger In > Trigger Source = Internal"

To generate a multi-segment signal without signal interruptions

Testing receivers requires a continuous output of different test signals without interrupting the signal. The test signals then produce a complex total signal with no signal gaps on switch over. Control procedures can use a simulated back channel of the receiver (trigger line or remote control).



Switching times depend on the length of the segment currently being output, because switch over to the next segment does not take place until the current segment ends.

To overcome wrap-around problems and generate multi-segment signals without signal gaps between the segments, consider the following settings:

- Enable "ARB > Trigger In (MSW) > Next Segment Mode = Next Segment Seamless"
- Select "ARB > Trigger In > Trigger Mode = Auto"
- Select "ARB > Trigger In > Trigger Source = Internal"

4. A segment ("Current Segment") is output continuously as long as the value of the parameter "Segment" is not changed. Change the value of the parameter "ARB > Trigger In (MSW) > Segment" to select the segment index processed after completing the current one.
5. The seamless transition between the segments requires waveforms with equal clock rate.
If the waveforms feature different sample rates, select "ARB > Multi Segment > Level/Clock/Marker > Clock Mode = Highest" or "Clock Mode = User" to resample the waveforms.

To enable an external triggering for high-speed switch over

To test DUTs/chips using different test signals at high throughput requires fast switch over (for instance when testing ATE devices during manufacture).

We assume, that the required multi-segment sequence is created and loaded in the ARB (see ["Generating a multi-segment waveform file \(basic workflow\)"](#) on page 189). The segments are *output in incremental order*. The instrument is operated manually, the ARB generator is in active state, and the instrument output is switched on. An external global or local trigger source is connected to the instrument and the corresponding connectors are configured.

The following settings enable **switching times of approx. 5 us** and the test signals are scrolled through with the aid of an external trigger signal:

1. Select "ARB > Trigger In (MSW) > Next Segment Mode = Next Segment".
2. Select "ARB > Trigger In (MSW) > Next Segment Source = External (NEXT)".
3. Do not change the displayed segment index (parameter "ARB > Trigger In (MSW) > Segment").
4. Enable "ARB > Trigger > Trigger Mode = Auto"
5. Select "ARB > Trigger > Trigger Source = External Global"
6. If the waveforms in the multi-segment file feature different sample rates, select "ARB > Multi Segment > Level/Clock/Marker > Clock Mode = Highest" or "Clock Mode = User" to resample the waveforms.

The switch over between the segments is triggered by receiving of an external trigger event. The segments are output in incremental order, i.e. Seg#0, Seg#1, etc. The currently processed segment ("Current Segment") is output continuously as long as a new trigger event is received. A new trigger event aborts the output of the current segment immediately and starts the processing of the next one in the sequence.

Tip: To output the segments in any order, use the ARB sequencer mode, see ["To configure a multi-segment sequence using the play list function"](#) on page 193. For general description on the configuration of the trigger and connector settings: See [Chapter 10.2, "Configuring the Global Connectors"](#), on page 486.

To configure a multi-segment sequence using the play list function



The ARB Sequencer mode requires waveform files with equal clock rate!

We assume, that a multi-segment sequence composed of four segments (Seg#0, Seg#1, Seg#2 and Seg#3) is created and loaded in the ARB (see ["To apply a manual segment switch to the output segments in the required order"](#) on page 190). The required output order of the segments is Seg#0, Seg#3 [2], Seg#2. The instrument is operated manually, the ARB generator is in active state, and the instrument output is switched on.

The following settings show an example of how to configure this segment output order with the help of the ARB sequencing function.

1. In the "ARB > Multi Segment" dialog, load the previously created list and execute "Create and Load".
2. Select "ARB > Multi Segment > General > Sequencing List".
The "Multi Segment Waveform Sequencing" dialog opens. A new play list is created and assigned to the current multi-segment waveform file.
3. Select "ARB: Multi Segment Waveform Sequencing > Sequencing Play List" and use the "Append" function to add new rows to the list and configure the settings as follows:
 - a) Id#0: Seg#0, "Rep. Cycles = 1", "Next = Next Id#"
 - b) Id#1: Seg#3, "Rep. Cycles = 2", "Next = Next Id#"
 - c) Id#2: Seg#2, "Rep. Cycles = 1", "Next =Goto Id", "Go To = 0" (creates a loop to the first segment in the sequence)

ARB: Multi Segment Waveform Sequencing - /var/user/ms_seq_list_3sgmts.wvs

Id#	State	Seg.#	Waveform	Rep. Cycles	Next	Go To	Info...
0	On	0	arb_sine.wv	1	Next Id#		Info...
1	On	1	arb_constIQ.wv	2	Next Id#		Info...
2	On	2	arb_rect.wv	1	Goto Id	0	Info...

Append Delete Shift Id# Up Down
 0 [1] 1 [2] 2 [1] Goto Id#0

4. Select "ARB: Multi Segment Waveform Sequencing > General > Save List" to store the configured play list.
5. To enable the instrument to use this play list, select "ARB > Trigger (MSW) > Next Segment Mode > Sequencer".
6. Select "ARB > Trigger (MSW) > Trigger Mode = Armed Auto"
7. Select "ARB > Trigger (MSW) > Trigger Source = Internal"

The segments are played back (output) as defined in the sequencing list, i.e. the switch over to the next segment is performed automatically according to the rules and segment order defined in the "Sequencing Play List".

To add marker signals

We assume, that a multi-segment sequence composed of the segments Seg#0 [1], Seg#3 [2], Seg#2 [1] is created and loaded in the ARB (see ["To configure a multi-segment sequence using the play list function"](#) on page 193). The multi-segment sequence starts with Seg#0 and this segment is output once. The instrument is operated manually, the ARB generator is in active state, and the instrument output is switched on.

To add marker signals at the beginning of each segment and at the beginning of the sequence (see [Figure 3-18](#)), two additional marker signals, "Marker 2" and "Marker 1", are enabled and inserted into the multi-segment waveform.

1. Select "ARB > Marker > Marker Mode > Marker 1/Marker2 = Unchanged" to enable taking over of the marker signals defined inside the multi-segment sequence. If necessary, adjust the marker delay settings.
2. Select the "Block Diagram > Trigger/Marker/Clock" and map the "Logical Signals > Marker 1/Marker 2" to the desired connectors ("Global Connectors > User x > Direction = Output" and "Signal = Baseband Marker 1/Baseband Marker 2")
3. In the "ARB > Multi Segment > Level/Clock/Marker" dialog, select "Segment Marker = Ignore"
4. Enable "Level/Clock/Marker > Sequence Restart = Marker 1"
5. Enable "Level/Clock/Marker > Segment Restart = Marker 2"

An extra restart marker signal is generated at the beginning of each segment and the beginning of the waveform. These restart markers *overwrite* the existing Marker 1 and Marker 2 trace signals defined in the waveforms of the individual segments.

3.7.5 Reference to Triggering of Multi-Segment Waveforms

Signal generation of multi-segment waveforms takes place differently according to the trigger selected in the "ARB > Trigger In" section. The sections provide a detailed explanation of the effect of a trigger event on the multi-segment waveform processing, depending on the enabled "Next Trigger Mode". Refer to [Chapter 3.7.2.5, "Impact of the Trigger Settings and Next Segment Settings"](#), on page 170 for background information.

3.7.5.1 Triggering in "Next Trigger Mode = Same Segment"

Depending on the trigger setting, the currently selected segment is continuously output either immediately or after a trigger event.

Table 3-16: Waveform triggering: "Next Trigger Mode = Same Segment", "Trigger Source = Internal"

"Trigger Mode"	Description
"Auto"	Output starts at once and the segment is generated continuously. Trigger events are ignored. If the segment is changed in "Segment", output of the current segment is stopped and the new segment is output immediately, following a system-imposed signal gap.
"Armed_Auto"	Output starts after the first trigger event. The segment is then generated continuously. Further trigger events are ignored. If the segment is changed in "Segment", signal output is stopped and the new segment is not output until a trigger occurs.
"Retrigger"	Output starts at once and the segment is generated continuously, a trigger event causes a restart. If the segment is changed in "Segment", output of the current segment is stopped and the new segment is output immediately, following a system-imposed signal gap.
"Armed_Retrigger"	Output starts after the first trigger event. The segment is then generated continuously. Further trigger events cause a restart. If the segment is changed in "Segment", signal output is stopped and the new segment is not output until a trigger occurs.
"Single"	Output starts after the first trigger event. The segment is then generated once. Further trigger events cause a restart. If the segment is changed in "Segment", signal output is not stopped. The new segment is not output until a trigger occurs.

3.7.5.2 Triggering in "Next Trigger Mode = Next Segment"

Depending on the trigger setting, the segment selected under "Segment" is output either immediately or after a trigger event. If the segment index is changed in "Segment", the new segment is not output until a trigger occurs.

Table 3-17: Waveform triggering: "Next Trigger Mode = Next Segment", "Trigger Source = Internal"

"Trigger Mode"	Description
"Auto"	Output starts at once and the segment is generated continuously. If the segment index is changed in "Segment", output of the current segment is stopped and the new segment is output immediately, following a system-imposed signal gap.
"Armed_Auto"	Output starts after the first trigger event. The segment is then generated continuously. If the segment index is changed in "Segment", output of the current segment is stopped and the new segment is output immediately, following a system-imposed signal gap.
"Single"	Output starts after the first trigger event. The segment is then generated once. Further trigger events cause a restart. If the segment index is changed in "Segment", the new segment is not output until a trigger occurs.

Table 3-18: Waveform triggering: "Next Trigger Mode = Next Segment", "Trigger Source = External"

"Trigger Mode"	Description
"Auto"	Output starts at once and the segment is generated continuously. Further trigger events are ignored. Each next segment trigger event switches over to outputting the subsequent segment, following a system-imposed signal gap. If the segment index is changed in "Segment", output of the current segment is stopped and the new segment is output immediately, following a system-imposed signal gap. The subsequent trigger event after the last segment causes the first segment to be output again.
"Armed_Auto"	Output starts after the first trigger event. The segment is then generated continuously. Further trigger events are ignored. Each next segment trigger event switches over to outputting the subsequent segment, following a system-imposed signal gap. If the segment is changed in "Segment", signal output is stopped and the new segment is not output until a trigger occurs. The subsequent trigger event after the last segment causes the first segment to be output again.
"Single"	Output starts after the first trigger event. The segment is then generated once. Each trigger event (re-) starts the segment; each next segment trigger event switches over to outputting the subsequent segment. If the segment is changed in "Segment", signal output is not stopped. The new segment is not output until a trigger occurs. The subsequent trigger event after the last segment causes the first segment to be output again.

For description of the "Retrigger" and "Armed_Retrigger" trigger modes, see [Table 3-16](#).

3.7.5.3 Triggering in "Next Trigger Mode = Next Segment Seamless"

The segment selected under "Segment" is output. This mode is only available if all segments have the same sample rate.

Table 3-19: Waveform triggering: "Next Trigger Mode = Next Segment Seamless", "Trigger Source = Internal"

"Trigger Mode"	Description
"Auto"	Output starts at once and the segment is generated continuously. If the segment is changed in "Segment", the new segment is output seamlessly after the output of the current segment is complete.
"Armed_Auto"	Output starts after the first trigger event. The segment is then generated continuously. If the segment is changed in "Segment", signal output is stopped and the new segment is not output until a trigger occurs.
"Single"	Output starts at once and the segment is generated continuously. Each trigger event (re-) starts the segment; each next segment trigger event switches over to outputting the subsequent segment once the output of the current segment has been completed. If the segment is changed in "Segment", the new segment is output seamlessly after the output of the current segment is complete.

Table 3-20: Waveform triggering: "Next Trigger Mode = Next Segment Seamless", "Trigger Source = External"

"Trigger Mode"	Description
"Armed_Auto"	Output starts after the first trigger event. The segment is then generated continuously. Each trigger event (re-) starts the segment; each next segment trigger event switches over to outputting the subsequent segment once the output of the current segment has been completed. If the segment is changed in "Segment", signal output is stopped and the new segment is not output until a trigger occurs.

For description of the "Retrigger" and "Armed_Retrigger" trigger modes, see [Table 3-16](#).

3.7.5.4 Triggering in "Next Trigger Mode = Sequencer"

The waveform files are processed according to the order and repetition cycles defined in the special sequencing list file (*.wvs) assigned to the multi-segment waveform file.

3.8 Generating Multi-Carrier Signals

To simulate complex multi-carrier scenarios with different baseband signals, the R&S SMBV100B provides the possibility to generate multi-carrier waveforms. These waveforms can consist of up to 512 carriers, each modulated by the same or by different user-selectable baseband signal.

The multi-carrier waveform is a practical solution for the generation of a complex broadband signal, for example:

- Multi-carrier waveforms build from the signals *of different* communication standards (e.g. CDMA2000 or 3GPP FDD)

- Multi-carrier waveforms composed of several signals from *the same* communication standard as in LTE Advanced.

3.8.1 Required Options

See [Chapter 3.6.1, "Required Options"](#), on page 145.

Multi-carrier waveform files require the corresponding Digital Standard options (R&S SMBV100B-K2xx) of all included standards.

3.8.2 About the Multi-Carrier Waveforms

This chapter provides background information on the ARB functionality for generating multicarrier signals and the impact of the provided settings. Refer to [Chapter 3.8.4, "How to Use the Multi-Carrier Function"](#), on page 212 for information on how to use the provided settings to configure a multicarrier signal.

The multi-carrier waveforms are convenient way to configure the broadband test signals required for transmitter or receiver tests. Even complex multi-carrier scenarios composed of signals from different digital standards can be created and used for these tests.

Because the multi-carrier files are processed by the ARB generator, the composed waveform file must be created before it is loaded to and played by the ARB. The R&S SMBV100B stores the created multi-carrier waveform file under user definable name; as with the single carrier waveforms, the used file extension is *.wv. The instrument appends additional information to the header of the composed waveform file. When the created waveform is loaded, the graphical interface displays information on clock rate, number of samples and creation day.

General principle for composing the multicarrier signal

The following is a list of the general steps used for composing the multicarrier signal:

- In the default mode, the up to 512 carriers are equally spaced and centered toward the RF frequency or the baseband DC line.
The carrier spacing is adjustable within the total available bandwidth. The total RF bandwidth of the composed multicarrier signal may not exceed the available RF bandwidth (see data sheet).
- Another possibility is to define the center frequency of each of the carrier individually, see also [Chapter 3.8.2.1, "Defining the Carrier Frequency"](#), on page 199.
- Each carrier can be separately defined in terms of power, phase and modulated input signal.
To define the leveling of the composed multicarrier signal, use the parameter [Power Reference](#)
- Optionally, crest factor optimization can be applied (see [Chapter 3.8.2.2, "Optimizing the Crest Factor"](#), on page 199).

- After all multi-carrier processing steps are completed, the instrument calculates the resulting peak and RMS power over the total signal. This value is then written in the waveform file.

3.8.2.1 Defining the Carrier Frequency

There are two ways to define the carrier frequency of the individual carriers in the multicarrier signal:

- Enabling the **arbitrary carrier frequency** distribution and specifying the carrier frequency of each carrier individually.
- Using the built-in **equidistant carrier spacing** distribution function. That is, enabling the carriers to be equally spaced and centered toward the RF frequency. The carrier frequencies are automatically calculated depending on the selected number of carriers and the carrier spacing.

The maximum carrier spacing is a function of the available total bandwidth and the selected number of carriers. It is calculated as follows:

$$\text{Max Carrier Spacing} = \text{Total bandwidth} / (\text{Number of Carriers} - 1)$$

To avoid wrap-around problems, the effective applied carrier spacing can be slightly modified.

The value of the carrier spacing is rounded in that way that the carrier closest to the center RF frequency shows no phase jump. It is assumed that the carrier is unmodulated.

- For odd number of carriers:

$$\text{RoundedCarrierSpacing} = 1 / \text{OutputSignalDuration} * \text{round}(\text{CarrierSpacing} * \text{OutputSignalDuration})$$

- For even number of carriers:

$$\text{RoundedCarrierSpacing} = 2 / \text{OutputSignalDuration} * \text{round}(0.5 * \text{CarrierSpacing} * \text{OutputSignalDuration})$$

The R&S SMBV100B provides the parameter **Mode** for this purpose.

3.8.2.2 Optimizing the Crest Factor

An introduction to the topic is provided in [Chapter 3.4.1.7, "Methods for Optimizing the Crest Factor"](#), on page 107. This section focuses on the settings provided for and related to the multicarrier signals.

The R&S SMBV100B provides a crest factor reduction in form of an automatic optimization upon selected values for the following parameters:

- **Crest factor optimization mode:** determines whether the phase settings are selectable or internally calculated to fulfill a requirement for the crest factor value.
- **Clipping:** reduces the peak power of the resulting multicarrier signal according to the input parameter "Target Crest Factor"
The resulting clipped peak power is the sum of the RMS level of the unclipped multicarrier signal and the parameter "Target Crest Factor".
Because clipping reduces also the RMS level, the resulting crest factor of the clipped signal is slightly above the "Target Crest Factor".

- **Target Crest Factor:** determines the Target Crest Factor. A value above the crest factor of the unclipped multicarrier signal has no effect.
- **Filter cutoff frequency:** determines the filter parameter of the final lowpass filter. When the cutoff frequency is set as half of the output sample rate, a final lowpass filter improves the spectrum of the clipped multicarrier signal. However, it can also increase the resulting crest factor.

3.8.3 Multi-Carrier Settings

Access:

- ▶ Select "Baseband > ARB > General > Create Multi Carrier".

The "ARB: Multi Carrier" dialog enables direct configuration of the carrier distribution around the center frequency and adjusting some parameters for improving the signal characteristics.

The dialog is divided into several tabs. In each case, the current setting is displayed in the tab name. The tab "Carrier Table" enables the selection of the waveform files to be processed. Use the "Carrier Graph" to visualize the configured signal.

The remote commands required to define these settings are described in [Chapter 12.16.4.3, "SOURce:BB:ARbitrary Subsystem"](#), on page 707.

Settings:

- [General Settings](#)..... 200
- [Carrier Table Settings](#).....207
- [Carrier Table Assistant](#).....209
- [Carrier Graph](#)..... 211

3.8.3.1 General Settings

Access:

- ▶ Select "Baseband > ARB > General > Create Multi Carrier".

This tab comprises settings for selecting the output waveform file, enabling the generation, and the configuration of the carrier distribution.

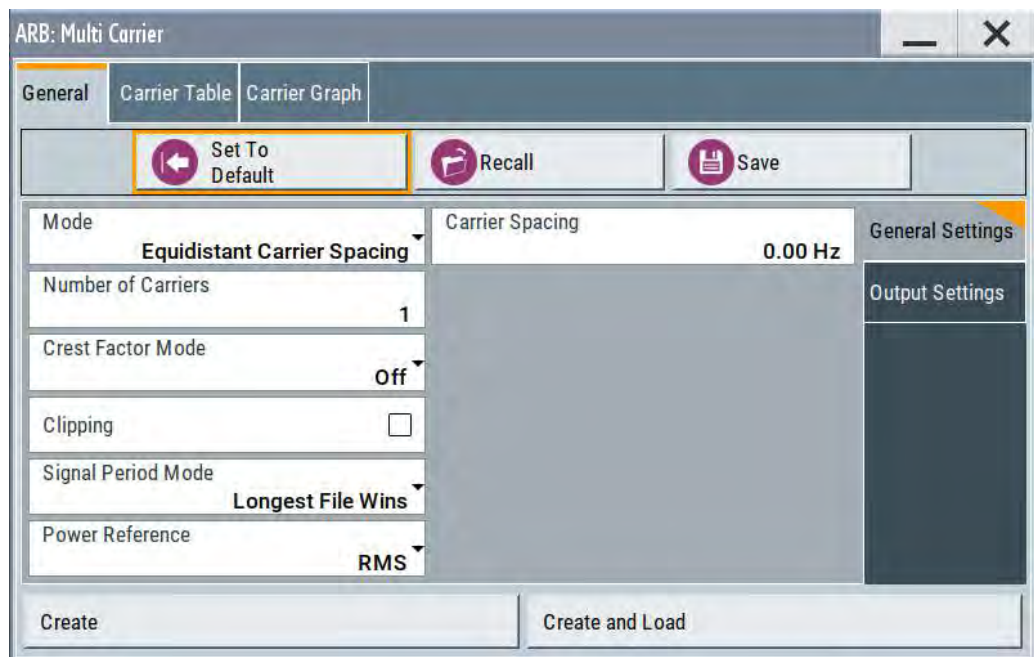

Settings:

Set to Default..... 201

Save/Recall Frame.....202

Mode..... 202

Number of Carriers.....202

Carrier Spacing..... 202

Crest Factor Mode..... 203

Clipping..... 203

Target Crest Factor..... 203

Filter Cutoff Frequency.....203

Signal Period Mode.....203

Signal Period.....204

Power Reference..... 204

Output Settings..... 205

 L Output File..... 206

 L Clock Rate..... 206

 L File Size..... 206

Create/Create and Load.....206

Set to Default

Calls the default settings.

Parameter	Value
Number of Carriers	1
Carrier Spacing	0 MHz
Crest Factor Mode	Off
Signal Period Mode	Longest file wins

Remote command:

`[:SOURce<hw>] :BB:ARBitrary:MCARrier:PRESet` on page 733

Save/Recall Frame

Accesses the standard "Save/Recall" dialog, i.e. the standard instrument function for storing and recalling the complete dialog-related settings. Refer to [Chapter 9.4, "Saving and Recalling Instrument Settings"](#), on page 451 for a detailed description.

The multi-carrier settings are stored as files with the predefined file extension `*.arb_multcarr`. The filename and the directory they are stored in are user-definable.

Remote command:

`[:SOURce<hw>] :BB:ARBitrary:MCARrier:SETTing:CATalog?` on page 733

`[:SOURce<hw>] :BB:ARBitrary:MCARrier:SETTing:LOAD` on page 733

`[:SOURce<hw>] :BB:ARBitrary:MCARrier:SETTing:STORe` on page 734

Mode

Selects the way the carriers are distributed within the available bandwidth.

"Equidistant Carrier Spacing"

Sets an equidistant carrier spacing distribution, i.e. the carriers are equally spaced and centered toward the RF frequency. The carrier frequencies are automatically calculated depending on the selected number of carriers and the carrier spacing.

"Arbitrary Carrier Frequency"

Enables the specification of the carrier frequency of each carrier individually.

Remote command:

`[:SOURce<hw>] :BB:ARBitrary:MCARrier:CARRier:MODE` on page 734

Number of Carriers

Sets the number of carriers for the multi-carrier waveform. By default the multi-carrier table lists one carrier. A maximum of 512 carriers can be configured and activated.

When the number of carriers is increased, new lines are added at the end of the table. If these carriers already have been defined before, the settings are preset according to the former settings. Otherwise the parameters are preset with the default values.

See also [Chapter 3.8.2.1, "Defining the Carrier Frequency"](#), on page 199.

Remote command:

`[:SOURce<hw>] :BB:ARBitrary:MCARrier:CARRier:COUNT` on page 734

Carrier Spacing

Sets the frequency spacing between adjacent carriers of the multi-carrier waveform.

The carriers are arranged symmetrically around the RF carrier and the maximum carrier spacing is limited to:

"Carrier Spacing" = Baseband bandwidth / ("Number of Carriers" - 1).

The baseband bandwidth depends on the installed options (see the data sheet).

For more information, see [Chapter 3.8.2.1, "Defining the Carrier Frequency"](#), on page 199.

Remote command:

`[:SOURce<hw>] :BB:ARbitrary:MCARrier:CARRier:SPACing` on page 734

Crest Factor Mode

Selects the mode for optimizing the crest factor by calculating the carrier phases. For more information, refer to [Chapter 3.8.2.2, "Optimizing the Crest Factor"](#), on page 199.

The following modes are available:

- | | |
|------------|--|
| "Off" | There is no automatic setting for minimizing or maximizing the crest factor. The "Phase" setting as defined in the carrier table is in use. |
| "Minimize" | The crest factor is minimized by internally calculating optimized carrier phases. The phase setting displayed in the carrier table is invalid. |
| "Maximize" | The crest factor is maximized by internally calculating optimized carrier phases. The phase setting displayed in the carrier table is invalid. |

Remote command:

`[:SOURce<hw>] :BB:ARbitrary:MCARrier:CFACTOR:MODE` on page 735

Clipping

Switches the baseband clipping on and off.

Clipping reduces the peak power of the resulting multicarrier signal according to the input parameter "Target Crest Factor". For more information, refer to [Chapter 3.8.2.2, "Optimizing the Crest Factor"](#), on page 199.

Remote command:

`[:SOURce<hw>] :BB:ARbitrary:MCARrier:CLIPping[:STATe]` on page 736

Target Crest Factor

Sets the value of the target crest factor, if baseband clipping is enabled.

A "Target Crest Factor" above the crest factor of the unclipped multicarrier signal has no effect. For more information, refer to [Chapter 3.8.2.2, "Optimizing the Crest Factor"](#), on page 199.

Remote command:

`[:SOURce<hw>] :BB:ARbitrary:MCARrier:CLIPping:CFACTOR` on page 736

Filter Cutoff Frequency

Sets the cutoff frequency of the final lowpass filter, if baseband clipping is enabled.

When the cutoff frequency is set as half of the output sample rate, a final lowpass filter improves the spectrum of the clipped multicarrier signal. This process can increase the resulting crest factor. See also [Chapter 3.8.2.2, "Optimizing the Crest Factor"](#), on page 199.

Remote command:

`[:SOURce<hw>] :BB:ARbitrary:MCARrier:CLIPping:CUTOFF` on page 736

Signal Period Mode

Defines the way the resulting signal period of the multi-carrier waveform is calculated. The resulting period is always calculated for all carriers in the carrier table irrespective of their state (ON/OFF). Use the "Carrier Table > Info" function to obtain information on the sample rate and file length data of each carrier.

Note: Wrap-around and timing problems can occur when I/Q signals of different length are used. Thus, demodulation of a carrier can be difficult or even impossible.

We recommend that you proceed as follows:

- Consider the timing when creating the input I/Q files.
- Adjust the signal duration to the carrier which is then demodulated.
(In this case, the other carriers are for interfering the signal only.)

These problems do not arise with signals of the same standard (e.g. 3GPP).

The following modes are available:

"Longest File Wins"

The longest I/Q file in the carrier table defines the resulting signal period. Shorter I/Q files are periodically repeated.

"Shortest File Wins"

The shortest I/Q file in the carrier table defines the resulting signal period. Only the first part of longer I/Q files is used.

"User"

The signal period is set manually ([Signal Period](#)). Shorter I/Q files are repeated periodically, and only the first part of longer I/Q files is used.

"Least Common Multiple"

The output file duration is the least common multiple of all input file durations.

Remote command:

`[:SOURCE<hw>] :BB:ARbitrary:MCARrier:TIME:MODE` on page 737

Signal Period

Sets the signal period in Signal Duration Mode "User". Shorter I/Q files are repeated periodically, and only the first part of longer I/Q files is used.

Remote command:

`[:SOURCE<hw>] :BB:ARbitrary:MCARrier:TIME` on page 735

Power Reference

Defines the way the individual carriers in a composed multi carrier signal are leveled. The difference between the provided modes is especially important if signals with different crest factors are composed together into a multi carrier signal.

"RMS" The individual carriers are leveled based on their RMS power and the configured "Carrier Gain".

Example:

A multi carrier signal is composed from two waveform files.

First carrier "Gain" = 0 dB

Second carrier "Gain" = -3 dB

In the resulting multi carrier signal, the *RMS power* of the second carrier signal will be 3 dB lower than the *RMS power* of the first carrier signal.

"Peak" The individual carriers are leveled based on their peak power and the configured "Carrier Gain".

Example:

A multi carrier signal is composed from two waveform files.

First carrier "Gain" = 0 dB

Second carrier "Gain" = -3 dB

In the resulting multi carrier signal, the *peak power* of the second carrier signal will be 3 dB lower than the peak power of the first carrier signal.

Example: Multi carrier signal composed of waveforms with different crest factor

A multi carrier signal is composed from two waveform files with the following characteristics:

3GPP FDD signals with the same "Sample Rate" but *different "Crest Factors"*.

"Peak" = 0 dBFS

"Carrier Gain" = 0 dB

State	Carrier Freq. Offs. / MHz	Gain / dB	Phase / deg	Delay / ns	File	Info	!!!
0 On	-5.000 000	0.00	0.00	0	/var/user/ite1	Info...	
1 On	5.000 000	0.00	0.00	0	/var/user/ite2	Info...	

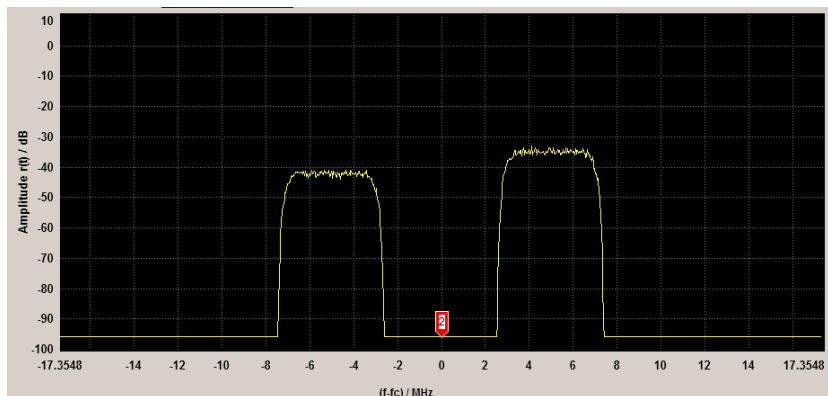

The Peak values of the carrier signals are equal, the RMS values are different.

Remote command:

`[:SOURCE<hw>] :BB:ARbitrary:MCARrier:POWER:REFERENCE` on page 737

Output Settings

The output settings indicate the name, the file size, and the clock rate of the currently calculated multi-carrier output file.

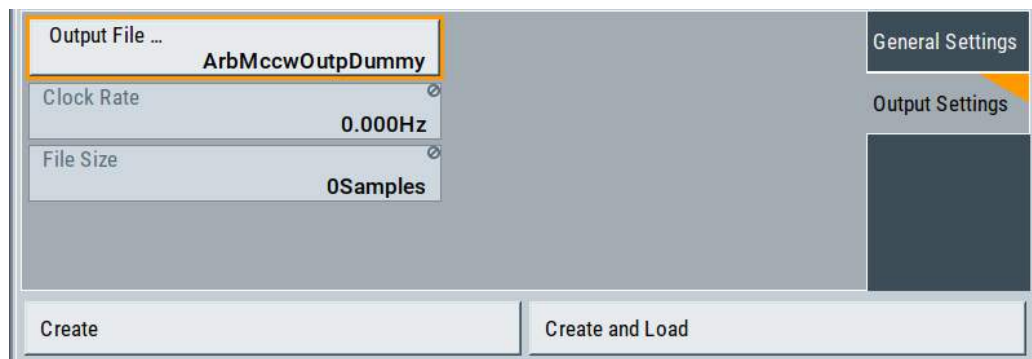

Output File ← Output Settings

Accesses the standard "File Select" function to specify the output filename of the multi-carrier waveform to be calculated. As with normal waveforms, the file extension is *.wv.

To trigger the calculation and storage of this multi-carrier waveform, select "Create" or "Create and Load".

Remote command:

[\[:SOURCE<hw>\]:BB:ARbitrary:MCARrier:OFILe](#) on page 737

Clock Rate ← Output Settings

Displays the resulting sample rate at which the multi-carrier waveform is output by the ARB generator.

The output clock rate depends on the following:

- Number of carriers
- Carrier spacing
- Input sample rate of the leftmost or rightmost carriers.

Remote command:

[\[:SOURCE<hw>\]:BB:ARbitrary:MCARrier:CLOCK?](#) on page 738

File Size ← Output Settings

Displays the resulting number of samples of the multi-carrier waveform.

Remote command:

[\[:SOURCE<hw>\]:BB:ARbitrary:MCARrier:SAMPles?](#) on page 735

Create/Create and Load

Creates a multi-carrier waveform defined by the multi-carrier table and general setting entries.

If you start calculation with the "Create and Load" function, the instrument creates the waveform and loads it in the ARB generator.

This multi-carrier waveform is stored with filename specified in "Output File". Depending on the configuration of the multi-carrier waveform, calculation can take some time. To stop the calculation, use the "Abort" function.

Remote command:

[\[:SOURCE<hw>\]:BB:ARbitrary:MCARrier:CREate](#) on page 738

[\[:SOURCE<hw>\]:BB:ARbitrary:MCARrier:CLOad](#) on page 737

3.8.3.2 Carrier Table Settings

Access:

1. Select "Baseband > ARB > General > Multi Carrier".
2. Select "ARB: Multi Carrier > Carrier Table"



This tab comprises the settings of the individual carriers. A selectable carrier range can be set with the aid of the optional "Carrier Table Assistant".

The settings of all available carriers are displayed in table form. Previously applied assistant settings can be further refined. The number of lines corresponds to the number of carriers.



The phase/deg settings are only valid if optimization of the crest factor is disabled ("Crest Factor Mode" = Off).

Use the "Carrier Graph" tab to visualize the selected multi-carrier configuration.

Settings:

Number of Carriers.....	208
No.....	208
State.....	208
Carrier Freq [MHz].....	208
Gain.....	208
Phase.....	208
Delay.....	208
File.....	208
Info.....	209
!!!.....	209

Number of Carriers

Defines the number of carriers of the multi-carrier waveform.

This parameter is identical to the one in the "General Setting" section.

Remote command:

`[:SOURce<hw>] :BB:ARbitrary:MCARrier:CARRier:COUNT` on page 734

No

Indicates the carrier index ranging from 0 to (number of carriers -1).

Remote command:

Individual carriers are set by the index at the keyword `CARR`

State

Switches On/Off a carrier.

Remote command:

`[:SOURce<hw>] :BB:ARbitrary:MCARrier:CARRier<ch>:STATe` on page 738

Carrier Freq [MHz]

Sets the carrier frequency.

Note: The carrier frequency can only be set in "Arbitrary Carrier frequency" mode. For "Equidistant Carrier Spacing", the carrier spacing is determined automatically.

Remote command:

`[:SOURce<hw>] :BB:ARbitrary:MCARrier:CARRier<ch>:FREQuency`
on page 739

Gain

Sets the gain of a carrier.

Remote command:

`[:SOURce<hw>] :BB:ARbitrary:MCARrier:CARRier<ch>:POWer` on page 739

Phase

Sets the starting phase of a carrier.

Remote command:

`[:SOURce<hw>] :BB:ARbitrary:MCARrier:CARRier<ch>:PHASe` on page 739

Delay

Sets the starting delay of a carrier.

Remote command:

`[:SOURce<hw>] :BB:ARbitrary:MCARrier:CARRier<ch>:DELay` on page 740

File

Accesses the standard "File Select" function for selecting the input file. The input file contains the I/Q signal that is modulated onto the carrier.

Remote command:

`[:SOURce<hw>] :BB:ARbitrary:MCARrier:CARRier<ch>:FILE` on page 740

Info

Indicates the sample rate, number of I/Q value pairs (number of samples), and the signal period of the selected file.

Remote command:

n.a.

!!!

Indicates an occurred conflict by means of a warning triangle. A conflict arises when the carriers overlap and is also indicated in the header of the "Carrier Table" tab.

Remote command:

`[:SOURce<hw>] :BB:ARbitrary:MCARrier:CARRier<ch>:CONFLICT?`
on page 740

3.8.3.3 Carrier Table Assistant

Access:

1. Select "Baseband > ARB > General > Multi Carrier".
2. Select "ARB: Multi Carrier > Carrier Table > Carrier Table Assistant"

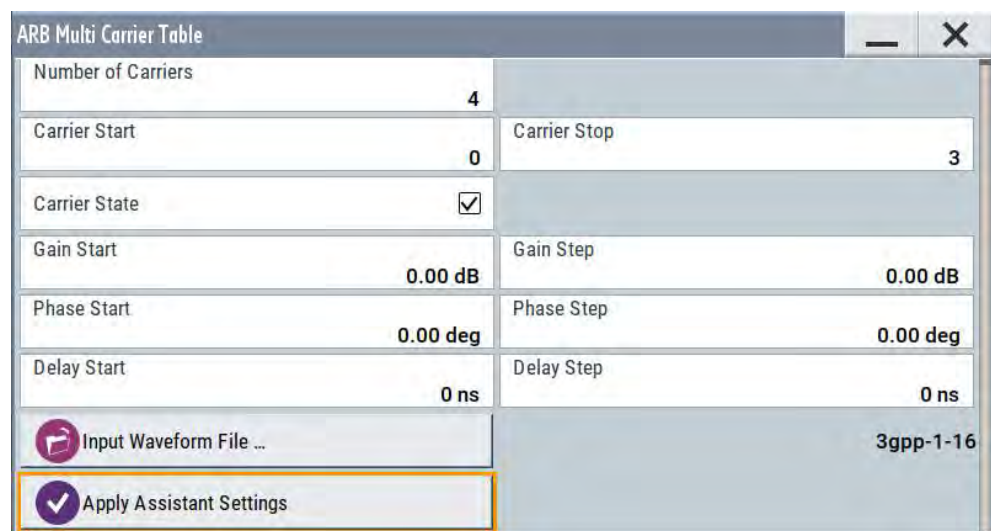

The "Carrier Table Assistant" dialog enables the configuration of a selectable subset of carrier. The provided settings are an optional way to create a multi-carrier scenario within a specified carrier range.

Settings:

Carrier State.....	210
Carrier Start/Start.....	210
Gain Start.....	210
Gain Step.....	210
Phase Start.....	210
Phase Step.....	210

Delay Start.....	211
Delay Step.....	211
Input Waveform File.....	211
Apply Assistant Settings.....	211

Carrier State

Switches the carriers in the range "Carrier Start" to "Carrier Stop" on/off.

Remote command:

`[:SOURCE<hw>] :BB:ARbitrary:MCARrier:EDIT:CARRier:STATe` on page 740

Carrier Start/Start

Defines the start/stop index of the carrier range to which the assistant settings are intended to apply.

Remote command:

`[:SOURCE<hw>] :BB:ARbitrary:MCARrier:EDIT:CARRier:START` on page 741

`[:SOURCE<hw>] :BB:ARbitrary:MCARrier:EDIT:CARRier:STOP` on page 741

Gain Start

Sets the gain of the carrier marked by "Carrier Start".

Remote command:

`[:SOURCE<hw>] :BB:ARbitrary:MCARrier:EDIT:CARRier:POWer [:START]`

on page 741

Gain Step

Sets the step width that is used to increment the gain.

The resulting carrier gain in the carrier table equals:

$$\text{Gain} = \text{"Gain Start"} + n * \text{"Gain Step"}$$

Where n is a value between 0 and ("Carrier Stop" - "Carrier Start").

Remote command:

`[:SOURCE<hw>] :BB:ARbitrary:MCARrier:EDIT:CARRier:POWer:STEP`

on page 741

Phase Start

Sets the phase of the carrier marked by "Carrier Start".

Remote command:

`[:SOURCE<hw>] :BB:ARbitrary:MCARrier:EDIT:CARRier:PHASe [:START]`

on page 742

Phase Step

Sets the step width that is used to increment the phase.

The resulting phase in the carrier table equals:

$$\text{Phase} = \text{"Phase Start"} + n * \text{"Phase Step"}$$

Where n is a value between 0 and ("Carrier Stop" - "Carrier Start").

Remote command:

`[:SOURCE<hw>] :BB:ARbitrary:MCARrier:EDIT:CARRier:POWer:STEP`

on page 741

Delay Start

Sets the delay of the carrier marked by "Carrier Start".

Remote command:

```
[ :SOURce<hw> ] :BB:ARbitrary:MCARrier:EDIT:CARRier:DElay[:STArT]
```

on page 743

Delay Step

Sets the step width that is used to increment the delay

The resulting delay in the carrier table equals:

$$\text{Delay} = \text{"Delay Start"} + n * \text{"Delay Step"},$$

Where n is a value between 0 and ("Carrier Stop" - "Carrier Start").

Remote command:

```
[ :SOURce<hw> ] :BB:ARbitrary:MCARrier:EDIT:CARRier:DElay:STEP
```

on page 742

Input Waveform File

Accesses the standard "File Select" function for selecting the input file. The input file contains the I/Q signal to be modulated onto *all carriers* of the selected carrier range.

Remote command:

```
[ :SOURce<hw> ] :BB:ARbitrary:MCARrier:EDIT:CARRier:FILE on page 743
```

Apply Assistant Settings

Transfers the assistant settings to the carrier table.

Remote command:

```
[ :SOURce<hw> ] :BB:ARbitrary:MCARrier:EDIT:CARRier:EXECute
```

on page 743

3.8.3.4 Carrier Graph

Access:

1. Select "Baseband > ARB > General > Multi Carrier".

2. Select "ARB: Multi Carrier > Carrier Graph"

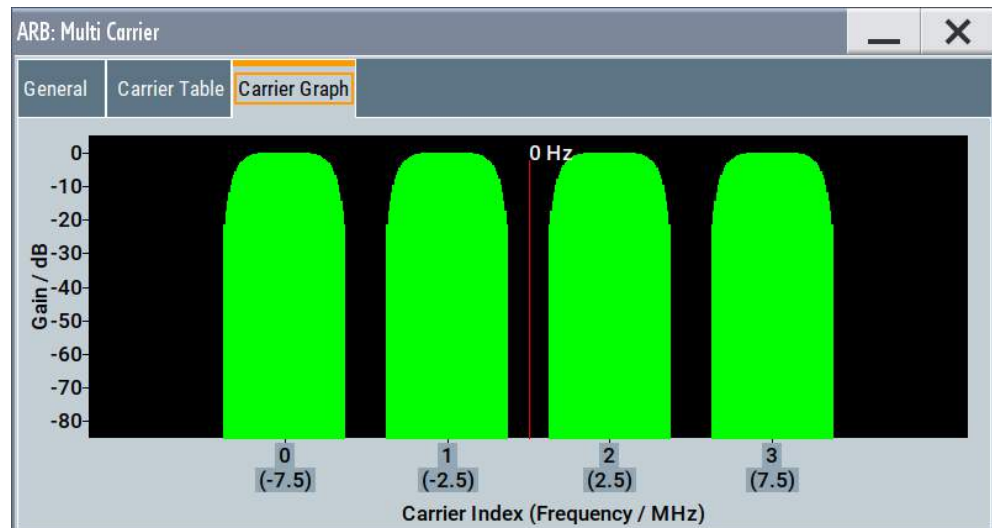

The carrier graph is a graphical representation of the current multi-carrier configuration in the frequency domain.

The height of the bars corresponds to the gain of each individual carrier. The bars width indicates the bandwidth of the carriers signals.

3.8.4 How to Use the Multi-Carrier Function

This section provides step-by-step instructions on how to configure and use the multi-carrier settings.

To create a multi-carrier waveform file (general workflow)

Perform the following general steps:

1. To configure the general settings, select "Baseband > ARB > General"
2. To configure the carrier table select "ARB > Multi Carrier > Carrier Table"
3. To enter the filename of the multi-carrier waveform, select "ARB > Multi Carrier > Output File"
4. To save and load multi-carrier waveform, select "ARB > Multi Carrier > Create or Create and Load")

To generate a multicarrier signal for standard transmitter test

High power amplifiers of multi-carrier base stations face increased requirements in terms of linearity and acceptable intermodulation performance.

To set up a standard transmitter test, proceed as follows:

1. Open the "Baseband > 3GPP FDD" dialog. Perform the following:
 - a) select "3GPP FDD > Basestations > Test Setups/Models"
 - b) select "3GPP FDD: Downlink/Test Model > Test_Model_1_16channels".

- c) Confirm with "Select".
2. To enable signal generation, select "3GPP FDD > General > ON".
3. To create a 3GPP ARB file, select "3GPP FDD > Generate Waveform".
Enter the name of the waveform file to be generated, for example 3gpp_1_16.
4. Confirm with "Save"
5. To set up a multi-carrier scenario with 4 carriers and a carrier spacing of 5 MHz, select "Baseband > ARB > Multi Carrier".
Perform the following:
 - a) In the "General" dialog, select "Number of Carriers = 4" and "Carrier Spacing = 5 MHz".
 - b) To load the generated waveform file to all 4 carriers, select "Carrier Table > Carrier Table Assistant". Select "Carrier Start = 0" and "Carrier Stop = 3".
 - c) To load the generated waveform file to all 4 carriers, select "ARB Multi Carrier Table > Input Waveform File". Navigate to the generated waveform file 3gpp_1_16 and select it.
 - d) Select "ARB Multi Carrier Table > Carrier State > On".

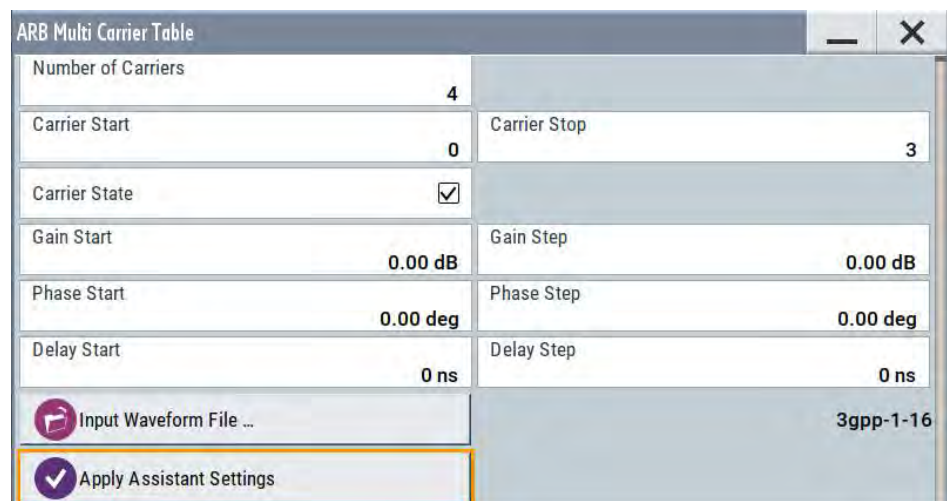

- e) Select "ARB Multi Carrier Table > Apply Assistant Settings". Close the dialog.
The "ARB: Multi Carrier > Carrier Table" dialog confirms the configuration.

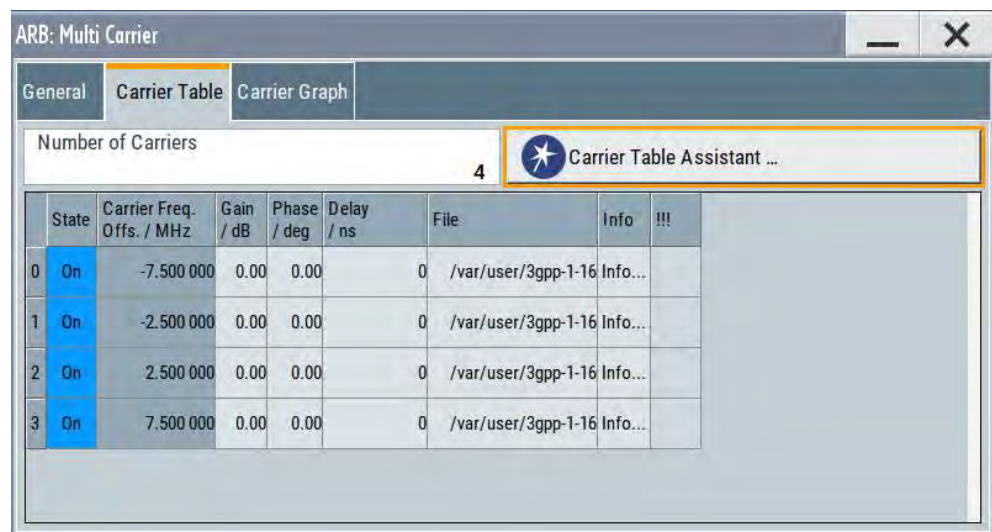

6. Select "ARB: Multi Carrier > Carrier Graph" to visualize the configuration.

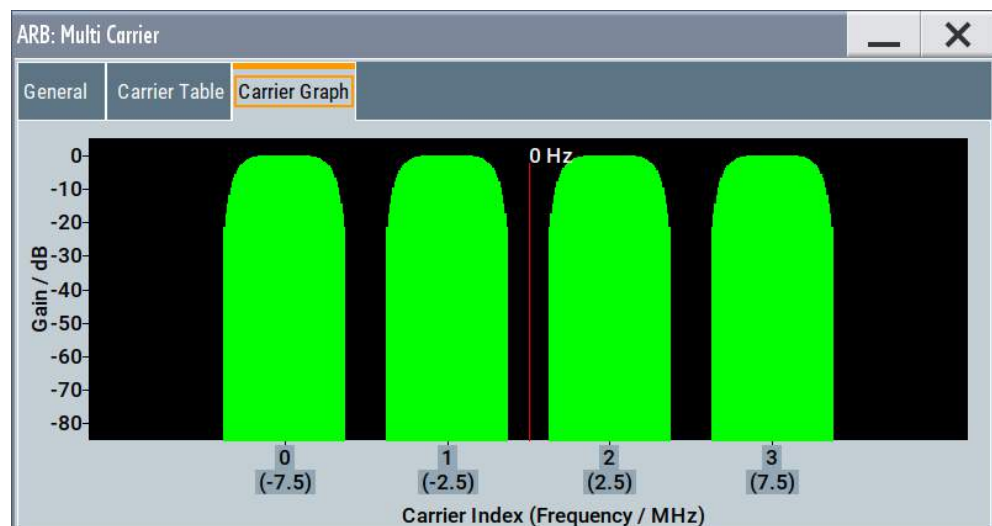

7. Select "ARB: Multi Carrier > General > Output Settings > Output File" and enter the name of the output file, for example `4x5MHz_3gpp_1_16`.
8. To trigger signal calculation and to load the waveform in the ARB generator, select "ARB: Multi Carrier > General > Create/Create and Load" function.
9. Select "ARB > General > Load Waveform".
Confirm that the generated multi-carrier waveform is used.
10. Select "ARB > State > On" to enable the ARB generator.

3.9 Generating Multi-Carrier Continuous Wave Signal

The multi-carrier continuous wave (MCCW) is a firmware option that enables the R&S SMBV100B to calculate up to 160001 continuous wave signals.

3.9.1 Required Options

The equipment layout for processing of waveform files includes

- Base unit
- Option Multi-Carrier CW (R&S SMBVB-K61)

3.9.2 About the MCCW

The R&S SMBV100B can calculate and generate a multi-carrier continuous wave signal build form up to 8192 unmodulated carriers. The carrier offset and the power level of the carriers are user-definable. The provided settings allow individual configuration of each carrier and the joint configuration of subset of carriers. Automatic start phase setting is provided to minimize the crest factor.

The multi-carrier CW signals are not generated in realtime but rather computed in arbitrary waveform mode. Changes in the carrier settings are not considered until the instrument is triggered to accept and apply them.

The common application fields of the multi-carrier CW signals are the receiver tests with broadband test signals.

3.9.3 MCCW Settings

Access:

- ▶ Select "Baseband > Multi-Carrier CW".

The dialog enables direct carrier configuration, access to the carrier table and the graphical representation of the configured carriers.

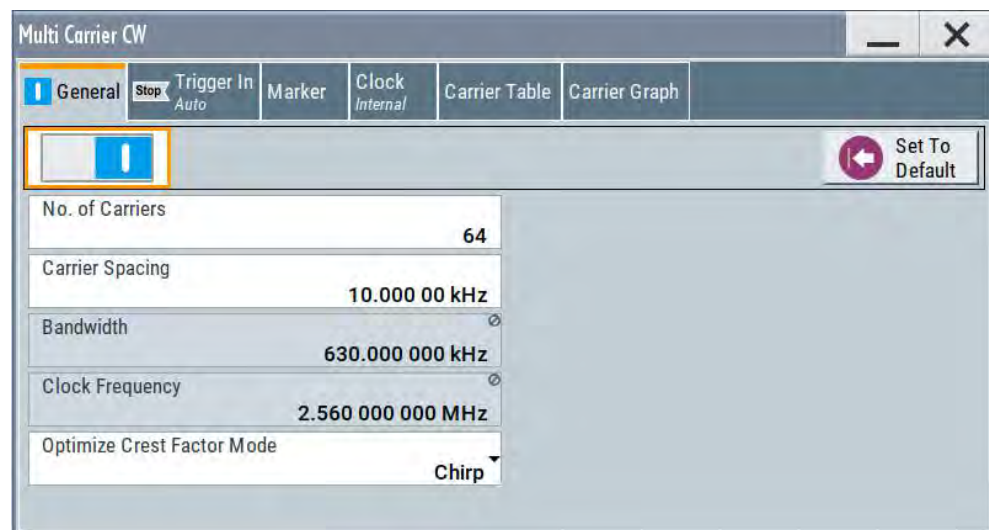

The remote commands required to define these settings are described in [Chapter 12.16.4.5, "SOURce:BB:MCCW Subsystem"](#), on page 771.

Settings:

3.9.3.1 General Carrier Settings

Access:

- ▶ Select "Baseband > Multi-Carrier CW".

Settings:

State.....	216
Set to Default.....	217
Number of Carriers.....	217
Carrier Spacing.....	217
Bandwidth.....	217
Clock Frequency.....	217
Optimize Crest Factor Mode.....	217
Desired Crest Factor.....	218

State

Enables/disables the Multi-Carrier CW.

Switching on this option, turns off all the other digital standards and digital modulation modes in the corresponding signal path.

Multi-carrier CW signals are computed in arbitrary waveform mode. To adopt the changes in the settings of individual carriers, select "Accept". This selection applies to the settings in the "Table Setup Assistant" section and the "Carrier Table" dialog.

Remote command:

[:SOURce<hw>] :BB:MCCW:STATe on page 776

Set to Default

Calls the default settings, see [Table 3-21](#).

Remote command:

[\[:SOURce<hw>\]:BB:MCCW:PRESet](#) on page 776

Number of Carriers

Sets the number of carriers composing the multi-carrier CW signal.

Note: Cross-reference between total bandwidth, carrier spacing, and number of carriers. The total bandwidth of the multi-carrier CW signal is calculated as follows:

Total Bandwidth = ("Number of Carriers" - 1) * "Carrier Spacing"

The result must not exceed the system bandwidth of the instrument (see data sheet).

If the total bandwidth is not respected, the value selected as "Carrier Spacing" is reduced. Hence, the selected number of carriers defines the maximum carrier spacing.

By default, the multi-carrier table lists 64 carriers that are preset to the settings: "State = On", "Power = 0 dB", "Phase = 0°".

If the selected number of carriers is less than the carriers in the table, the superfluous table rows are deleted. If the number of carriers exceeds the number of table rows, new rows are appended to the table.

Remote command:

[\[:SOURce<hw>\]:BB:MCCW:CARRier:COUNT](#) on page 776

Carrier Spacing

Sets the spacing between carriers for the multi-carrier CW signal. The carriers are arranged symmetrically around the HF carrier.

Remote command:

[\[:SOURce<hw>\]:BB:MCCW:CARRier:SPACing](#) on page 777

Bandwidth

Indicates the resulting occupied signal bandwidth, calculated from the selected [Number of Carriers](#) and [Carrier Spacing](#).

Clock Frequency

Displays the clock rate at which the multi-carrier CW signal is output by the arbitrary waveform generator. The output clock rate depends on the number of carriers and the selected carrier offset.

The value indicates the resolution during the marker generation.

Remote command:

[\[:SOURce<hw>\]:BB:MCCW:CLOCK?](#) on page 777

Optimize Crest Factor Mode

Selects the mode for automatically minimizing the crest factor. The carrier start phases are automatically configured according to the selected mode.

Methods of reducing the crest factor differ regarding both the optimization achievable and the time required for computation. For more information, refer to [Chapter 3.4.1.7, "Methods for Optimizing the Crest Factor"](#), on page 107.

"Off"	There are no automatic settings for minimizing the crest factor. Use the "Phase" parameter to set the start phase.
"Chirp"	Rapid crest factor optimization regardless of the number of carriers. The minimal crest factor is 3 dB. This value is obtained, if the following prerequisites are fulfilled: <ul style="list-style-type: none"> • All carriers in the multicarrier signal are switched on. • All carriers have identical power. In a configuration which differs from these prerequisites, the achievable crest factor is worse.
"Target Crest"	Optimization of the crest factor to a desired value for all carrier configurations. The optimization time depends on the number of carriers and the desired crest factor. Computation time increases only when the number of carriers exceeds 256 and the crest factor is below 4 dB. The desired value can be entered in "Desired Crest Factor". Note: Optimization can be canceled at any time, and the current value being displayed at that moment is then used.

Remote command:

[:SOURce<hw>] :BB:MCCW:CFACTOR:MODE on page 777

Desired Crest Factor

For optimization "Target Crest", defines the desired crest factor.

Remote command:

[:SOURce<hw>] :BB:MCCW:CFACTOR on page 777

3.9.3.2 Carrier Table

Access:

- ▶ Select "Baseband > Multi-Carrier CW > Carrier Table".

The provided settings enable the configuration of selectable range of carriers.

**Settings:**

Table Setup Assistant.....	219
L Carrier Start/Stop.....	219
L Carrier State.....	219
L Power Start.....	219
L Power Step.....	220
L Phase Start.....	220
L Phase Step.....	220
L Accept.....	220
Carrier Table.....	220

Table Setup Assistant

Enables joint configuration of selectable range of carriers.

Carrier Start/Stop ← Table Setup Assistant

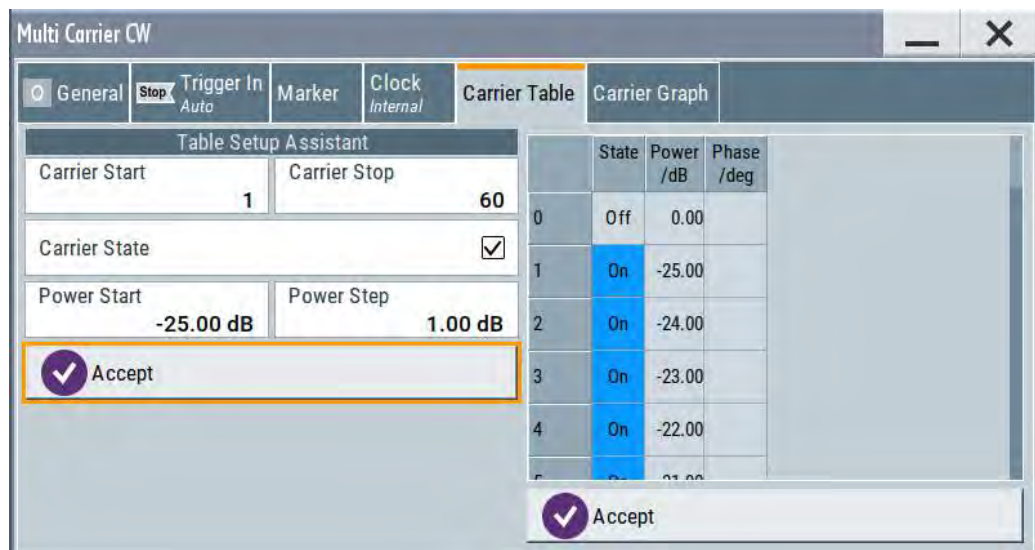
Defines the start/stop index of the carrier range to which the following settings are intended to apply.

Remote command:

`[:SOURce<hw>] :BB:MCCW:EDIT:CARRIER:START` on page 782

`[:SOURce<hw>] :BB:MCCW:EDIT:CARRIER:STOP` on page 782

Carrier State ← Table Setup Assistant

Switches the carriers in the carrier range on/off.

Remote command:

`[:SOURce<hw>] :BB:MCCW:EDIT:CARRIER:STATE` on page 782

Power Start ← Table Setup Assistant

Sets the power of the starting carrier.

Remote command:

`[:SOURce<hw>] :BB:MCCW:EDIT:CARRIER:POWER[:START]` on page 781

Power Step ← Table Setup Assistant

Sets the width of the step with which the power is changed from carrier to carrier.

The individual power of each carrier ("Carrier Table > Carrier# >Power") is calculated as "Power Start" + n*"Power Step".

Remote command:

`[:SOURce<hw>] :BB:MCCW:EDIT:CARRier:POWer:STEP` on page 781

Phase Start ← Table Setup Assistant

If "Optimize Crest Factor Mode > Off", sets the phase of the starting carrier.

Remote command:

`[:SOURce<hw>] :BB:MCCW:EDIT:CARRier:PHASe[:START]` on page 781

Phase Step ← Table Setup Assistant

If "Optimize Crest Factor Mode > Off", sets the width of the step with which the phase is changed from carrier to carrier.

The individual phase of each carrier ("Carrier Table > Carrier# >Phase") is calculated as "Phase Start" + n*"Phase Step".

Remote command:

`[:SOURce<hw>] :BB:MCCW:EDIT:CARRier:PHASe:STEP` on page 781

Accept ← Table Setup Assistant

Adopts the carrier range setting into the "Carrier Table".

Remote command:

`[:SOURce<hw>] :BB:MCCW:EDIT:CARRier:EXECute` on page 782

Carrier Table

A table with settings for the configuration of the individual carriers.

The multi-carrier CW signal is only computed when the "Accept" function is triggered. Whenever the carrier table contains settings that have not yet been adopted with the "Accept" function, the background is yellow.

Note: The phase/deg settings are only valid if optimization of the crest factor is disabled ("Optimize Crest Factor > Off").

Tip: Use the [Carrier Graph](#) function to display the current carrier configuration.

"No."	Carrier index.
"State"	Switches a carrier on/off.
"Power"	Sets the power of a carrier. If you use the Table Setup Assistant settings to fill the individual carrier powers, the power of a carrier is calculated as follows: "Power Start" + n*"Power Step".
"Phase"	Sets the starting phase of a carrier. If you use the Table Setup Assistant settings to fill the individual carrier powers, the power of a carrier is calculated as follows: "Phase Start" + n*"Phase Step".
"Accept"	Transfers the settings in the carrier table into the instrument.

Remote command:

[:SOURce<hw>] :BB:MCCW:CARRier:LIST:STATe on page 778

[:SOURce<hw>] :BB:MCCW:CARRier:STATe on page 778

[:SOURce<hw>] :BB:MCCW:CARRier:LIST:POWer on page 780

[:SOURce<hw>] :BB:MCCW:CARRier:POWer on page 780

[:SOURce<hw>] :BB:MCCW:CARRier:LIST:PHASe on page 779

[:SOURce<hw>] :BB:MCCW:CARRier:PHASe on page 779

3.9.3.3 Carrier Graph

Access:

- ▶ Select "Baseband > Multi-Carrier CW > Carrier Graph".

The "Carrier Graph" tab is a graphical representation of the current carrier configuration.

The carriers are on the X-axis and the colored bars represent those carriers which are in the active state. Power is on the Y-axis, and the height of the bars corresponds to the chosen power of each individual carrier.

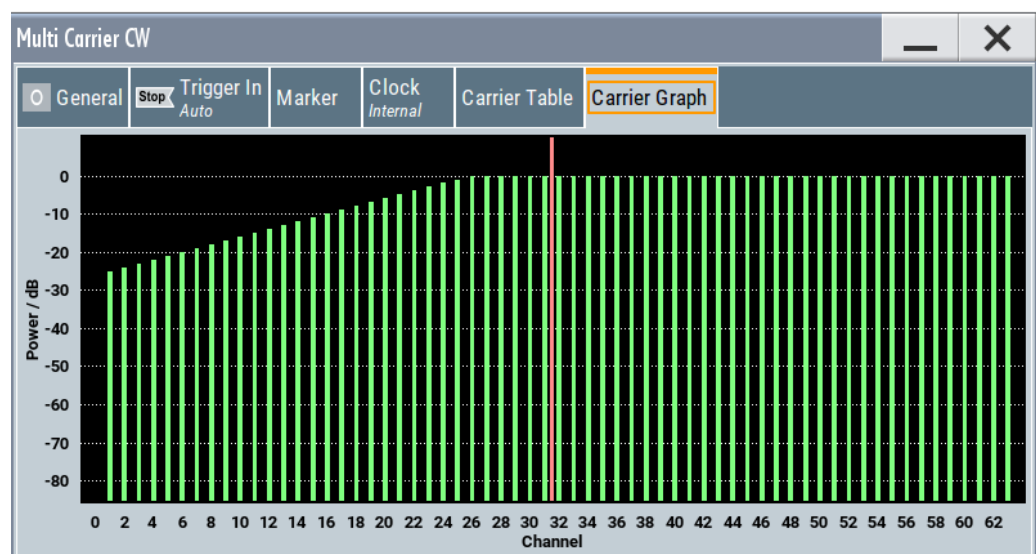

3.9.3.4 Trigger, Marker and Clock Setting

These tabs provide standard settings.

For detailed description, see:

- Chapter 3.4.2.1, "Trigger Settings", on page 110
- Chapter 3.4.2.2, "Marker Settings", on page 113
- Chapter 3.4.2.3, "Clock Settings", on page 115
- Chapter 3.4.2.4, "Global Connector Settings", on page 115

3.9.4 How to Use the Multi-Carrier Continuous Wave Function

This section provides examples on how to use the multi-carrier continuous wave function in some general test cases.

To generate a test signal for testing the frequency response of a DUT

If the test case requires a signal for DUT testing, like power amplifier or filter with a bandwidth of 80 MHz, proceed as follows:

1. Connect the DUT to the output connectors of the instrument.
2. Connect a suitable measurement equipment, like signal analyzer to the DUT.
3. Select "Baseband > Multi-Carrier Continuous Wave".
Set "No. of Carriers = 81" and "Carrier Spacing = 1 MHz".
4. Adjust further settings, e.g. trigger setting, as required.
Select "Multi-Carrier Continuous Wave > State > ON".
5. Enable the signal output: "RF > ON".
6. On the connected signal analyzer, perform the required measurement tasks. Measure the frequency response at the outputs of the DUT.

To generate a single sideband test signal for testing the image rejection

If a single sideband test signal for testing the image rejection capabilities of DUT is required, proceed as follows:

1. Connect the DUT to the output connectors of the instrument.
2. Connect a suitable measurement equipment, like signal analyzer to the DUT.
3. Select "Baseband > Multi-Carrier Continuous Wave".
Enable "No. of Carriers = 81" and "Carrier Spacing = 1 MHz".
4. Select "Multi-Carrier Continuous Wave > Carrier Table".
Set "Carrier Start = 40", "Carrier Stop = 80", "Carrier State = Off".
Confirm with "Accept".

Open the "Multi-Carrier Continuous Wave > Carrier Graph" to visualize the configured single sideband signal.

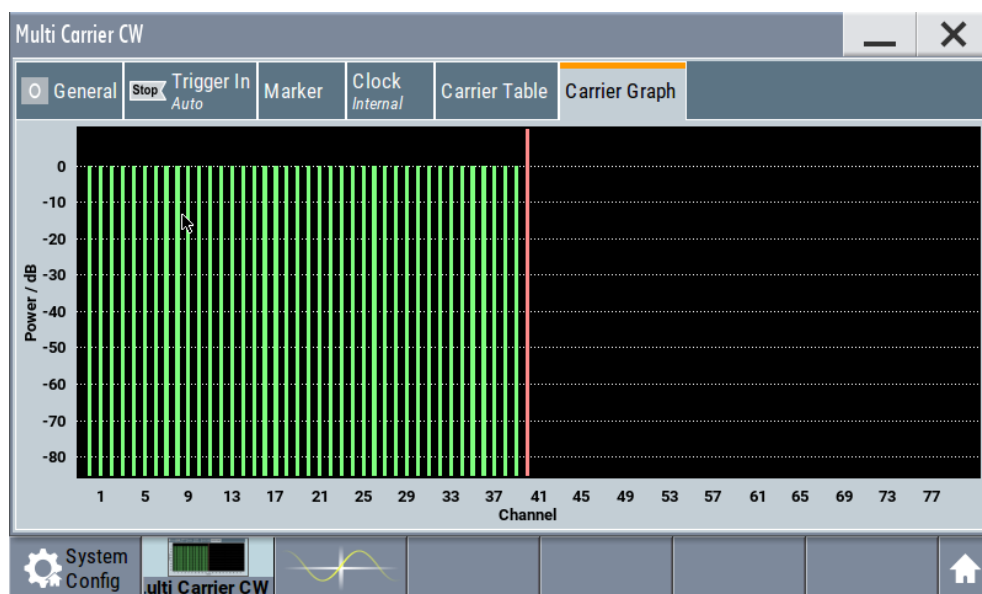

5. Adjust further settings, e.g. trigger setting, as required.
Enable signal generation with "Multi-Carrier Continuous Wave > State > ON".
6. Enable the signal output with "RF > ON".
7. On the connected signal analyzer, perform the required measurement tasks. Measure the frequency response at the outputs of the DUT.

3.9.5 References

Table 3-21: MCCW default values

Parameter	Value
State	Not affected by "Set to Default"
Carrier Setup	
Number of Carriers	64
Carrier Spacing	10 kHz
Optimize Crest Factor	Chirp
Desired Crest Factor	3 dB
Trigger	
Mode	Auto
Source	Internal
Ext. Delay	0
Ext. Inhibit	0
Marker	
Channel 1...4	Restart

Parameter	Value
Clock	
Source	Internal
Multichannel Setup	
Start Carrier	0
Stop Carrier	0
State	on
Power	0 dB
Power Step	0 dB
Initial Phase	0°
Phase Step	0°
Channel Setup	
State	ON
Phase	0°
Power	0 dB

3.10 Shifting and Boosting the Baseband Signal

The R&S SMBV100B provides settings to frequency offset the internally generated and externally supplied baseband signal.

3.10.1 About the Baseband Offsets

The applied baseband frequency and phase offset and path gain affect the signal on the output of the corresponding block, "Baseband" or "BB Input". The shifting of the central frequency of the baseband signal is one of the tasks of the resampler.

3.10.1.1 Impact of the Frequency Offset

For some applications, it is helpful to shift the baseband signal with a user defined baseband frequency offset to a different center frequency so that the signal characteristics are improved. The provided parameter frequency offset shifts the center frequency of the wanted baseband signal and provides a quick way to shift the used frequency band in the RF frequency domain without modifying the RF settings.

See [Chapter 3.10.3, "How to Improve Signal Characteristics by Shifting the Wanted Baseband Signal"](#), on page 227.

Limitations

The complex I/Q bandwidth of the shifted useful signal must not exceed the total available baseband bandwidth (see data sheet). The setting range of the frequency offset is then calculated as follows:

$$-(\text{TotalBasebandBandwidth}/2) + f_{\text{use}}/2 \leq f_{\text{offset}} \leq (\text{TotalBasebandBandwidth}/2) - f_{\text{use}}/2,$$

where

f_{use} is the complex useful bandwidth of the I/Q signal before the offset

f_{offset} is the frequency offset

The [Figure 3-19](#) illustrates the setting range of the frequency offset.

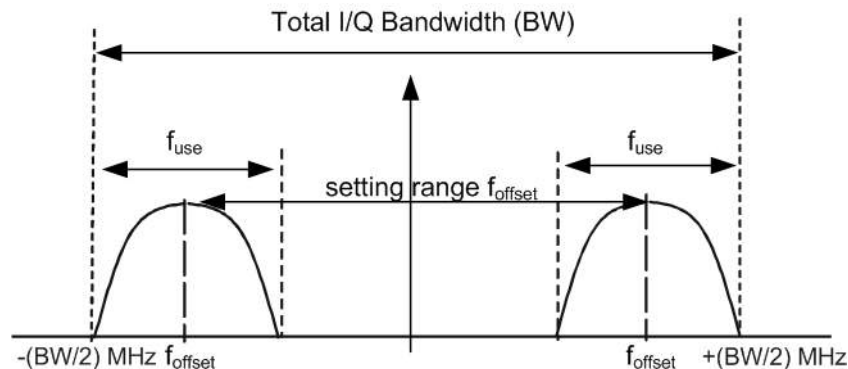

Figure 3-19: Setting range of frequency offset

Example: Calculating the maximum frequency offset

This example uses the following signal:

- "Standard = 3GPP FDD"
- "Chip Rate = 3.84 Mcps"
- "Filter Type = Root Cosine"
- "Roll Off Factor = 0.22"

The complex useful bandwidth of filtered signal is calculated as follows (see ["Impact of the Filter Parameters"](#) on page 106):

- $f_{\text{use}} = (1 + \text{"Roll Off Factor"}) * \text{"Symbol Rate"}$
- $f_{\text{use}} = (1 + 0.22) * 3.84 \text{ MHz} = 4.6848 \text{ MHz}$

For an instrument with a total available I/Q bandwidth of 160 MHz, the valid range of values for the frequency offset is then:

- $-160 \text{ MHz}/2 + 4.6848 \text{ MHz}/2 \leq f_{\text{offset}} \leq 160 \text{ MHz}/2 - 4.6848 \text{ MHz}/2$
- $-77.6576 \text{ MHz} \leq f_{\text{offset}} \leq 77.6576 \text{ MHz}$

How to observe the effect?

Use the built-in real-time graphical display ("System Configuration > Graphics > Power Spectrum") and observe the power spectrum of the signal with and without frequency offset:

- See [Chapter 2.3.5, "Verifying the Generated Signal with the Graphics Display"](#), on page 61.
- See ["To set and verify a baseband frequency offset"](#) on page 393.

3.10.1.2 Impact of the Phase Offset

The "Phase Offset" determines the phase offset between the different baseband signals. A phase offset rotates each point of an I/Q constellation diagram by the specified phase offset.

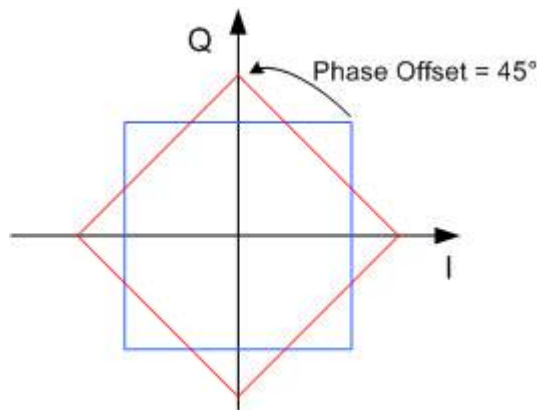

Figure 3-20: Effect of a Phase Offset of 45 degree angle on the I/Q constellation diagram

How to observe the effect?

Use the built-in real-time graphical display ("System Configuration > Graphics > Constellation") and observe that the points on the I/Q constellation diagram are turning counterclockwise.

See [Chapter 7.1, "Displaying Baseband Signal Characteristics in Real-Time"](#), on page 378.

3.10.2 Baseband Offsets Settings

Access:

- ▶ Select "Baseband > Baseband Offsets" or "BB Input > Baseband Offsets".

The "Baseband Offsets" dialog provides the settings necessary to add frequency and/or phase offset.

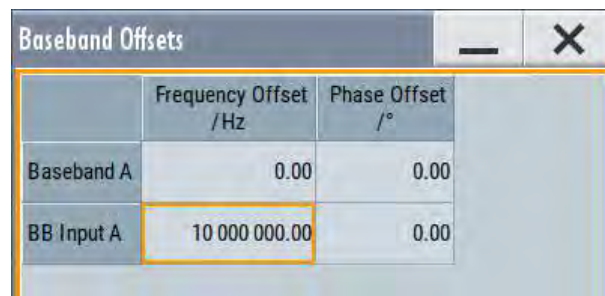

	Frequency Offset /Hz	Phase Offset /°
Baseband A	0.00	0.00
BB Input A	10 000 000.00	0.00

The block diagram shows an icon Δf on the signal path to indicate an applied frequency offset.

Settings:

Frequency Offset.....	227
Phase Offset.....	227

Frequency Offset

Enters the frequency offset for the internal or external baseband signal and shifts the useful baseband signal in the center frequency.

Use function, for example, to shift the baseband signal relative to the AWGN signal.

See:

- [Chapter 3.10.1.1, "Impact of the Frequency Offset"](#), on page 224 for detailed information on the calculation of the frequency offset value range
- [Chapter 3.10.3, "How to Improve Signal Characteristics by Shifting the Wanted Baseband Signal"](#), on page 227

Remote command:

`[:SOURce<hw>] :BB:Foffset` on page 680

`[:SOURce<hw>] :BBIN:Foffset` on page 680

Phase Offset

Enters the phase offset for the baseband signal (see [Chapter 3.10.1.2, "Impact of the Phase Offset"](#), on page 226)

The phase offset affects the signal on the "Baseband block" output.

Use this parameter, for example, to change the start phase of the baseband signal.

Remote command:

`[:SOURce<hw>] :BB:POffset` on page 681

`[:SOURce<hw>] :BBIN:POffset` on page 681

3.10.3 How to Improve Signal Characteristics by Shifting the Wanted Baseband Signal

Shifting of the generated baseband signal is useful in the following cases:

- You analyze the generated signal with a signal analyzer and the displayed signal spectrum indicates a carrier leakage (a signal drop) at the current RF frequency.

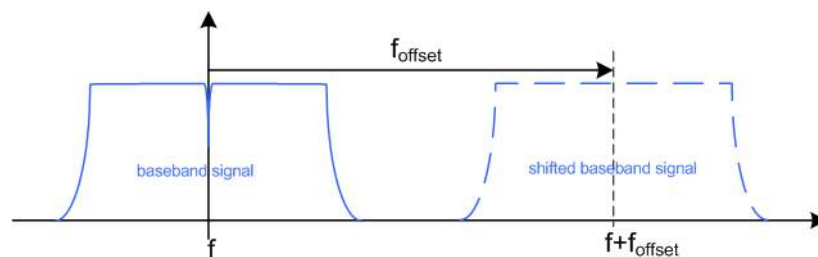

Shifting the baseband signal to a different center frequency can eliminate the carrier leakage problem.

Alternatively, apply an I and/or Q offset and vary the settings until the observed signal drop disappears, see ["To optimize the carrier leakage suppression"](#) on page 249.

In the following examples, we assume that:

- The R&S SMBV100B generates a baseband signal
- A spectrum analyzer is connected to the R&S SMBV100B, the analyzed is configured and measures the required signal characteristics.

To shift the generated baseband signal

- ▶ Select "Baseband > Baseband Offsets > Frequency Offset" and apply an offset to the generated baseband signal.

To verify the characteristics of the generated signal and to observe the effect of applied frequency offset and gain

- ▶ Use the built-in real-time graphical display.
For an example, see [Chapter 2.3.5, "Verifying the Generated Signal with the Graphics Display"](#), on page 61.

4 Adding Noise and Predistortions, and Impairing the Signal

The test case scenarios in accordance with the specifications often require a not "clean" signal but rather a signal that is impaired or interfered. To fulfill such requirements, the R&S SMBV100B is equipped with a noise generator and provides the possibility to impair and predistort the digital I/Q signal.

This section describes the following functions:

- [Adding Noise to the Signal](#).....229
- [Impairing the Signal](#).....243
- [Applying Digital Predistortion](#).....250

4.1 Adding Noise to the Signal

This section introduces the concept of the AWGN generator (Additive White Gaussian Noise). The section also describes the settings for generation of noise, sine wave interferer, and adding noise to the generated signal.

4.1.1 Required Options

The equipment layout for generating an AWGN signal includes:

- Base unit
- Option Noise Generator (R&S SMBVB-K62) per signal path

4.1.2 About the AWGN Generator

Provided the required options are installed, the R&S SMBV100B allows you to superimpose noise on the generated signal. The built-in internal noise generator generates an AWGN signal (Additive White Gaussian Noise) with selectable bandwidth and adds it to the digital baseband signal. The main characteristic of this kind of noise signal is the Gaussian distribution of the noise power density and uniform frequency distribution.

Generation of the AWGN signal

The Gaussian noise is generated with a feedback shift register with subsequent probability transformation. The switching configuration is such that ideal statistical characteristics are achieved:

- I and Q paths are decorrelated from each other.
- Small probabilities are ensured via the crest factor of ~15 dB
- The period of the noise signal is relatively long and depends on the selected system bandwidth.

- Scalable lowpass filters are used to produce a noise level with both a broad dynamic range and a broad bandwidth range.

AWGN modes

The AWGN generator generates signal in one of the following different modes:

- **"Additive Noise"**: the generated noise signal superimposes the interference-free useful signal
- **"Noise Only"**: a pure noise signal is generated and modulated to the carrier; the connection to the baseband is interrupted.

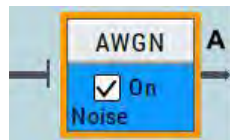

Figure 4-1: Representation of an AWGN > Mode > Noise Only in the block diagram

- **"CW Interferer"**: a sinusoidal signal with an adjustable frequency offset and carrier-to-interferer (C/I) power ratio is added to the baseband signal.

Signal and noise parameters

The [Figure 4-2](#) illustrates the relation between the signal and noise parameters.

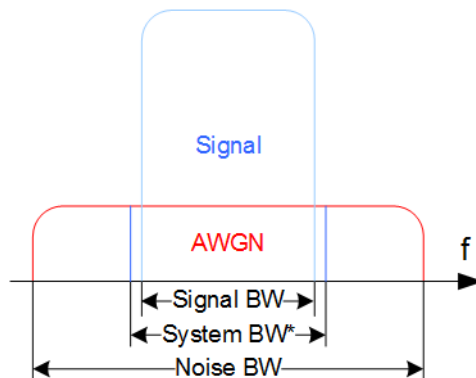

Figure 4-2: Graphical representation of the relation between system bandwidth and noise bandwidth (Minimum Noise/System BW = 2)

System BW* = Occupied BW

The **system bandwidth** is a measure for the transmitted RF bandwidth. The selected value is usually the occupied bandwidth and is therefore a value greater than the pure signal bandwidth.

In the most test cases, the signal and the noise power are not defined directly but with the target signal-to-noise ratio (SNR) or **carrier/noise ratio**.

The **carrier power** is a measure for the *signal without the noise distribution*. This indication corresponds to the "Level" value in the "Status bar" (see [Figure 4-3](#)).

To ensure flat noise within the selected system bandwidth, the **noise bandwidth** has to be larger than the system bandwidth. The minimum noise bandwidth is sometimes part of the specifications and is calculated as follows:

$$\text{"Noise Bandwidth"} = \text{"System Bandwidth"} \times \text{"Minimum Noise/System Bandwidth Ratio"}$$

Logically, the calculated noise bandwidth does not exceed the total available bandwidth of the instrument, as specified in the data sheet.

By default, the **noise power** within the system bandwidth is not defined directly but calculated depending on the selected system bandwidth and the desired SNR. The noise power over the noise bandwidth is calculated respectively.

The noise signal is not generated arbitrarily for a particular bandwidth, but instead it is generated in steps. Noise therefore also occurs outside the set system bandwidth, which means that the total measurable noise power usually exceeds the displayed value "Noise Power".

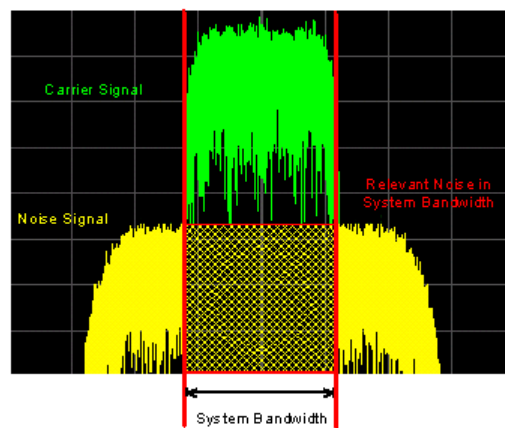

For a correct measurement of the noise power within the system bandwidth, we recommend that you perform channel power measurement with a signal analyzer.

In the "Additive Noise" mode, the output signal is the *signal with the noise distribution*. Hence, the power level at the RF output corresponds to the **carrier+noise power** (see [Figure 4-3](#)).

The noise power of digitally modulated signal is characterized by the parameter E_b/N_0 indicating the ratio of bit energy to noise power density. The correlation to the SNR is as follows:

$$C/N \text{ or } S/N = (E_b/N_0) \cdot (f_{bit}/B_{sys}), \text{ where } B_{sys} \text{ is the system bandwidth,}$$

$$\text{Bit Rate } f_{bit} = \text{"Symbol Rate"} \cdot \text{Modulation Value}$$



Where the bit rate value is retrieved from?

The parameter "AWGN > Noise Power / Output Results > Bit Rate" indicates the value used by the C/N or E_b/N_0 calculation. The value is retrieved automatically depending on the configured baseband signal:

- For signals generated by the "Custom Digital Mod", the bit rate is determined by the selected standard (see parameter "Custom Dig Mod > General" > "Symbol Rate" and "Custom Dig Mod > Modulation Type").
- For signals generated in accordance to a digital standard, the bit rate is often a standalone parameter. Some test cases however, for example the 3GPP Base Station Tests (TS 25.141), specify the E/N settings that apply to channel-coded data or block segments. Set the parameter "Bit Rate" to the required value, e.g. the bit rate before or after channel coding.

Understanding the displayed information

The following example explains the impact of the AWGN settings on the signal and noise parameters.

See [Figure 4-3](#) for an example of an AWGN generation with the following configuration:

- "Baseband"
 - "Custom Digital Modulation > Set acc. to standard > WCDMA-3GPP"
 - "State > On".
 - "Symbol Rate = 3.840 Msym/s"
- "AWGN"
 - "General > Mode > Additive Noise"
 - "General > Min Noise/System Bandwidth Ratio = 3"
 - "General > State > On"
 - "Noise Power / Output Results > Show Results for Output > RF"
 - "Noise Power / Output Results > Reference Mode > Carrier"
 - "Noise Power / Output Results > Carrier/Noise Ratio = 10 dB"
- "RF > On"



Figure 4-3: AWGN: Understanding the displayed information

- 1 = Bit Rate derived from the selected "Symbol Rate = 3.840 Msym/s"
- 2 = Selected Carrier/Noise Ratio
- 3 = Carrier Power = Status bar > Level = 30 dBm
- 4 = Noise Power calculated from the "Carrier Power" and the "Carrier/Noise Ratio" = -30 dBm - 10 dB = -40 dBm
- 5 = Carrier+Noise Power = power at the RF output; i.e. the power a connected power meter would measure
- 6 = Noise Bandwidth = System Bandwidth*Minimum Noise/System Bandwidth Ratio = 3.840 MHz*3 = 11.520 MHz



Use the built-in graphical signal monitoring function of the instrument to display the signal characteristics in real-time, see ["To observe the effect of enabled additive noise \(AWGN\)"](#) on page 396.

Application fields

Typically, the noise generator is required for the following tests:

- In receiver sensibility tests with predefined SNR of the receiver, see ["To configure the AWGN for receiver sensibility tests with predefined SNR of the receiver"](#) on page 241
- In bit-error or block-error measurements, depending on the set signal-to-noise ratio (SNR)
- Whenever a pure noise signal is required

4.1.3 AWGN Settings

The "AWGN" block provides access to the settings for the AWGN generator.

How to access and configure the "AWGN Settings"

1. Select "Block Diagram > AWGN".

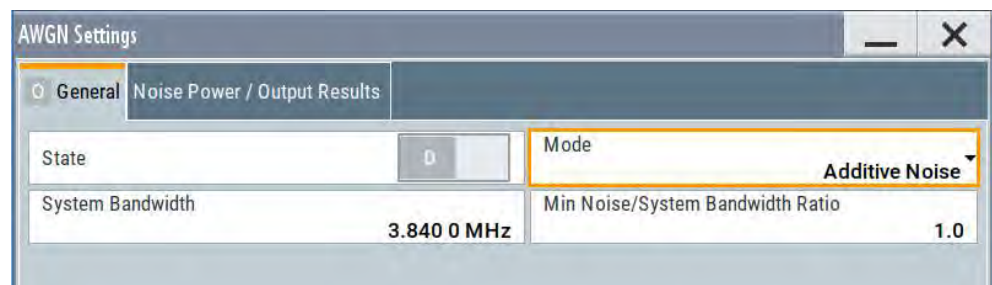

The dialog contains the settings for noise level configuration and CW interfering parameters.

- To activate the AWGN generator, select "Block Diagram > AWGN > On".

The remote commands required to define these settings are described in [Chapter 12.16.4.6, "SOURce:AWGN Subsystem"](#), on page 787.

Settings:

4.1.3.1 General Settings

Access:

- Select "Block Diagram > AWGN".

Settings:

State.....	234
Mode.....	234
System Bandwidth.....	235
Minimum Noise/System Bandwidth Ratio.....	235
Target CW Frequency Offset.....	235

State

Activates/deactivates the generation of an AWGN signal. The interferer (AWGN or CW interferer, depending on the selected mode) is generated after the generator is activated.

Remote command:

[:SOURce<hw>] :AWGN:STATe on page 789

Mode

Selects the mode for generating the interfering signal.

"Additive Noise"	The AWGN noise signal with selectable system bandwidth is added to the baseband signal.
"Noise Only"	The pure AWGN noise signal with selectable system bandwidth is modulated to the carrier. The connection to the baseband is interrupted.

"CW Interferer" A sine with a defined frequency offset is added to the baseband signal.
This mode is disabled in "System Configuration" with more than 4 input streams.

Remote command:

[:SOURce<hw>] :AWGN:MODE on page 790

System Bandwidth

For "Additive Noise" and "Noise Only" modes, sets the RF bandwidth to which the set carrier/noise ratio relates.

Within this frequency range, the signal is superimposed with a noise signal which level corresponds exactly to the set C/N or S/N ratio.

For more information, refer to the description of [Figure 4-2](#).

Remote command:

[:SOURce<hw>] :AWGN:BWIDth on page 790

Minimum Noise/System Bandwidth Ratio

For "Additive Noise" and "Noise Only" modes, sets the ratio of minimum noise bandwidth to system bandwidth, as required by some standards.

Noise Bandwidth = System BW x Minimum Noise/System BW Ratio

The parameter [Noise Bandwidth](#) displays the resulting noise bandwidth. Because the noise power density is a constant value, increasing the noise/system bandwidth ratio increases the noise bandwidth.

The calculation of level from the selected C/N or S/N ratio in relation to system bandwidth is not influenced.

Remote command:

[:SOURce<hw>] :AWGN:BWIDth:RATio on page 790

Target CW Frequency Offset

In "CW Interferer" mode, sets the desired frequency of the sine wave.

Remote command:

[:SOURce<hw>] :AWGN:FREQuency:TARGet on page 794

4.1.3.2 Noise Power/Output Results Settings

Access:

- ▶ Select "AWGN > Noise Power/Output Results".

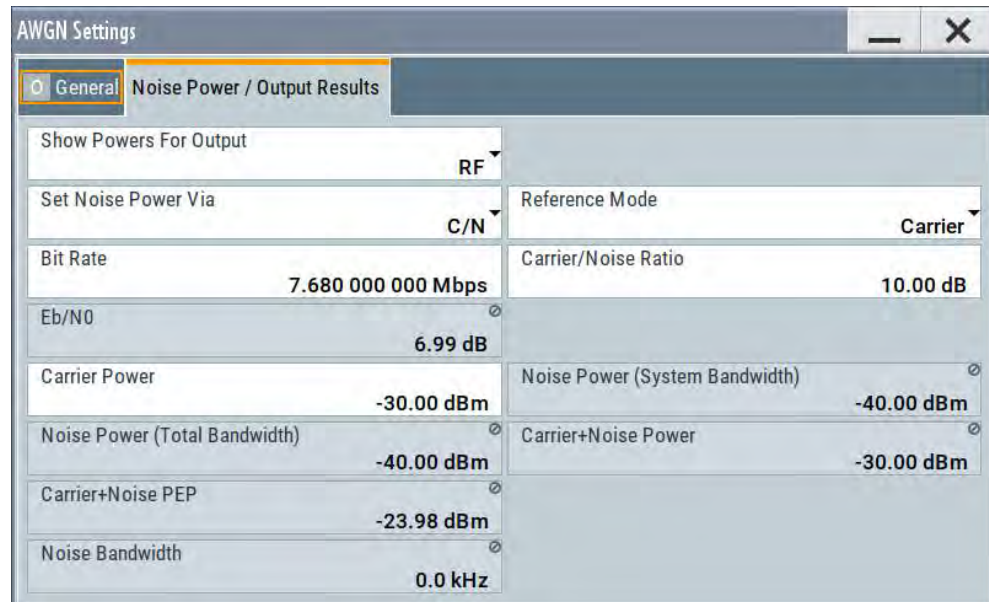

The available settings depend on the selected [Mode](#).

Settings:

Show Powers for Output.....	236
Set Noise Power Via.....	237
Reference Mode.....	237
Bit Rate.....	237
Carrier/Noise Ratio, Signal/Noise Ratio.....	237
E_b/N_0	238
Carrier Power, Signal Power.....	238
Noise Power (System Bandwidth), Interferer Power.....	239
Noise Power (Total Bandwidth).....	240
Carrier + Noise Power, Signal + Noise Power (System Bandwidth), Carrier + Interferer Power, Signal + Interferer Power	240
Carrier + Noise PEP, Signal + Noise PEP (Total Bandwidth), Carrier + Interferer PEP, Signal + Interferer PEP.....	240
Noise Bandwidth.....	240
Resulting CW Frequency Offset.....	240

Show Powers for Output

Sets the output to which the displayed settings are related to.

This setting also influences:

- The way the interfering parameters are displayed, e.g. if the SNR value is defined as C/N or as S/N.

- The value units:
 - The values related to the RF outputs are displayed in dBm
 - The values related to the baseband outputs - in dB

Remote command:

[:SOURce<hw>] :AWGN:DISP:MODE on page 791

Set Noise Power Via

In "Additive Noise" mode, selects the way the noise power is determined.

The following correlation applies:

"C/N or S/N" = $(E_b/N_0) * (f_{bit}/B_{sys})$, where:

- "C/N or S/N" is the carrier/noise ratio
- " E_b/N_0 " is the ratio of bit energy to noise power density
- "Bit Rate" f_{bit} = "Symbol Rate" x Modulation Value
- B_{sys} is the system bandwidth.

See also [Chapter 4.1.2, "About the AWGN Generator"](#), on page 229.

Remote command:

[:SOURce<hw>] :AWGN:POWer:MODE on page 791

Reference Mode

Selects whether the carrier or the noise power is kept constant if the C/N or E_b/N_0 ratio is changed.

In the common case, the instrument keeps the carrier power and adjusts the noise power accordingly. Some test cases however, for example the 3GPP Base Station Tests (TS 25.141), specify explicitly the noise power. These test cases require that the noise power is permanently set as a function of the base station power class, whereas the carrier power is variable.

Remote command:

[:SOURce<hw>] :AWGN:POWer:RMODE on page 791

Bit Rate

In "Additive Noise" mode, indicates the bit rate used for converting C/N or S/N to E_b/N_0 .

Tip: For digitally modulated signals, select the bit rate before or after channel coding, as required.

See also [Chapter 4.1.2, "About the AWGN Generator"](#), on page 229.

Remote command:

[:SOURce<hw>] :AWGN:BRATe on page 792

Carrier/Noise Ratio, Signal/Noise Ratio

In "Additive Noise" and "CW Interferer" mode, sets the carrier/noise, signal/noise or signal/interferer ratio.

Whether a configuration of C/N or S/N is enabled, depend on the selected output [Show Powers for Output](#).

- In "Reference Mode > Carrier": sets the noise power. It does not affect the power of the useful signal, i.e. the carrier power remains constant. Thus the power of the carrier + noise signal or the *power of the output signal* changes.

- In "Reference Mode > Noise", sets the *power of the useful signal*, i.e. the carrier power.
The power of the output signal remains constant.
- The power of the noise signal is derived from the entered C/N or S/N value and displayed with the parameter "Noise Power" in the units of the useful signal.
- The power of the useful signal is displayed with the parameter "Carrier Power" and can also be changed there. This indication corresponds to the "Level" value in the "Status bar".
- The power of the output signal is displayed as "Carrier + Noise Power".

See also [Figure 4-3](#).

Remote command:

`[:SOURCE<hw>] :AWGN:CNRatio` on page 792

E_b/N_0

In "Additive Noise" mode, sets the ratio of bit energy to noise power density.

- In "Reference Mode > Carrier": sets the *noise power* and hence the power of the output signal, i.e. the carrier + noise signal.
It does not affect the power of the useful signal, i.e. the carrier power is kept constant.
- In "Reference Mode > Noise": sets the *power of the useful signal*, i.e. the carrier power.
The noise power is kept constant.
- The power of the noise signal is derived from the selected E_b/N_0 and displayed with the parameter "Noise Power" in the units of the useful signal.
- The power of the useful signal is displayed with the parameter "Carrier Power".
This indication corresponds to the "Level" value in the "Status bar".
- The power of the output signal is displayed as "Carrier + Noise Power".

See also [Figure 4-3](#).

Remote command:

`[:SOURCE<hw>] :AWGN:ENRatio` on page 792

Carrier Power, Signal Power

(Additive Noise and CW Interferer)

The name of this parameter depends on the selected output [Show Powers for Output](#).

- In "Reference Mode > Carrier": sets the carrier power. This indication corresponds to the "Level" value in the "Status bar".
The power of the noise signal is derived from the selected C/N or S/N value and displayed with the parameter "Noise Power" in the units of the useful signal.
- In "Reference Mode > Noise", indicates the carrier power as derived from the entered C/N or S/N value. This indication corresponds to the "Level" value in the "Status bar".
The noise power can be set with the parameter "Noise Power".

Note: The peak envelope power (PEP) displayed in the "Status bar" corresponds to the PEP value of the carrier. The parameter "Carrier+Noise (PEP)" indicates the PEP value of the overall signal.

See also [Figure 4-3](#).

Remote command:

`[:SOURce<hw>] :AWGN:POWer:CARRier` on page 792

Noise Power (System Bandwidth), Interferer Power

Displays the power of the noise signal in the system respectively the total bandwidth in "Noise Only" and "Additive Noise" mode.

- "Noise Only" mode
 - Sets the power of the noise signal. This indication corresponds to the "Level" value in the "Status bar".
- "Additive Noise" mode
 - "Reference Mode > Noise"
 - Sets the power of the noise signal. The power of the carrier is derived from the entered C/N or S/N or Eb/N0 value.
 - "Reference Mode > Carrier"
 - Displays the power of the noise signal in the system bandwidth. The power of the noise signal is derived from the entered C/N or S/N or Eb/N0 value. The carrier power is selected with "Carrier Power"; respectively the signal power is displayed by "Signal Power".
- "CW Interferer" mode
 - "Reference Mode > Noise"
 - Sets the power of the interfering signal. The power of the carrier is derived from the entered C/I value.
 - "Reference Mode > Carrier"
 - Displays the power of the interfering signal. The power of the interfering signal is derived from the entered C/N or S/N value. The carrier power is entered under "Carrier Power".

Note: The noise signal is not generated arbitrarily for a particular bandwidth, but instead it is generated in steps. Noise therefore also occurs outside the set system bandwidth. This means that the total measurable noise power usually exceeds the value displayed here. For correct measurement of the noise power within the system bandwidth, we recommend that you measure the channel power with a signal analyzer.

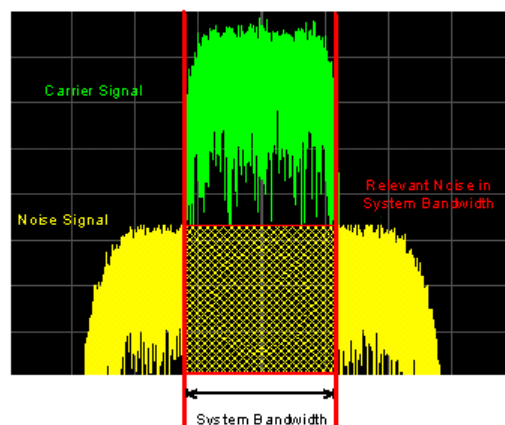

See also [Figure 4-3](#).

Remote command:

`[:SOURce<hw>] :AWGN:POWer:NOISe` on page 793

Noise Power (Total Bandwidth)

Displays the power of the noise signal in the total bandwidth in "Noise Only" and "Additive Noise" mode.

See also [Figure 4-3](#).

Remote command:

`[:SOURce<hw>] :AWGN:POWer:NOISe:TOTal?` on page 793

Carrier + Noise Power, Signal + Noise Power (System Bandwidth), Carrier + Interferer Power, Signal + Interferer Power

In "Additive Noise" and "CW Interferer" mode, displays the overall power of the noise/interferer signal plus useful signal.

The output selected with the parameter [Show Powers for Output](#) determines:

- The name of this parameter
- The units the overall power is measured in, dBm or dB (full scale)

See also [Figure 4-3](#).

Remote command:

`[:SOURce<hw>] :AWGN:POWer:SUM?` on page 793

Carrier + Noise PEP, Signal + Noise PEP (Total Bandwidth), Carrier + Interferer PEP, Signal + Interferer PEP

In "Additive Noise" and "CW Interferer" mode, displays the peak envelope power (PEP) of the overall signal comprised of noise signal plus useful signal.

The output selected with the parameter [Show Powers for Output](#) determines:

- The name of this parameter
- The units the overall power is measured in, dBm or dB (full scale)

Note: The peak envelope power ("PEP") displayed in the "Status bar" corresponds to the PEP value of the carrier.

Remote command:

`[:SOURce<hw>] :AWGN:POWer:SUM:PEP?` on page 794

Noise Bandwidth

For "Additive Noise" and "Noise Only" modes and with activated AWGN generator, indicates the real noise bandwidth.

See also [Figure 4-2](#).

Remote command:

`[:SOURce<hw>] :AWGN:BWIDth:NOISe?` on page 791

Resulting CW Frequency Offset

In "CW Interferer" mode, indicates the resulting frequency offset of the sine wave.

Remote command:

`[:SOURce<hw>] :AWGN:FREQuency:RESult?` on page 794

4.1.4 How to Configure the Noise Generator for Receiver Tests

This section shows you how to configure the noise generator for receiver tests, for example the tests specified in the 3GPP test specification TS 36.141, Chapter 7.

For the following example, we assume that the R&S SMBV100B generates an uplink EUTRA/LTE signal with following characteristics:

- "EUTRA/LTE > Duplexing = FDD", "Link Direction = Uplink"
- "EUTRA/LTE > General Uplink Setting > Channel Bandwidth = 5 MHz" and "Occupied Bandwidth = 4.5 MHz"
- "EUTRA/LTE > Frame Configuration > UE1 > FRC > FRC State = On" and "FRC = TS 36.141: A2-3"
- "EUTRA/LTE > State = On"
- "Status bar > Frequency = 1.95 GHz" and "Level = -69.9 dBm"
- "RF State > On"

To configure the AWGN for receiver sensibility tests with predefined SNR of the receiver

We assume that an AWGN interfering signal with the following characteristics is required:

The mean power of the interfering signal is -82.5 dBm/BW and C/N = 12.6 dB.

1. Select "AWGN" and enable:
 - "Mode > Additive Noise"
 - "System Bandwidth = 4.5 MHz"
The definition of the interfering signal mean power is dBm/BW, where BW is the system bandwidth. The system bandwidth of the LTE signal is the occupied bandwidth.
See also [Figure 4-2](#).
 - "Min Noise/System Bandwidth Ratio = 1.5"
2. Select "Noise Power/Output Results" and enable:
 - "Set Noise Power Via = C/N"
 - "Reference Mode = Carrier"
 - "Carrier/Noise Ratio = 12.6 dB"

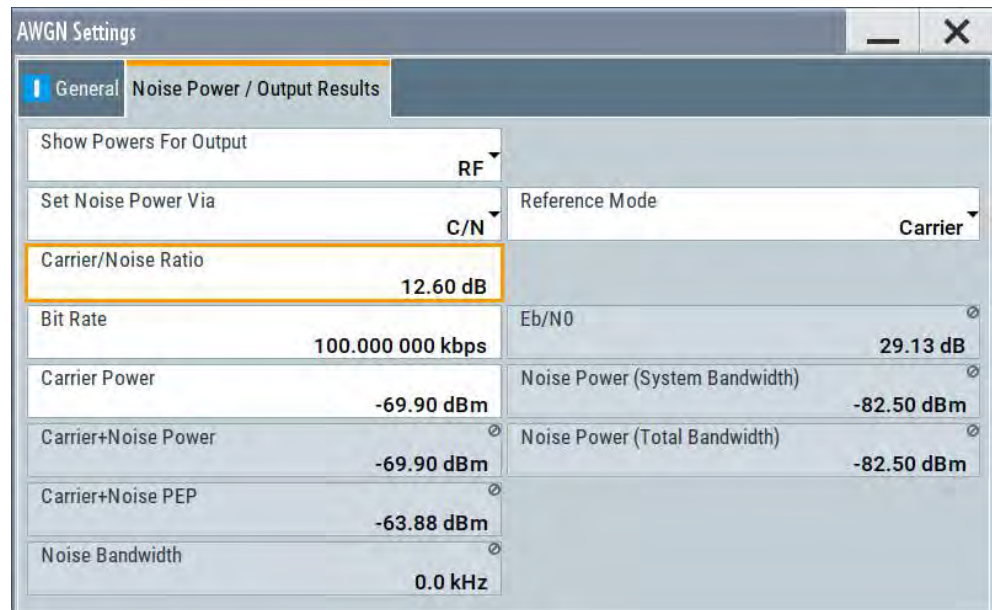

The dialog confirms the required mean power of the interfering signal "Noise Power (System Bandwidth) = -82.5 dBm".

3. Select "AWGN > General > State > On".

To generate a CW interfering signal

For the following example, we assume that two interfering signals are required, a 5 MHz uplink LTE signal and a CW signal. The signals are transmitted at -52 dBm; the LTE signal at 1.96 GHz and the CW signal 10 MHz below it. Signals with equal (or similar) RF levels and at frequencies spaced within the max. RF bandwidth can be generated by the same path.

To configure the instrument:

1. Enable the required LTE signal:
 - a) Select "EUTRA/LTE > General Uplink Setting > Channel Bandwidth = 5 MHz" and "EUTRA/LTE > State = On"
 - b) Select "Status bar > Frequency = 1.96 GHz" and "Level = -52 dBm"
2. Enable the required interfering signal:
 - a) Select "AWGN > General > Mode > CW Interferer"
 - b) Select "Target CW Frequency Offset = 10 MHz"
 - c) Select "Noise Power/Output Results > Reference Mode = Noise"
 - d) Select "Interferer Power = -52 dB"
 - e) Select "AWGN > General > State > On".
3. Select "RF > State > On"

4.2 Impairing the Signal

In the R&S SMBV100B, *analog and digital linear impairments* such as I/Q imbalance and quadrature error can be added to the generated signal.

The instrument can also simulate the effect of non-linear memoryless effects like AM/AM and AM/PM conversion.

See user manual R&S SMBVB-K540, R&S SMBVB-K541 Envelope Tracking and AM/AM, AM/PM Predistortion.

4.2.1 Required Options

The base unit is sufficient. Additional options are not required.

4.2.2 About the Linear I/Q Impairments

Signal impairments (**I/Q Impairments**) are well-defined arithmetic modifications of the data. Every data sample is modified in the same way.

Adding linear impairments to the data stream is provided for the following purpose:

- To simulate frequent sources of distortions in a real signal-processing chain as, it is required for tests with dirty transmitter conditions (receiver tests)
- To compensate the faults of the I/Q demodulator in the receiver

See [Chapter 4.2.4, "How to Optimize the Carrier Leakage and Sidebands Suppression"](#), on page 249.

The R&S SMBV100B offers functions to impair the internally generated signal or the externally fed analog I/Q signal linearly:

- Each generated I/Q stream can be impaired digitally
- Analog impairments can be added to the externally applied analog I/Q signal, before it is passed to in the I/Q modulator (see ["Defining the input signal of the I/Q modulator"](#) on page 251)
- The internal signal can be impaired twice, analog and digital. If both types of impairments are enabled, they superimpose each other in the signal.

Impairments caused by the I/Q modulator are automatically corrected by the [Adjust I/Q Modulator Current Frequency](#) function.

See also ["Internal Adjustments"](#) on page 921.

4.2.2.1 Gain and Gain Imbalance

An I/Q gain is a multiplication of all I/Q amplitudes by a common factor. The effect is equivalent to two identical I and Q gain factors. The effect of an increased gain factor in the I/Q constellation diagram is shown on [Figure 4-4](#).

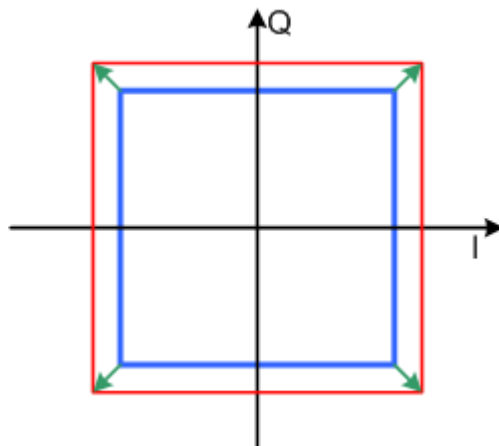

Figure 4-4: Effect of an increased amplitude in the I/Q constellation diagram

An I gain multiplies the I amplitudes by a factor, leaving the Q amplitudes unchanged. A Q gain has the opposite effect. Different I and Q gain factors result in an I/Q imbalance, which is due to different gains of the amplifiers in the I and Q channels of the I/Q modulator. The effect of a positive and negative gain imbalance is shown on [Figure 4-5](#).

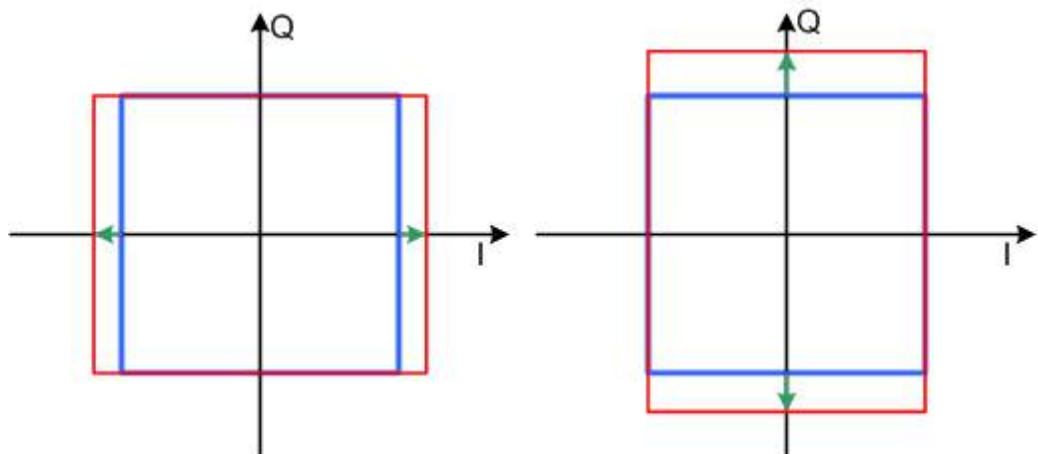

Figure 4-5: Negative gain imbalance (left) and positive gain imbalance (right) in the I/Q constellation diagram

4.2.2.2 I and Q Offset

An I offset adds a constant value to all I amplitudes, leaving the Q amplitudes unchanged. A Q offset has the opposite effect. A combination of I and Q values results in an I/Q offset, which is due to carrier feedthrough in the I/Q modulator. Possible reasons are interfering signals at the RF carrier frequency, e.g. an unsuppressed RF carrier subchannel. The effect of a positive I and Q offset in the I/Q constellation diagram is shown on [Figure 4-6](#).

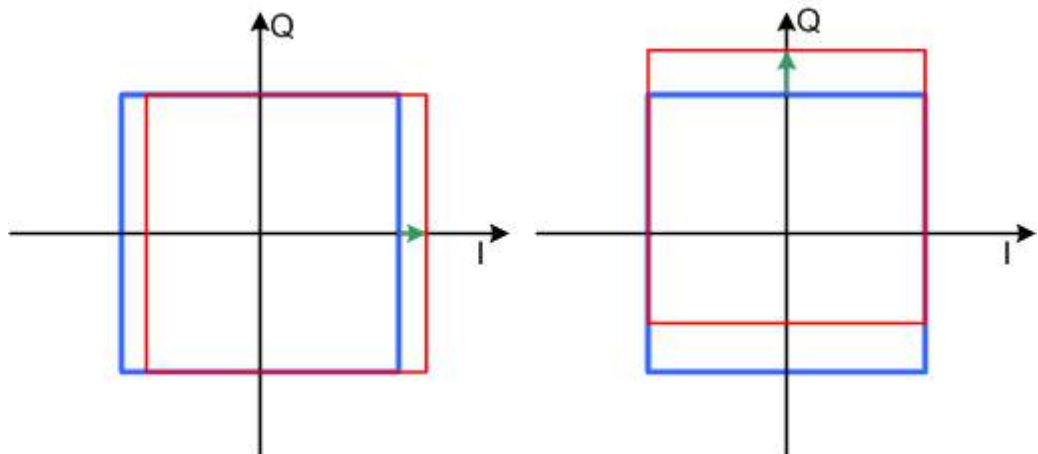

Figure 4-6: I offset (left) and Q offset (right) in the I/Q constellation diagram

4.2.2.3 Quadrature Offset

Changes the phase angle between the I and the Q vectors from the ideal 90 degrees, while the amplitudes are maintained. A positive quadrature offset results in a phase angle greater than 90 degrees. The effect of a positive quadrature offset in the I/Q constellation diagram is shown on Figure 4-7.

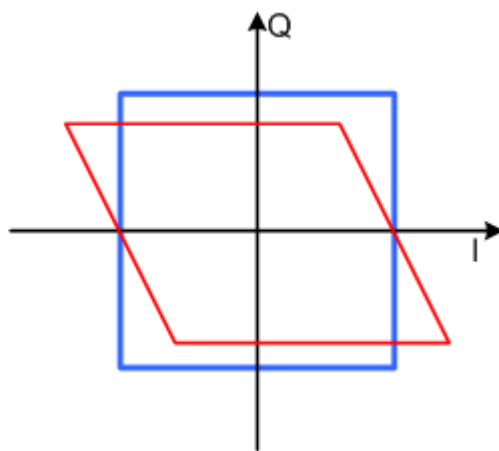

Figure 4-7: Positive quadrature offset in the I/Q constellation diagram

4.2.3 Analog and Digital Impairments Settings

You can add digital impairments to each internal generated I/Q stream and analog impairments to internal generated or external supplied analog I/Q signals

See also [Chapter 4.2.2, "About the Linear I/Q Impairments"](#), on page 243.

1. To access the dialog with settings for the **analog** I/Q signal, select "I/Q Mod > Analog Impairments".

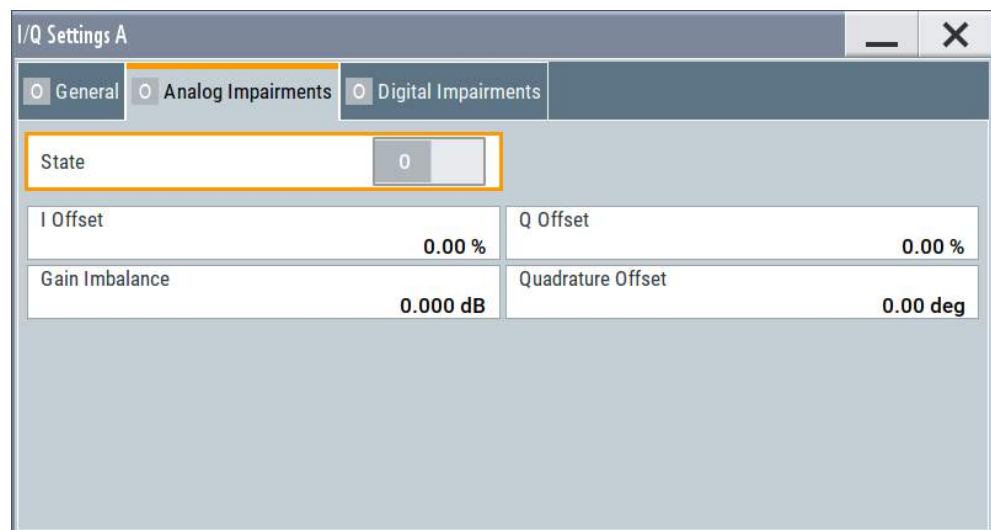

The dialog covers the settings for I/Q impairment, like carrier leakage, imbalance and quadrature offset.

- To access the dialog with settings for the corresponding **digital** I/Q impairments, select one of the following:
 - Select "I/Q Mod > Digital Impairments"
 - Select "I/Q Analog > Digital Impairments"
 - Select "I/Q Digital > Digital Impairments"

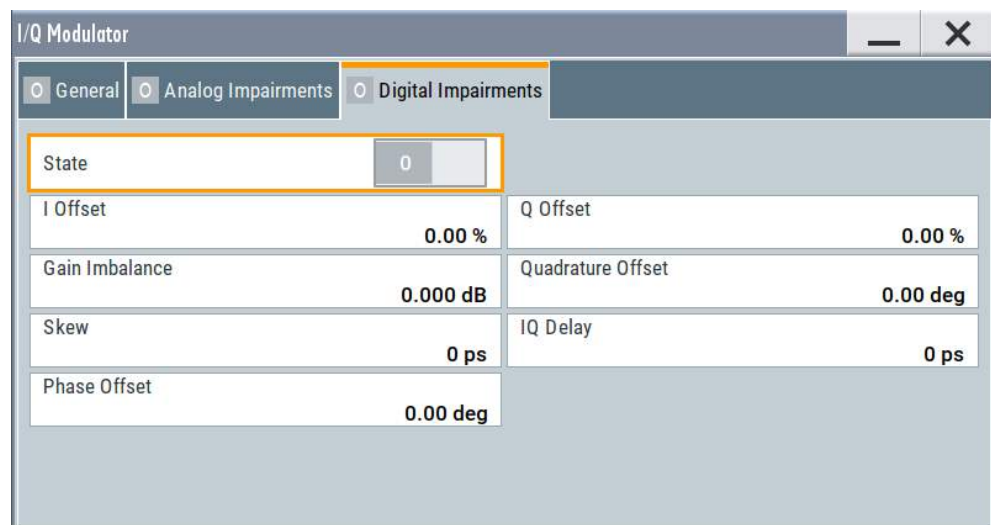

The dialog covers the settings for I/Q impairment, like carrier leakage, imbalance, offset and delay.

The parameters "Skew" and "IQ Delay" are enabled in the "I/Q Modulator or I/Q Analog > Digital Impairments" dialog.

The remote commands required to define these settings are described in:

- [Chapter 12.16.4.7, "SOURCE:BB:IMPAIrnent Subsystem"](#), on page 794.
- [Chapter 12.16.8, "SOURCE:IQ Subsystem"](#), on page 822.

The instrument can also simulate the effect of non-linear effects like AM/AM and AM/PM conversion.

See user manual R&S®SMBVB-K540, R&S®SMBVB-K541 Envelope Tracking and AM/AM, AM/PM Predistortion.

Settings:

State.....	247
I/Q Offset.....	247
Gain Imbalance.....	247
Quadrature Offset.....	248
Skew.....	248
IQ Delay.....	248
Phase Offset.....	248

State

Activates the impairment of the I/Q signal.

If activated, the settings for I/Q offset, I/Q imbalance, and quadrature offset become effective.

Remote command:

For analog impairments: `[:SOURce<hw>] :IQ:IMPairment [:STATe]` on page 798

For digital impairments:

`[:SOURce] :BB:IMPairment:RF<ch>:STATe` on page 798

`[:SOURce] :BB:IMPairment:IQOutput<ch>:STATe` on page 798

I/Q Offset

Sets a carrier offset (in percent) of the amplitudes (scaled to the peak envelope power (PEP)) for the I and/or Q signal component. An ideal I/Q modulator suppresses the carrier offset completely (offset = 0 percent).

For more information, see:

- [Chapter 4.2.2.2, "I and Q Offset"](#), on page 244
- ["To optimize the carrier leakage suppression"](#) on page 249

Remote command:

For analog impairments:

`[:SOURce<hw>] :IQ:IMPairment:LEAKage:I` on page 796

`[:SOURce<hw>] :IQ:IMPairment:LEAKage:Q` on page 796

For digital impairments:

`[:SOURce] :BB:IMPairment:IQOutput<ch>:LEAKage:I` on page 796

`[:SOURce] :BB:IMPairment:IQOutput<ch>:LEAKage:Q` on page 796

`[:SOURce] :BB:IMPairment:RF<ch>:LEAKage:I` on page 796

`[:SOURce] :BB:IMPairment:RF<ch>:LEAKage:Q` on page 796

Gain Imbalance

Sets the imbalance of the I and Q vector.

The entry is made in dB (default) or %, where 1 dB offset is roughly 12% according to the following:

$$\text{Imbalance [dB]} = 20 \log (| \text{GainQ} | / | \text{GainI} |)$$

Positive values mean that the Q vector is amplified more than the I vector by the corresponding percentage. Negative values have the opposite effect.

For more information, see:

- [Chapter 4.2.2.1, "Gain and Gain Imbalance"](#), on page 243
- ["To optimize sideband suppression"](#) on page 249

Remote command:

For analog impairments: `[:SOURce<hw>] :IQ:IMPairment:IQRatio[:MAGNitude]` on page 796

For digital impairments:

`[:SOURce] :BB:IMPairment:IQOutput<ch>:IQRatio[:MAGNitude]` on page 796

`[:SOURce] :BB:IMPairment:RF<ch>:IQRatio[:MAGNitude]` on page 796

Quadrature Offset

Sets the quadrature offset.

For more information, see:

- [Chapter 4.2.2.3, "Quadrature Offset"](#), on page 245
- ["To optimize sideband suppression"](#) on page 249

Remote command:

For analog impairments: `[:SOURce<hw>] :IQ:IMPairment:QUADrature[:ANGLE]` on page 797

For digital impairments:

`[:SOURce] :BB:IMPairment:IQOutput<ch>:QUADrature[:ANGLE]` on page 797

`[:SOURce] :BB:IMPairment:RF<ch>:QUADrature[:ANGLE]` on page 797

Skew

In the "I/Q Modulator or I/Q Analog > Digital Impairments" dialog, sets a delay between the Q vector and the I vector of the corresponding stream.

Remote command:

`[:SOURce] :BB:IMPairment:IQOutput<ch>:SKEW` on page 797

`[:SOURce] :BB:IMPairment:RF<ch>:SKEW` on page 797

IQ Delay

In the "I/Q Modulator or I/Q Analog > Digital Impairments" dialog, sets the time delay of both I and Q vectors relative to the selected trigger and marker.

A positive value means that the I and Q vectors delay relative to the marker/trigger and the other way around.

See also [Chapter 8.3.1, "Connecting Multiple Instruments in Master-Slave Mode"](#), on page 399.

Remote command:

`[:SOURce] :BB:IMPairment:IQOutput<ch>:DELay` on page 795

`[:SOURce] :BB:IMPairment:RF<ch>:DELay` on page 795

Phase Offset

Adds an additional phase offset after the stream mapper.

You can shift the phase at the different stages in the signal generation flow, see:

- "Phase Offset" on page 227
- "Phase Offset" on page 414

Remote command:

`[:SOURce] :BB:IMPairment:IQOutput<ch>:POFFset` on page 798

`[:SOURce] :BB:IMPairment:RF<ch>:POFFset` on page 798

4.2.4 How to Optimize the Carrier Leakage and Sidebands Suppression

Applying linear I/Q impairments helps to improve signal quality in the following cases:

- To suppress a carrier leakage at the current RF frequency
- To improve the attenuation of the unwanted sidebands

In the following examples, we assume that:

- The R&S SMBV100B generates a baseband signal
- A spectrum analyzer is connected to the R&S SMBV100B, the analyzed is configured, and measures the required signal characteristics.

To optimize sideband suppression

For a given baseband signal, perform the following iterative steps:

1. In the block diagram, select "I/Q Mod > I/Q Digital Impairments".
2. Set the values of the parameters "Gain Imbalance" and "Quadrature Offset" to adjust the relative amplitude and phase relationship of the baseband signal.
3. Select "State > On".
4. On a connected signal analyzer, monitor the power spectrum.
5. Vary the values of the parameters "Gain Imbalance" and "Quadrature Offset" until the maximal sideband suppression is achieved.

To optimize the carrier leakage suppression

For a given baseband signal, perform the following iterative steps:

1. In the block diagram, select "I/Q Mod > I/Q Digital Impairments".
2. Set the parameters "I Offset" and/or "Q Offset".
3. Select "State > On".
4. On a connected signal analyzer, monitor the power spectrum.
5. Vary the "I/Q Offset" until the maximal carrier leakage suppression is achieved.

Adjusting the I and Q offsets is one of the possible ways to control carrier leakage. See [Chapter 3.10.3, "How to Improve Signal Characteristics by Shifting the Wanted Baseband Signal"](#), on page 227 for other related settings.

4.3 Applying Digital Predistortion

Digital predistortion (DPD) is one of the methods, used to improve the efficiency of RF power amplifiers. In the R&S SMBV100B, the generated digital signal can be deliberately AM/AM and AM/PM predistorted.

See user manual R&S SMBVB-K540, R&S SMBVB-K541 Envelope Tracking and AM/AM, AM/PM Predistortion.

5 Applying I/Q Vector Modulation

The R&S SMBV100B offers I/Q modulation with an external analog I/Q signals, external digital signals, and the internally generated digital signal.

For a description on the signal impairment functionality and settings for applying non-linear effects, see:

- [Chapter 4.2, "Impairing the Signal"](#), on page 243

See user manual R&S SMBVB-K540, R&S SMBVB-K541 Envelope Tracking and AM/AM, AM/PM Predistortion.

5.1 Required Options

The equipment layout for I/Q modulation includes:

- Base unit
- One of the Frequency options (R&S SMBVB-B103/-KB106)
Sufficient for I/Q modulation with internal and external analog signal

5.2 About the I/Q Modulator

The R&S SMBV100B offers I/Q modulation with the internally generated digital signal, the external digital signals (when separately processed), and an external analog I/Q signal. The maximum available RF bandwidth of externally applied wideband analog signal is higher than the bandwidths of the internal or external digital signal. For exact values, refer to the instrument specification (data sheet).

Analog I/Q input signals are directly applied to the analog I/Q modulation circuit, and are not routed through the baseband section of the R&S SMBV100B.

Defining the input signal of the I/Q modulator

The [Table 5-1](#) gives an overview of the possible input signals and the connectors they are supplied at. Any of the specified input signals is processed by the I/Q modulator and output at the RF output.

Table 5-1: Physical input signals of the I/Q modulator

Input signal	Input connector	GUI parameter
Internal digital baseband signal	-	"I/Q Mod. > I/Q Mod. In > Internal Baseband I/Q In" and "Baseband > On"
External analog wideband	I/Q	"I/Q Mod. > I/Q Settings > Analog Wideband I/Q Input"
External digital signal	Dig I/Q	"I/Q Mod. > I/Q Mod. In > Internal Baseband I/Q In" and "BB Input > On"



Interdependencies

An I/Q modulation with an **external analog** signal cannot be used simultaneously with the following:

- AM, digital modulation, digital standards
- AWGN
- External digital baseband input signal, arbitrary waveform generation, and multi-carrier CW.

5.3 I/Q Modulator Settings

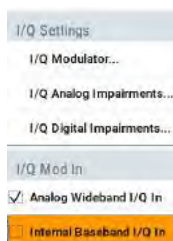

Access:

1. To configure the input signal source of the I/Q modulator, select "I/Q Mod > I/Q Mod In" and enable an internal baseband or an analog wideband input signal.
2. To access the dialog box for configuring the I/Q modulator settings, select "I/Q Mod > I/Q Settings > I/Q Modulator".

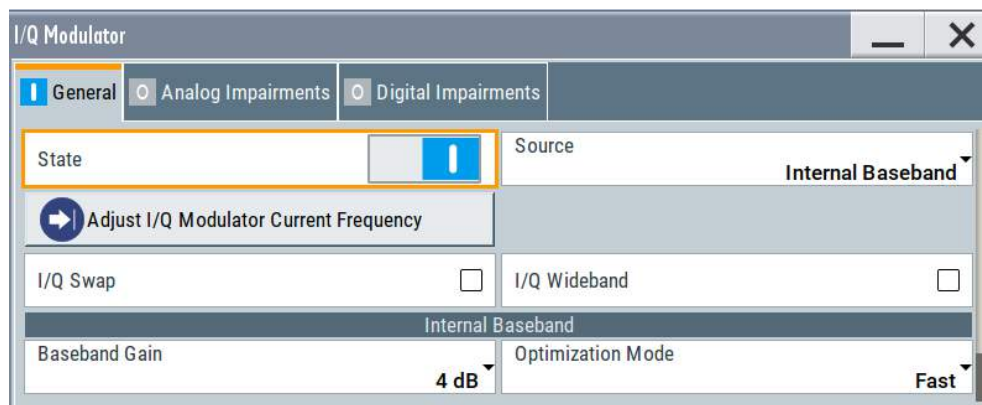

The dialog comprises the I/Q modulator settings, the optimized settings for wideband modulation and settings for enabling the analog and/or digital impairments. The remote commands required to define these settings are described in [Chapter 12.16.8, "SOURCE:IQ Subsystem"](#), on page 822.

For a description on the signal impairment functionality and settings for applying non-linear effects, see:

- [Chapter 4.2, "Impairing the Signal"](#), on page 243

See user manual R&S SMBVB-K540, R&S SMBVB-K541 Envelope Tracking and AM/AM, AM/PM Predistortion.



System error correction of the I/Q modulator permits precise and repeatable measurements.

If a temperature fluctuation of several degrees occurs, trigger the correction routine using the following:

- Select "I/Q Mod > I/Q Modulator > Adjust I/Q Modulator Current Frequency"

Settings:

State.....	253
Source.....	253
Adjust I/Q Modulator Current Frequency.....	253
I/Q Swap.....	254
I/Q Wideband.....	254
Crest Factor.....	255
Optimization Mode.....	255
(Baseband) Gain.....	255

State

Activates/deactivates I/Q modulation.

Note: Interdependency. If "Source > Internal Baseband", the I/Q modulator is always activated automatically when signal generation is activated ("Baseband > State > On"). I/Q modulation can, however, be deactivated later, e.g. if the relevant signal is the baseband signal and it is directly routed to the I/Q outputs.

Remote command:

[:SOURce<hw>] : IQ:STATe on page 823

Source

Selects the input signal for the I/Q modulator. Refer to [Table 5-1](#) for an overview of the possible input signals and the connectors they are supplied at.

"Internal Baseband"

Selects the internal baseband signal.

"Analog Wideband I/Q Input"

Selects an external analog signal.

Remote command:

[:SOURce<hw>] : IQ:SOURce on page 822

Adjust I/Q Modulator Current Frequency

Starts the adjustment for the I/Q modulator for the currently set frequency and baseband gain. The I/Q modulator is adjusted regarding carrier leakage, I/Q imbalance and quadrature.

See also "[To trigger the internal correction routine of the I/Q modulator](#)" on page 259.

Remote command:

:CALibration<hw>:IQModulator:LOCAl? on page 602



I/Q Swap

Selects normal or swapped I/Q control for the generated signal.

The I/Q modulator defined in the IS2000 standard differs from the definition in this implementation. The definition on which the implementation is based is used by virtually all digital communication standards, except IS95 and IS2000.

In the final step, the filtered IQ signal is modulated to the desired RF in a different way in the I/Q modulator:

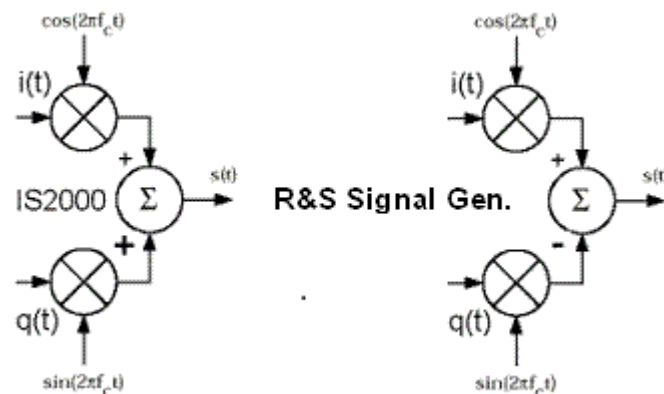

Figure 5-1: Definition of I/Q modulator in IS2000 and the R&S SMBV100B

IS2000 = the RF signal $s(t)$ is derived from the baseband I/Q signal as $s(t) = i(t)\cos(2\pi f_c t) + q(t)\sin(2\pi f_c t)$

R&S SMBVB = the RF signal $s(t)$ is based on the definition $s(t) = i(t)\cos(2\pi f_c t) - q(t)\sin(2\pi f_c t)$

See also:

- Description "CDMA2000® incl. EV-DV Digital Standard for R&S SMBV100B"
- Description "1xEV-DO Rev. A, Rev. B Digital Standard for R&S SMBV100B"

"Off" I/Q control is normal.

"On" The modulation sidebands are inverted by swapping the I and Q signals (the Q-part of the signal is inverted).
The generated baseband signal is according to CDMA200 and 1xEV-DO standards.
An I/Q modulator defined according to these standards can cope with the RF signal generated by the R&S SMBV100B.

Remote command:

`[:SOURce<hw>] : IQ : SWAP [: STATE]` on page 824

I/Q Wideband

Activates/deactivates optimization for wideband modulation signals (higher I/Q modulation bandwidth).

The modulation frequency response of the R&S SMBV100B in the useful bandwidth is improved at the expense of poorer harmonic suppression. This improvement is achieved by shifting the switching frequencies of the lowpass filters in the output section.

Remote command:

`[:SOURce<hw>] : IQ : WBState` on page 824

Crest Factor

If "Source = Analog Wideband I/Q Input", sets the crest factor of the *externally supplied analog signal*.

The crest factor gives the difference in level between the peak envelope power (PEP) and the average power value (RMS) in dB. The R&S SMBV100B uses this value for the calculation of the RF output power. For more information, refer to "[Important Signal Parameters and Interface's Characteristics](#)" on page 409

Note:

To set the crest factor of an *externally supplied digital signal*, use the parameter:

- "BB Input > Input Level" > [Crest Factor](#).

Remote command:

`[:SOURce<hw>] :IQ:CREStfactor` on page 823

Optimization Mode

Selects the optimization mode.

For information on the I/Q modulation performance in any of the modes, see the data sheet.

"Fast"	Fast optimization by compensation for I/Q skew. This mode suitable in time sensitive environments.
"High Quality"	With "Source > Internal Baseband", enables an optimization by compensation for I/Q skew and frequency response correction. This mode generates flat signal but requires longer setting time and leads to signal interruption.

Note:

Do not use the mode "I/Q Modulator > Optimization Mode > High Quality" in combination with the modes "RF Level > Setting Characteristics > Uninterrupted Level Settings/Strictly Monotone".

The high quality I/Q optimization leads to RF signal interruption. The requirements of the RF level modes "Uninterrupted Level Settings" and "Strictly Monotone" can not be fulfilled.

Remote command:

`[:SOURce<hw>] :BB:IMPairment:OPTimization:MODE` on page 798

(Baseband) Gain

Optimizes the modulation of the I/Q modulator for a subset of measurement requirement. Provided is a dynamic range of 16 dB divided into 2 dB steps. The optimization is a trade-off between signal distortion and signal-to-noise ratio (SNR).

See also [Chapter 5.5, "How to Adjust the I/Q Modulator to Optimize Performance"](#), on page 258.

"-4 dB/- 2 dB (Low Distortion)"	Activates -4 dB or -2 dB gain. Baseband signal is internally attenuated to minimize signal distortions; the intermodulation characteristics of signal are optimized, the SNR however decreases.
"0 dB"	No changes on the baseband signal; optimization is not applied.

"+2 dB/ +4 dB/ +6 dB/ +8 dB (Low Noise)"

Activates a 2 dB, 4 dB, 6 dB or 8 dB gain

Baseband signal is internally boosted to maximize the SNR; signal noise is minimized, the signal distortions however increase.

These values are suitable for 3GPP signals with high adjacent channel power ratio (ACPR).

Remote command:

For analog I/Q signal:

[:SOURce<hw>] :IQ:GAIN on page 823

For digital I/Q signal:

[:SOURce<hw>] :BB:IQGain on page 823

5.4 Frequency Response Settings

Access:

- In the block diagram, select "I/Q Mod > Frequency Response".

The dialog opens and shows the frequency response correction-related settings. The remote commands required to define these settings are described in [Chapter 12.16.5.3, "Frequency Response Commands"](#), on page 810.

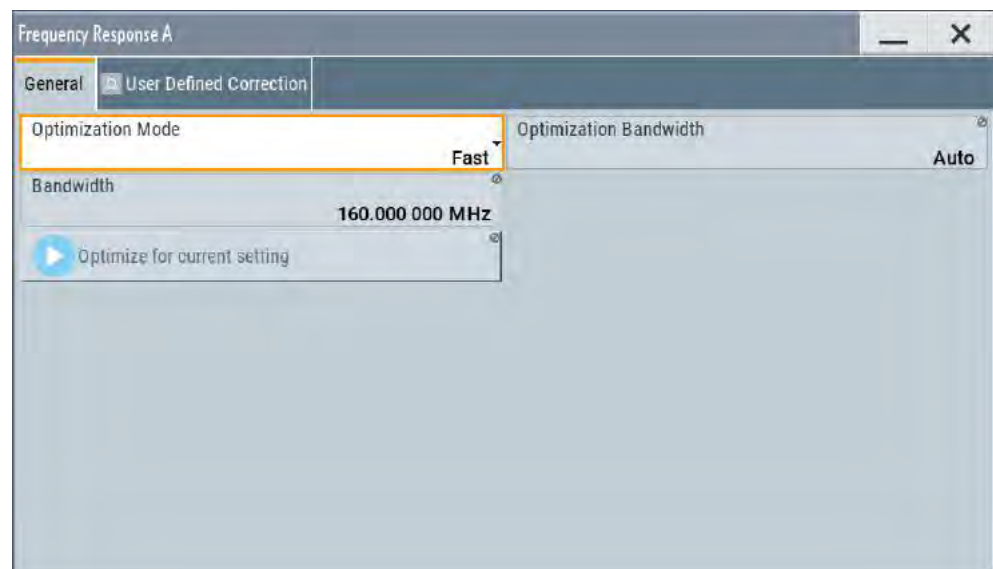

Settings:

Optimization Mode.....	257
Optimization Bandwidth.....	257
Bandwidth.....	257
Optimize for current setting.....	257

Optimization Mode

Selects the optimization mode.

For information on the I/Q modulation performance in any of the modes, see the data sheet.

"Fast"	Fast optimization by compensation for I/Q skew. This mode suitable in time sensitive environments.
"High Quality"	With "Source > Internal Baseband", enables an optimization by compensation for I/Q skew and frequency response correction. This mode generates flat signal but requires longer setting time and leads to signal interruption.

Note:

Do not use the mode "I/Q Modulator > Optimization Mode > High Quality" in combination with the modes "RF Level > Setting Characteristics > Uninterrupted Level Settings/Strictly Monotone".

The high quality I/Q optimization leads to RF signal interruption. The requirements of the RF level modes "Uninterrupted Level Settings" and "Strictly Monotone" can not be fulfilled.

Remote command:

`[:SOURce<hw>] :BB:IMPairment:OPTimization:MODE` on page 798

Optimization Bandwidth

For "Optimization Mode > High Quality/High Quality Table", defines how the signal bandwidth on that frequency response is compensated is selected.

"Auto"	Signal bandwidth is determined automatically, it corresponds to the bandwidth of the baseband signal.
"Manual"	Signal bandwidth is set with the parameter Bandwidth .

Remote command:

`[:SOURce<hw>] :CORRection:FRESponse:RF:OPTimization:BANDwidth:MODE` on page 811

Bandwidth

In "Optimization Bandwidth > Manual", sets the signal bandwidth on that frequency response is compensated.

Remote command:

`[:SOURce<hw>] :CORRection:FRESponse:RF:OPTimization:BANDwidth[:VALue]` on page 811

Optimize for current setting

Adjusts the frequency response in "High Quality" mode optimally for the selected RF frequency and level settings.

See "[Optimization Mode](#)" on page 255.

This functionality applies to the optimization mode "High Quality", i.e.

Remote command:

`[:SOURce<hw>] :CORRection:FRESponse:RF:OPTimization:LOCAL` on page 812

5.5 How to Adjust the I/Q Modulator to Optimize Performance

With its default settings, the I/Q Modulator provides vector modulated signal that is optimized for time sensitive measurements and lower noise.

Adjusting the settings helps to improve signal quality in the following cases:

- To optimize the intermodulation characteristics of the signal
- To optimize the signal-to-noise ratio (SNR) of the signal
- To improve the flatness of the RF signal

In the following examples, we assume that:

- The R&S SMBV100B generates a baseband signal
- A spectrum analyzer is connected to the R&S SMBV100B, the analyzed is configured, and measures the required signal characteristics.

To improve signal flatness

For a given baseband signal and RF frequency, perform the following:

1. In the block diagram, select "I/Q Mod > I/Q Settings > I/Q Modulator > On".

The I/Q modulator is enabled. Modulated is the internal baseband signal.

This mode generates flat signal but requires longer settling time and leads to signal interruption.

2. Select "Optimization Mode > High Quality"

Note:

Do not use the mode "I/Q Modulator > Optimization Mode > High Quality" in combination with the modes "RF Level > Setting Characteristics > Uninterrupted Level Settings/Strictly Monotone".

The high quality I/Q optimization leads to RF signal interruption. The requirements of the RF level modes "Uninterrupted Level Settings" and "Strictly Monotone" can not be fulfilled.

3. On a connected signal analyzer, monitor the signal characteristics.

To optimize the intermodulation characteristics of signal

For a given baseband signal and RF frequency, perform the following iterative steps:

1. In the block diagram, select "I/Q Mod > I/Q Settings > I/Q Modulator > On".

The I/Q modulator is enabled. Modulated is the internal baseband signal.

2. If activated, disable the "I/Q Wideband > Off".

3. Select "Baseband Gain = - 2 dB".

4. On a connected signal analyzer, monitor the signal distortion characteristics.

5. Vary the value of the parameter "Baseband Gain" until the maximal suppression of the intermodulation products is achieved.

To optimize the characteristics of signals with high adjacent channel power ratio (ACPR)

For a given baseband signal (e.g. a 3GPP signal) and RF frequency, perform the following iterative steps:

1. In the block diagram, select "I/Q Mod > I/Q Settings > I/Q Modulator > On".
The I/Q modulator is enabled. Modulated is the internal baseband signal.
2. Select "Baseband Gain = 6 dB".
3. On a connected signal analyzer, monitor the signal characteristics.
4. Vary the value of the parameter "Baseband Gain" until the maximal signal-to-noise ratio (SNR) is achieved.

To trigger the internal correction routine of the I/Q modulator

System error correction of the I/Q modulator permits precise and repeatable measurements.

If a temperature fluctuation of several degrees occurs, trigger the correction routine using the following:

- ▶ Select "I/Q Mod > I/Q Modulator > Adjust I/Q Modulator Current Frequency"

To generate a wideband modulation signal

1. In the block diagram, select "I/Q Mod > I/Q Settings > I/Q Modulator > On".

The I/Q modulator is enabled. Modulated is the internal baseband signal.

2. Select "I/Q Wideband > On".

The R&S SMBV100B shifts the switching frequencies of the lowpass filters in the output section and generates signal with higher I/Q modulation bandwidth.

The harmonic suppression, however, degrades.

6 Configuring the RF Signal

The vector signal generator R&S SMBV100B generates RF signals with outstanding spectral purity within the frequency range from 8 kHz up to 6 GHz and with adjustable signal level over a wide range.

In addition to these real-time CW signals, you can generate RF signals from predefined lists and sweep signals that vary according to the frequency or amplitude curves.

You can also apply versatile analog modulation types with definable characteristics.

The variably adjustable output level due to the built-in attenuator, allows you to vary the RF signal level over the full level range. There are different methods to improve signal performance and to optimize the signal quality for the particular application, or to increase the accuracy and reliability of the generated RF signal.

The R&S SMBV100B supports R&S NRP power sensors, e.g. to monitor the output level of the generator and to determine the level correction values for user correction lists.

Signal modes and characteristics

The R&S SMBV100B generates unmodulated or analog modulated RF signals. You can output the signal in fixed mode or as a signal having periodically varying frequencies or amplitudes.

Signal modes for RF signal generation:

- Unmodulated signal
Generates an unmodulated continuous wave (CW) of constant frequency and amplitude.
For information on the signal frequency and level settings and example on how to configure a simple CW signal, see:
 - [Chapter 6.5, "RF Frequency Settings"](#), on page 263
 - [Chapter 6.6, "RF Level Settings"](#), on page 266
 - [Chapter 2.3.1, "Generating an Unmodulated Carrier"](#), on page 52
- Analog modulated signal
Modulates the signal with an analog signal and generates amplitude, phase, frequency and pulse modulation.

See [Chapter 6.11, "Analog Modulations"](#), on page 319.

- Vector modulated signal
Generates an I/Q vector modulated signal
See [Chapter 5, "Applying I/Q Vector Modulation"](#), on page 251.

The R&S SMBV100B allows you to provide the RF signal with constant or varying frequencies and/or amplitudes at the output:

- Constant frequency and level (CW/Fixed mode)
The RF output signal has the set frequency and level.
- Varying frequency and/or level
 - Sweep mode

An RF or LF frequency and RF level sweep signal, processed continuously, step-by-step or individually and with selectable trigger modes. You can only run one sweep at a time.

- List mode
The RF signal is based on a list of predefined frequency and level values pairs and step widths.

See [Chapter 6.10, "Varying the RF Signal in List or Sweep Mode"](#), on page 284.

6.1 Required Options

The equipment layout for generating the RF signal includes:

- Base unit
- Option frequency (R&S SMBVB-B103/-KB106) for signal path A

6.2 How to Access the RF Settings



Access:

1. In the block diagram, select the block "RF > RF".
2. Select the required function form the list.

The RF block comprises all functions and settings concerning the RF signal. These include the RF frequency and level settings with all enhanced functions for improving the signal characteristics, the analog modulations, list and sweep mode settings as well as connector assignments and measurement functions of the RF signal.

6.3 How to Activate the RF Signal Output

Per default, the RF output signal is deactivated. The previous state is restored when the signal is reactivated.

To activate the RF output

1. Configure the RF signal as required.
Set, for example, the frequency and level values.
2. Activate the RF output in one of the following ways:
 - a) Select "Level > RF ON > On"
 - b) Press the [RF on/off] key at the front panel.

3. In the block diagram, observe the color of the "RF On" icon.

The blue color indicates that the RF output is activated.

RF State/RF ON.....	262
RF output impedance.....	262

RF State/RF ON

Activates or deactivates the RF output.

Acts as the [RF on/off] key.

Remote command:

`:OUTPut<hw>[:STATe]` on page 618

RF output impedance

You can query the impedance of the RF output.

Remote command:

`:OUTPut<hw>:IMPedance?` on page 618

6.4 How to Set the Frequency and Level

The simplest form of the RF signal is a continuous wave (CW) of constant frequency and amplitude. The RF signal is defined by its frequency, level and phase.

► Use one of the following:

- "Status Bar > Frequency and Level"
- "Status Bar" > underlined label **Frequency** or **Level**
- "RF > RF Frequency > Frequency > Frequency"
- "RF > RF Level > Level > Level"
- "RF > RF Frequency > Phase"
- "Block diagram" > underlined label **RF** > "RF Frequency > Frequency > Frequency", etc.
- On the front panel, press the [Freq] or the [Level] key.

Current frequency and level values are indicated on the "Status bar" so that you can see them at a glance. Values displayed in the status bar and in the "Frequency/Level" dialogs can deviate from each other.

See "[RF frequency and level display with a downstream instrument](#)" on page 262.

RF frequency and level display with a downstream instrument

If your test setup includes a downstream instrument, you can enter the parameter of the downstream instrument in the frequency or level settings dialog of the R&S SMBV100B. Examples of downstream instruments are mixers, frequency multipliers, amplifiers or attenuators and of their corresponding major parameters offset, multiplier, amplitude. The R&S SMBV100B generates the signal without the downstream

parameters, but considers all additional parameters concerning the frequency and level.

Example parameters that affect the frequency and level:

- Frequency offset
- Multiplication factor
- User correction
- Digital attenuation

Any of these cases are indicated by a dedicated icon in the status bar, depending on the affected parameter.

Figure 6-1 illustrates the calculation of the "Frequency" and "Level" values, displayed in the status bar.

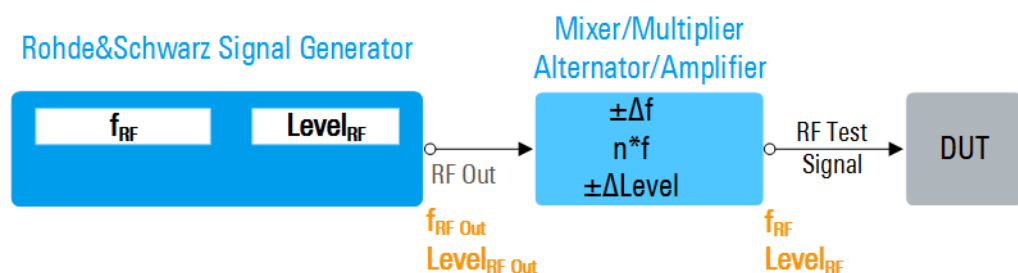

Figure 6-1: Frequency and Level display vs frequency and level at the RF output

f_{RF} , $Level_{RF}$	= Frequency and level ("Status bar > Frequency and Level") at the output of the downstream instrument, see also Calculation of f_{RF} and $Level_{RF}$
$f_{RF\ Out}$, $Level_{RF\ Out}$	= Frequency and level at the output connector [RF] ("RF > RF Frequency > Frequency" and "RF > RF Level > Amplitude")
$n*f$	= Multiplication factor ("RF > RF Frequency > Multiplier")
Δf	= Frequency offset ("RF > RF Frequency > Offset")
$\Delta Level$	= Power offset ("RF > RF Level > Offset")

Calculation of f_{RF} and $Level_{RF}$

- $f_{RF} = n * f_{RF\ Out} + \Delta f$
- $Level_{RF} = Level_{RF\ Out} + \Delta Level + Level_{DigAtt}$
($Level_{DigAtt}$ for active internal I/Q modulation, "RF > RF Level > Digital Attenuation")

6.5 RF Frequency Settings

Access:

- ▶ Select "RF" > "RF Frequency" > "Frequency".



In the "RF Frequency" dialog, you can configure:

- RF frequency, incl. an offset or multiplication factor of a downstream instrument
- The step size for varying the frequency with the rotary knob.

The remote commands required to define the settings are described in [Chapter 12.16.6, "SOURCE:FREQUENCY Subsystem"](#), on page 812.

Settings

Frequency..... 264
 Offset.....265
 Multiplier.....265
 User Variation.....265
 L Variation Active..... 265
 L Variation Step.....265

Frequency

Sets the RF frequency.

This frequency is output at the RF connector. It does not consider an [Offset](#) or multiplication factor ([Multiplier](#)).

See "[RF frequency and level display with a downstream instrument](#)" on page 262.

Note: Suppressed values in the status bar

For security concerns or certain operating modes, you can hide the frequency and level display in the status bar.

- *********

The display has been disabled for security reasons.

See:

- [Annotation Frequency](#)
- [Annotation Amplitude](#)

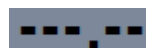

The display is disabled when:

- List mode is running, see [Chapter 6.10, "Varying the RF Signal in List or Sweep Mode"](#), on page 284.

Remote command:

`[:SOURce<hw>] :FREQuency [:CW | FIXed]` on page 816

Offset

Sets the frequency offset.

This value represents the frequency shift of a downstream instrument, like for example a mixer.

The "Frequency" value displayed in the status bar is the resulting frequency, as it is at the output of the downstream instrument. The frequency at the R&S SMBV100B RF output is not changed.

See ["RF frequency and level display with a downstream instrument"](#) on page 262.

Remote command:

`[:SOURce<hw>] :FREQuency:OFFSet` on page 818

Multiplier

Sets the multiplication factor for the RF frequency.

This value represents the multiplication factor of a downstream instrument, like for example a multiplier.

The "Frequency" value displayed in the status bar is the resulting frequency, as it is at the output of the downstream instrument. The frequency at the R&S SMBV100B RF output is not changed.

See ["RF frequency and level display with a downstream instrument"](#) on page 262.

Remote command:

`[:SOURce<hw>] :FREQuency:MULTiplier` on page 818

User Variation

Defines and activates a user-defined step width for varying the RF frequency or RF level with the rotary knob.

If disabled, the step width varies in steps of one unit at the cursor position.

Variation Active ← User Variation

Activates the set user-defined step width.

Remote command:

`[:SOURce<hw>] :FREQuency:STEP:MODE` on page 820

`[:SOURce<hw>] :POWer:STEP:MODE` on page 866

Variation Step ← User Variation

Sets the user-defined step width.

Remote command:

`[:SOURce<hw>] :FREQuency:STEP [:INCRement]` on page 821

`[:SOURce<hw>] :POWer:STEP [:INCRement]` on page 867

6.6 RF Level Settings

Access:

1. Select "RF" > "RF Level" > "Level".



In the "RF Level" dialog, you can configure the offset-free level, the level limit, and the step width for varying the level with the rotary knob.

2. Select "User Variation" to set the step width to be used when setting the RF level using the rotary knob.

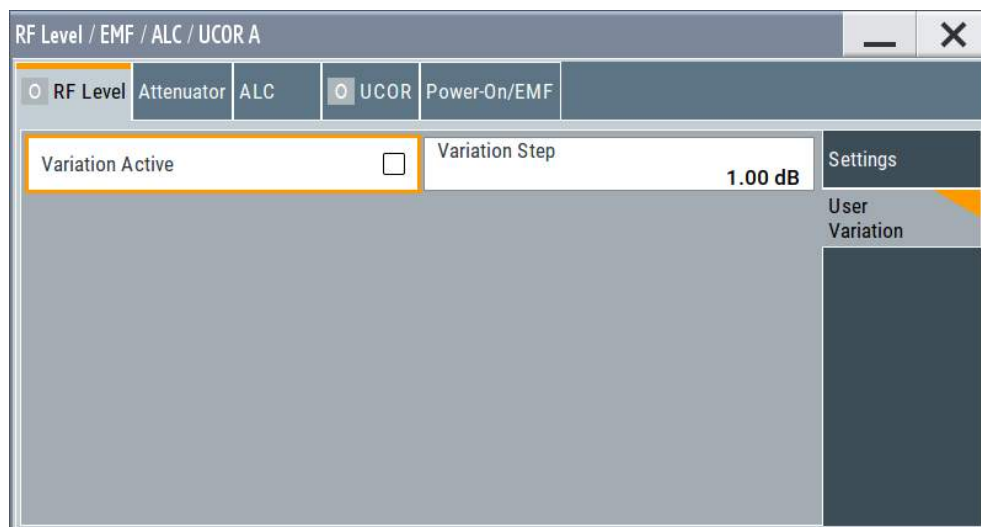

The remote commands required to define the settings are described in [Chapter 12.16.15, "SOURCE:POWER Subsystem"](#), on page 859.

Settings

Amplitude.....	267
Limit	267
Offset	268
Digital Attenuation.....	268
Setting Characteristics	268
Mode	269
Level Range	269
Readjust.....	270
User Variation.....	270
L Variation Active.....	270
L Variation Step.....	270

Amplitude

Sets the level of the RF signal.

The value is offset-free and corresponds to the level at the RF connector.

See "RF frequency and level display with a downstream instrument" on page 262.

Note: Suppressed values in the status bar

For security concerns or certain operating modes, you can hide the frequency and level display in the status bar.

- *********

The display has been disabled for security reasons.

See:

- [Annotation Frequency](#)
- [Annotation Amplitude](#)

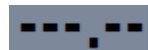

The display is disabled when:

- List mode is running, see [Chapter 6.10, "Varying the RF Signal in List or Sweep Mode"](#), on page 284.

Remote command:

`[:SOURce<hw>] :POWer :POWer` on page 865

Note: The SCPI command `[:SOURce<hw>] :POWer [:LEVel] [:IMMediate] [:AMPLitude]` sets the level of the "Level" display.

This means, the level containing offset.

Limit

Sets an upper limit for the RF output power.

You can use this value to protect your DUT from damage due to high input power. If you enter an RF level above this value, the instrument limits the output power to this specified value, and generates the warning message:

"Pep value greater than the defined limit." However, the level indication in the status bar is not affected.

The setting is not affected by an instrument preset ([Preset] key or *RST) and the "Save/Recall" function. It is reset only by factory preset.

Remote command:

`[:SOURce<hw>] :POWer:LIMit [:AMPLitude]` on page 863

Offset

Sets a level offset.

This value represents the level shift of a downstream instrument, like, for example, an attenuator or an amplifier.

The "Level" value displayed in the status bar is the resulting level, as it is at the output of the downstream instrument. The level at the R&S SMBV100B RF output is not changed.

See ["RF frequency and level display with a downstream instrument"](#) on page 262.

Remote command:

`[:SOURce<hw>] :POWer [:LEVel] [:IMMediate] :OFFSet` on page 867

Digital Attenuation

Attenuates or raises the level of the internal, digitally modulated I/Q baseband signals, and thus the level of the RF signal accordingly.

The function allows fast level changes of the internal I/Q signals. You can determine an attenuation value between -3 dB and +80 dB. The instrument calculates the digital attenuation to the $Level_{PEP}$ and the $Level_{rms}$ as follows:

$$Level_{PEP(RF\ output)} = Level_{PEP} - \text{Digital Attenuation}$$

$$Level_{rms(RF\ output)} = Level_{rms} - \text{Digital Attenuation}$$

The level range changes accordingly.

Note: The digital attenuation has no effect on the RF output level when you work in CW mode or with externally applied I/Q signals, i.e. with unmodulated signals. If the digital attenuation affects the RF level, the R&S SMBV100B indicates the resulting level in the "Status bar". It is also denoted by an icon next to the level indicator.

Note also that several other parameters affect the displayed RF level value.

See ["RF frequency and level display with a downstream instrument"](#) on page 262.

Remote command:

`[:SOURce<hw>] :POWer:ATTenuation:DIGital` on page 862

Setting Characteristics

Selects additional quality characteristics to optimize the behavior of the RF signal level for the corresponding application.

- | | |
|--------|---|
| "Auto" | Sets the RF output level automatically according to the selected mode.
In this mode, the instrument provides the highest dynamic range and fastest setting times, as specified in the data sheet.
The RF signal is shortly blanked when the step attenuator is switching. |
|--------|---|

"Uninterrupted Level Settings"

Suppresses blanking at level transitions. Frequency transitions can lead to an RF level blanking due to hardware specific switching points.

This mode reduces the dynamic range of the instrument. The step attenuator is fixed.

Note:

Do not use the mode "I/Q Modulator > Optimization Mode > High Quality" in combination with the modes "RF Level > Setting Characteristics > Uninterrupted Level Settings/Strictly Monotone".

The high quality I/Q optimization leads to RF signal interruption. The requirements of the RF level modes "Uninterrupted Level Settings" and "Strictly Monotone" can not be fulfilled.

"Strictly Monotone"

Executes signal level changes monotonically increasing or decreasing.

The setting makes sure that increasing the level value exclusively results in an increased output level, and vice versa.

All electronic switches, which might affect the monotonicity are fixed. The operation mode is useful for applications using level searching algorithms which rely on a strictly monotonous behavior.

"Constant-VSWR"

Suppresses output impedance variations at the RF output connector, due to changed level settings.

"User"

Indicates that a setting has been modified in the expert mode. The expert mode is a protected function, that requires protection level 2 password.

Remote command:

`[:SOURce<hw>] :POWer:LBEHaviour` on page 863

Mode

Allows you to optimize the RF output signal for applications, where improved harmonic distortion or improved wideband noise is required.

"Normal" Generates an RF output signal with high signal to noise ratio as well as low distortion, according to the data sheet.

"Low Noise" Optimizes the signal to noise ratio.

"Low Distortion" Reduces distortion (harmonics) of the RF signal to a minimum.

Remote command:

`[:SOURce<hw>] :POWer:LMODe` on page 864

Level Range

Shows the interruption-free range of the level that you can use in the currently selected mode.

Remote command:

[:SOURce<hw>] :POWer:RANGe:LOWer? on page 869

[:SOURce<hw>] :POWer:RANGe:UPPer? on page 869

Readjust

Recalculates and adjusts the internal switch positions of the RF chain according to the current level.

In the "Sample & Hold" and "Sample & On" modes, the function also triggers a new sample process. During the recalculation, the output level is blanked briefly.

Remote command:

[:SOURce<hw>] :POWer:ALC:SONCe on page 861

User Variation

Defines and activates a user-defined step width for varying the RF frequency or RF level with the rotary knob.

If disabled, the step width varies in steps of one unit at the cursor position.

Variation Active ← User Variation

Activates the set user-defined step width.

Remote command:

[:SOURce<hw>] :FREQuency:STEP:MODE on page 820

[:SOURce<hw>] :POWer:STEP:MODE on page 866

Variation Step ← User Variation

Sets the user-defined step width.

Remote command:

[:SOURce<hw>] :FREQuency:STEP [:INCReMENT] on page 821

[:SOURce<hw>] :POWer:STEP [:INCReMENT] on page 867

6.7 RF Phase Settings

The phase in sinusoidal signals defines the initial angle at its origin.

Access:

- ▶ Select "RF" > "RF Frequency" > "Phase".

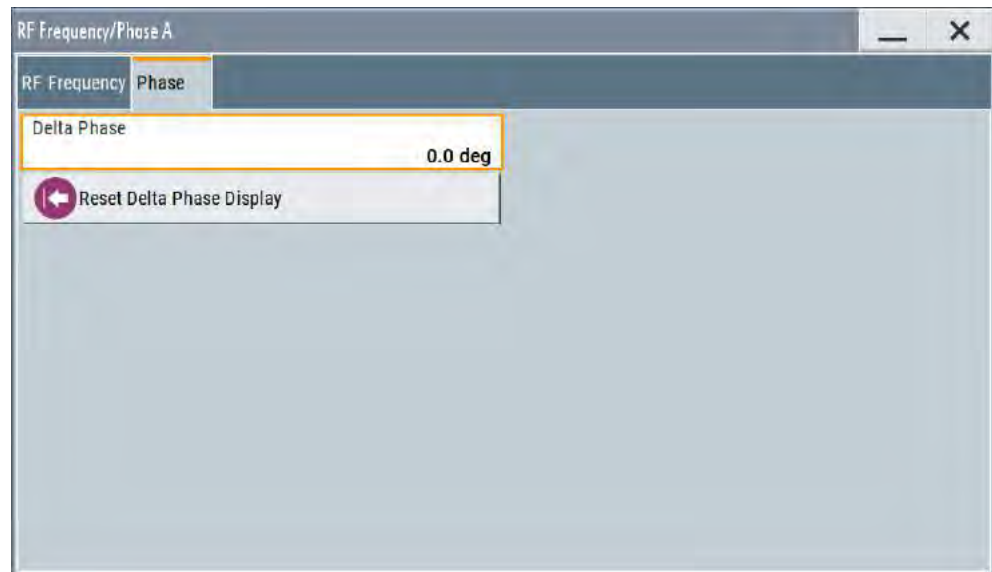

In the "RF Phase" tab, you can determine the delta phase value and reset the phase to this reference.

The remote commands required to define the settings are described in [Chapter 12.16.14, "SOURCE:PHASe Subsystem"](#), on page 858.

Settings

Delta Phase	271
Reset Delta Phase Display	271

Delta Phase

Sets the phase of the RF signal.

The current phase of the signal is used as the reference.

Note: Achieving long-term stable phase-locked coupling. We recommend that you use the LO coupling feature, if you try to synchronize the output signal with the phase of a second signal generator for example.

See [Chapter 6.9, "Local Oscillator Coupling"](#), on page 279.

Remote command:

[:SOURCE<hw>] : PHASe on page 859

Reset Delta Phase Display

Adopts the selected "Delta Phase" value as the current value, and resets delta phase to 0 degrees.

Remote command:

[:SOURCE<hw>] : PHASe : REFERENCE on page 859

6.8 Reference Oscillator

The R&S SMBV100B is equipped with an internal reference oscillator that generates a reference frequency of 10 MHz. It is used as internal reference source for the synthesizer. Alternatively, you can apply an external reference signal. If equipped with the required options, the R&S SMBV100B can process external reference frequency in the range 1 MHz to 100 MHz and the 1 GHz reference frequency.

Regardless of the used reference source (internal or external), the R&S SMBV100B always outputs the reference frequency at the output connector. You can use it, for example to synchronize further connected instruments.

See:

- **Data sheet**, for a comprehensive description of the possible reference frequency inputs and outputs, their characteristics and the required options
- [Chapter 6.8.2, "Using the Reference Frequency for Instruments Synchronization"](#), on page 272, for an overview of typical test situations

The reference oscillator settings are not affected by an instrument preset ([Preset] key or *RST) and the "Save/Recall" function. They are reset only by factory preset.

The remote commands required to define these settings are described in [Chapter 12.16.16, "SOURCE:ROSCillator Subsystem"](#), on page 869.

6.8.1 Required Options

R&S SMBV100B base unit equipped with the following options:

- Reference oscillator (R&S SMBVB-B1)
- 1 GHz reference (R&S SMBVB-B3)

For more information, see data sheet.

6.8.2 Using the Reference Frequency for Instruments Synchronization

Test setups with two or more instruments often require that the instruments use a common reference frequency. Depending on the availability of external reference frequency source and its quality, the instruments are connected and configured in different ways.

This section gives an overview of the possible test setups and the related settings. The following situations are considered:

- External reference source is not available or the **built-in reference oscillator** is of better quality than the external source
(see ["Distributing the internal 10 MHz reference signal to further instruments"](#) on page 273)
- **Clean external reference source** with quality exceeding the quality of the built-in reference oscillator
(see ["Using external reference source"](#) on page 273)
- **Interfered or noisy external reference signal**

(see "Deriving 10 MHz from the external reference frequency" on page 274)

- **1 GHz reference coupling** for phase coherence of the RF signals with reasonable long-term phase stability
(see "Sharing the 1 GHz reference frequency to obtain phase-coherent signals" on page 273)

Connectors overview

Use the "Show Connector" function to indicate the connector on the front/real panel:

- Ref In/Ref Out
- Ref In/Ref Out 1GHz

Distributing the internal 10 MHz reference signal to further instruments

The internal reference oscillator provides the reference frequency:

- Internal $f_{\text{ref}} = 10 \text{ MHz}$ (10 MHz at connector Ref Out)
- **Source** = "Internal"
- **Reference Output/1GHz Reference Output** = "10 MHz"

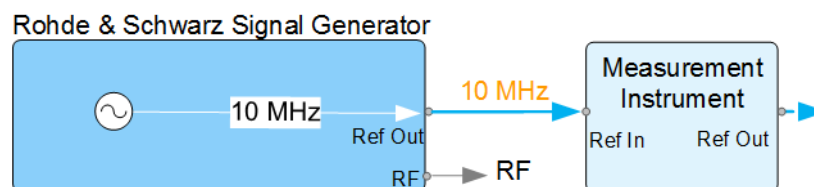

Figure 6-2: Synchronizing instruments using the internal 10 MHz reference signal of the R&S SMBV100B

Ref In, Ref Out = Connectors

Sharing the 1 GHz reference frequency to obtain phase-coherent signals

Compared to 10 MHz, a 1 GHz reference signal significantly improves the achievable phase stability between two signal sources. Because the synchronization increases by a factor of 100, the relative phase fluctuations between the sources can be reduced.

1 GHz at connector Ref In 1GHz and 1 GHz at Ref Out 1GHz

- External $f_{\text{Ref}} = 1 \text{ GHz}$
- **Source** = "External"
- **External Reference Frequency** = "1 GHz"
- **1GHz Reference Output** = "1 GHz"

Using external reference source

If you have a clean external reference signal with 10 MHz or 100 MHz frequency, for example, you can **directly pass it to the output**. The signal quality remains the same.

10 MHz/100 MHz at connector Ref Out and Ref In

- External $f_{\text{Ref}} = 10 \text{ MHz}$ or 100 MHz
- **Source** = "External"

- **Reference Output** = "10 MHz/100 MHz" or "Input Signal (loop through)"
- Set the synchronization bandwidth according to the requirements of the application.

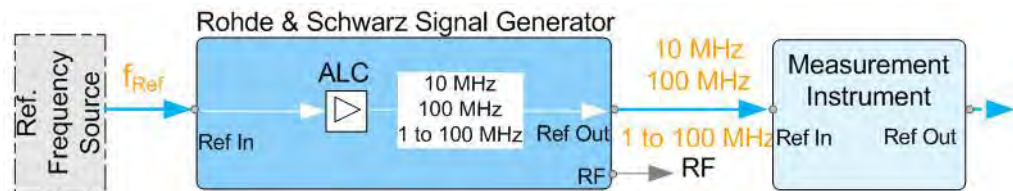

Figure 6-3: Synchronizing instruments with a 10 MHz external reference signal

Ref. Frequency Source = e.g. Rohde & Schwarz signal analyzer

f_{Ref} = 10 MHz/100 MHz/1 to 100 MHz external reference frequency

Ref In, Ref Out = Connectors

You can forward reference frequency between 1 MHz and 100 MHz directly to the output in the same way.

- External f_{Ref} = 1 MHz to 100 MHz
(**1 MHz to 100 MHz at connector Ref In and Ref Out**)
- **Source** = "External"
- **Variable Reference Frequency** = "Variable"
- **External Reference Frequency** = current external frequency
- **Reference Output** = "Input Signal (loop through)" or specify the reference frequency the synchronized instrument supports
- Set the synchronization bandwidth according to the requirements of the application.

Deriving 10 MHz from the external reference frequency

10 MHz reference frequency can be derived from the following external reference signals:

- 10 MHz from internal oscillator locked to external input
- 100 MHz and 1 GHz external reference signals
- External reference signal between 1 MHz and 100 MHz
- If the external reference signal is interfered (noisy)

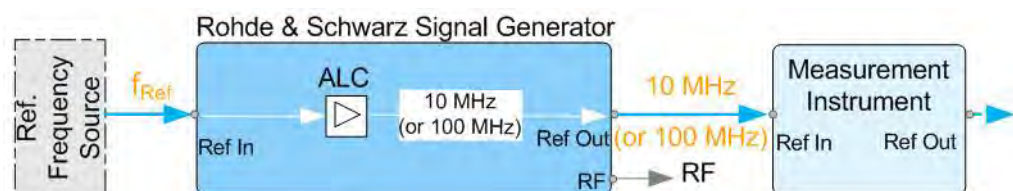

Figure 6-4: Synchronizing instruments with 10 MHz (derived from an external reference frequency)

Ref. Frequency Source = e.g., Rohde & Schwarz signal analyzer

f_{Ref} = 10 MHz/100 MHz/1 to 100 MHz/1GHz** external reference frequency

** = 1 GHz uses Ref In 1 GHz connector

Ref In, Ref Out = Connectors

1 GHz/1 to 100 MHz at connector Ref In 1 GHz/Ref In and 10 MHz at Ref Out

- E.g., External Ref. $f_{ref} = 100 \text{ MHz}$
- Source = "External"
- External Reference Frequency = "100 MHz"
- Reference Output/1GHz Reference Output = "10 MHz"
- Synchronization Bandwidth = "Narrow"

6.8.3 Reference Frequency Settings

Access:

1. Select one of the following:
 - "RF" > "Reference Frequency"
 - "System Config" > "Setup" > "General" > "Reference Frequency"

Reference Frequency	Reference Output	Adjustment	LO Coupling
<div style="display: flex; justify-content: space-between;"> ← Set To Default Show Connector ... </div>			
Source	External		
Deactivate RF Output <small>(if external reference is missing)</small>	<input checked="" type="checkbox"/>		
External Reference Frequency	Variable	Variable Reference Frequency	1.002 000 0 MHz
Nominal Synchronization Bandwidth	3 Hz	Minimum Locking Range	+/- 0.3 ppm

In the "Reference Frequency" tab, you can select the signal source of the reference frequency and define the frequency of an external reference signal.

2. Observe the information in the status bar of the block diagram.

The status bar indicates the current oscillator configuration.



The remote commands required to define these settings are described in [Chapter 12.16.16, "SOURCE:ROSCillator Subsystem"](#), on page 869.

Settings:

Set to Default.....	276
Source.....	276
Show Connector.....	276
Deactivate RF Output (if external reference is missing).....	276
External Reference Frequency.....	276
Variable Reference Frequency.....	277

Synchronization Bandwidth.....	277
Nominal Synchronization Bandwidth.....	277
Minimum Locking Range.....	277

Set to Default

Calls the default settings.

Remote command:

`[:SOURce] :ROSCillator :PRESet` on page 870

Source

Selects the reference frequency source.

"Internal" Uses the internal reference oscillator, either with calibrated or a user-defined adjustment value.

"External" Uses an external reference signal.
The frequency of the external reference signal must be set with the parameter "External Reference Frequency".

Note: If the external reference is missing, the R&S SMBV100B issues a warning message and indicates the icon  (external reference missing).

See "[External Reference Frequency](#)" on page 276.

Remote command:

`[:SOURce] :ROSCillator :SOURce` on page 870

**Show Connector**

Accesses a dialog that displays the physical location of the selected connector on the front/rear panel of the instrument.

Deactivate RF Output (if external reference is missing)

Turns off the RF output when the external reference signal is selected, but no signal is supplied.

This function prevents that no improper RF signal due to the missing external reference signal is used for measurements. A message indicates that the RF output is deactivated.

Remote command:

`[:SOURce] :ROSCillator :EXTernal :RFOff [:STATe]` on page 871

External Reference Frequency

Sets the frequency of the external reference signal.

"Variable" Option: R&S SMBVB-K704

The external reference signal has an arbitrary frequency, within the permissible range from 1 MHz to 100 MHz.

Set the output frequency with the parameters in the [Reference Output](#) dialog.

"10 MHz, 100 MHz, 1GHz"

Selects the external reference frequency.

Option: R&S SMBVB-B3 for 1 GHz.

Remote command:

[\[:SOURce\]:ROSCillator:EXTernal:FREQuency](#) on page 871

Variable Reference Frequency

Option: R&S SMBVB-K704

Sets the variably settable external reference frequency.

Remote command:

[\[:SOURce\]:ROSCillator:EXTernal:FREQuency:VARiable](#) on page 871

Synchronization Bandwidth

("External Reference Frequency = 10 MHz, 100 MHz or 1 GHz")

Selects the synchronization bandwidth for an external reference signal.

The resulting bandwidth is indicated with the parameter [Nominal Synchronization Bandwidth](#).

"Narrow" The internal reference oscillator is synchronized to the external signal with narrow bandwidth (< 1 Hz). This setting is recommended if the phase noise of the external signal is worse than the phase noise of the internal OCXO.

"Wide" This mode is the recommended standard mode and for precise reference sources of high spectral purity.

Remote command:

[\[:SOURce\]:ROSCillator:EXTernal:SBANdwidth](#) on page 872

Nominal Synchronization Bandwidth

Indicates the nominal synchronization bandwidth for the selected external reference frequency and synchronization bandwidth.

Remote command:

[\[:SOURce\]:ROSCillator:EXTernal:NSBandwidth?](#) on page 872

Minimum Locking Range

Indicates the minimum locking range for the selected external reference frequency.

Remote command:

[\[:SOURce\]:ROSCillator:EXTernal:MLRange?](#) on page 872

6.8.4 Reference Output Settings

Access:

1. Select "RF" > "Reference Frequency"

2. Select "Reference Output".

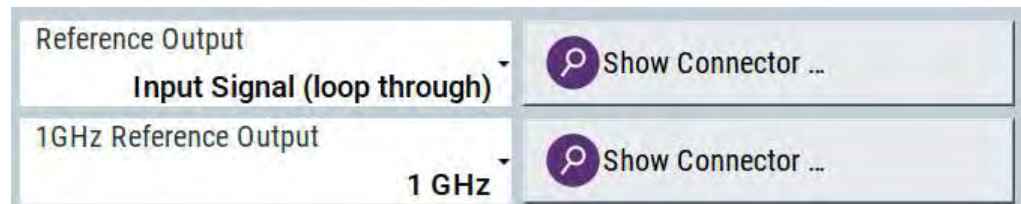

In the "Reference Output" tab, you can set the reference frequency value at the output connectors.

As a result of parameter dependencies, "Preset This Parameter" sometimes does not affect output dialogs.

The remote commands required to define these settings are described in [Chapter 12.16.16, "SOURce:ROSCillator Subsystem"](#), on page 869.

Settings:

Reference Output/1GHz Reference Output	278
Show Connector	278

Reference Output/1GHz Reference Output

Selects the signal that is to be output as frequency reference for downstream instruments.

"Off"	Disables the reference signal output.
"10 MHz"	Derives a signal with 10 MHz frequency from the internal reference oscillator and forwards this signal to the output.
"1 GHz"	Option: R&S SMBVB-B3 Outputs a 1 GHz signal.
"Input Signal (loop through)"	Forwards the external reference frequency to the output directly.

Remote command:

[\[:SOURce\]:ROSCillator:OUTPut:FREQuency:MODE](#) on page 872

[\[:SOURce\]:ROSCillator:OUTPut:ALternate:FREQuency:MODE](#) on page 873



Show Connector

Accesses a dialog that displays the physical location of the selected connector on the front/rear panel of the instrument.

6.8.5 Adjustment Settings

Access:

1. Select "RF" > "Reference Frequency"
2. Select "Adjustment".

Adjustment Active <input checked="" type="checkbox"/>	Adjustment Value	0
---	------------------	---

Settings:

Adjustment Active.....	279
Adjustment Value.....	279

Adjustment Active

Selects the adjustment mode.

- | | |
|-------|--|
| "OFF" | Uses the calibrated internal reference frequency. |
| "ON" | Allows you to apply a deviation to the internal reference frequency, according to your requirements.
Enter the value in the Adjustment Value field. |

Remote command:

[\[:SOURce\]:ROSCillator\[:INTernal\]:ADJust\[:STATe\]](#) on page 874

Adjustment Value

Sets a user-defined adjustment value for the internal reference frequency. This value takes effect when it is activated with [Adjustment Active](#).

- "0" represents the calibrated state.
- The setting range depends on the reference oscillator type and its factory calibration value.

Note:

The setting is not affected by an instrument preset ([Preset] key or *RST) and the "Save/Recall" function. It is reset only by factory preset.

Remote command:

[\[:SOURce\]:ROSCillator\[:INTernal\]:ADJust:VALue](#) on page 873

6.9 Local Oscillator Coupling

The "LO Coupling" function allows a distribution of the local oscillator signal in a way that multiple RF signals can be derived from the same LO signal. Derivation from the same LO signal is mandatory for minimizing the phase fluctuations between these RF signals.

The R&S SMBV100B uses either the internal oscillator frequency for the LO signal, that is the output signal of the internal synthesizer, or an external frequency source.

Connectors

- The internal LO signal is output at the LO Out connector.
- An external signal is fed in at the LO In connector.



The instrument cannot verify the frequency of the oscillator signal that is fed in. We recommend that you feed in signal with exactly the same frequency as shown in the settings dialog, see [LO OUT Frequency](#).

See also "[To find the physical Location of the LO In/Out connectors](#)" on page 282.

6.9.1 Required Options

The equipment layout for using the LO coupling function includes:

- Base unit
- Option phase coherence (R&S SMBVB-K90)

6.9.2 Phase Coherence

Phase coherence of RF signals designates a defined, constant delta phase between two or more RF carrier signals with the same frequency or a multiple of the frequency.

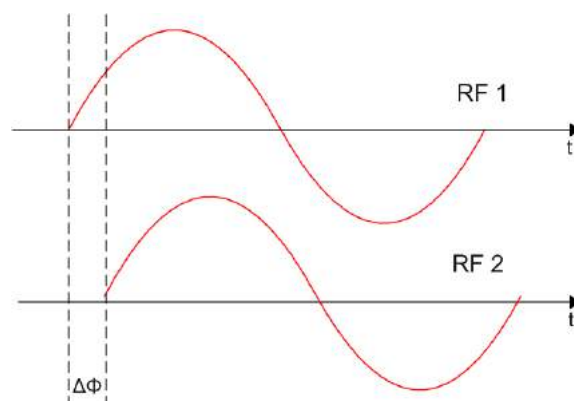

If two signal generators are coupled via their 10 MHz reference, they are generating the same frequency but only from the long term perspective. Having a closer look into the instantaneous differential phase (“delta phase”) of these two RF signals, the following are possible causes for instabilities:

- Phase noise of the two synthesizers
- *Weak* coupling at 10 MHz and a long synthesis chain up to the RF domain
- Temperature differences which cause a change of the effective electrical length of some synthesizer components

Most critical for a stable delta phase is the thermal RF phase fluctuation between multiple RF synthesizers. These fluctuations can be minimized by using a common synthesizer, that means a common local oscillator (LO) signal for all RF carrier. The LO signal is internally used for upconverting the baseband signal to the RF. Only if the LO signal is the same for all carriers, you can achieve a stable phase relationship between the RF signals.

6.9.3 LO Coupling Settings

Access:

- ▶ Select "RF" > "LO Coupling ...".

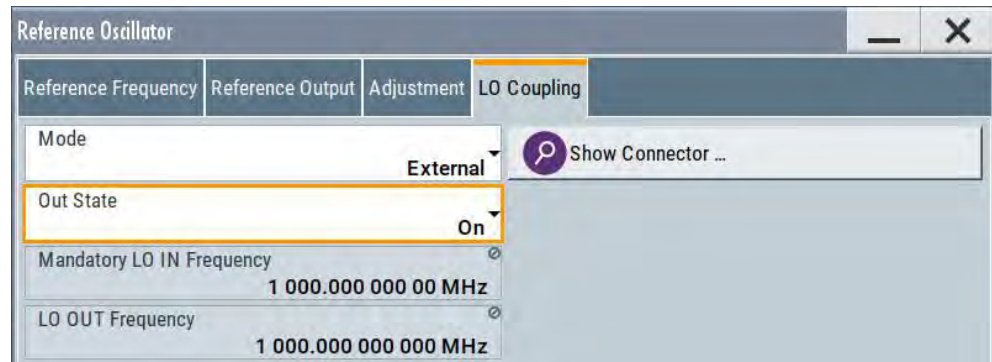

The "Local Oscillator (LO) Coupling" settings enable you to define the coupling of the local oscillator signal in the RF signal paths.

The related remote commands are described in [Chapter 12.16.6, "SOURCE:FREQUENCY Subsystem"](#), on page 812.

Mode

Selects the coupling mode of the LO signals.

See a typical test setup in [Chapter 6.9.4, "How to Configure Cascaded Instruments"](#), on page 282.

Note: Working with an **external** oscillator signal disables all setting parameters of the "RF Frequency / Phase / Ext. Reference" dialog.

In **external** mode with active **Out State**, the LO coupling mode is defined within an RF frequency range of 80 MHz to 6 GHz. If you set the RF frequency below 80 MHz, the R&S SMBV100B adjusts the frequency to the minimum value and displays a corresponding message.

"Internal" Uses the internal signal.

"External" Uses an externally supplied signal.

Remote command:

`[:SOURCE<hw>] :FREQUENCY:LOSCillator:MODE` on page 815.

Out State

Activates or deactivates the LO output.

"On" Switches the LO output signal on.

For coupling two instruments, the internal local oscillator signal is also available at the LO Out connector.

"Off" Switches the LO output signal off.

Remote command:

`[:SOURCE<hw>] :FREQUENCY:LOSCillator:OUTPut:STAtE` on page 815

Mandatory LO IN Frequency

Displays the frequency that must be applied as external LO frequency.

Remote command:

[\[:SOURce<hw>\]:FREQuency:LOSCillator:INPut:FREQuency?](#) on page 814

LO OUT Frequency

Displays the current LO frequency at the LO Out connector.

Remote command:

[\[:SOURce<hw>\]:FREQuency:LOSCillator:OUTPut:FREQuency?](#) on page 815

**Show Connector**

Accesses a dialog that displays the physical location of the selected connector on the front/rear panel of the instrument.

6.9.4 How to Configure Cascaded Instruments

This section describes how you can find out the location of the LO signal connectors (LO In/Out). You can also find instructions for configuring the LO signals of several disconnected signal generators.

To find the physical Location of the LO In/Out connectors

The LO In and LO Out connectors are located on the rear panel. To find out the exact position, proceed as follows:

1. In the block diagram, select the "T/E/P/L/V" status indication field above the "RF" block.
2. Select "LO In" > "Show".
3. Observe the connectors's position on the "Rear" panel.

See also [Chapter 10.2.4, "RF Connectors Settings"](#), on page 490.

To configure LO coupling with cascaded instruments to achieve phase coherence

The LO Coupling function can be used to generate beamforming signals.

The test setups in the following examples represent possible applications and provide information about the coupling modes set in the signal generators. For the configuration via remote control, see the examples in [Chapter 12.16.6, "SOURce:FREQuency Subsystem"](#), on page 812.

The first test setup example represents all variants of the coupling modes, and describes step-by-step how to configure each of the Rohde & Schwarz signal generators. The following examples show further conceivable test setups. To configure these test setups, proceed similarly as shown in the first example.

Example: Cascading three Rohde & Schwarz Signal Generators

Figure 6-5: Set up of LO coupling with three Rohde & Schwarz Signal Generators

Generator 1 = "Internal"; "LO Out > Off"

Generator 2 = "A External & A->B Coupled"; "LO Out > On"

Generator 3 = "External"; "LO Out > Off"

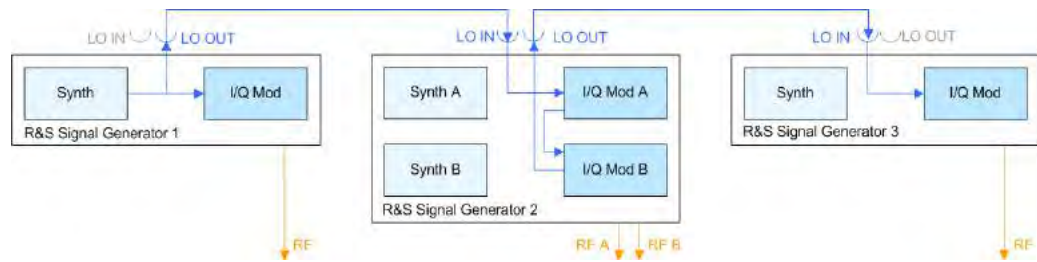
A frequency of 5 GHz is assumed.

- Signal Generator 1 is a one-path instrument, for example R&S SMBV100B and uses its internal oscillator signal.
- Signal Generator 2 is a two-paths instrument, for example a R&S SMW200A. It receives the LO signal from the first instrument and assigns it to both paths.
- Signal Generator 3 is a one-path instrument, for example R&S SMBV100B, R&S SGT100A, or R&S SMBV100A. It receives the LO signal from the second instrument.

To configure the application, proceed as follows:

1. Connect the first signal generator Ref Out with LO In of the second instrument, and similarly the LO Out of the second signal generator with LO In of the third.
2. Configure **Signal Generator 1**.
Select "Freq = 5 GHz".
 - a) Select "RF > LO Coupling > Mode > Internal".
 - b) Set "Out State > On".
3. Configure **Signal Generator 2**.
 - a) Set "Freq => 5 GHz".
 - b) Check if both paths are able to deal with the desired RF frequency.
 - If both paths can handle the RF frequency, select "RF > LO Coupling > Mode > A External & A->B Coupled"
 - If path A is not sufficiently equipped, select "RF > LO Coupling > Mode > A RF Off & B External"
 - If path B is not able to handle the frequency, select "RF > LO Coupling > Mode > A External & B RF Off"
 - c) Set "Out State > On".

- d) If the attenuation between the interconnection LO Out and LO In is more than 1 dB at the oscillator frequency, we recommend that you execute "Adjust LO Level Current Frequency".

Note: Complete the adjustment procedure before you perform the adjustment on a subsequent instrument.

The signal generator automatically adjusts the internal LO signal level at the I/Q modulator and LO Out connector.

4. Configure **Signal Generator 3**.

- a) Set "Freq = 5 GHz".
- b) Select "RF > LO Coupling > Mode > External".
- c) Set "Out State > Off".
- d) If the attenuation between the interconnection LO Out and LO In is greater than 1 dB at the oscillator frequency, we recommend that you perform level adjustment:

- Check if the "Adjust LO Level Current Frequency" procedure of the previous instrument is completed.
- Execute "Adjust LO Level Current Frequency".

The signal generator automatically adjusts the internal LO signal level at the I/Q modulator and LO Out connector.

All instruments generate the RF signals in phase, as they use the same oscillator signal looped through all instruments.

Example: Generating a beamformed signal with two one path Rohde & Schwarz Signal Generators

This example shows a test setup with two generators, each equipped with one path.

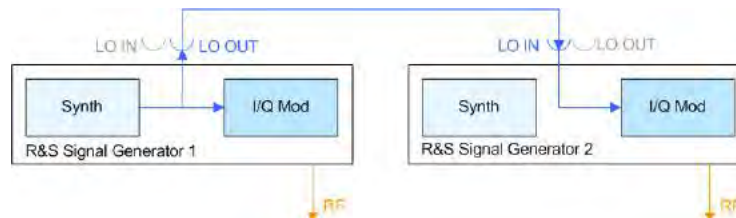

Generator 1 = "Internal"; "LO Out > On"
 Generator 2 = "External"; "LO Out > Off"

The *Signal Generator 1* uses its internal oscillator signal. *Signal Generator 2* receives the LO signal from the first instrument. The frequency is assumed to be 2 GHz.

6.10 Varying the RF Signal in List or Sweep Mode

The operating modes "List" and "Sweep" allow you to generate an RF signal having periodically varying frequencies or amplitudes.

A signal generated with varying parameters scans a certain range of varying values of a parameter, with defined start and end points, and can be repeated cyclically.

The R&S SMBV100B supports two basic methods:

- **Sweep** mode

The instrument generates an RF signal which varies its frequency or level values in discrete steps between the start and end values. The values change according to a specific shape like sawtooth or triangle. The spacing is linear or logarithmic.

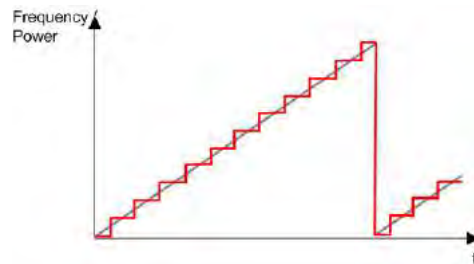

Figure 6-6: Schematic representation of a signal generated in sweep mode

The main application field of the "Sweep" mode is to determine the frequency response of a DUT.

- **List** mode

The instrument generates a varying output signal, based on a previously saved list with frequency, amplitude and step width values. While in sweep mode the frequency **or** the level values change, in list mode you can vary **both parameters simultaneously**. The frequency and level values do not need to have ascending or descending order, they can vary arbitrarily.

You can use a global dwell time, which means that the time interval is constant for all steps of the list, or different dwell times for each value pair.

Figure 6-7 represents the frequency and power value pairs, in this case with the dwell time set the same for all steps (global dwell time).

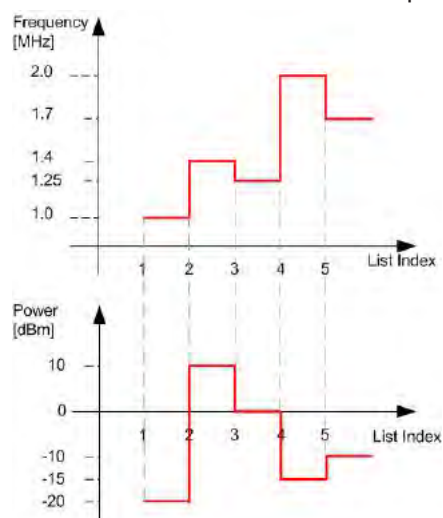

Figure 6-7: Schematic representation of a signal generated in list mode (global dwell time)

The list mode is especially useful in high-speed measurements with fast changing frequency and level settings.



Note that the shown diagrams represent the behaviour in theory. In real signal generation, the instruments usually have a blank time when the frequency or level changes.

Interactions and characteristics of list and sweep mode

- Activating the list mode automatically deactivates all RF and LF sweeps and vice versa.
- In list processing mode, the frequency and level display in the status bar is disabled.



- The sweep modes only work with a *global* dwell time, that means the time intervals are constant during signal generation.
- If you want to hold a running sweep at a specific frequency or level value, enter the value in the status bar. The sweep stops immediately.
- We recommend that you switch off the display update for optimum sweep performance, especially with short dwell times
See [Chapter 10.1.3, "Display Update Settings"](#), on page 483.

6.10.1 Signal Generation and Triggering in the Sweep and List Modes

In both operating modes "List" and "Sweep", triggering and signal generation follow the same principle. The instrument generates the signal continuously (that means triggered automatically) or in individual steps (controlled manually by an internal or external trigger signal).

The instrument expects the trigger signal at the Inst Trig connector.

The figures in this section give an overview on the signal generation in the sweep and list modes and the appropriate triggering. The figures show the signal state after activating the mode and the generation of the signal when a trigger event occurs. For each mode, the relevant parameters and settings are briefly explained.

Each "Sweep" and "List" mode dialog provides also a "Reset" function that sets the signal to the initial value or the beginning of the list. Depending on the selected trigger mode, the signal generation proceeds accordingly.



The naming of the selection parameters in manual control (GUI) sometimes deviates from the naming in the remote-control commands. In addition, the value names of the selection parameters used in the signal generator partly differ from the SCPI syntax. The instrument accepts all value names.

The correlation between the manual control and the corresponding remote control commands, including the SCPI conform syntax are explained for each mode (see the cross-reference tables).

See also the following programming examples on the sweep and list modes in remote control:

- [Example "Setup an RF frequency or power sweep"](#) on page 875
- [Example "Setup an LF sweep"](#) on page 829
- [Example "Create an RF list and activate the list mode"](#) on page 842

Auto mode (Sweep/List)

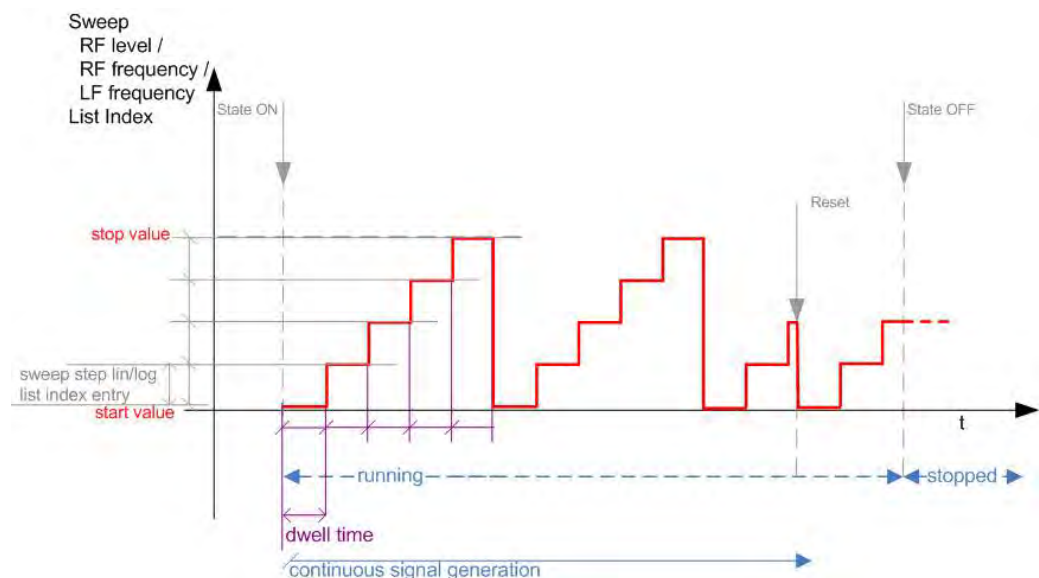

Figure 6-8: Auto mode (Sweep/List)

- The instrument generates the signal continuously.
- Trigger mode "Auto" is prerequisite (default). It causes the continuous generation of the sweep signal.
- Starts signal generation immediately with "State = On".
- Switches automatically to the next step when the **Dwell time** has elapsed.
- Stops signal generation with "State = Off".

Table 6-1: Cross-reference between manual and remote control in Auto mode (Sweep/List)

Manual control mode: "Auto"	Remote commands Rohde & Schwarz proprietary and [SCPI conform] value name
RF frequency sweep	:TRIGger<hw>:FSweep:SOURce AUTO [IMMediate] :SOURce<hw>:SWEep:FREQuency:MODE AUTO
RF level sweep	:TRIGger<hw>:PSweep:SOURce AUTO [IMMediate] :SOURce<hw>:SWEep:POWer:MODE AUTO
LF frequency sweep	:TRIGger<hw>:LFFSweep:SOURce AUTO [IMMediate] :SOURce<hw>:LFOutput<ch>:SWEep:FREQuency:MODE AUTO
List	:SOURce<hw>:LIST:MODE AUTO :SOURce<hw>:LIST:TRIGger:SOURce AUTO

Single / Extern Single mode (Sweep/List)

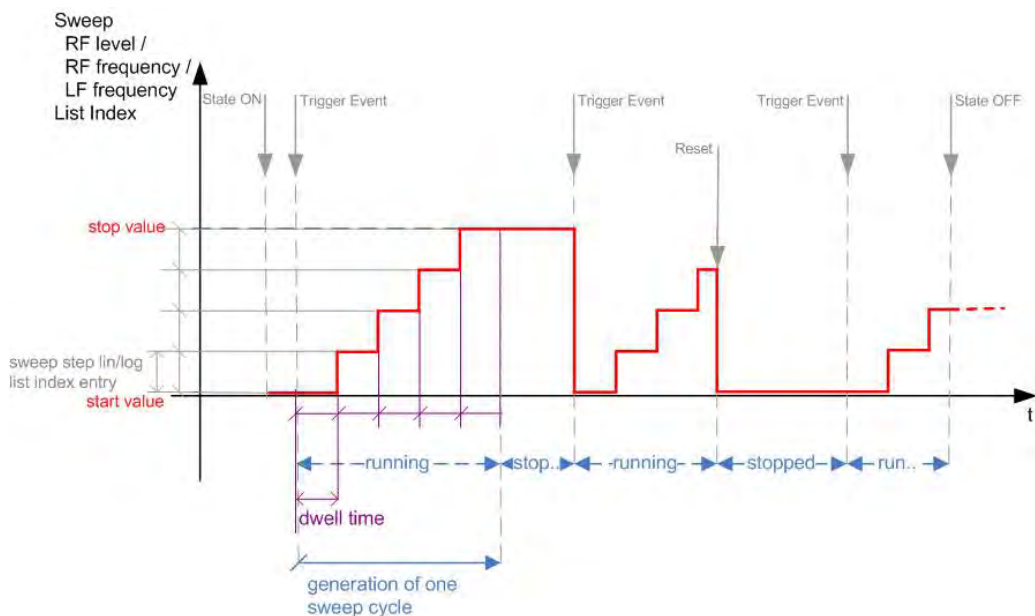

Figure 6-9: Single / Extern Single mode (sweep / list)



In single mode, you can specify, that the signal returns to the start value when a sweep cycle has been completed.

See "[The Retrace function](#)" on page 293 for details.

- The instrument generates a single sweep cycle.
- Trigger mode "Manual". A trigger event initiates one sweep from the start value to the end value.
- "State = On" sets the signal to the start value: the sweep start frequency, the sweep start power or the frequency-power value pair of the selected index in the list.
- Starts signal generation with a trigger event.

- Switches automatically to the next step when the **Dwell time** has elapsed.
- Stops signal generation at the set end value and waits for the subsequent trigger event.
- Trigger sources:
 - The "Execute Single Sweep" function.
 - The corresponding remote control command.
 - An externally applied trigger signal.
- "State = Off" stops the signal generation in sweep or list mode.

Table 6-2: Cross-reference between manual and remote control in Single / Extern Single modes (Sweep/List)

Manual control mode: "Single / Extern Single"	Remote commands Rohde & Schwarz proprietary and [SCPI conform] value name
RF frequency sweep	:TRIGger<hw>:FSweep:SOURce SINGLE [BUS] "Single" or :TRIGger<hw>:FSweep:SOURce EXTernal [EXTernal] "Extern Single" :SOURce<hw>:SWEep:FREQuency:MODE AUTO
RF level sweep	:TRIGger<hw>:PSweep:SOURce SINGLE [BUS] for "Single" or :TRIGger<hw>:PSweep:SOURce EXTernal [EXTernal] for "Extern Single" :SOURce<hw>:SWEep:POWer:MODE AUTO
LF frequency sweep	:TRIGger<hw>:LFFSweep:SOURce SINGLE [BUS] "Single" or :TRIGger<hw>:LFFSweep:SOURce EXTernal [EXTernal] "Extern Single" :SOURce<hw>:LFOutput<ch>:SWEep:FREQuency:MODE AUTO
List	:SOURce<hw>:LIST:TRIGger:SOURce SINGLE "Single" or :SOURce<hw>:LIST:TRIGger:SOURce EXTernal "Extern Single" :SOURce<hw>:LIST:MODE AUTO

Step / Extern Step mode (Sweep/List)

Figure 6-10: Step / Extern Step mode (sweep / list)

- The instrument generates the signal step-by-step.
- Starts signal generation with "State = On".
- Switches to the next step with a manual action.
If the end value is reached, signal generation starts again from the beginning.
- Stops signal generation with "State = Off".
- Trigger sources:
 - The rotary knob at the front panel.
 - The [Arrow] keys at the front panel.
 - The corresponding remote control commands.
 - An externally applied trigger signal.

To step through the sweep frequencies or levels:

- In manual mode:
 - Set the **Current Frequency** or **Current Level** values
 - Use the [Up] and [Down] keys or the rotary knob
- In remote control mode:
 - Use the commands `[:SOURce<hw>] :FREQuency:MANual` or `[:SOURce<hw>] :POWer:MANual` with the UP or DOWN parameter

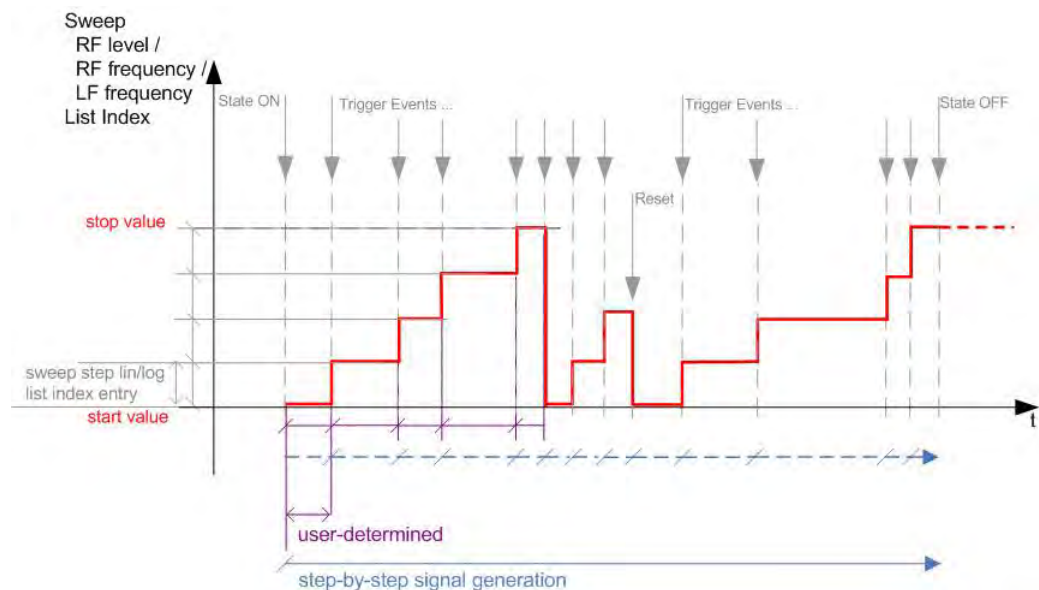

Steps that would exceed the sweep range are ignored.

Table 6-3: Cross-reference between manual and remote control in Step / Extern Step modes (Sweep/ List)

Manual control mode: "Step / Extern Step"	Remote commands Rohde & Schwarz proprietary and [SCPI conform] value name
RF frequency sweep	:TRIGger<hw>:FSWEEP:SOURce SINGLE [BUS] "Step" or :TRIGger<hw>:FSWEEP:SOURce EXTERNAL [EXTERNAL] for "Extern Step" :SOURce<hw>:SWEep:FREQuency:MODE STEP
RF level sweep	:TRIGger<hw>:PSWEEP:SOURce SINGLE [BUS] "Step" or :TRIGger<hw>:PSWEEP:SOURce EXTERNAL [EXTERNAL] "Extern Step" :SOURce<hw>:SWEep:POWer:MODE STEP
LF frequency sweep	:TRIGger<hw>:LFFSWEEP:SOURce SINGLE [BUS] "Step" or :TRIGger<hw>:LFFSWEEP:SOURce EXTERNAL [EXTERNAL] "Extern Step" :SOURce<hw>:LFOutput<ch>:SWEep:FREQuency:MODE STEP
List	:SOURce<hw>:LIST:TRIGger:SOURce SINGLE "Step" or :SOURce<hw>:LIST:TRIGger:SOURce EXTERNAL "Extern Step" :SOURce<hw>:LIST:MODE STEP

Extern Start/Stop mode (sweep)

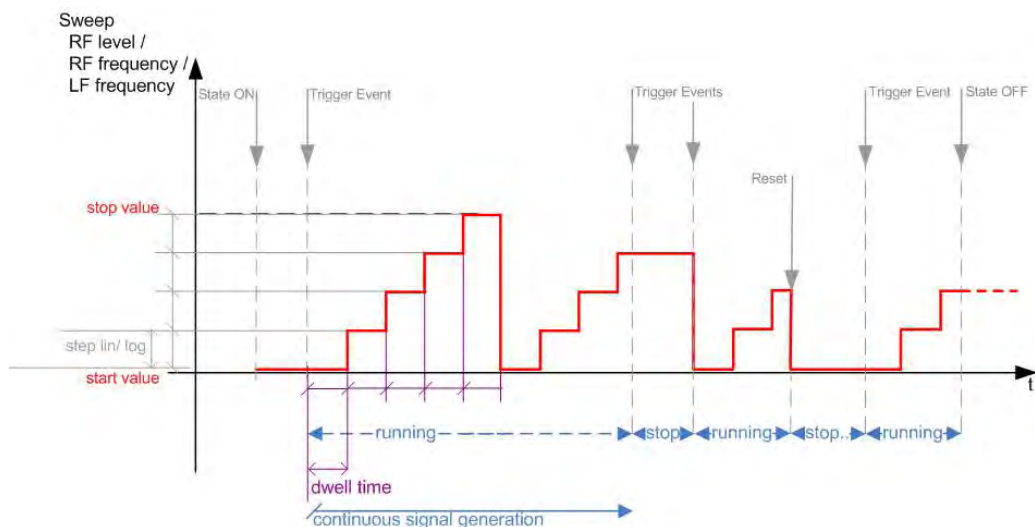

Figure 6-11: Extern Start/Stop mode (sweep)

- The instrument generates the signal continuously.
- Trigger mode "Auto" and "Sweep > State = On" are prerequisite.
- State "On" sets the signal to the start value, that is one of the following:
 - Sweep start frequency
 - Sweep start power
 - Frequency-power value pair of the selected index in the list
- Starts signal generation with a trigger event.

- Switches automatically to the next sweep step when the **Dwell time** has elapsed. If the end value is reached, signal generation continues with the next sweep cycle.
- Stops signal generation with the next external trigger event.
- Starts the signal generation again with the next trigger event, beginning at the start value.
- "State = Off" stops the signal generation in sweep or list mode.
- Trigger source: An externally applied trigger signal.

Table 6-4: Cross-reference between manual and remote control in Extern Start/Stop modes (sweep)

Manual control mode: "Extern Start/Stop"	Remote commands Rohde & Schwarz proprietary and [SCPI conform] value name
RF frequency sweep	:TRIGger<hw>:FSweep:SOURce EAUTO [-] :SOURce<hw>:SWEep:FREQuency:MODE AUTO
RF level sweep	:TRIGger<hw>:PSweep:SOURce EAUTO [-] :SOURce<hw>:SWEep:POWer:MODE AUTO
LF frequency sweep	:TRIGger<hw>:LFFSweep:SOURce EAUTO [-] :SOURce<hw>:LFOutput<ch>:SWEep:FREQuency:MODE AUTO

Manual mode (Sweep/List)



The **manual** mode only applies to remote control. It is not visible in the graphical user interface of the instrument and is described here for completeness.

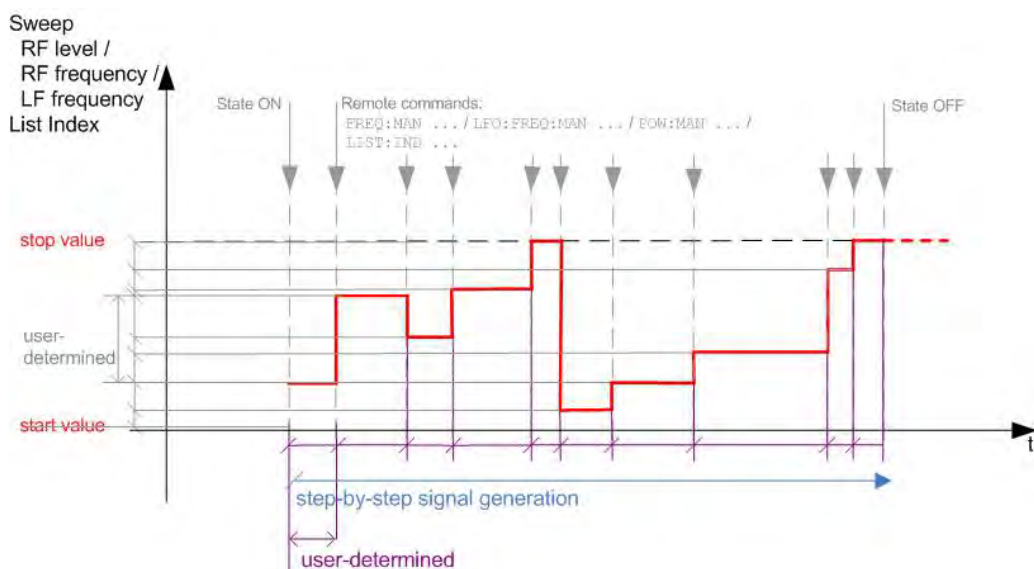

Figure 6-12: Manual mode in remote control (sweep / list)

- The instrument generates the signal in steps.
- Starts signal generation with "State = On".
- Switches to the next step with a user defined setting via remote control.

You can arbitrarily select a value within the range of the start and stop values by setting the frequency, power or index using the corresponding remote control command. There is no ascending or descending order.

- Stops signal generation with "State = Off".

Table 6-5: Remote control commands in manual mode (Sweep/List)

Remote control mode:	Remote commands
Manual	Rohde & Schwarz proprietary and [SCPI conform] value name
RF frequency sweep	:SOURce<hw>:FREQUency:MANUal <Manual>
RF level sweep	:SOURce<hw>:POWer:MANUal <Manual>
LF frequency sweep	:SOURce<hw>:LFOUtpuT:FREQUency:MANUal <Manual>
List	:SOURce<hw>:LIST:INDex <Index>

The Retrace function

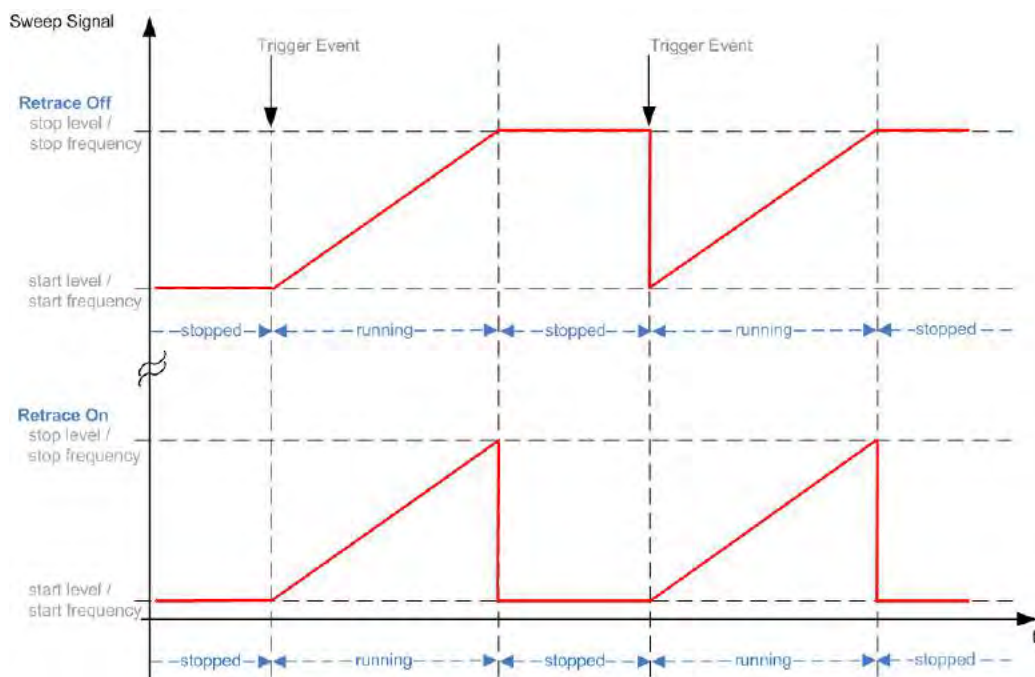

Retrace is a function especially designed for "Single" sweep modes, when the sweep signal follows a sawtooth shape. Working in this mode, the instrument performs a single sweep cycle when a trigger event occurs. The signal generation stops at the set end point (stop frequency or stop level), and waits for the next trigger event.

In this state, the upper value of the signal remains at the output until the next cycle starts. In particular, if you generate a level sweep signal, the high amplitude of the signal is output for a certain time. To protect the DUT from overload, the retrace function immediately resets the signal value to the start value at the end of a sweep cycle. It returns to the start level or start frequency until the next trigger is applied.

You can use the "Retrace" function if "Sweep > Mode = Single/External Single" and "Shape = Sawtooth", see:

- "Shape" on page 303
- "Mode" on page 302

6.10.2 About Sweep Mode

In sweep mode, the signal generator scans the sweep range gradually from one point to another, using a defined step size and following a triangle or sawtooth shape. This mode also enables you to change direction, that means, it is possible to step backwards.

See [Chapter 6.10.2.2, "Sweep Signal Shapes"](#), on page 296.

Configuration and operation of sweep mode signals

- The R&S SMBV100B generates a sweep signal by varying one of the following parameters: the *RF frequency*, the *LF frequency* or the *RF level*.
- In all sweep modes, you can perform a complete sweep cycle once, repeat the cycle continuously or step through it gradually.
- The instrument generates the sweep signal according to the sweep settings.
- The "Reset Sweep" function, provided in the sweep settings dialogs enables you to reset the sweep to its initial value and restart it.



Impact of changing the sweep mode during performance

If you change the sweep mode during the execution, the signal generator stops the sweep and starts with the next trigger event at the initial value.

6.10.2.1 Correlating Parameters in Sweep Mode

A sweep signal is a periodic signal that changes its frequency or level from a starting value to an ending value in a defined time.

The R&S SMBV100B provides various possibilities to configure a sweep signal. For example, you can determine the sweep range by the start and end values, or based on the start value and span. In any case, related parameters are adjusted accordingly.

The formulas below show how the sweep parameters correlate and the corresponding calculation basis, by the frequency and offset settings. Apart from "Center Frequency", "Span" and "Step_lin", the values apply accordingly to the level settings.

Table 6-6: Variables that are used in the following formulas

Variable	Description
Sweep range	Defined frequency or level value range
f_{CENTer}	Defined center frequency
f_{SPAN}	Defined extend of the sweep range

Variable	Description
f_{OFFSet}	Frequency offset
f_{START}	Start frequency of the sweep range
f_{STOP}	End frequency of the sweep range
f_1	Current sweep frequency
f_2	Next, subsequent sweep frequency
step_lin	Step size in linear scaling
step_log	Step size in logarithmic scaling
POINTS	Number of steps within the sweep range

Sweep range

The sweep range is defined by a start and an end value. How the remaining parameters correlate is shown below.

Offset = 0

Sweep Range = f_{START} to f_{STOP}

$$f_{\text{CENTer}} = (f_{\text{START}} + f_{\text{STOP}})/2$$

$$f_{\text{SPAN}} = (f_{\text{STOP}} - f_{\text{START}})$$

Where:

$$f_{\text{START}} = f_{\text{CENTer}} - (f_{\text{SPAN}}/2)$$

$$f_{\text{STOP}} = f_{\text{CENTer}} + (f_{\text{SPAN}}/2)$$

Offset≠0

A defined offset also affects the sweep range and the center frequency. Therefore, the set frequencies are only absolute values, if the Offset = 0. Offset ≠ 0 shifts the frequencies with the offset value:

Sweep Range = $f_{\text{START}} + f_{\text{OFFSet}}$ to $f_{\text{STOP}} + f_{\text{OFFSet}}$

$$f_{\text{CENTer}} = f_{\text{CENTer}} + f_{\text{OFFSet}}$$

$$f_{\text{SPAN}} = f_{\text{SPAN}} + f_{\text{OFFSet}}$$

The value range of the instrument is calculated as follows:

$$RF_{\text{min}} + f_{\text{OFFSet}} \text{ to } RF_{\text{max}} + f_{\text{OFFSet}}$$



It is possible to set $f_{\text{START}} > f_{\text{STOP}}$ and $f_{\text{START}} < f_{\text{STOP}}$, so that even a negative value is permitted for the "Span".

If you change the start and/or stop frequency, the span and center frequency change accordingly, and vice versa.

Sweep steps

In the following, you see how the sweep steps are calculated depending on the defined spacing mode. The formulas show a frequency sweep, but apply to the level settings in the same way.

The step size is added to the current value, to get the subsequent sweep step.

With **linear** scaling, the next frequency is calculated according to:

$$f_2 = f_1 + \text{step_lin}$$

In the **logarithmic** scaling, the step size is determined in per cent, as a constant fraction of the current frequency.

Successive frequencies are calculated as follows:

- For $f_{\text{START}} < f_{\text{STOP}}$
 $f_2 = f_1 * (1 + \text{step_log}/100)$
 If $f_2 > f_{\text{STOP}}$, then $f_2 = f_{\text{STOP}}$
- For $f_{\text{START}} > f_{\text{STOP}}$
 $f_2 = f_1 / (1 + \text{step_log}/100)$
 If $f_2 < f_{\text{STOP}}$, then $f_2 = f_{\text{STOP}}$

With "Shape = Triangle", the frequency values on the slope from f_{STOP} to f_{START} are the same as on the slope from f_{START} to f_{STOP} .

If you specify the number of steps within the sweep range, the step size is adjusted according to the following correlation:

- For **linear** sweeps and $f_{\text{START}} < f_{\text{STOP}}$
 $\text{POINTS}_{\text{frequency}} = ((f_{\text{START}} - f_{\text{STOP}})/\text{step_lin}) + 1 = (f_{\text{SPAN}}/\text{step_lin}) + 1$
- For **logarithmic** sweeps and $f_{\text{START}} < f_{\text{STOP}}$
 $\text{POINTS}_{\text{frequency}} = ((\log f_{\text{STOP}} - \log f_{\text{START}})/\log \text{step_log}) + 1$

If step_log changes, the value of POINTS is adjusted. The f_{START} and f_{STOP} values are retained.

6.10.2.2 Sweep Signal Shapes

The R&S SMBV100B supports the following sweep shapes:

- Sawtooth
 The sweep sequence resembles a sawtooth. One sweep runs from start to stop frequency, or level value respectively. Each subsequent sweep starts again at the start value.

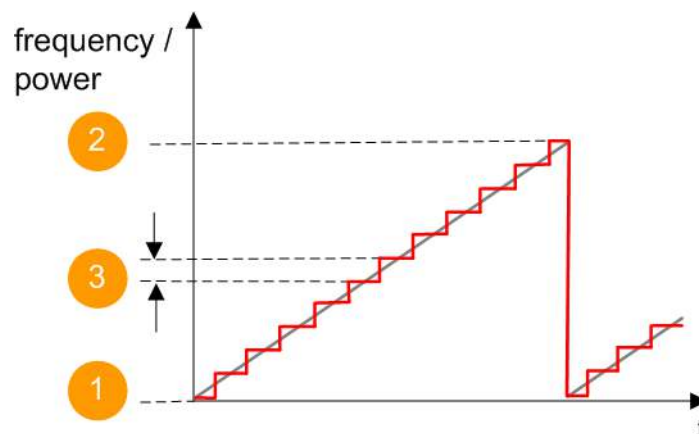

Figure 6-13: Sweep signal sawtooth shape

1 = Start value
2 = Stop value
3 = Step size

- Triangle
The sweep sequence resembles a triangle. One sweep runs from start to stop value frequency and back. Each subsequent sweep starts at the start value.

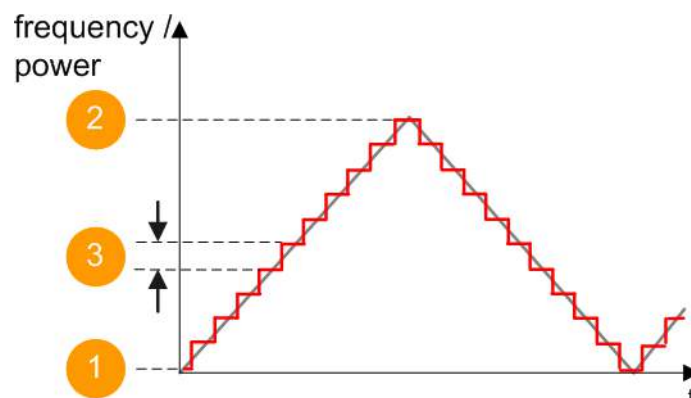

Figure 6-14: Sweep signal triangle shape

1 = Start value
2 = Stop value
3 = Step size

The current frequency or level of an RF frequency, level or LF frequency sweep is determined by the shape (e.g. sawtooth or triangle) and the spacing (linear or logarithmic), and the step size.

6.10.3 About List Mode

The list mode is used to generate the RF signal based on a set of predefined frequency and amplitude value pairs, with individual step times. You can define the values arbitrarily, in any order and varying step sizes, within the entire configurable value range of the instrument.

Configuration and operation of list mode signals

The parameters configuring the RF signal are defined in a list (table) and stored in a file.

Creating and handling lists

List files can be created in the following ways:

- **Internally**

Use the build-in table editor with columns for the frequency-level values pairs and the dwell time.

Define the values manually (row by row) or automatically, based on value range and step size.

(See [Chapter 6.10.7, "List Editor"](#), on page 314)

Lists are saved as files with user-definable filename and the predefined file extension *.lsw. To load a saved file, use the "File Manager".

(See [Chapter 9.8, "Using the File Manager"](#), on page 462)

- Lists can be exported, too. For example, to exchange configuration between instruments or to modify the file content with an external program and reload them again.

- **Externally**

Create a list file as a CSV file with Microsoft Excel, with a Notepad or a similar tool and save it with the predefined extension. Transfer the file to and load it into the instrument.

Dwell time mode

You can choose whether you want to use different dwell times or a fixed value for all steps in the list mode:

- "From List"

This mode uses the values from the data table.

See [Edit List Mode Data](#)

- "Global"

This mode processes the list with a fixed time interval you can set with [Global Dwell Time](#).

List processing mode

See:

- ["Live list processing mode"](#) on page 299

6.10.4 Significant Parameters and Functions

This section provides some basic parameters, settings and functions that affect the operating modes CW, list and sweep, that means at all frequency and level transitions of the RF signal.

Dwell time

Dwell time is the length of time that elapses from the beginning until the end of a step in list or sweep mode.

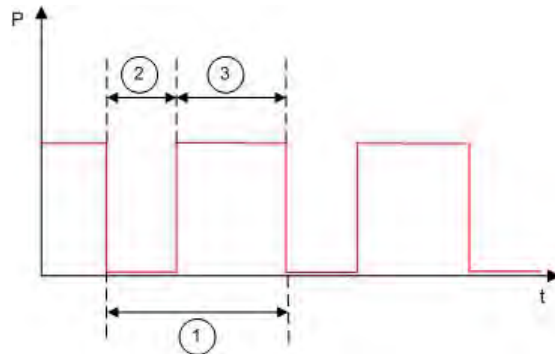

Figure 6-15: Dwell Time vs. settling time

- 1 = "Dwell Time" (as set with the parameter)
- 2 = Settling time
- 3 = Dwell time (effective)

However, the time the instrument requires for the signal to settle reduces the set dwell time:

$$t_{\text{dwell(effective)}} = t_{\text{dwell}} - t_{\text{settling}}$$

Hardware adjustments

The first time a list (new or modified) is processed, the instrument automatically calculates the necessary hardware settings. It can be performed during list processing, but delays the first cycle, especially with short dwell times.

With long dwell times, you can perform this calculation while the list is being processed; the entered dwell times are observed. With short dwell times, calculation of the hardware settings increases the dwell time for the initial processing cycle; the entered value is only observed from the second processing cycle onwards. In this case, a message indicates that there is a deviation between the current and set dwell times. After the first cycle, you do not need to perform additional calculations. The current dwell times do not deviate from the set dwell times.

Blanking

The instrument applies *blanking*, which temporarily turns off the RF signal when the frequency or level changes, until the signal has settled to a stable state.

Temporary blanking applies to all operating modes.

Live list processing mode

The R&S SMBV100B generates the signal directly from the value pairs in the database, and adjusts the hardware settings accordingly. The current instrument state and thus any change during the signal generation directly affects the RF signal. The temporary memory is not used.

You can conveniently modify parameters like modulation settings during run-time. Learning list mode data is not required. Impacts like temperature drift are also considered immediately.

This mode is optimized for **maximum signal quality**, and is useful if dwell times higher than 2 ms are sufficient.

6.10.5 Sweep Mode Settings

This section lists the settings of **all** available sweep modes.

Access:

1. Select "RF" > "Sweep/List" > "Frequency Sweep"
2. Select "RF" > "Sweep/List" > "Level Sweep"
3. Select "RF" > "Sweep/List" > "LF Frequency Sweep"

The sweep modes use the similar parameters to be configured. Thus, the description comprises the settings of the three dialogs, "RF Freq Sweep", "RF Level Sweep" and "LF Freq Sweep". If parameters relate to only particular modes, they are pointed out.

The remote commands required to define these settings are described in:

- [Chapter 12.16.6, "SOURce:FREQuency Subsystem"](#), on page 812
- [Chapter 12.16.17, "SOURce:SWEep Subsystem"](#), on page 874
- [Chapter 12.16.10, "SOURce:LFOutput Subsystem"](#), on page 829

Settings

- [General Sweep Settings](#)..... 300
- [Frequency Range Settings](#).....305
- [Level Range Settings](#)..... 307

6.10.5.1 General Sweep Settings

Access:

- ▶ Select, for example, "RF" > "Sweep/List" > "Frequency Sweep".

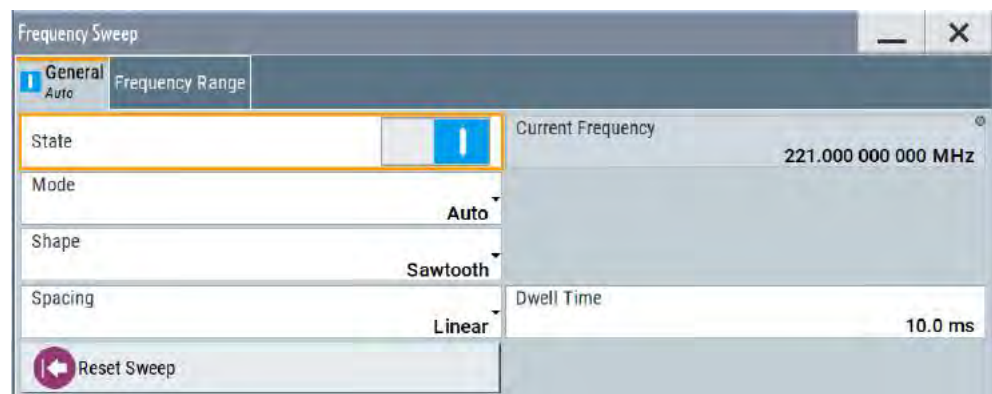

Settings

State (RF frequency sweep).....	301
State (RF level sweep).....	301
State (LF frequency sweep).....	301
Current Frequency.....	302
Current Level.....	302
Mode.....	302
Retrace.....	303
Shape.....	303
Spacing.....	304
Dwell Time	304
Trigger Slope.....	305
Execute Single Sweep	305
Show Connector.....	305
Reset Sweep	305

State (RF frequency sweep)

Activates RF frequency sweep signal generation.

Note: Active sweep mode deactivates other sweeps or lists and vice versa.

Remote command:

[:SOURce<hw>] :FREQuency:MODE on page 815

State (RF level sweep)

Activates RF level sweep signal generation.

Note: Active sweep mode deactivates other sweeps or lists and vice versa.

Remote command:

[:SOURce<hw>] :POWer:MODE on page 864

State (LF frequency sweep)

Status of the LF frequency sweep signal.

You find this parameter in two dialogs:

- "LF Frequency Sweep" turns on/off the signal generation. See [Sweep Mode Settings](#) for access.
- "Analog Modulation Sources" displays the current state (read-only). If it is turned on, this dialog provides the varying sweep frequency, see [Current Frequency](#).

Note: Active sweep mode deactivates other sweeps or lists and vice versa.

Remote command:

`[:SOURce<hw>] :LFOutput :FREQuency :MODE` on page 833

Current Frequency

In "RF/LF Frequency Sweep" mode, displays the current frequency.

In **Mode** = "Step", the parameter is editable and you can enter the next frequency step.

Remote command:

`[:SOURce<hw>] :FREQuency :MANual` on page 817

`[:SOURce<hw>] :LFOutput :FREQuency :MANual` on page 833

Current Level

Applies to "RF Level Sweep" mode.

Displays the current level value.

In **Mode** = "Step", the parameter is editable and you can enter the next level step.

Remote command:

`[:SOURce<hw>] :POWer :MANual` on page 864

Mode

Selects the sweep mode.

For detailed information on the sweep modes and the triggering, see [Chapter 6.10.1, "Signal Generation and Triggering in the Sweep and List Modes"](#), on page 286.

"Auto" Generates a continuously repeating sweep signal directly after activating the sweep mode.
The sweep steps are performed automatically, controlled by the dwell time.

"Single / Extern Single" Generates a single sweep cycle after a trigger event.
The sweep steps within the cycle are performed automatically, controlled by the dwell time. If one cycle is completed, the instrument waits for the next trigger event.

"Step / Extern Step" Generates the sweep signal step-by-step, manually triggered.

"Extern Start/Stop" Generates a continuously repeating sweep signal that is started, stopped, and restarted by subsequent external trigger events.
The sweep steps are performed automatically, controlled by the dwell time.

Remote command:

`[:SOURce<hw>] :SWEep [:FREQuency] :MODE` on page 878

`[:SOURce<hw>] :SWEep :POWer :MODE` on page 877

`[:SOURce<hw>] :LFOutput :SWEep [:FREQuency] :MODE` on page 840

`:TRIGger<hw> [:SWEep] :SOURce` on page 915

`:TRIGger<hw> :FSWep :SOURce` on page 915

`:TRIGger<hw> :PSWep :SOURce` on page 915

`:TRIGger<hw> :LFFSweep :SOURce` on page 915

Retrace

For "Shape = Sawtooth" and "Mode = Single/External Single", enables changing the signal to the start value while it is waiting for the next trigger event. It returns to the start level or start frequency until the next trigger is applied.

Remote command:

`[:SOURce<hw>] :SWEep [:FREQuency] :RETRace` on page 881

`[:SOURce<hw>] :SWEep:POWEr:RETRace` on page 881

`[:SOURce<hw>] :LFOuTput:SWEep [:FREQuency] :RETRace` on page 840

Shape

Selects the waveform shape of the sweep signal.

"Sawtooth" The sweep runs from start to stop frequency. The subsequent sweep starts at the start value, i.e. the shape of the sweep sequence resembles a sawtooth.

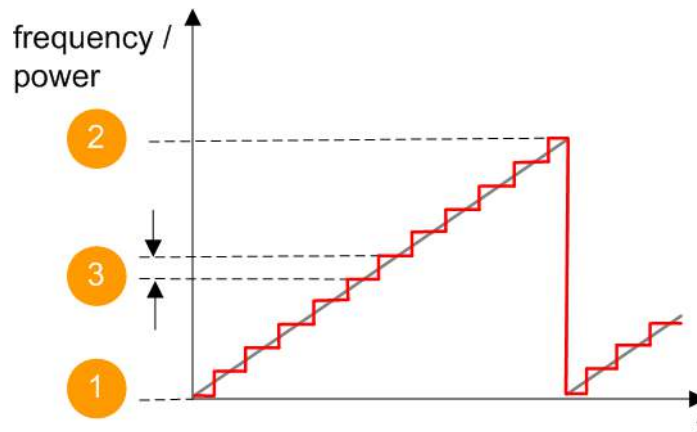

Figure 6-16: Sweep signal sawtooth shape

1 = Start value

2 = Stop value

3 = Step width

"Triangle"

The sweep runs from start to stop value and back, i.e. the shape of the sweep resembles a triangle. Each subsequent sweep starts at the start frequency.

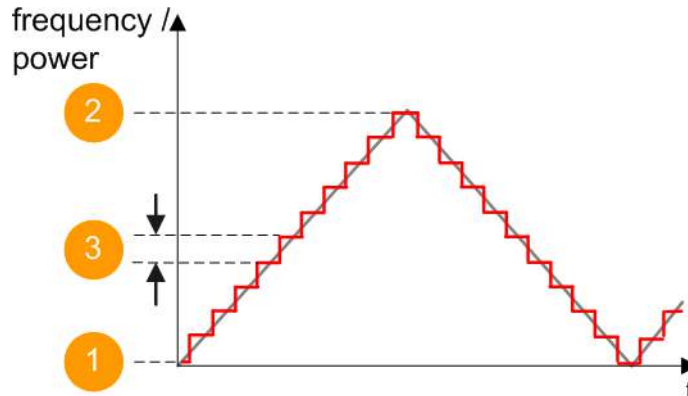

Figure 6-17: Sweep signal triangle shape

- 1 = Start value
- 2 = Stop value
- 3 = Step width

Remote command:

`[:SOURce<hw>] :SWEep [:FREQuency] :SHAPE` on page 880

`[:SOURce<hw>] :SWEep :POWER :SHAPE` on page 880

`[:SOURce<hw>] :LFOutput :SWEep [:FREQuency] :SHAPE` on page 841

Spacing

In "RF and LF Frequency Sweep" modes, selects the mode for the calculation of the frequency intervals, with which the current frequency at each step is increased or decreased.

Enter the step size with the parameter [Step Linear/Step Logarithmic](#) .

- "Linear" Takes the frequency value entered as absolute value in Hz.
- "Logarithmic" Takes the value entered as a logarithmic value, i.e. as a constant fraction of the current frequency in %.

Remote command:

`[:SOURce<hw>] :SWEep [:FREQuency] :SPACing` on page 879

`[:SOURce<hw>] :LFOutput :SWEep [:FREQuency] :SPACing` on page 841

Dwell Time

Defines the duration of the individual sweep steps.

See also [Chapter 6.10.4, "Significant Parameters and Functions"](#), on page 298.

Remote command:

`[:SOURce<hw>] :SWEep [:FREQuency] :DWELl` on page 878

`[:SOURce<hw>] :SWEep :POWER :DWELl` on page 877

`[:SOURce<hw>] :LFOutput :SWEep [:FREQuency] :DWELl` on page 839

Trigger Slope

For "Mode = Extern Step/Single", selects the polarity of the active slope of an applied instrument trigger.

Trigger signal is expected at the Inst Trig connector.

"Positive" The rising edge of the trigger signal triggers the instrument.

"Negative" The falling edge of the trigger signal triggers the instrument.

Remote command:

[\[:SOURce\]:INPut:TRIGger:SLOPe](#) on page 822

Execute Single Sweep

In "Mode = Single", starts a sweep manually.

Remote command:

[\[:SOURce<hw>\]:SWEep\[:FREQuency\]:EXECute](#) on page 880

[\[:SOURce<hw>\]:SWEep:POWer:EXECute](#) on page 880

[\[:SOURce<hw>\]:LFOutput:SWEep\[:FREQuency\]:EXECute](#) on page 839

[:TRIGger<hw>\[:SWEep\]\[:IMMediate\]](#) on page 917

[:TRIGger<hw>:FSWep\[:IMMediate\]](#) on page 917

[:TRIGger<hw>:PSWep\[:IMMediate\]](#) on page 917

[:TRIGger<hw>:LFFSweep:IMMediate](#) on page 917

**Show Connector**

Accesses a dialog that displays the physical location of the selected connector on the front/rear panel of the instrument.

Reset Sweep

Resets a sweep.

With the next trigger event, the sweep starts at the initial value.

Remote command:

[\[:SOURce<hw>\]:SWEep:RESet\[:ALL\]](#) on page 882

6.10.5.2 Frequency Range Settings

Access:

1. Select for example "RF" > "Sweep/List" > "Frequency Sweep"
2. Select "Frequency Range".

Frequency Sweep	
General Auto	Frequency Range
Start Frequency	100.000 000 000 MHz
Stop Frequency	500.000 000 000 MHz
Center Frequency	300.000 000 000 MHz
Span	400.000 000 000 MHz
Spacing	Linear
Step Linear	1.000 000 000 MHz

Settings

Start Frequency/Stop Frequency	306
Center Frequency	306
Span.....	306
Spacing.....	306
Step Linear/Step Logarithmic	307

Start Frequency/Stop Frequency

Defines the frequency sweep range by setting the start and end values.

See [Chapter 6.10.2.1, "Correlating Parameters in Sweep Mode"](#), on page 294.

Remote command:

[:SOURce<hw>] :FREQuency:START on page 819

[:SOURce<hw>] :FREQuency:STOP on page 820

[:SOURce<hw>] :LFOutput:FREQuency:START on page 834

[:SOURce<hw>] :LFOutput:FREQuency:STOP on page 834

Center Frequency

In "RF Frequency Sweep" mode, sets the RF center frequency.

See [Chapter 6.10.2.1, "Correlating Parameters in Sweep Mode"](#), on page 294.

Remote command:

[:SOURce<hw>] :FREQuency:CENTer on page 819

Span

In "RF Frequency Sweep" mode, sets the span of the frequency sweep range.

See [Chapter 6.10.2.1, "Correlating Parameters in Sweep Mode"](#), on page 294.

Remote command:

[:SOURce<hw>] :FREQuency:SPAN on page 819

Spacing

In "RF and LF Frequency Sweep" modes, selects the mode for the calculation of the frequency intervals, with which the current frequency at each step is increased or decreased.

Enter the step size with the parameter [Step Linear/Step Logarithmic](#) .

"Linear" Takes the frequency value entered as absolute value in Hz.

"Logarithmic" Takes the value entered as a logarithmic value, i.e. as a constant fraction of the current frequency in %.

Remote command:

`[:SOURce<hw>] :SWEep [:FREQuency] :SPACing` on page 879

`[:SOURce<hw>] :LFOutput :SWEep [:FREQuency] :SPACing` on page 841

Step Linear/Step Logarithmic

In "RF/LF Frequency Sweep" mode, sets the step width for the individual frequency sweep steps. The value is added at each sweep step to the current frequency.

Depending on the current [Spacing](#), you can enter either an absolute or logarithmic step width.

See [Chapter 6.10.2.1, "Correlating Parameters in Sweep Mode"](#), on page 294.

"Step Linear" The step width is a constant value in Hz.

"Step Logarithmic"

The step width is determined logarithmically in %, i.e. as a constant fraction of the current frequency.

Remote command:

`[:SOURce<hw>] :SWEep [:FREQuency] :STEP [:LINear]` on page 881

`[:SOURce<hw>] :SWEep [:FREQuency] :STEP :LOGarithmic` on page 881

`[:SOURce<hw>] :LFOutput :SWEep [:FREQuency] :STEP [:LINear]` on page 842

`[:SOURce<hw>] :LFOutput :SWEep [:FREQuency] :STEP :LOGarithmic`

on page 841

6.10.5.3 Level Range Settings

Access:

1. Select "RF" > "Sweep/List" > "Level Sweep"
2. Select "Level Range".

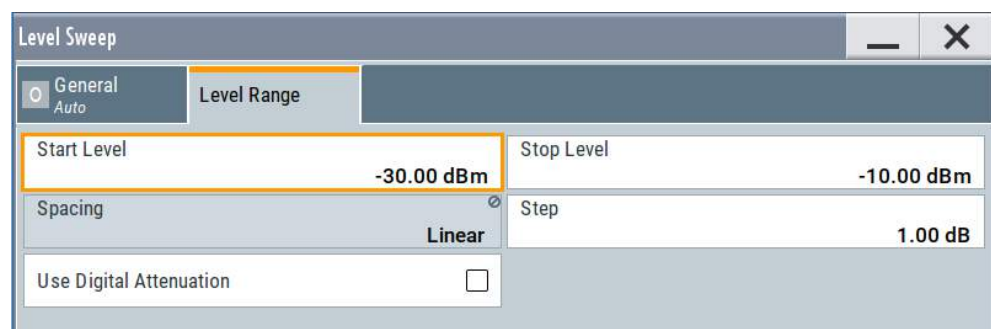

Settings

Start Level / Stop Level	308
Spacing	308
Step	308
Use Digital Attenuation	308

Start Level / Stop Level

Defines the level sweep range by setting the start and end values.

See [Chapter 6.10.2.1, "Correlating Parameters in Sweep Mode"](#), on page 294.

Remote command:

`[:SOURce<hw>] :POWer:STARt` on page 866

`[:SOURce<hw>] :POWer:STOP` on page 866

Spacing

Indicates that the level step intervals are linearly (straight proportional) distributed, i.e. intervals are of equal size.

Set the step size with the parameter "Step".

Remote command:

n.a.

Step

Applies to "RF Level Sweep" mode.

Sets the step width for the level sweep steps logarithmically in dB.

Remote command:

`[:SOURce<hw>] :SWEep:POWer:STEP [:LOGarithmic]` on page 878

Use Digital Attenuation

Activates digital attenuation during RF level sweep.

6.10.6 List Mode Settings

The "List Mode" dialog contains all the functions and settings for creating and handling lists with RF frequency/level pairs for generating the RF signal based on these values.

Access:

- ▶ Select "RF" > "Sweep/List" > "List mode".

The dialog contains parameters for configuring the list mode processing, entering list mode data and transferring data files from or to the instrument.

The remote commands required to define these settings are described in [Chapter 12.16.11, "SOURce:LIST Subsystem"](#), on page 842.

- [General Settings](#)..... 308
- [List Mode Data Settings](#)..... 311
- [Import/Export Settings](#).....312

6.10.6.1 General Settings

Access:

- ▶ Select "RF" > "Sweep/List" > "List mode > General".

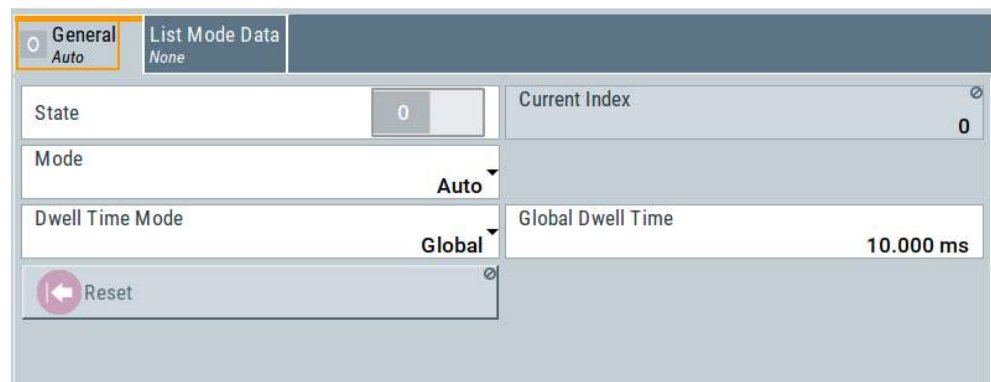

In the "General" tab, you can configure the trigger and dwell time modes for list processing and activate signal generation.

Settings

State	309
Current Index	309
Mode.....	309
Dwell Time Mode.....	310
Global Dwell Time.....	310
Trigger Slope.....	310
Show Connector.....	310
Reset	310
Execute Single.....	311

State

Activates the list mode and processes the currently selected list.

Note: Active sweep mode deactivates other sweeps or lists and vice versa.

Remote command:

[:SOURce<hw>] :FREQuency:MODE on page 815

Current Index

Sets the list index for list processing in "Step" mode. In the other modes, the index indicates the current step.

Remote command:

[:SOURce<hw>] :LIST:INDEX on page 847

Mode

Selects the mode for list processing.

For detailed information on the sweep modes and the triggering, see [Chapter 6.10.1, "Signal Generation and Triggering in the Sweep and List Modes"](#), on page 286.

"Auto" Generates the signal by processing the frequency/level value pairs of the list from the beginning to the end.
The list steps are performed automatically, controlled by the dwell time. If you switch from any mode to "Auto", signal generation always starts at the top of the list.

"Single / Extern Single"

Generates the signal by processing the frequency/level value pairs of the list once from the beginning to the end after a trigger event.

The list steps are performed automatically, controlled by the dwell time. If one cycle is completed, the instrument waits for the next trigger event.

"Step / Extern Step"

Generates the signal by processing the frequency/level value pairs of the list step-by-step, manually triggered.

Remote command:

`[:SOURce<hw>] :LIST:TRIGger:SOURce` on page 850

`[:SOURce<hw>] :LIST:MODE` on page 848

Dwell Time Mode

Selects either variable dwell times or a fixed dwell time to perform signal generation in list mode.

"Global" Uses the same dwell time for all lists steps, set with [Global Dwell Time](#).

"From List" Uses the dwell times from the list.
You can define the dwell time for each frequency/level value pair individually, see [Chapter 6.10.7, "List Editor"](#), on page 314.

Remote command:

`[:SOURce<hw>] :LIST:DWELL:MODE` on page 846

Global Dwell Time

Sets the dwell time for [Dwell Time Mode](#) > "Global".

See also ["Dwell time"](#) on page 299.

Remote command:

`[:SOURce<hw>] :LIST:DWELL` on page 845

Trigger Slope

For "Mode = Extern Step/Single", selects the polarity of the active slope of an applied instrument trigger.

Trigger signal is expected at the Inst Trig connector.

"Positive" The rising edge of the trigger signal triggers the instrument.

"Negative" The falling edge of the trigger signal triggers the instrument.

Remote command:

`[:SOURce] :INPut:TRIGger:SLOPe` on page 822

**Show Connector**

Accesses a dialog that displays the physical location of the selected connector on the front/rear panel of the instrument.

Reset

Resets the list to the starting point.

Remote command:

[:SOURce<hw>] :LIST:RESet on page 852

Execute Single

Manually starts list processing in "Single" mode.

Remote command:

[:SOURce<hw>] :LIST:TRIGger:EXECute on page 849

6.10.6.2 List Mode Data Settings

Access:

1. Select "RF" > "Sweep/List" > "List mode".
2. Select "List Mode Data".

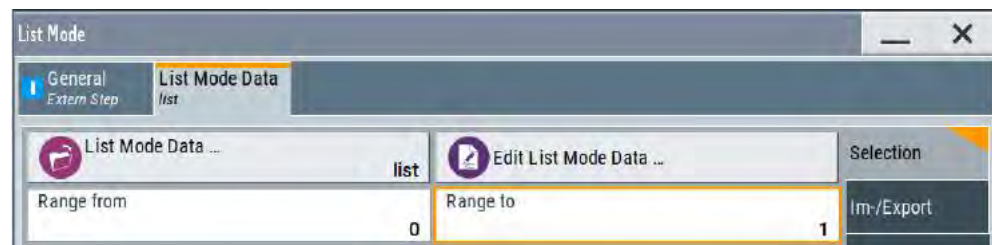

This dialog contains the parameters required for creating and editing lists, activating the learning function and selecting the list processing mode.

Settings

List Mode Data	311
Edit List Mode Data	311
List Range from/to	312

List Mode Data

Accesses the standard "Select List" dialog for selecting, creating and editing a list file. The currently loaded file is indicated.

You can create data lists with the internal editor or import externally created files, see "Creating and handling lists" on page 298.

Remote command:

[:SOURce<hw>] :LIST:CATalog? on page 851

[:SOURce<hw>] :LIST:SElect on page 852

[:SOURce<hw>] :LIST:DElete on page 851

[:SOURce<hw>] :LIST:DElete:ALL on page 851

Edit List Mode Data

Opens the editor to insert and save data lists with RF frequency, power and dwell time values, see Chapter 6.10.7, "List Editor", on page 314.

You find this function also in standard file select dialog, accessed via [List Mode Data](#) .

List Range from/to

Defines an index range in the current list by setting the start and stop index.

The instrument generates the signal with the values of the selected index range and ignores all other list entries.

Remote command:

[:SOURce<hw>] :LIST:INDEX:START on page 848

[:SOURce<hw>] :LIST:INDEX:STOP on page 848

6.10.6.3 Import/Export Settings

Access:

1. Select "RF" > "Sweep/List" > "List Mode".
2. Select "List Mode Data" > "Im-/Export".

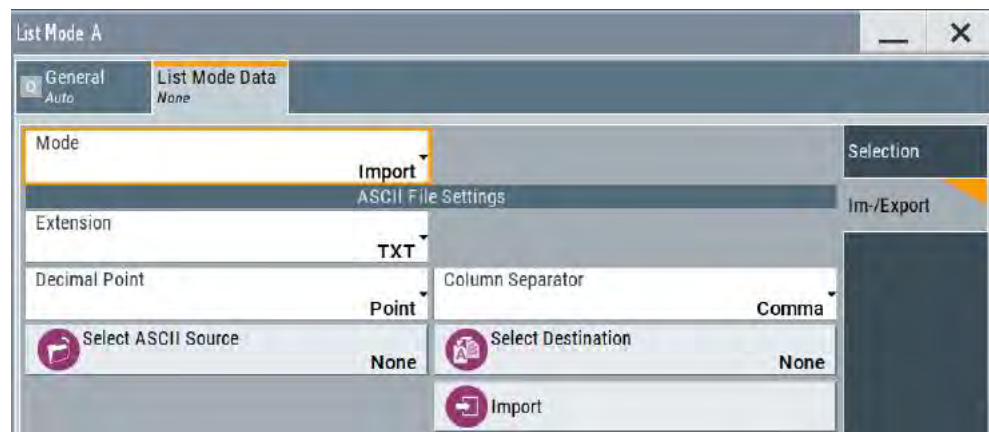

The "Im-/Export" dialog provides the parameters for importing or exporting files with user data in standard ASCII *.txt or *.csv file format.

The table separators and the decimal floating point numbers are customizable.

Settings

Mode	312
ASCII File Settings.....	313
Select (ASCII) Source/Select (ASCII) Destination.....	313
Select Source/Select ASCII Destination.....	313
Import / Export.....	313

Mode

Selects import or export of a data list file. The provided parameters vary according to the selected mode.

Remote command:

[:SOURce<hw>] :LIST:DEXChange:MODE on page 855

[:SOURce<hw>] :CORRection:DEXChange:MODE on page 810

ASCII File Settings

Defines the format and the separators of the associated data file.

- "Extension" Selects *.csv or *.txt format.
- "Decimal Point" Sets "Point" (dot) or "Comma" as the decimal separator used in the ASCII data with floating-point numerals.
- "Column Separator" Sets the separator between the columns in an ASCII table.
Available are: "Tab", "Semicolon", "Comma" or "Space".

Remote command:

- [\[:SOURCE<hw>\]:LIST:DEXChange:AFILe:EXTension](#) on page 854
- [\[:SOURCE<hw>\]:LIST:DEXChange:AFILe:SEParator:DECimal](#) on page 854
- [\[:SOURCE<hw>\]:LIST:DEXChange:AFILe:SEParator:COLumn](#) on page 854
- [\[:SOURCE<hw>\]:CORRection:DEXChange:AFILe:EXTension](#) on page 808
- [\[:SOURCE<hw>\]:CORRection:DEXChange:AFILe:SEParator:DECimal](#) on page 809
- [\[:SOURCE<hw>\]:CORRection:DEXChange:AFILe:SEParator:COLumn](#) on page 809

Select (ASCII) Source/Select (ASCII) Destination

In "Mode > Import", access the file select dialog that provides standard file handling functions.

Where:

- "Select ASCII Source": defines the file to be loaded (imported)
- "Select ASCII Destination": selects the filename under that the loaded file is saved

Remote command:

- [\[:SOURCE<hw>\]:LIST:DEXChange:AFILe:CATalog?](#) on page 853
- [\[:SOURCE<hw>\]:LIST:DEXChange:AFILe:SElect](#) on page 854
- [\[:SOURCE<hw>\]:CORRection:DEXChange:AFILe:CATalog?](#) on page 808
- [\[:SOURCE<hw>\]:CORRection:DEXChange:AFILe:SElect](#) on page 809

Select Source/Select ASCII Destination

In "Mode > Export", access the file select dialog that provides standard file handling functions.

Where:

- "Select Source": selects the file to be exported
- "Select ASCII Destination": defines the filename and the file path for the exported file

Remote command:

- [\[:SOURCE<hw>\]:LIST:DEXChange:SElect](#) on page 855
- [\[:SOURCE<hw>\]:CORRection:DEXChange:SElect](#) on page 810

Import / Export

Imports or exports the selected data list file, depending on the current mode.

Remote command:

- [\[:SOURCE<hw>\]:LIST:DEXChange:EXECute](#) on page 853
- [\[:SOURCE<hw>\]:CORRection:DEXChange:EXECute](#) on page 809

6.10.7 List Editor

The "User Correction" and "List Mode" dialogs provide a build-in list editor for defining the corresponding value pairs.

The table and navigation functions of the UCOR and list mode editors have the same structure and are therefore summarized below. The access is specified for both modes, the fields and functions are explained using the example of the list mode.

Access to "Edit List Mode Data":

- ▶ "RF" > "Sweep/List" > "List Mode" > "List Mode Data" > "Edit List Mode Data"

	Frequency /Hz	Correction Value /dB
0	1 560 000 000.00	11.51
1	1 561 000 000.00	11.03
2	1 562 000 000.00	10.55
3	1 563 000 000.00	10.07
4	1 564 000 000.00	9.59
5	1 565 000 000.00	9.11
6	1 566 000 000.00	8.63
7	1 567 000 000.00	8.15
8	1 568 000 000.00	7.67
9	1 569 000 000.00	7.19
10	1 570 000 000.00	6.71
11	1 571 000 000.00	6.23

Go To
Edit
Fill with Sensor ...
Save As ...
Save

The editor for list mode data provides a table with RF frequency and power values and standard navigation functions.

Access to "Edit User Correction Data":

- ▶ "RF" > "RF Level" > "User Correction" > "Edit User Cor. Data"

	Frequency /Hz	Power /dBm	Dwell Time /s
0	1 000 000 000.000	-20.00	0.010 000
1	1 500 000 000.000	-25.00	0.010 000
2	3 000 000.000	-10.00	0.050 000
3	2 000 000 000.000	-30.00	0.100 000
4			

Go To Edit Save As ... Save

The editor for user correction provides a table with RF frequency and power values, an extra column for defining variable dwell times, and standard navigation functions.



All columns in a row must contain values. Cells with missing values are therefore filled automatically, using the value of the previous row.

If you use **global dwell time in list mode**, consider also that the instrument uses the value set with [Global Dwell Time](#) for all list steps and not the values from the list.

Since the table and navigation functions can be assumed to be known, the following description contains a brief overview, shown by the example of the "List Data Editor". If a function relates to a particular dialog, it is explicitly stated.

Settings

Edit List Mode Data.....	315
Data handling keys	316
L Go To.....	316
L Edit.....	316
L Fill with Sensor.....	316
L Save As/Save.....	316
Fill.....	316

Edit List Mode Data

Table with values for list or user correction processing.

Note: Once you enter a value, the editor automatically adds preset values in the other columns. This functionality protects against data loss, otherwise incomplete rows will be lost when saving. You can simply override these values.

"Frequency /Hz"

Sets the frequency values.

Remote command:

[:SOURce<hw>] :LIST:FREQuency on page 847

[:SOURce<hw>] :CORRection:CSET:DATA:FREQuency on page 805

"Power /dBm" Sets the level values.

Remote command:

[:SOURce<hw>] :LIST:POWer on page 848

[:SOURce<hw>] :CORRection:CSET:DATA:POWer on page 805

"Dwell /s" In list mode, sets the dwell time values.

Remote command:

[:SOURce<hw>] :LIST:DWELL:LIST on page 846

Data handling keys

Standard functions for file and data handling.

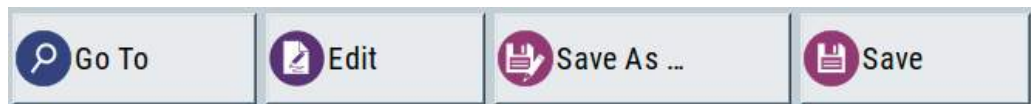

Go To ← Data handling keys

Selects a row for editing.

Edit ← Data handling keys

Enables you to insert, or delete a row or ranges within a list, and provides access to a dialog for automatic filling, see " Fill... " on page 316.

Fill with Sensor ← Data handling keys

Opens a dialog to configure the automatic filling of user correction data with an R&S NRP power sensor. Available in UCOR mode only.

See [Chapter 6.12.3.3, "Fill with Sensor"](#), on page 360

Save As/Save ← Data handling keys

Stores the list in a file with user-defined name and predefined file extension. To save a copy or create a file, use the "Save as" function.

Fill...

Provides parameters for filling a table automatically with user-defined values.

From 0	Range 1
Column To Fill Frequency/Hz	
Start Value 2.000 000 000 000 GHz	End Value 2.000 000 000 000 GHz
Increment Value 200.000 000 000 MHz	
<input checked="" type="checkbox"/> Fill	

To fill the table, select "Fill".

Note: Once you enter a value or fill a column, the editor automatically adds preset values in the other columns. This functionality protects against data loss, otherwise incomplete rows will be lost when saving. You can simply override these values.

"From / Range"

Defines the start line and number of lines to be filled.

"Column To Fill"

Selects, if the column is filled up with frequencies in Hz, levels in dBm or dwell times in s.

"Start Value / End Value"

Sets the start value for frequency, level or dwell time. The end value is read only and depends on the increment value and the range.

"Increment Value"

Determines the step size.

"Fill"

Fills the column specified in "Column To fill".

6.10.8 How to Generate a Signal in List or Sweep Mode

This section shows you how to configure a varying RF output signal for both, the list and sweep modes.

To configure the frequency sweep signal

1. In the status bar, enter "Freq = 6 GHz" and "Lev = -25 dBm".
2. Select "RF" > "Sweep/List" > "RF Frequency Sweep"
3. Select "Mode > Auto".
4. Select "Spacing > Linear".
5. Set "Dwell Time > 15.0 ms".

6. In the "Frequency Range" tab, set "Start Freq > 200 MHz" and "Stop Freq > 600 MHz".
(Alternatively you can set "Center Freq > 400 MHz" and "Span > 400 MHz".)
7. Set the step width "Step Lin > 10 MHz" and "Dwell Time > 10.0 ms".
8. In the "Advanced" tab, trigger the sweep "Auto".
9. In the "General" tab, select "State > On".

Example: Fast changing frequency and level settings in list mode

The following example shows you how to generate an amplitude modulated RF signal based on list mode data.

General workflow

Since any change of the hardware settings or list entries can affect the RF signal characteristics directly, we recommend that you proceed as follows:

1. Configure the modulation settings.
Activate the RF signal.
2. Wait until the hardware settings have settled.
3. Create a list file.
4. Configure the list mode.
5. Activate list mode.

To configure amplitude modulation and switch RF on

1. Press [Preset] to start from an initial state.
2. Select "RF" > "Analog Modulation" > "Amplitude Modulation > On".
3. Select "RF > On" to activate RF signal generation.

To create list mode data

1. Select "RF" > "Sweep/List" > "List Mode".
2. In the "List Mode Data" tab, select "List Mode Data > New"
3. Enter the filename `ListMode_Test` for the data list and confirm with "Ok".
The instrument creates a file and stores it in the `/var/user/` directory.
4. Select "Edit List Mode Data".
5. Enter the first values "Frequency > 2", "Power > 0" and "Dwell > 2".
6. Enter further frequency, power and dwell time values in the same way.
7. Select "Save" and close the dialog.

To configure the list mode and start signal generation

1. In the "General" tab, select "List Mode > Auto".
2. Select "Dwell Time Mode > From List".
3. Switch state to "On".
4. Select "General > State > On".

The instrument continuously generates an amplitude-modulated RF signal whose frequency and level values change according to the dwell times, as defined in the list.

With active list mode, the generator displays no frequency and level values in the status bar, but you can check the following parameters.

- In the list mode dialog, the current index indicates the steps of the signal generation.
- In remote control mode, you can query:
 - The current state with `[:SOURCE<hw>] :LIST:RUNNING?`
 - Current parameters with the commands `FREQ?`, `POW?` and `LIST:DWEL?`.

6.11 Analog Modulations

The R&S SMBV100B supports AM (amplitude modulation), FM (frequency modulation), Φ M (phase modulation (PhiM)), and also PULM (pulse modulation). It generates low frequency signals (LF) as sine, triangle, trapezoidal or square (pulse) waveform, that can be output and further processed by a downstream instrument.

6.11.1 Required Options

R&S SMBV100B base unit equipped with the following options:

- Option pulse modulator (R&S SMBVB-K22)
- Option pulse generator (R&S SMBVB-K23)
(supports generation of single and double pulse signals)
- Option multi-function generator (R&S SMBVB-K24)
- Option AM/FM/PhiM, up to 6 GHz (R&S SMBVB-K720)
- Option frequency R&S SMBVB-B103

For more information, see data sheet.

6.11.2 Modulation Types and Signal Sources

Radio transmitters do not transmit an audio signal directly. Instead, they modulate the audio signal onto a continuous wave (CW) carrier with much higher frequency.

A CW carrier has a sinusoidal waveform with constant amplitude and constant frequency. Modulating a signal onto the carrier means varying a property of the carrier

according to the modulating signal. The three basic modulation types FM, AM and PhiM for example, vary one property of the carrier proportional to the instantaneous amplitude of the modulating signal.

Signal sources

If fully equipped, the R&S SMBV100B modulates signals from the following sources:

- **Internal modulation source**
 - *Two LF generators*
Each of the LF generators provides a modulation signal with sine, pulse, triangle or trapezoid shape.
 - *Noise generator*
The noise generator supplies white noise with selectable bandwidth and distribution.
 - *High-performance pulse generator*
Generates single or double pulse signals.
- **External modulation source**
 - Amplitude, frequency or phase modulation signals are input at the Mod Ext connector.
 - Pulse modulation signals, at the Pulse Ext connector.

Signal output

You can perform AM, FM and PhiM with the signal of any of the provided sources. Moreover, you can combine two modulation signals and generate a two-tone signal. Regardless of the signal source, the generated signal can be output for further processing in a downstream instrument.

Current configuration is indicated in the "Analog Modulations > Overview" dialog; the output signal routing can be changed, too.

Input and output connectors

Direction	Modulation	Connector	Required option
Output	Pulse modulation from internal signal Loop through of pulse signal from Pulse Ext	Pulse Video	R&S SMBVB-K22/-K23
	All analog modulations Marks the valid level and frequency	Signal Valid	
	LF generator	LF	
Input	AM, FM, PhiM	Mod Ext **)	R&S SMBVB-K720
	Pulse modulation from external source*) Or External trigger or gate signal*)	Pulse Ext**)	R&S SMBVB-K22

- *) External trigger signal and external signal for the pulse modulation cannot be used simultaneously, because these signals are expected at the same connector Pulse Ext. Signal polarity and impedance are the same for both signals.
- **) The external modulation signal must have a voltage of $U_S = 1\text{ V}$ ($U_{EFF} = 0.707\text{ V}$) to achieve the displayed modulation depth and range.
Note that the input voltage does not exceed 1 V, otherwise modulation distortions can occur.

For more information, see data sheet.

Interactions and characteristics

- Some modulations exclude each other and cannot be performed simultaneously.

For more information, see data sheet.

- The settings of the modulation signal affect all analog modulations that use an internal modulation source.
- In sweep mode, LF frequency sweep is possible.
- An activated analog modulation automatically turns off:
 - I/Q modulation,
 - Arbitrary waveform generation,
 - Digital modulation and
 - Digital standards.

6.11.3 Activating Analog Modulations

- ▶ Use one of the following:
 - Select "RF > Amplitude Modulation/Frequency Modulation/Phase Modulation > State > ON".
 - Select "Mod Off > Modulation On".
 - Press the [Mod on/off] key.

[Mod on/off]

Activate one or more analog modulations and press the [Mod on/off] key to toggle the state of them all.

Pressing the key again restores the status that was active before the last switch-off.

Remote command:

`[:SOURce<hw>] :MODulation [:ALL] [:STATe]` on page 660

6.11.4 Modulation Settings

Access:

- ▶ Select "RF" > "Analog Modulation" > "Modulation Source".

The "Modulation" dialog contains all functions and settings to configure the analog modulations, the LF signal sources for performing a modulation, and the LF signal output.

The remote commands required to define these settings are described in:

- [Chapter 12.16.3.2, "SOURCE:AM Subsystem"](#), on page 660
- [Chapter 12.16.3.3, "SOURCE:FM Subsystem"](#), on page 665
- [Chapter 12.16.3.4, "SOURCE:PM Subsystem"](#), on page 670
- [Chapter 12.16.3.5, "SOURCE:PULM Subsystem"](#), on page 674
- [Chapter 12.16.10, "SOURCE:LFOutput Subsystem"](#), on page 829

6.11.4.1 Pulse Modulation

Option: see [Chapter 6.11.1, "Required Options"](#), on page 319.

Access:

- ▶ Select "RF" > "Analog Modulation" > "Pulse Modulation".

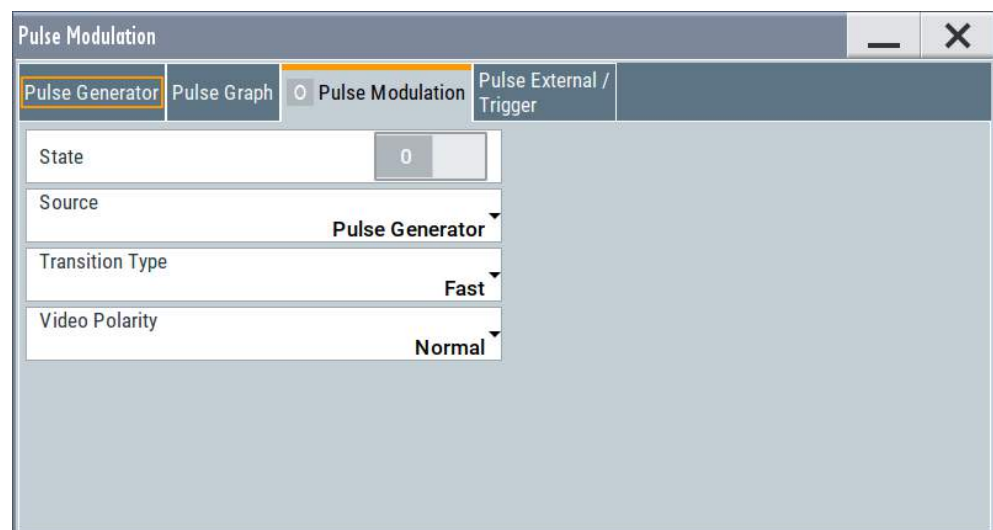

The "Pulse Modulation" dialog contains all parameters required to configure pulse modulation and pulse signal generation. It also displays the pulse signal graphically.

For an overview of the supported signals sources and related connectors, see [Chapter 6.11.2, "Modulation Types and Signal Sources"](#), on page 319.

The remote commands required to define these settings are described in [Chapter 12.16.3.5, "SOURCE:PULM Subsystem"](#), on page 674.

Settings:

State.....	323
Source.....	323
Transition Type.....	323
Video Polarity.....	323

State

Activates pulse modulation and triggers the following automatic settings:

- Pulse generator is activated.
The signal is output at the Pulse Video connector.
To deactivate the signal output, set "Pulse Generator" > [Pulse Output State](#) > "Off".

Remote command:

[:SOURce<hw>] :PULM:STATe on page 678

Source

Selects between the internal "Pulse Generator" or an "External" pulse signal for the modulation.

"Pulse Generator"

Selects the internal generator.

See [Pulse Generator](#).

"External"

Modulation source is fed to the input connector.

See ["Signal sources"](#) on page 320.

Remote command:

[:SOURce<hw>] :PULM:SOURce on page 678

Transition Type

Selects between "Fast" or "Smoothed" slew rate (slope).

"Fast"

Enables fast transitions with shortest rise and fall times.

"Smoothed"

Flattens the slew rate, resulting in longer rise / fall times. Use this mode if you are working with devices that are sensitive to steep slopes.

Remote command:

[:SOURce<hw>] :PULM:TTYPe on page 678

Video Polarity

Sets the polarity of the internally generated pulse video (modulating) signal, related to the RF (modulated) signal.

This signal synchronizes the pulse generator signal and the RF signal.

"Normal"

The video signal level follows the RF signal, that means it is high and low simultaneously with the RF signal.

"Inverse"

Inverts the polarity between the video and the RF signal, that means it is high, when RF is low, and vice versa.

Remote command:

[:SOURce<hw>] :PULM:OUTPut:VIDeo:POLarity on page 679

6.11.4.2 FM, PhiM and AM Modulation Settings

Option: R&S SMBVB-K720

Access:

- ▶ Select "RF" > "Analog Modulation" > "Amplitude Modulation/Frequency Modulation/Phase Modulation".

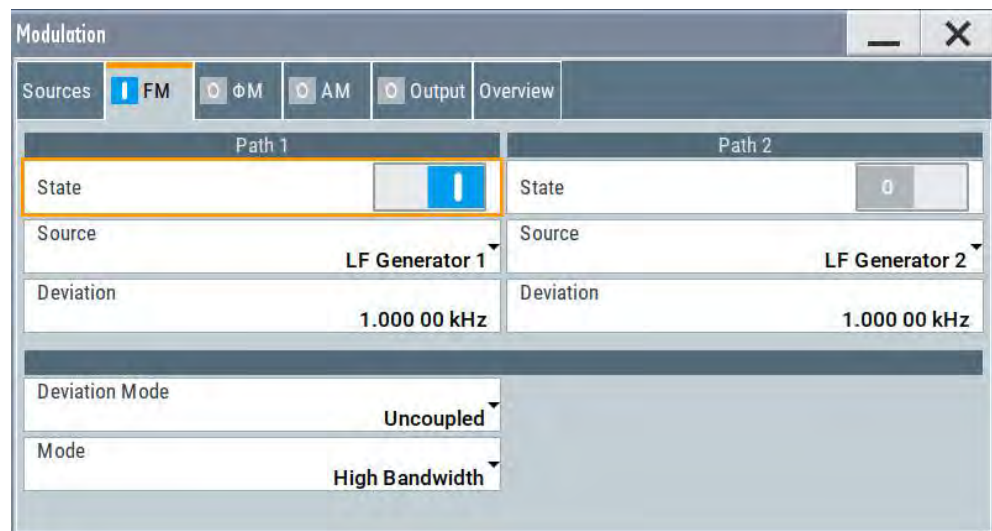

The "FM", "Φ" and "AM" tabs contain the parameters per modulation type.

Source

State.....	325
Source.....	325
FM settings.....	325
L Deviation.....	325
L Deviation Mode.....	325
L Total Depth.....	326
L Ratio Path2/Path1.....	326
L Mode.....	326
PhiM settings.....	326
L Deviation.....	326
L Deviation Mode.....	327
L Total Depth.....	327
L Ratio Path2/Path1.....	327
L Mode.....	327
AM settings.....	328
L Depth.....	328
L Sensitivity.....	328
L Deviation Mode.....	328
L Total Depth.....	329
L Ratio Path2/Path1.....	329

State

Activates a modulation.

Note: Some modulations exclude each other and cannot be performed simultaneously. For more information, see data sheet.

Remote command:

[:SOURce<hw>] :AM<ch> :STATe on page 663

[:SOURce<hw>] :FM<ch> :STATe on page 667

[:SOURce<hw>] :PM<ch> :STATe on page 671

Source

Selects the LF signal source.

You can vary the signal sources for each of the modulations.

"LF Generator 1/2"

Selects one or both of the internally generated LF signals.

See "[Source > LF Generator Settings](#)" on page 336.

"External"

Selects an externally supplied LF signal.

"Noise Generator"

Selects the internally generated noise signal.

See "[Source > Noise Generator Settings](#)" on page 340.

Remote command:

[:SOURce<hw>] :AM<ch> :SOURce on page 663

[:SOURce<hw>] :FM<ch> :SOURce on page 668

[:SOURce<hw>] :PM<ch> :SOURce on page 672

FM settings

The following settings are dedicated to FM.

Deviation ← FM settings

Sets the frequency modulation deviation in Hz.

The maximal deviation depends on the RF frequency and the selected modulation mode (see data sheet).

Maximal possible deviation is selected automatically, if one of the following applies:

- The selected deviation is too high for the particular frequency
- The selected frequency is outside of the range where deviation is possible.

A warning message indicates this situation, too.

Remote command:

[:SOURce<hw>] :FM<ch> [:DEViation] on page 667

Deviation Mode ← FM settings

Enables you to couple the LF signal of both paths and determines the mode for fixing the total deviation.

The total deviation is the sum of both paths. When the sum is exceeded, the R&S SMBV100B reports a settings conflict, but does not change the settings.

"Uncoupled" Enables you to adjust the deviation for each path independently.

"Fixed Total" Couples the deviation of both paths in per Hz. If you change the deviation of any path, the R&S SMBV100B automatically adjusts the value of the other path. The sum always results in the set [Total Depth](#).

"Fixed Ratio" Couples the deviation ratio of both paths. If you change the deviation of any path, the R&S SMBV100B adjusts the value of the other path.

Remote command:

`[:SOURce<hw>] :FM:DEVIation:MODE` on page 668

Total Depth ← FM settings

Sets the sum of the signal deviation for path 1 and path 2 in Hz when using combined sources in [Deviation Mode > Fixed Total](#).

[Deviation](#) of both paths always sum up to the value of the total deviation.

Behavior when changing any depth settings:

- Changing the total deviation adjusts the deviation of both paths proportionally.
- Changing the deviation of one path adjusts the deviation of the other path. The sum always results in the set total deviation.

Remote command:

`[:SOURce<hw>] :FM:DEVIation:SUM` on page 668

Ratio Path2/Path1 ← FM settings

Sets the deviation ratio (path2 to path1) in percent.

Example:

If the deviation in path1 is 10 kHz and the ratio is 50%, the deviation in path 2 is automatically set to 5 kHz.

Remote command:

`[:SOURce<hw>] :FM:RATio` on page 669

Mode ← FM settings

Selects the mode of the frequency modulation.

"High Bandwidth"

The maximum range for modulation bandwidth is available.

"Low Noise"

Phase modulation with phase noise and spurious characteristics close to CW mode. The range for modulation bandwidth and FM deviation is reduced (see data sheet).

Remote command:

`[:SOURce<hw>] :FM:MODE` on page 669

PhiM settings

The following settings are dedicated to PhiM.

Deviation ← PhiM settings

Sets the phase modulation deviation in radians or degrees.

The maximal deviation depends on the RF frequency and the selected modulation mode (see data sheet).

Maximal possible deviation is selected automatically, if one of the following applies:

- The selected deviation is too high for the particular frequency
- The selected frequency is outside of the range where deviation is possible.

A warning message indicates this situation, too.

Remote command:

`[:SOURce] :PM<ch> [:DEVIation]` on page 674

Deviation Mode ← PhiM settings

Enables you to couple the LF signal of both paths and determines the mode for fixing the total deviation.

The total deviation is the sum of both paths. When the sum is exceeded, the R&S SMBV100B reports a settings conflict, but does not change the settings.

"Uncoupled" Enables you to adjust the deviation for each path independently.

"Fixed Total" Couples the deviation of both paths in per Hz. If you change the deviation of any path, the R&S SMBV100B automatically adjusts the value of the other path. The sum always results in the set **Total Depth**.

"Fixed Ratio" Couples the deviation ratio of both paths. If you change the deviation of any path, the R&S SMBV100B adjusts the value of the other path.

Remote command:

`[:SOURce<hw>] :FM:DEVIation:MODE` on page 668

Total Depth ← PhiM settings

Sets the sum of the signal deviation for path 1 and path 2 in Hz when using combined sources in **Deviation Mode > Fixed Total**.

Deviation of both paths always sum up to the value of the total deviation.

Behavior when changing any depth settings:

- Changing the total deviation adjusts the deviation of both paths proportionally.
- Changing the deviation of one path adjusts the deviation of the other path. The sum always results in the set total deviation.

Remote command:

`[:SOURce<hw>] :FM:DEVIation:SUM` on page 668

Ratio Path2/Path1 ← PhiM settings

Sets the deviation ratio (path2 to path1) in per cent.

Example:

If the deviation in path1 is 10 rad and the ratio is 50%, the deviation in path 2 is automatically set to 5 rad.

Remote command:

`[:SOURce<hw>] :PM:RATio` on page 673

Mode ← PhiM settings

Selects the mode of the phase modulation.

"High Bandwidth"

The maximum range for modulation bandwidth and PhiM deviation is available.

However, phase noise increases at low frequencies, and the range of PhiM deviation is limited. This mode is suitable if you process high frequencies.

"High Deviation"

The maximum range for PhiM deviation is available.

Phase noise is improved for low frequencies compared to the default mode. The range for modulation frequency is limited (see data sheet). This mode is suitable for low modulation frequencies and/or high PhiM deviation.

"Low Noise"

Frequency modulation with phase noise and spurious characteristics close to CW mode. The range for modulation bandwidth and FM deviation is reduced (see data sheet).

Remote command:

`[:SOURce<hw>] :PM:MODE` on page 672

AM settings

The following settings are dedicated to AM.

Depth ← AM settings

Determines the depth of the modulation signal in percent.

The depth is limited by the maximum peak envelope power (PEP).

Remote command:

`[:SOURce<hw>] :AM<ch> [:DEPTTh]` on page 663

Sensitivity ← AM settings

Sets the input sensitivity of the external modulation signal.

Remote command:

`[:SOURce<hw>] :AM<ch> :SENSitivity` on page 665

Deviation Mode ← AM settings

Enables you to couple the LF signal of both paths and determines the mode for fixing the total deviation.

The total deviation is the sum of both paths. When the sum is exceeded, the R&S SMBV100B reports a settings conflict, but does not change the settings.

"Uncoupled" Enables you to adjust the deviation for each path independently.

"Fixed Total" Couples the deviation of both paths in per Hz. If you change the deviation of any path, the R&S SMBV100B automatically adjusts the value of the other path. The sum always results in the set **Total Depth**.

"Fixed Ratio" Couples the deviation ratio of both paths. If you change the deviation of any path, the R&S SMBV100B adjusts the value of the other path.

Remote command:

`[:SOURce<hw>] :FM:DEVIation:MODE` on page 668

Total Depth ← AM settings

Sets the sum of the signal deviation for path 1 and path 2 in Hz when using combined sources in [Deviation Mode > Fixed Total](#).

[Deviation](#) of both paths always sum up to the value of the total deviation.

Behavior when changing any depth settings:

- Changing the total deviation adjusts the deviation of both paths proportionally.
- Changing the deviation of one path adjusts the deviation of the other path. The sum always results in the set total deviation.

Remote command:

`[:SOURce<hw>] :FM:DEVIation:SUM` on page 668

Ratio Path2/Path1 ← AM settings

Sets the deviation ratio of the signal depth for path 2 to path 1 in per cent when using combined sources.

Using external LF signals, the R&S SMBV100B indicates the [Sensitivity](#) per Volts for the input signal.

Remote command:

`[:SOURce<hw>] :AM:RATio` on page 664

6.11.4.3 Pulse Generator

Option: see [Chapter 6.11.1, "Required Options"](#), on page 319.

Access:

- ▶ Select "RF" > "Analog Modulation" > "Pulse Generator".

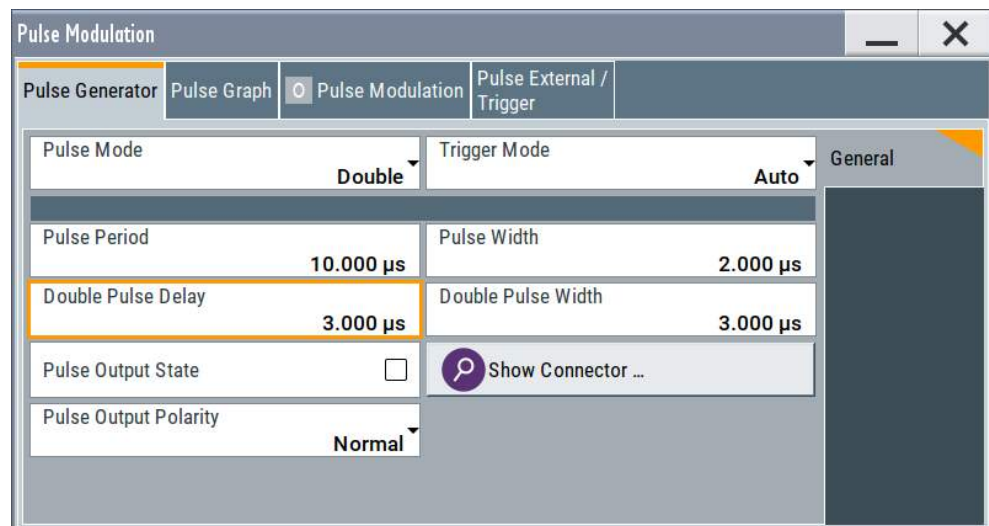

The "Pulse Generator" tab contains the settings for creating the pulse modulation signal internally.

- [Pulse Generator > General Settings](#)..... 330

Pulse Generator > General Settings

Access:

- ▶ Select "RF" > "Analog Modulation" > "Pulse Generator".

Settings

Pulse Mode.....	330
Trigger Mode.....	330
Pulse Period.....	332
Pulse Width.....	332
Double Pulse Width.....	333
Pulse Delay.....	333
Double Pulse Delay.....	333
Pulse Output State.....	333
Show Connector.....	333
Pulse Output Polarity.....	333
Execute Single Trigger.....	333

Pulse Mode

Sets the operating mode of the pulse generator. Depending on the selection, the instrument displays the associated parameters.

"Single" Generates a single pulse in one pulse period.

"Double" Generates two pulses in one pulse period.

Remote command:

[: SOURce<hw>] : PULM:MODE on page 676

Trigger Mode

Selects between continuous triggering or triggering initiated by a trigger event from an external signal.

See also ["Input and output connectors"](#) on page 320.

"Auto" Generates the internal modulation signal continuously.

"Single" The pulse generator is triggered by an internal trigger event, initiated with [Execute Single Trigger](#).
The pulse signal is generated once.

"Ext Single" Generates a single pulse signal, triggered by an external signal.

"Ext Triggered" Generates the pulse signal each time an external trigger event occurs.

Example: Generation of single pulse signal ("Pulse Mode = Single") using "Trigger Mode = Ext Triggered"

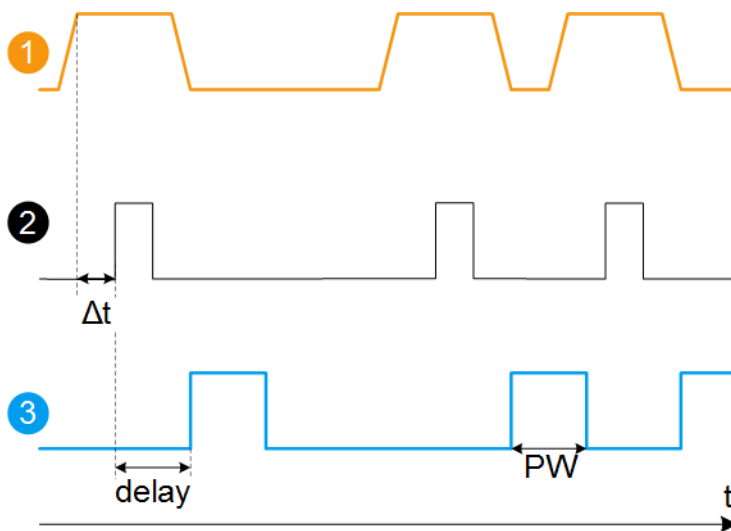

- 1 = External trigger signal input with "Trigger Input Polarity = Normal" (the positive slope is active)
- 2 = Sync signal
- 3 = Pulse signal
- Δt = Trigger delay between the trigger and the sync signal start; see data sheet
- delay = "Pulse Delay = 100 ns"
- PW = "Pulse Width = 100 ns"

Example: Generation of double pulse signal ("Pulse Mode = Double") using "Trigger Mode = Ext Triggered"

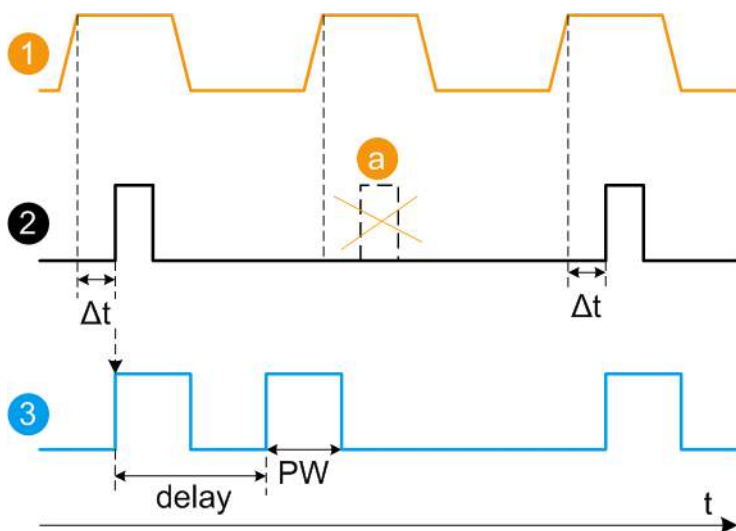

- 1 = External trigger signal input with "Trigger Input Polarity = Normal" (the positive slope is active)
- 2 = Sync signal

- 3 = Pulse signal
- a = Trigger signal during double pulse generation is without effect
- Δt = Trigger delay between the trigger and the sync signal start; see data sheet
- delay = "Double Pulse Delay = 200 ns"; the first pulse starts without a delay
- PW = "Double Pulse Width = 100 ns"

"Ext Gated" Generates the signal triggered by an external gate signal.

Example: Generation of single pulse signal ("Pulse Mode = Single") using "Trigger Mode = Ext Gated"

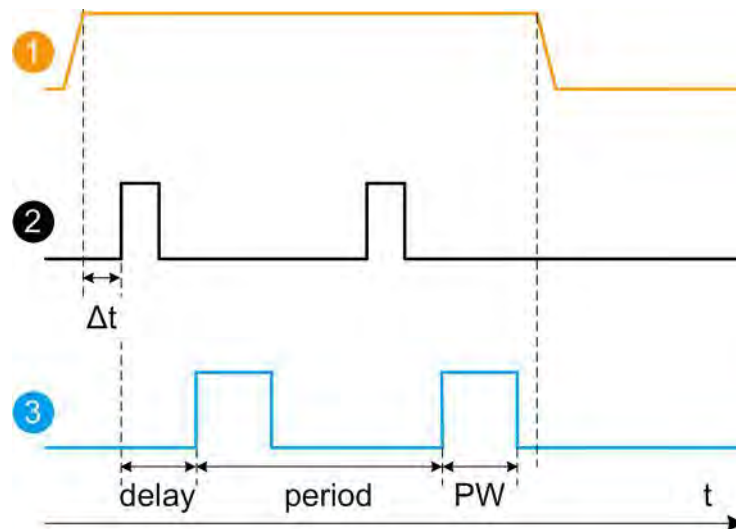

- 1 = External trigger signal input with "Trigger Input Polarity = Normal" (the positive slope is active)
- 2 = Sync signal
- 3 = Pulse signal
- Δt = Trigger delay between the trigger and the sync signal start; see data sheet
- delay = "Pulse Delay = 100 ns"
- PW = "Pulse Width = 100 ns"
- period = "Pulse Period = 300 ns" (time between the pulse start of two consecutive pulses)
- a = Gate active duration (pulses are generated during the gate active part)

Remote command:

`[:SOURCE<hw>] :PULM:TRIGger:MODE` on page 676

Pulse Period

Sets the repetition rate of the generated pulse signal.

Remote command:

`[:SOURCE<hw>] :PULM:PERiod` on page 677

Pulse Width

Sets the pulse duration of the generated pulse signal.

Note: The pulse width must be at least 20 ns less than the set pulse period.

Remote command:

`[:SOURCE<hw>] :PULM:WIDTH` on page 677

Double Pulse Width

Sets the width of the second pulse.

Remote command:

`[:SOURce<hw>] :PULM:DOUBle:WIDTh` on page 678

Pulse Delay

Sets the pulse delay. The pulse delay determines the time that elapses after a trigger event before pulse modulation starts. The pulse delay is not effective for double pulse generation.

Remote command:

`[:SOURce<hw>] :PULM:DELay` on page 677

Double Pulse Delay

Sets the delay from the start of the first pulse to the start of the second pulse.

Remote command:

`[:SOURce<hw>] :PULM:DOUBle:DELay` on page 677

Pulse Output State

Activates the output of the pulse modulation signal.

Remote command:

`[:SOURce<hw>] :PGENerator:OUTPut [:STATe]` on page 858

**Show Connector**

Accesses a dialog that displays the physical location of the selected connector on the front/rear panel of the instrument.

Pulse Output Polarity

Sets the polarity of the pulse output signal.

Remote command:

`[:SOURce<hw>] :PGENerator:OUTPut:POLarity` on page 857

Execute Single Trigger

If "Trigger Mode = Single", initiates a single pulse sequence manually.

Remote command:

`[:SOURce] :PULM [:INTernal] [:TRAIIn] :TRIGger:IMMediate` on page 676

6.11.4.4 Pulse Graph

Option: see [Chapter 6.11.1, "Required Options"](#), on page 319.

Access:

► Select "RF" > "Analog Modulation" > "Pulse Modulation > Pulse Graph".

The pulse graph is the graphical representation of the current pulse signal.

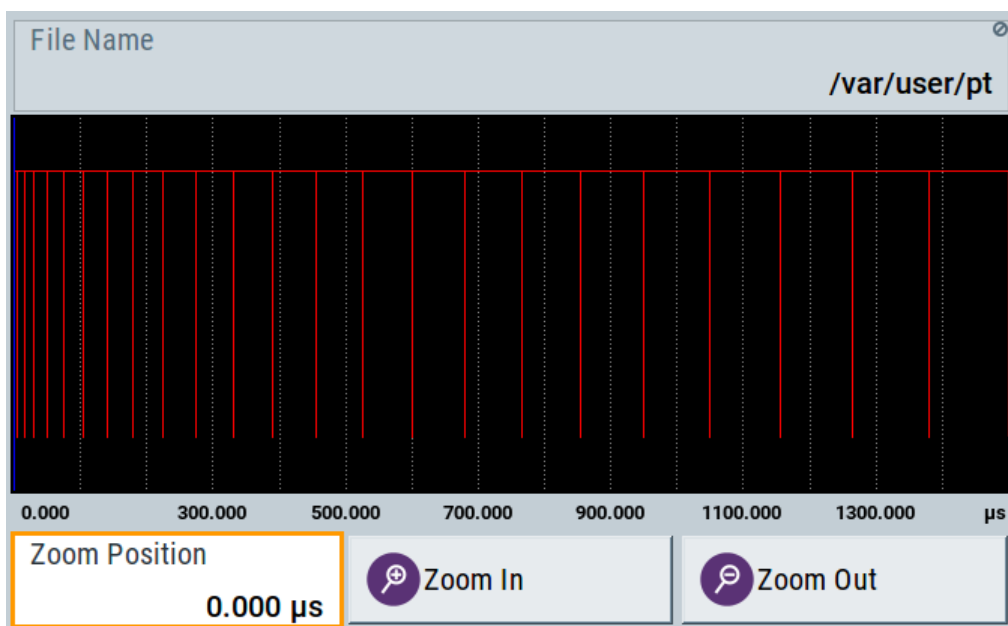

The height of the bars corresponds to the selected amplitude of the pulse signal.

Zooming

You can zoom into the diagram to visualize the graph in more detail:

- "Zoom Position": Sets the focus on the time axis where to enlarge the graph.
- "Zoom In": Enlarges the graph at the selected position.
- "Zoom Out" for the reverse operation.

6.11.4.5 Pulse External /Trigger Settings

Access:

- ▶ Select "RF" > "Analog Modulation" > "Pulse Modulation > Pulse External /Trigger".

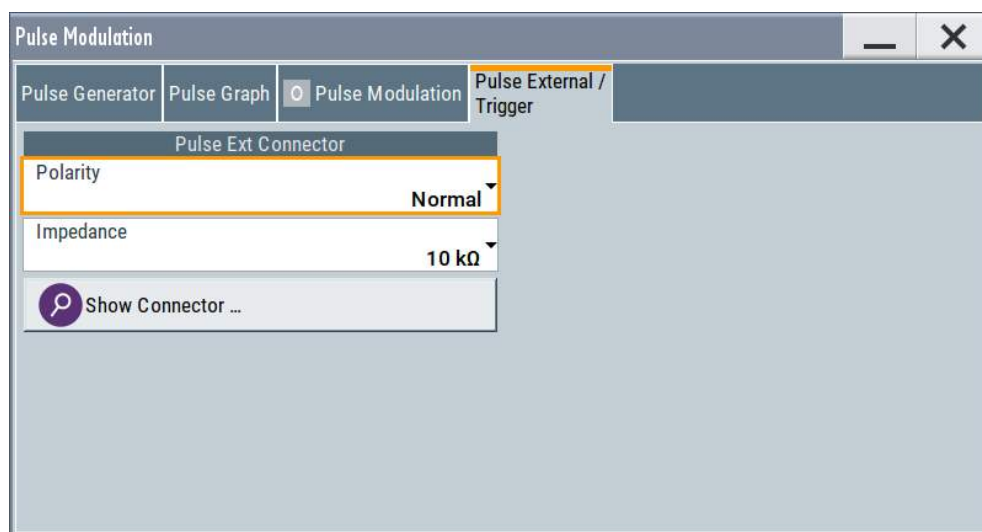

The dialog comprises the characteristics of the Pulse Ext connector. This connector is common for the pulse generator and the pulse modulator. For an overview, see "Input and output connectors" on page 320.

Settings

Polarity.....	335
Impedance.....	335
Show Connector.....	335

Polarity

Sets the polarity of the active slope of a pulse input signal, that is the external pulse modulation signal.

Remote command:

[:SOURce<hw>] :PULM:POLarity on page 679

Impedance

Sets the input impedance.

Remote command:

[:SOURce<hw>] :PULM:IMPedance on page 679



Show Connector

Accesses a dialog that displays the physical location of the selected connector on the front/rear panel of the instrument.

6.11.4.6 FM, PhiM and AM Modulation Sources

Access:

- ▶ Select "RF" > "Analog Modulation" > "Modulation Source...".

In the "Sources" tab, you can configure an LF modulation signal for performing analog modulations. It includes the setting parameters of the internal LF-and multi-function generators, the noise generator, and an external signal source.

• Source > LF Generator Settings.....	336
• Source > External Settings.....	339
• Source > Noise Generator Settings.....	340

Source > LF Generator Settings

Access:

- ▶ Select "RF" > "Analog Modulation" > "Modulation Source... > LF Generator".

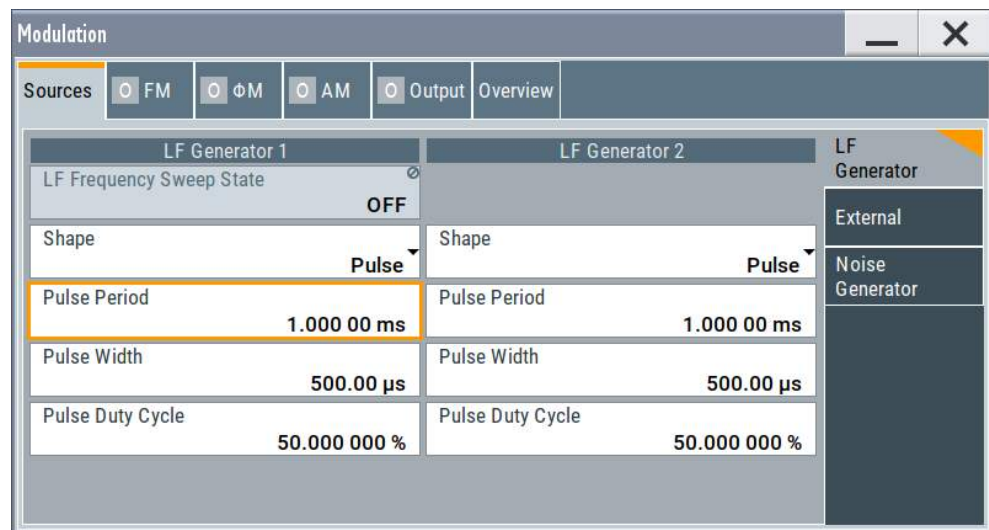

The internal LF signal can be used as modulation signal source for any of the analog modulations. The LF signal applies to all modulations which use the internal modulation signal. Therefore, any modification of the LF signal influences immediately all currently active modulations.

Settings

State (LF frequency sweep).....	336
Shape.....	337
Frequency.....	338
Period.....	338
Pulse Width.....	338
Pulse Duty Cycle.....	338
Triangle Rise.....	338
Trapezoid Rise / Fall.....	339
Trapezoid High.....	339

State (LF frequency sweep)

Status of the LF frequency sweep signal.

You find this parameter in two dialogs:

- "LF Frequency Sweep" turns on/off the signal generation. See [Sweep Mode Settings](#) for access.
- "Analog Modulation Sources" displays the current state (read-only). If it is turned on, this dialog provides the varying sweep frequency, see [Current Frequency](#).

Note: Active sweep mode deactivates other sweeps or lists and vice versa.

Remote command:

[:SOURce<hw>] :LFOutput:FREQuency:MODE on page 833

Shape

Selects the waveform shape of the LF signal.

The "Triangle" and "Trapezoid" waveforms require option R&S SMBVB-K24.

"Sine"

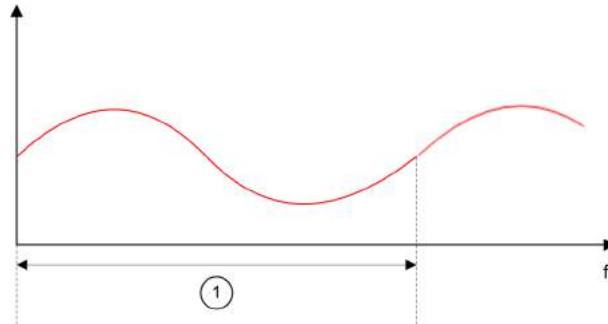

1 = Period

"Pulse"

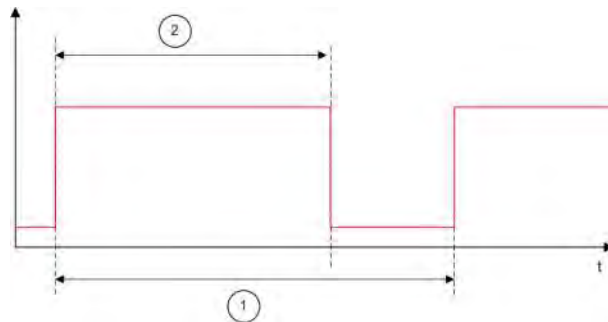

1 = Pulse period
2 = Pulse width

"Triangle"

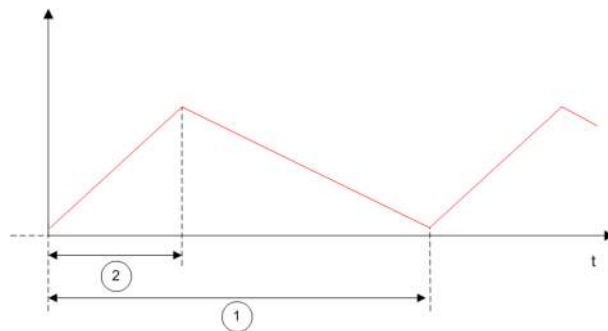

1 = Triangle period
2 = Triangle rise

"Trapezoid"

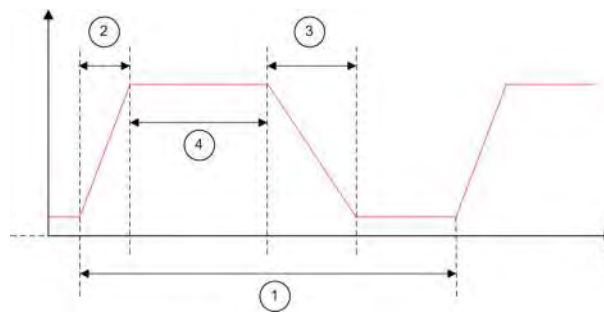

- 1 = Trapezoid period
- 2 = Trapezoid rise
- 3 = Trapezoid fall
- 4 = Trapezoid high

Remote command:

`[:SOURce<hw>] :LFOutput<ch> :SHAPE` on page 836

Frequency

Sets the frequency of the LF generator for sine signals.

Set the signal shape with the parameter [Shape](#).

Remote command:

`[:SOURce] :LFOutput<ch> :FREQUENCY` on page 832

Period

Sets the repetition rate of the generated LF signal for triangle, trapezoid or pulse shapes, see [Shape](#).

The period of sine signals is calculated from the selected [Frequency](#)

Remote command:

`[:SOURce<hw>] :LFOutput<ch> :SHAPE :TRAPeZe :PERiod` on page 838

`[:SOURce<hw>] :LFOutput<ch> :SHAPE :TRIangle :PERiod` on page 838

`[:SOURce<hw>] :LFOutput<ch> :SHAPE :PULSe :PERiod` on page 837

Pulse Width

Sets the pulse duration of the generated pulse signal.

Remote command:

`[:SOURce<hw>] :LFOutput<ch> :SHAPE :PULSe :WIDTh` on page 837

Pulse Duty Cycle

Sets the ratio between the pulse duration and the pulse period in percent.

Remote command:

`[:SOURce<hw>] :LFOutput<ch> :SHAPE :PULSe :DCYClE` on page 836

Triangle Rise

Sets the time required for the triangle signal to change from low level to high level.

Remote command:

`[:SOURce<hw>] :LFOutput<ch> :SHAPE :TRIangle :RISE` on page 838

Trapezoid Rise / Fall

Sets the time required for the trapezoid signal to change from low level to high level, and vice versa.

Remote command:

[:SOURce<hw>] :LFOutput<ch>:SHAPE:TRAPeZe:RISE on page 838

[:SOURce<hw>] :LFOutput<ch>:SHAPE:TRAPeZe:FALL on page 837

Trapezoid High

Sets how long the trapezoid signal is at high level.

Remote command:

[:SOURce<hw>] :LFOutput<ch>:SHAPE:TRAPeZe:HIGh on page 837

Source > External Settings

Access:

- ▶ Select "RF" > "Analog Modulation" > "Modulation Source... > External".

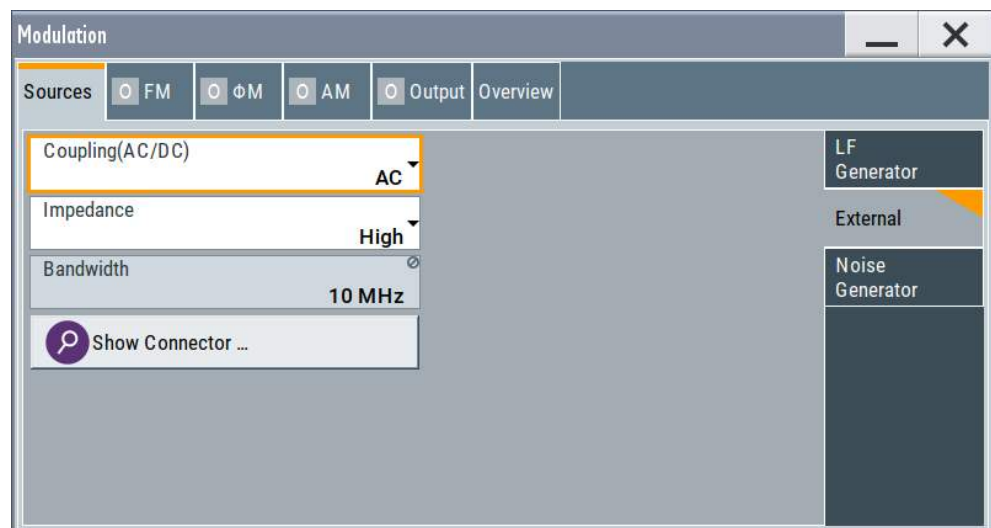

The "External" settings section contains all parameters required to configure the signal of an externally supplied LF signal.

Settings

Coupling (AC/DC).....	339
Impedance.....	340
Bandwidth.....	340
Show Connector.....	340

Coupling (AC/DC)

Selects the coupling mode (AC or DC) for the external signal.

"AC"	Disconnects the DC voltage component and uses only the AC component of the modulation signal.
"DC"	Uses the modulation signal with both components, AC and DC.

Remote command:

[:SOURce<hw>] : INPut : MODext : COUPling on page 821

Impedance

Sets the impedance for the externally supplied signal.

Remote command:

[:SOURce<hw>] : INPut : MODext : IMPedance<ch> on page 821

Bandwidth

Displays the maximum bandwidth of the external LF signal.

Remote command:

[:SOURce] : LFOutput<ch> : BANDwidth? on page 832



Show Connector

Accesses a dialog that displays the physical location of the selected connector on the front/rear panel of the instrument.

Source > Noise Generator Settings

Access:

- ▶ Select "RF" > "Analog Modulation" > "Modulation Source... > Noise Generator".

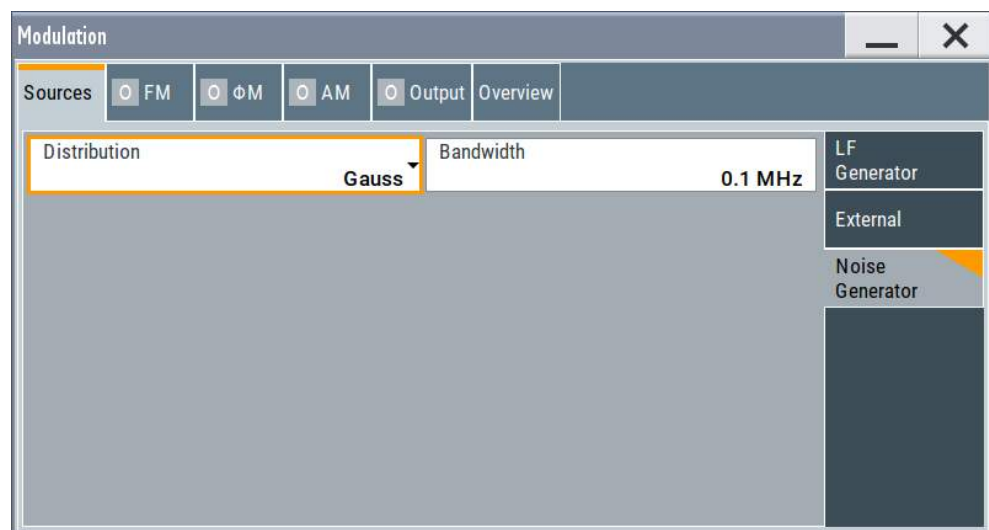

The "Noise Generator" settings contain all parameters to configure the signal of the internal noise generator.

Settings

Distribution.....	340
Bandwidth.....	341

Distribution

Selects the distribution of the noise power density.

"Gauss" Generates the noise power according to a Gaussian distribution.

"Equal" Generates an evenly distributed noise.

Remote command:

`[:SOURce<hw>] :NOISe:DISTRibution` on page 856

Bandwidth

Sets the noise bandwidth as distinct value.

You can set the bandwidth between 100 kHz and 10 MHz in 100 KHz steps.

Remote command:

`[:SOURce<hw>] :NOISe:BANDwidth|BWIDth` on page 856

`[:SOURce<hw>] :NOISe:BWIDth:STATe` on page 856

6.11.4.7 LF Signal Output Settings

Access:

- ▶ Select "RF" > "Analog Modulation" > "LF Output".

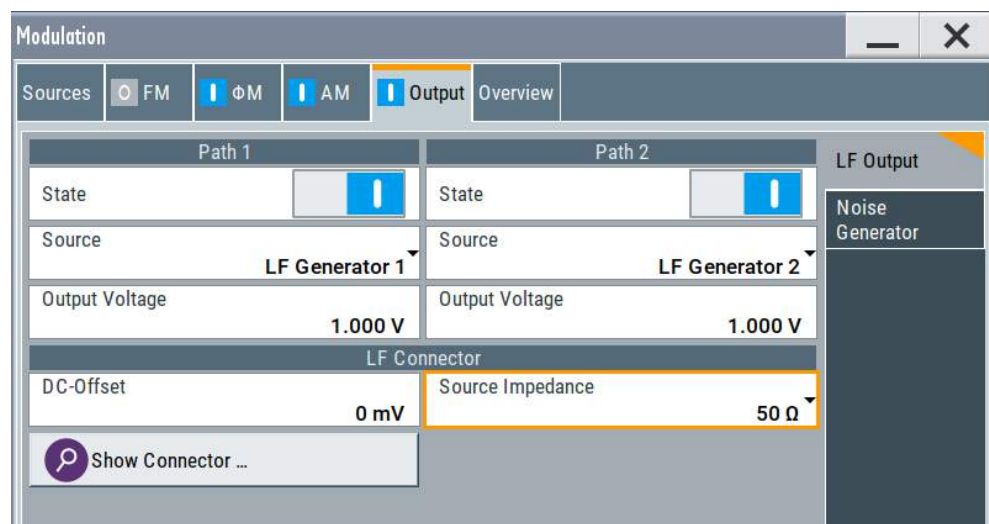

In the "LF Output" tab, you can configure the signal at the LF outputs, determine the output voltage or add a DC offset. Activate both paths to output the sum signal of the two sources.

See also [Chapter 6.11.4.8, "Overview"](#), on page 343.

Settings:

State	342
Source	342
Show Connector	342
Output Voltage	342
DC-Offset	342
Source Impedance	342

Noise Generator.....	343
L Noise Density.....	343
L Noise Level.....	343

State

Activates the output of the LF signal.

Remote command:

[\[:SOURce\]:LFOutput<ch>\[:STATe\]](#) on page 834

Source

Select the sources for the signal output at the LF connector. If you activate path 1 *and* 2, those sources are added.

Use the "Show Connector" function to find out where this connector is located.

"LF Generator 1/2"

Selects one of internally generated LF signals.

"AM"

Option: R&S SMBVB-K720

Selects the AM signal.

"FM/PhiM"

Option: R&S SMBVB-K720

Selects the signal also used by the frequency or phase modulations.

"Noise Generator"

Selects the internally generated noise signal.

"External"

Selects an externally supplied LF signal.

Remote command:

[\[:SOURce\]:LFOutput<ch>:SOURce](#) on page 835

**Show Connector**

Accesses a dialog that displays the physical location of the selected connector on the front/rear panel of the instrument.

Output Voltage

Sets the voltage (peak) of the selected LF output source.

Remote command:

[\[:SOURce\]:LFOutput<ch>:INTernal:VOLTage](#) on page 834

DC-Offset

Adds a DC offset to the LF output signal.

Remote command:

[\[:SOURce\]:LFOutput:OFFSet](#) on page 835

Source Impedance

Selects the output impedance of the LF generator.

"50 Ω"

Selects an output impedance of 50 Ω.

"600 Ω"

Selects an output impedance of 600 Ω.

Remote command:

[:SOURce] :LFOutput :SIMPedance on page 835

Noise Generator

Access:

- Select "RF" > "Analog Modulation" > "LF Output > Noise Generator".

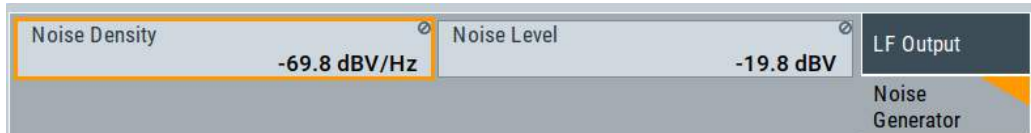

Noise Density ← Noise Generator

Indicates the level of the noise signal for a bandwidth of 1 Hz (relative).

Remote command:

[:SOURce<hw>] :NOISe:LEVel:RELative? on page 856

Noise Level ← Noise Generator

Indicates the level of the noise signal per Hz within the total bandwidth (absolute).

Remote command:

[:SOURce<hw>] :NOISe:LEVel [:ABSolute] ? on page 857

6.11.4.8 Overview

Option: AM and FM/PM require R&S SMBVB-K720

Access:

- ▶ Select "RF" > "Analog Modulation" > "Modulation Source... > Overview".

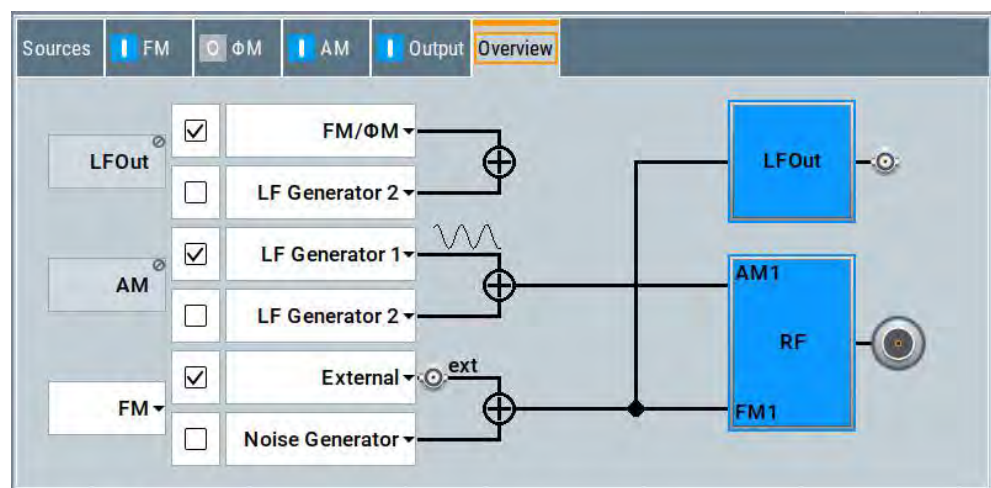

Blue color = Active output signal (AM and FM)

Gray color = Inactive output signal (LF Out)

Miniature graph = Indicates an active source

Connectors = Indicate a connector (e.g. external signal) is involved in the path of the signal

The "Overview" tab is an interactive diagram that indicates the active modulations and the signal being output.

Here you can:

- Select the output signal ("LF Out") per path; the setting acts as the parameter "LF Output Source"
- Select the source for each modulation and modulation path; the setting acts as the parameter "Source"
- Activate modulation per path; the setting acts as the parameter "State"
To generate a two-tone signal composed from the two paths of the same modulation type, activate both paths.
- Activate "FM" or "PhiM"; the two modulations are mutually exclusive.

LFOut

Label for the LF output settings in the overview.

Remote command:

n.a.

AM

Label for the amplitude modulation settings in the overview.

Remote command:

n.a.

FM/PhiM

Selects the modulation signal to be assigned to the output. You can assign the frequency or phase modulated signal.

Remote command:

n.a.

6.11.5 How to Generate an Amplitude Modulated Signal

The following examples use the internal LF generator.

To set the frequency and level of the RF signal

1. Press [Preset] to start from a defined state.
2. In the status bar, set "Frequency = 2 GHz".
3. Set "Level = -20 dBm".

To configure the modulation signal (LF generator)

1. Select "RF" > "Analog Modulation" > "Modulation Source".
2. In the "Sources" tab, select "Shape > Sine".
3. Set "Frequency = 20 kHz".

The period is calculated automatically and indicates "Period = 50.00 μ s".

To configure the amplitude modulation settings

1. In "Modulation" dialog, select the "AM" tab.
2. Set "Source = LF Generator1"
3. Set "Depth = 30%"
4. Select "State = I" to activate the modulation.
5. Set "RF > On" to enable signal output.

6.11.6 How to Generate a Pulse Modulated Signal

The following example uses the internal pulse generator.

To set the frequency and level of the RF signal

1. Press [Preset].
2. In the status bar, set "Frequency = 4 GHz".
3. Set "Level = -25 dBm".

To configure the pulse generator

1. Select "RF" > "Analog Modulation" > "Pulse Generator".
2. Select "Pulse Mode = Double".
3. Set "Pulse Period = 10 us".
4. Set "Pulse Width = 2 us".
5. Set "Double Pulse Width = 1.2 us".
6. Set "Double Pulse Delay = 4.5 us".
7. Activate "Pulse Output State".
8. Set "Trigger Mode = Auto".

In the "Pulse Graph" tab, you can view the generated pulse signal graphically.

To enable pulse modulation

1. Select the "Pulse Modulation" tab.
2. Set "State = I" to activate pulse modulation.
3. Set "RF > On" to enable signal output.

6.12 Improving Level Performance

To adapt the RF output signal to specific needs in your application, the R&S SMBV100B offers different functions:

- **Attenuator**
Basis for a wide dynamic range is a fast, wear and tear free electronic attenuator. It provides also the generation of a constant VSWR (uninterrupted level) signal, highest level accuracy, noise suppression or compensation of external losses of cables.
See [Chapter 6.12.1, "Attenuator"](#), on page 346.
- **Automatic Level Control (ALC)**
The automatic level control system ensures stable RF signals with highest absolute level accuracy over temperature and time.
See [Chapter 6.12.2, "ALC - Automatic Level Control"](#), on page 349.
- **User correction (UCOR)**
The user correction function allows you to compensate frequency responses of external setups (e.g. losses of cables) and achieve a stable input signal over frequency directly at the DUT.
See [Chapter 6.12.3, "User Correction"](#), on page 352.
- **Power sensors**
The R&S NRP power sensors support RF signal level optimization by determining the attenuation characteristics of downstream devices or cables, or by monitoring the RF signal level at the output directly. The R&S SMBV100B uses the readings of a sensor for compensation of losses and thus improving the accuracy of the RF signal level.
You can configure the measurement parameters of a power sensor directly in the R&S SMBV100B and monitor its readings, including calibration.
See:
 - [Chapter 6.12.4, "Using Power Sensors"](#), on page 363
 - [Chapter 6.12.5, "How to Calibrate the Power Level with an R&S NRP Power Sensor"](#), on page 374
 - [Chapter 6.12.4.2, "NRP Sensor Mapping"](#), on page 365
 - [Chapter 6.12.4.3, "NRP Power Viewer"](#), on page 366

6.12.1 Attenuator

The R&S SMBV100B is equipped with an electronic step attenuator for fast, wear and tear free level settings.

About the attenuator

The attenuator is an electronic component which enables you to vary the amplitude of the RF signal in a wide range. Basically, it is characterized by low VSWR (voltage standing wave ratio) up to 6 GHz over the full level range.

According to the requirements of your application, you can select different attenuator characteristics.

The following are examples of test requirements and the corresponding configuration:

- Automatic configuration
Select standard operation mode ("Auto"), in which the generator adjusts the attenuation of the RF output signal automatically
- Compensation for cable loss
You can compensate the loss of a cable connection by a higher output power
- DUT tests under low signal to noise conditions
Low output power is suitable to test the behavior of a DUT under low signal to noise conditions.
- Uninterrupted level settings with constant VSWR
A fix attenuation value is required for obtaining uninterrupted level settings with constant VSWR.
The configuration "RF Off Mode > Unchanged" ensures that constant VSWR is maintained if you turn the signal off and on again.
- Noise sensitive applications
The parameter "RF OFF Mode > Full Attenuation" sets maximum attenuation and thus suppresses noise when you turn off the RF signal.

6.12.1.1 Attenuator Settings

Access:

- ▶ Select "RF" > "RF Level" > "Level > Attenuator".

In the "Attenuator" dialog, you can select the operating mode of the electronic attenuator, the instrument is equipped with.



The remote commands required to define these settings are described in [Chapter 12.13, "OUTPut Subsystem"](#), on page 617 and [Chapter 12.16.15, "SOURce:POWer Subsystem"](#), on page 859.

Settings

Mode	347
Level Range	348
RF OFF Mode	348

Mode

Determines the operating mode of the attenuator.

"Auto"	Adjusts the attenuator settings automatically.
"Fixed"	Fixes the attenuator and amplifier paths for the current RF level and provides signal output with constant output VSWR. The resulting level range is indicated under " Level Range " on page 348.

Remote command:

[:OUTPut<hw>:AMODE](#) on page 618

Level Range

Shows the interruption-free range of the level that you can use in the selected mode.

Remote command:

[:OUTPut<hw>:AFIXed:RANGe:LOWer?](#) on page 619

[:OUTPut<hw>:AFIXed:RANGe:UPPer?](#) on page 619

RF OFF Mode

Determines the state of the attenuator, when the RF signal is switched off.

The setting is not affected by an instrument preset ([Preset] key or *RST) and the "Save/Recall" function. It is reset only by factory preset.

"Unchanged" Freezes the setting of the attenuator.
Use this mode if a constant VSWR (Voltage Standing Wave Ratio) is required.

"Full Attenuation"
Switches to the maximum attenuation.
Use this mode for applications that require a high level of noise suppression.

Remote command:

[\[:SOURce<hw>\]:POWER:ATTenuation:RFOff:MODE](#) on page 862

6.12.1.2 Reverse Power Protection

The R&S SMBV100B is equipped with a reverse power protection circuit.

The reverse power protection is tripped when the power of signals reflected from the load or external signals applied to the RF output get too high. A relay opens and interrupts the internal connection to the RF output. This condition is indicated in the status bar by the "Overload" status message.

Overload

If an "Overload" status message is indicated in the status bar, perform the following:

- Remove the cause for the overload
- Press the [RF on/off] key to reset the overload protection

The RF input is activated when the overload protection is reset.

Remote command:

[:OUTPut<hw>:PROTection:TRIPped?](#) on page 619

[:OUTPut<hw>:PROTection:CLEar](#) on page 619

6.12.2 ALC - Automatic Level Control

The R&S SMBV100B is equipped with an automatic level control (ALC) unit to obtain best RF level accuracy.

About ALC

ALC is an adaptive control system to stabilize the RF output level. It continuously monitors the current level and adjusts it to keep a steady state over temperature and time.



ALC is active in almost all applications by default.

However, the **Pulse Modulation** mode excludes ALC, as the control loop would detect incorrect values and result in level deviations.

Also note that ALC can detect incorrect values in **multi-transmitter** test setups. If multiple generators are coupled, reverse power can affect the ALC readings, which can lead to an incorrect RF output power.

ALC States and their effects

The following description basically explains the ALC states and their principle of operation:

- "Auto"
Adjusts the output level to the operating conditions automatically. ALC is active in almost all operating modes.
- "On"
Activates the internal level control permanently, regardless of the operating conditions. This setting provides the highest level accuracy.
- "Off (Table)"
Deactivates internal level control loop. The instrument calculates every level setting using the attenuation values from the internal (ALC) table. Level attenuation between two table values is done with linear interpolation. This mode enables you to perform a strictly monotonic, but not quite as precise level adjustment.
- "Table & On"
Starts with the associated value of the internal level table and then activates the automatic level control. This mode achieves maximum level accuracy and fast setting times.
This mode is useful if your goal is to improve the signal/intermodulation ratio in CW mode for multi-transmitter measurements.

The R&S SMBV100B displays the level control setting as a status message in the info line.



The ALC modes "Off (Sample & Hold)" and "Sample & On" use a short sample pulse to set the level control. The level of this sample pulse corresponds to the sample level setting of the full PEP of the R&S SMBV100B. It does not consider any signal headroom, e.g. applied to a user defined ARB waveform.

NOTICE**Risk of DUT damage due to high input power**

The settings combination "ALC > Sample Level > Full" and "ALC > State > Off (Sample & Hold)" or "ALC > State > Sample & On" results in signals with large headroom. With this settings combination, the R&S SMBV100B generates a short sample pulse with full RF output power.

To protect the DUT from damage due to high input power, use the setting "Sample Level > Attenuated" or "Sample Level > Minimum".

6.12.2.1 ALC Settings

Access:

- ▶ Select "RF" > "RF Level" > "Automatic Level Control".

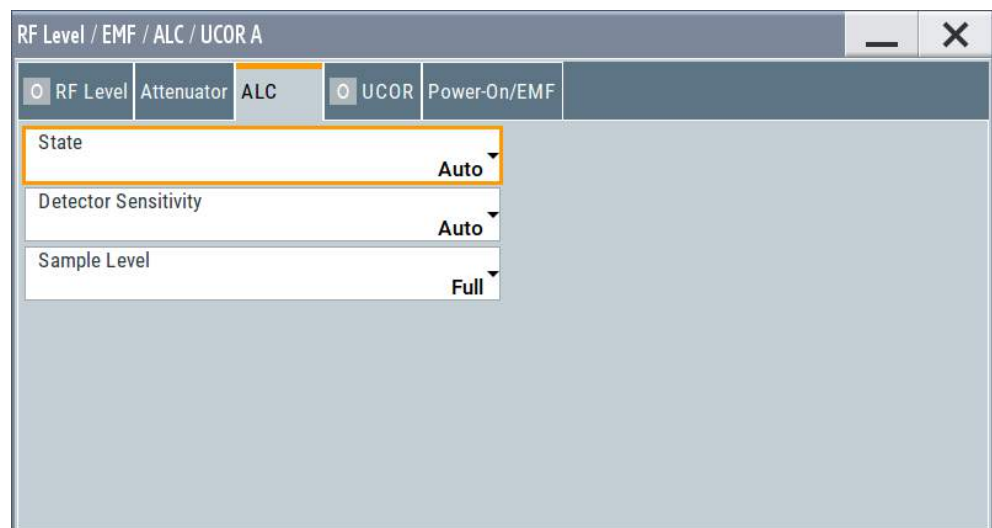

In the "ALC" dialog, you can configure the settings for the automatic level control of the RF signal to achieve optimal accuracy.

The remote commands required to define these settings are described in [Chapter 12.16.15, "SOURCE:POWER Subsystem"](#), on page 859.

Settings

State.....	350
Detector Sensitivity.....	351
Sample Level.....	352

State

Selects the internal level control mode.

Find further details about the individual settings in ["ALC States and their effects"](#) on page 349. It covers an overview of the functionality and indicates what is to be considered.

"Auto"	Selects the most appropriate ALC mode automatically.
"On"	Activates ALC permanently.
"Sample & On"	<p>Starts the internal level control with the first change.</p> <p>The ALC modes "Off (Sample & Hold)" and "Sample & On" use a short sample pulse to set the level control. The level of this sample pulse corresponds to the sample level setting of the full PEP of the R&S SMBV100B. It does not consider any signal headroom, e.g. applied to a user defined ARB waveform.</p> <p>Notice: Risk of DUT damage due to high input power</p> <p>The settings combination "ALC > Sample Level > Full" and "ALC > State > Off (Sample & Hold)" or "ALC > State > Sample & On" results in signals with large headroom. With this settings combination, the R&S SMBV100B generates a short sample pulse with full RF output power.</p> <p>To protect the DUT from damage due to high input power, use the setting "Sample Level > Attenuated" or "Sample Level > Minimum".</p>
"Off (Table)"	Controls the level using the attenuation values of the internal ALC table.
"Table & On"	Starts with the attenuation setting from the table and continues with automatic level control.

Remote command:

`[:SOURce<hw>] :POWer:ALC [:STATe]` on page 860

Detector Sensitivity

Determines the path of the internal level detector.

The level detector of the ALC has multiple paths distinguished by their sensitivity.

"Auto"	Selects the detector path automatically, according to the given level. This mode is the recommended operation mode.
"Low"	Selects the detector path with low sensitivity. This setting is intended for signals with high internal electronic levels.
"Med"	Selects the path with medium sensitivity. This setting corresponds to normal mode. It is intended for signals with medium internal electronic levels.
"High"	Selects the detector path with high sensitivity, intended for signals with low internal electronic levels.
"Fix"	Fixes the last set sensitivity setting.

Remote command:

`[:SOURce<hw>] :POWer:ALC:DSENSitivity` on page 861

Sample Level

Determines the level at the output of the instrument during the sample process.

"Full"	Provides the currently set level. NOTICE: Risk of DUT damage due to high input power The settings combination "ALC > Sample Level > Full" and "ALC > State > Off (Sample & Hold)" or "ALC > State > Sample & On" results in signals with large headroom. With this settings combination, the R&S SMBV100B generates a short sample pulse with full RF output power. To protect the DUT from damage due to high input power, use the setting "Sample Level > Attenuated" or "Sample Level > Minimum".
"Attenuated"	Attenuates the signal for about 40 dB to protect external devices like the DUT from damage due to high input power.
"Minimum"	Attenuates the signal level with the maximum value.

Remote command:

`[:SOURce<hw>] :POWer:ALC:SLEVel` on page 862

6.12.3 User Correction

The R&S SMBV100B supports a correction function to compensate external losses, caused, for example, by the RF cable, to achieve a precise target input level at the DUT.

The signal at the RF outputs of the R&S SMBV100B is flat. However, the DUT is usually not connected directly to the outputs of the instrument but rather via connecting cables. Components like cables, power combiners, switches or mixers can affect the signal flatness at the DUT input.

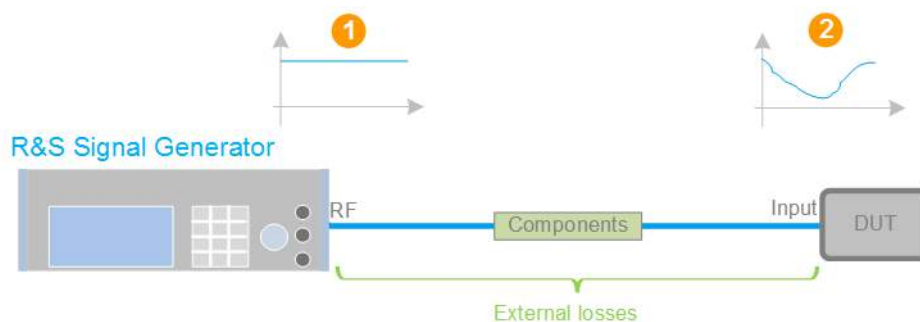

Figure 6-18: Effect of external losses on the signal flatness at the DUT input

DUT	= Device under test
Components	= Designation of all components between the measurement equipment and the DUT, e.g. cables
1	= Flat signal at the outputs of the R&S SMBV100B
2	= Signal received at the DUT, incl. the external losses

About UCOR

User correction (UCOR) is a method that determines the external level loss over a frequency range in advance, see [Figure 6-19](#).

The difference between the generator output level and the level at the DUT determines the correction value at the respective frequency. Alternatively, the attenuation characteristics over a certain frequency range of, for example, RF cables are also specified in the associated data sheet.

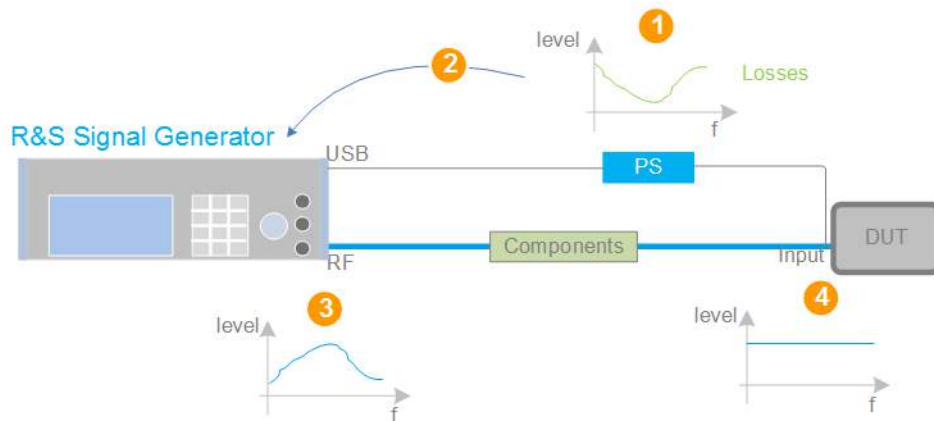

Figure 6-19: Understanding the principle of user correction

- | | |
|------------|---|
| DUT | = Device under test |
| Components | = Designation of all components between the measurement equipment and the DUT, e.g. cables |
| PS | = Power sensor, e.g. R&S NRP, connected at the DUT's input and the USB connector of the R&S SMBV100B |
| 1 | = Power sensor measures the level over a frequency range, where the collected values correspond to the losses caused by the components between the R&S SMBV100B and the DUT |
| 2 | = Obtain the correction data by inverting the collected data; load the correction parameters in the R&S SMBV100B |
| 3 | = In the R&S SMBV100B, the RF signal is pre-processed with the correction values so that the signal at the outputs is the inverted version of the external losses |
| 4 | = Received at the DUT input, the pre-processed signal is flat |

With active **UCOR**, the generator adds the correction value internally and thus increases the output level by exactly the amount of the loss between its output and the DUT. For frequencies which are not contained in the list, the level correction is calculated by interpolation of the closest correction values.

Possible ways for configuring the user correction values

You can configure correction values in the following ways:

- **Internally**

- Use the built-in table editor in the "UCOR > Edit User Correction Data" dialog. Once defined, user correction values can be saved in a file. Files with correction data can be exported, for example, to exchange configuration between instruments or to modify the file content with an external program and reload them again.
- Using the corresponding remote-control commands.

Note that you have to create a user correction file first.

- **Externally**
Create a file with correction values as a CSV file with Microsoft Excel, with a Notepad or a similar tool and save it with the predefined extension. Transfer the file to and load it into the instrument.

UCOR file format

Files containing correction data are simple files in text or comma-separated value (CSV) file format. The filename is user-definable; the file extension is *.ucor.

The file contains a list of correction values, one row per frequency and correction value pair; a new line indicator separates the correction values.

For file handling, use the standard functions in the "File Manager", see [Chapter 9.8, "Using the File Manager"](#), on page 462.

Collecting correction data

To fill the frequency and power values in the correction table, use one of the following options:

- **Manually**, row by row.
- Fill the table **automatically** with linearly interpolated values, calculated based on value range and step size.
- Acquire the real frequency response characteristics of the used component with the **R&S NRP power sensor**, see [Understanding the principle of user correction](#).

Using a power sensor for frequency response measurements

Consider the following when using R&S NRP power sensors to measure the correction values:

- Measure the level directly at the input of the DUT.
- Use the internal correction functions of an R&S NRP power sensor to increase the measurement accuracy.
- Use S-parameter to consider the impact of any two-port device like an adapter between the signal generator and the sensor input.



Interactions and characteristics

Active "User Correction" is effective in all operating modes.

The RF output level ($Level_{RF}$) is the sum of the level value and the correction for the particular frequency:

$$Level_{RF} = \text{"Status bar > Level"} + \text{"UCOR"}$$

Activated user correction is indicated by the status indication "UCOR" in the status bar.

6.12.3.1 User Correction Settings

Access:

1. Select "RF" > "RF Level" > "User Correction".
2. If you already have created a file with user correction data:
 - a) Select "UCOR Data > navigate to the file *.uco > Select".
 - b) Proceed with [step 4](#).
3. If you need to create a new file:
 - a) Select "UCOR Data > New".
 - b) Enter the filename `UCOR_Data` and confirm with "Ok".
 - c) Choose the file and confirm with "Select".
 - d) Select "Edit UCOR Data".
 - e) To fill the user correction data table, proceed as described in [Chapter 6.12.3, "User Correction"](#), on page 352.
4. Select block diagram > RF > "On".
5. Select "State > On".

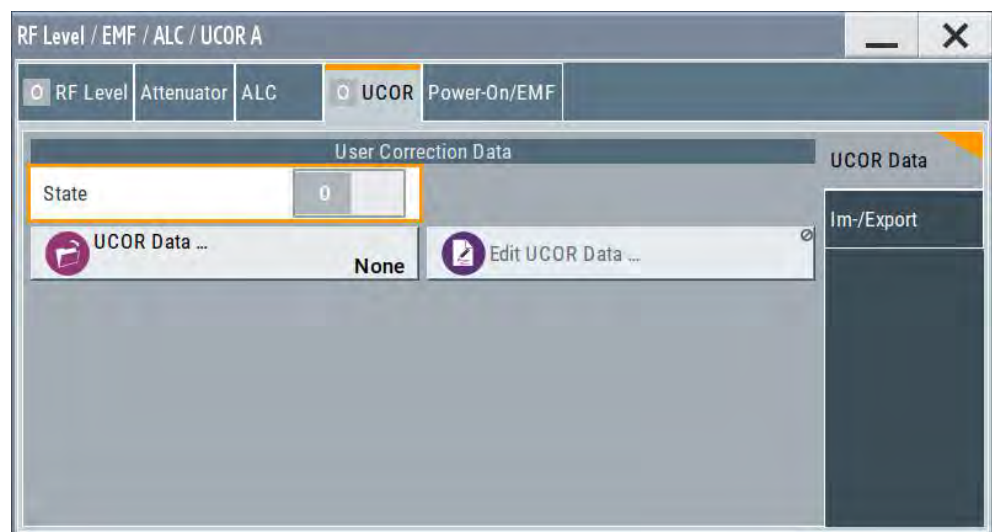

The "UCOR" dialog contains all settings for creating and handling files with user-defined level correction values.

The remote commands required to define these settings are described in [Chapter 12.16.5, "SOURCE:CORREction Subsystem"](#), on page 802.

Settings

State.....	356
User Correction.....	356
UCOR Data.....	356
Edit UCOR Data.....	356

State

Activates user correction.

Remote command:

[\[:SOURce<hw>\]:CORRection\[:STATe\]](#) on page 807

User Correction

Indicates the corrected level value for a specific frequency point.

Remote command:

[\[:SOURce<hw>\]:CORRection:VALue?](#) on page 806

UCOR Data

Accesses the standard "File Select" function of the instrument. The provided navigation possibilities in the dialog are self-explanatory.

Files with user correction values are files with predefined file extension *.uco. When a file is selected, the dialog indicates the filename.

You can create the file internally in the table editor or externally.

- To select an existing file, select "Select List > navigate to the file *.uco > Select"
- Use the general editor function to create internally new file or to edit an existing one.
- Use the standard file manager function to load externally created files to the instrument.

Remote command:

[\[:SOURce\]:CORRection:CSET:CATalog?](#) on page 807

[\[:SOURce<hw>\]:CORRection:CSET\[:SElect\]](#) on page 806

[\[:SOURce\]:CORRection:CSET:DElete](#) on page 808

Edit UCOR Data

Opens the build-in table editor to define a new correction table or edit an existing one.

See also:

- [Chapter 6.10.7, "List Editor"](#), on page 314
- ["Fill..."](#) on page 316
- [Chapter 6.12.3.3, "Fill with Sensor"](#), on page 360

6.12.3.2 List Editor

The "User Correction" and "List Mode" dialogs provide a build-in list editor for defining the corresponding value pairs.

The table and navigation functions of the UCOR and list mode editors have the same structure and are therefore summarized below. The access is specified for both modes, the fields and functions are explained using the example of the list mode.

Access to "Edit List Mode Data":

- ▶ "RF" > "Sweep/List" > "List Mode" > "List Mode Data" > "Edit List Mode Data"

	Frequency /Hz	Correction Value /dB
0	1 560 000 000.00	11.51
1	1 561 000 000.00	11.03
2	1 562 000 000.00	10.55
3	1 563 000 000.00	10.07
4	1 564 000 000.00	9.59
5	1 565 000 000.00	9.11
6	1 566 000 000.00	8.63
7	1 567 000 000.00	8.15
8	1 568 000 000.00	7.67
9	1 569 000 000.00	7.19
10	1 570 000 000.00	6.71
11	1 571 000 000.00	6.23

Go To Edit Fill with Sensor ... Save As ... Save

The editor for list mode data provides a table with RF frequency and power values and standard navigation functions.

Access to "Edit User Correction Data":

- ▶ "RF" > "RF Level" > "User Correction" > "Edit User Cor. Data"

	Frequency /Hz	Power /dBm	Dwell Time /s
0	1 000 000 000.000	-20.00	0.010 000
1	1 500 000 000.000	-25.00	0.010 000
2	3 000 000.000	-10.00	0.050 000
3	2 000 000 000.000	-30.00	0.100 000
4			

Go To Edit Save As ... Save

The editor for user correction provides a table with RF frequency and power values, an extra column for defining variable dwell times, and standard navigation functions.



All columns in a row must contain values. Cells with missing values are therefore filled automatically, using the value of the previous row.

If you use **global dwell time in list mode**, consider also that the instrument uses the value set with **Global Dwell Time** for all list steps and not the values from the list.

Since the table and navigation functions can be assumed to be known, the following description contains a brief overview, shown by the example of the "List Data Editor". If a function relates to a particular dialog, it is explicitly stated.

Settings

Edit List Mode Data.....	358
Data handling keys	358
L Go To.....	358
L Edit.....	359
L Fill with Sensor.....	359
L Save As/Save.....	359
Fill.....	359

Edit List Mode Data

Table with values for list or user correction processing.

Note: Once you enter a value, the editor automatically adds preset values in the other columns. This functionality protects against data loss, otherwise incomplete rows will be lost when saving. You can simply override these values.

"Frequency /Hz"

Sets the frequency values.

Remote command:

[:SOURce<hw>] :LIST:FREQuency on page 847

[:SOURce<hw>] :CORRection:CSET:DATA:FREQuency on page 805

"Power /dBm" Sets the level values.

Remote command:

[:SOURce<hw>] :LIST:POWer on page 848

[:SOURce<hw>] :CORRection:CSET:DATA:POWer on page 805

"Dwell /s" In list mode, sets the dwell time values.

Remote command:

[:SOURce<hw>] :LIST:DWELL:LIST on page 846

Data handling keys

Standard functions for file and data handling.

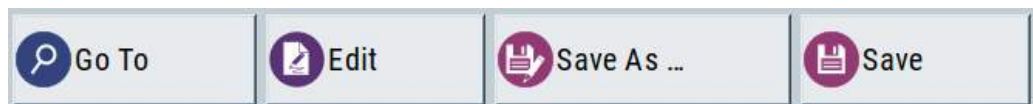

Go To ← Data handling keys

Selects a row for editing.

Edit ← Data handling keys

Enables you to insert, or delete a row or ranges within a list, and provides access to a dialog for automatic filling, see " Fill... " on page 316.

Fill with Sensor ← Data handling keys

Opens a dialog to configure the automatic filling of user correction data with an R&S NRP power sensor. Available in UCOR mode only.

See [Chapter 6.12.3.3, "Fill with Sensor"](#), on page 360

Save As/Save ← Data handling keys

Stores the list in a file with user-defined name and predefined file extension. To save a copy or create a file, use the "Save as" function.

Fill...

Provides parameters for filling a table automatically with user-defined values.

From 0	Range 1
Column To Fill Frequency/Hz	
Start Value 2.000 000 000 000 GHz	End Value 2.000 000 000 000 GHz
Increment Value 200.000 000 000 MHz	
<input checked="" type="checkbox"/> Fill	

To fill the table, select "Fill".

Note: Once you enter a value or fill a column, the editor automatically adds preset values in the other columns. This functionality protects against data loss, otherwise incomplete rows will be lost when saving. You can simply override these values.

"From / Range"

Defines the start line and number of lines to be filled.

"Column To Fill"

Selects, if the column is filled up with frequencies in Hz, levels in dBm or dwell times in s.

"Start Value / End Value"

Sets the start value for frequency, level or dwell time. The end value is read only and depends on the increment value and the range.

"Increment Value"

Determines the step size.

"Fill"

Fills the column specified in "Column To fill".

6.12.3.3 Fill with Sensor

Access:

1. Select "RF" > "RF Level" > "User Correction".
2. Select "UCOR Data > navigate to the file *.ucor > Select".
3. Select "Edit UCOR Data > Fill With Sensor...".

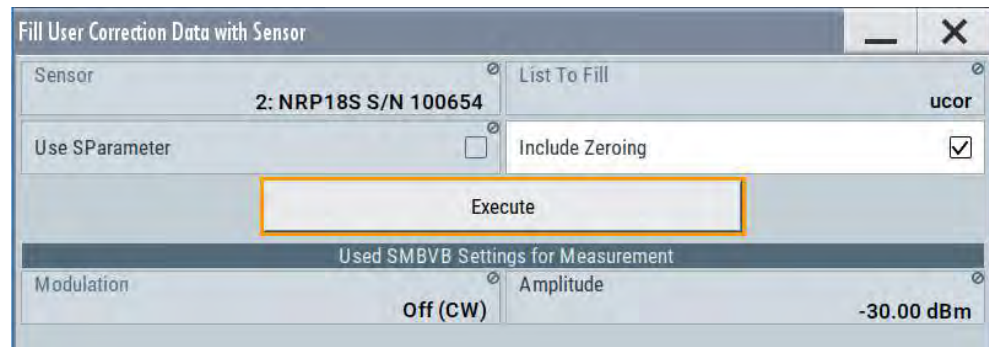

This dialog contains parameters for filling a table automatically with sensor readings.



To fill the table, select "Execute".

For information on power sensors and how to use them, see [Chapter 6.12.5, "How to Calibrate the Power Level with an R&S NRP Power Sensor"](#), on page 374.

Settings

Fill User Correction Data with Sensor	360
Used SMBV100B Settings For Measurement	361

Fill User Correction Data with Sensor

- "Sensor"
Displays connected sensors for selection.
- "List To Fill"
Indicates the used list.
- "Use SParameter"
Indicates whether SParameter correction in the R&S NRP power sensor is used.
- "Include Zeroing"
Performs a zeroing procedure before acquiring the user correction data to improve precision.
No signal is applied to the sensor during zeroing. RF output is temporarily switched off during that time.
When unchecked, the zeroing procedure is skipped. However, the RF signal level might be blanked shortly. This setting is useful if blanking of RF is undesirable or the absence of power at the sensor cannot be guaranteed.
- "Execute"

The "Execute" button is only enabled if a sensor is detected and the user correction list contains at least one frequency value.

Remote command:

`[:SOURce<hw>] :CORRection:ZERoing:STATe` on page 807

`[:SOURce<hw>] :CORRection:CSET:DATA [:SENSor<ch>] [:POWer] :SONCe`
on page 806

Used SMBV100B Settings For Measurement

Displays the settings relevant for the measurement.

"Modulation" Indicates the modulation state

"Amplitude" Shows the currently set level.

Remote command:

n.a.

6.12.3.4 Import/Export List Files

Access:

- Select one of the following:
 - "RF" > "Sweep/List" > "List mode".
 - "RF" > "RF Level" > "User Correction".
- Select "Import/Export".

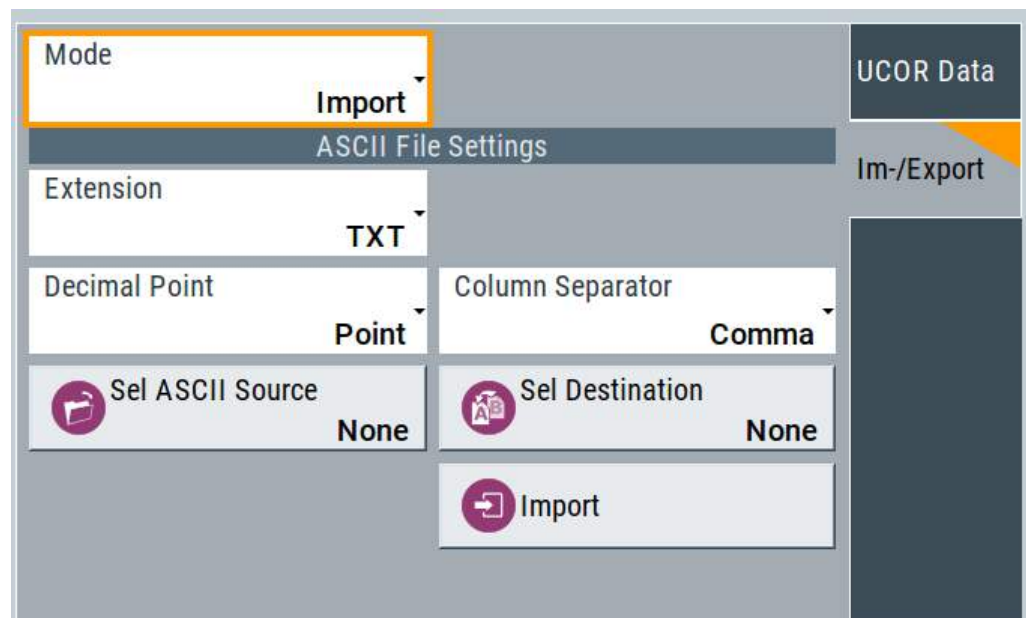

Figure 6-20: Im-/Export dialog (example with UCOR settings)

The "Import/Export" dialog contains all functions and settings to import externally created list data or to export it accordingly. You can process and store a list in the formats *.txt (ASCII), or *.csv (plain text with identical sequence of fields). The table separators and the decimal floating point numbers are customizable.

Settings

Mode	362
ASCII File Settings.....	362
Select (ASCII) Source/Select (ASCII) Destination.....	362
Select Source/Select ASCII Destination.....	363
Import / Export.....	363

Mode

Selects import or export of a data list file. The provided parameters vary according to the selected mode.

Remote command:

[:SOURce<hw>] :LIST:DEXChange:MODE on page 855

[:SOURce<hw>] :CORRection:DEXChange:MODE on page 810

ASCII File Settings

Defines the format and the separators of the associated data file.

"Extension" Selects *.csv or *.txt format.

"Decimal" Sets "Point" (dot) or "Comma" as the decimal separator used in the ASCII data with floating-point numerals.

"Column Separator" Sets the separator between the columns in an ASCII table.
Available are: "Tab", "Semicolon", "Comma" or "Space".

Remote command:

[:SOURce<hw>] :LIST:DEXChange:AFIle:EXTension on page 854

[:SOURce<hw>] :LIST:DEXChange:AFIle:SEParator:DECimal on page 854

[:SOURce<hw>] :LIST:DEXChange:AFIle:SEParator:COLumn on page 854

[:SOURce<hw>] :CORRection:DEXChange:AFIle:EXTension on page 808

[:SOURce<hw>] :CORRection:DEXChange:AFIle:SEParator:DECimal
on page 809

[:SOURce<hw>] :CORRection:DEXChange:AFIle:SEParator:COLumn
on page 809

Select (ASCII) Source/Select (ASCII) Destination

In "Mode > Import", access the file select dialog that provides standard file handling functions.

Where:

- "Select ASCII Source": defines the file to be loaded (imported)
- "Select ASCII Destination": selects the filename under that the loaded file is saved

Remote command:

[:SOURce<hw>] :LIST:DEXChange:AFIle:CATalog? on page 853

[:SOURce<hw>] :LIST:DEXChange:AFIle:SElect on page 854

`[:SOURce<hw>] :CORRection:DEXChange:AFILe:CATalog?` on page 808

`[:SOURce<hw>] :CORRection:DEXChange:AFILe:SElect` on page 809

Select Source/Select ASCII Destination

In "Mode > Export", access the file select dialog that provides standard file handling functions.

Where:

- "Select Source": selects the file to be exported
- "Select ASCII Destination": defines the filename and the file path for the exported file

Remote command:

`[:SOURce<hw>] :LIST:DEXChange:SElect` on page 855

`[:SOURce<hw>] :CORRection:DEXChange:SElect` on page 810

Import / Export

Imports or exports the selected data list file, depending on the current mode.

Remote command:

`[:SOURce<hw>] :LIST:DEXChange:EXECute` on page 853

`[:SOURce<hw>] :CORRection:DEXChange:EXECute` on page 809

6.12.4 Using Power Sensors

The R&S SMBV100B works with most of the R&S NRP power sensors and thus supports various application tasks. Using power sensors, you can for example determine attenuation characteristics of downstream equipment or cables. You can use the measured values to compensate the losses with internal control functions or with an external control circuit in real time.

R&S NRP sensors are highly accurate standalone measuring devices, suitable for a wide range of applications. The devices communicate directly with the signal generator, calculate the average or peak power internally, include S-parameter correction and return the measurement results to the generator.

The R&S SMBV100B works with any sensor of the R&S NRP series and can perform up to four power measurements simultaneously.



Check the firmware version of the R&S NRP sensors regularly. Update the firmware, if necessary.

For updates, see the Rohde & Schwarz website <http://www.rohde-schwarz.com> in section "Power Meters & Voltmeters".

You can perform the following functions when working with power sensors:

- [Chapter 6.12.4.1, "Connecting R&S NRP Power Sensors to the R&S SMBV100B"](#), on page 364
Overview on the supported connectors, connection options and the required accessories.
- [Chapter 6.12.4.2, "NRP Sensor Mapping"](#), on page 365

Shows all R&S NRP sensors connected to the instrument, or in the LAN.

- [Chapter 6.12.4.3, "NRP Power Viewer"](#), on page 366
A function for measuring and monitoring the RF output power or a user-defined signal source.
- [Connecting R&S NRP Power Sensors to the R&S SMBV100B](#).....364
- [NRP Sensor Mapping](#)..... 365
- [NRP Power Viewer](#)..... 366

6.12.4.1 Connecting R&S NRP Power Sensors to the R&S SMBV100B

R&S NRP sensors are connected to the R&S SMBV100B in the following ways:

- Connection to the Sensor connector
 - R&S NRP-ZK6 (six-pole interface cable) for R&S NRPxx power sensors
 - No additional cable for R&S NRP-Zxx power sensors (cable is fixed on the sensor)
- Connection to the USB connector
Requires the following cables, depending on the used sensor type:
 - R&S NRP-ZKU (USB interface cable) for R&S NRPxx power sensors
 - R&S NRP-Z3 or R&S NRP-Z4 (USB adapter cables) for sensors of the R&S NRP-Zxx family
- Connection via R&S NRP-Z5 sensor hub
The R&S NRP-Z5 USB sensor hub (high-speed USB 2.0) can host up to 4 R&S NRP sensors. It provides simultaneous internal and external triggering of all connected sensors.
Requires additional cables, depending on the used output connector of the hub. Choose one of the following:
 - Short extension cable R&S NRP-Z2 for connection to the sensor connector. This six-pole connection provides the external trigger capability.
 - Standard USB cable (USB type A to USB type B) to any USB type A connector of the R&S SMBV100B. This connection does not support external triggering.
- Connection via USB hub with external power supply unit
Requires the following cables, depending on the used sensor type:
 - R&S NRP-ZKU (USB interface cable) for R&S NRPxx power sensors
 - R&S NRP-Z3 or R&S NRP-Z4 (USB adapter cables) for sensors of the R&S NRP-Zxx family
- Connection via LAN for R&S NRPxxxSN power sensors
Using the Ethernet interface requires PoE (Power over Ethernet) to provide the electrical power.
To establish the connection, you can use:
 - A PoE Ethernet switch, e.g. R&S NRP-ZAP1 and an RJ-45 Ethernet cable.
 - A PoE injector and an RJ-45 Ethernet cable.

For details, see the description [R&S®NRP®Series Power Sensors Getting Started](#).

Detection and mapping

The R&S SMBV100B automatically detects a connected R&S NRP power sensor and indicates it in the "NRP Power Viewer" and "NRP Sensor Mapping" dialogs.

By default, detected sensors are indicated as follows:

- A sensor connected at the Sensor socket is assigned as "Sensor 1".
If no sensor is connected to this socket, channel 1 remains unassigned.
- Sensors 2 to 4 are assigned to the sensors at the USB connectors, according to their sequence of connection.

You can change the default mapping in the [NRP Sensor Mapping](#) dialog.



On connection, the R&S SMBV100B immediately starts the measurement of a detected R&S NRP power sensor. If you perform an instrument preset ([Preset] key or *RST), the R&S SMBV100B stops the measurements. The connection and the mapping of the power sensors remain, the measurements must be restarted.

6.12.4.2 NRP Sensor Mapping

The "NRP Sensor Mapping" lists all R&S NRP sensors detected by the instrument.

Any R&S NRP sensor that supports the USB legacy protocol and is connected to one of the USB interfaces, is detected automatically and added to the list. Vice versa, the R&S SMBV100B removes a sensor from the list, when it is disconnected.

R&S NRP sensors that are connected via LAN or use the USBTMC protocol are not automatically detected. They are detected by the scan search function.

Access:

- ▶ Select "RF" > "RF Measurement" > "NRP Sensor Mapping".

	Sensor Name	Protocol	Connector	Mapping
1	NRP18S-100654	Legacy		1
2				
3				
4				
5				

Scan
 Start

The dialog lists all detected R&S NRP sensors for selection and mapping. You can also browse the network for sensors.

The detected sensors are characterized by the used protocol and the corresponding connector icon. In the "Mapping" column, you can assign the sensor to one of the available sensor channels. The list can contain several entries but the R&S SMBV100B can only use up to four sensors simultaneously.

The remote commands required to define these settings are described in [Chapter 12.14, "SENSe, READ, INITiate and SLISt Subsystems"](#), on page 620.

Settings

Sensor Mapping List	366
Scan	366

Sensor Mapping List

Displays a list of all sensor entries with information on the sensor name, the used protocol, the connector and the assigned mapping.

If a sensor is connected via LAN or uses the USBTMC protocol, its protocol is indicated as "Visa".

Remote command:

`:SLISt[:LIST]?` on page 623

`:SLISt:ELEMent<ch>:MAPPing` on page 623

`:SLISt:SENSor:MAP` on page 624

Scan

Scans the network and the USB connections for sensors connected via the VISA communication protocol, i.e. sensors that are addressed via LAN or USBTMC.

Sensors communicating via the USB legacy protocol are detected automatically.

Remote command:

`:SLISt:SCAN[:STATe]` on page 623

6.12.4.3 NRP Power Viewer

The R&S SMBV100B features the power viewer function for measuring or monitoring signals with R&S NRP power sensors.

The R&S SMBV100B can perform up to four power measurements simultaneously. The measured signals can be the RF output power or other selected signal sources.

About

The R&S SMBV100B can perform up to four power measurements simultaneously.

Depending on the signal characteristic (CW, AM, pulsed, etc.) or the parameter to be measured (average, peak, etc...) a suitable R&S power sensor must be used.

About the measuring principle, averaging filter, filter length, and achieving stable results

A sensor measures the average or peak RF power of the source continuously. The measurement results are displayed in the "NRP Power Viewer" dialog.

The power viewer function uses **averaging filters** for getting a stable readout.

Measurement results could be interfered for instance by too much noise in your setup, by a bad suppression of harmonics or non harmonics or when you reach the sensitivity level of your power sensor.

Measurements are continuously repeated in a predefined time window. The measurement result is obtained by averaging the measured values for the last $2N$ time windows. This approach is referred to as a **two-step averaging process**.

The factor of 2 in the formula arises because the output signals from the microwave detector are chopped at the same rate as the time windows to suppress low-frequency noise. An independent measured value can only be obtained from two consecutive values.

The variable N in the formula indicates the **filter length**. The filter length then directly influences the measurement time. The filter length can be selected automatically or it can be manually set to a fixed value.

Depending on the R&S NRP power sensor type, the manual setting of the filter length varies in resolution:

- Resolution = 1 for the R&S NRPxx power sensor family
- Resolution = 2^n for R&S NRP-Zxx power sensors, with $n = 1$ to 16

Follow the following general recommendation to find out the **optimum filter length**:

- Always start a measurement in auto mode ("Filter > Auto").
Check if the measurement results are sufficient.
- If the power is not constant, select the filter length manually ("Filter > User").
Trigger the "Auto Once" function to search for the optimum filter length for the current measurement conditions.
The estimated value is indicated as filter length.
- If the target measurement accuracy value is known, select "Filter > Fixed Noise".
The averaging factor is selected automatically and so that the sensor's intrinsic noise (two standard deviations) does not exceed the specified noise content.
- Different sensor types achieve the same filtering result with different filter and time window lengths.

The time window length depends on the sensor type:

- For most sensors, it is fixed to 20 ms.
- For the R&S NRP-Z81 sensor, it is 10 μ s.
The R&S NRP-Z81 uses filter length that is 1000 times larger than the filter length for other sensors.

About zeroing

Activates the auto zero function.

Zeroing calibrates the external power sensor by adjusting its reading at zero signal power. For this purpose, the RF power source must be switched off or disconnected from the sensor. If a Rohde & Schwarz power sensor receives an input power during the zeroing process, it aborts zeroing and generates an error message. Zeroing takes a few seconds, depending on the sensor model. Refer to the documentation of your power sensor for more information.

Tips for zeroing

When to perform zeroing:

- During warm up after switching on or connecting the instrument
- After a substantial change of the ambient temperature
- After fastening the power sensor module to an RF connector at high temperature
- After several hours of operation
- When low-power signals are to be measured, e.g. less than 10 dB above the lower measurement limit.
- Switch off the RF power source for zeroing, but do not disconnect it from the power sensor. This proceeding keeps the thermal equilibrium, and the zeroing process also compensates the noise that superimposes the measured signal (e.g. from a broadband amplifier).

Related settings and functions

- Measurements-related settings, like results, filter, filter length:
[NRP Power Viewer Settings](#)
- Software version of the connected power sensor:
`:SENSe<ch>[:POWER]:TYPE?` on page 632
- Assignment of the external signals and the output connectors:
[Chapter 10.2.4, "RF Connectors Settings"](#), on page 490
- Acquisition of level correction data:
[Chapter 6.12.3, "User Correction"](#), on page 352.

Additional information

See Rohde & Schwarz website <http://www.rohde-schwarz.com> in section "Power Meters & Voltmeters" for:

- R&S NRP power sensor manual.
- Information on the R&S NRP-Z5 sensor hub and the available accessories.
- Sensor software updates.

NRP Power Viewer Settings

Access:

- ▶ Select "RF" > "RF Measurement" > "NRP Power Viewer".

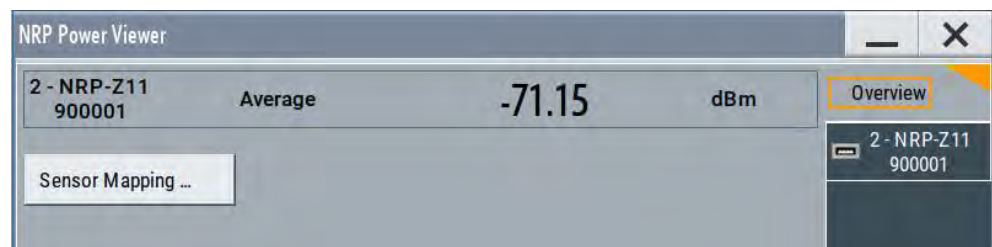

The "Overview" tab shows the list of detected sensors, and provides a separate tab per sensor.

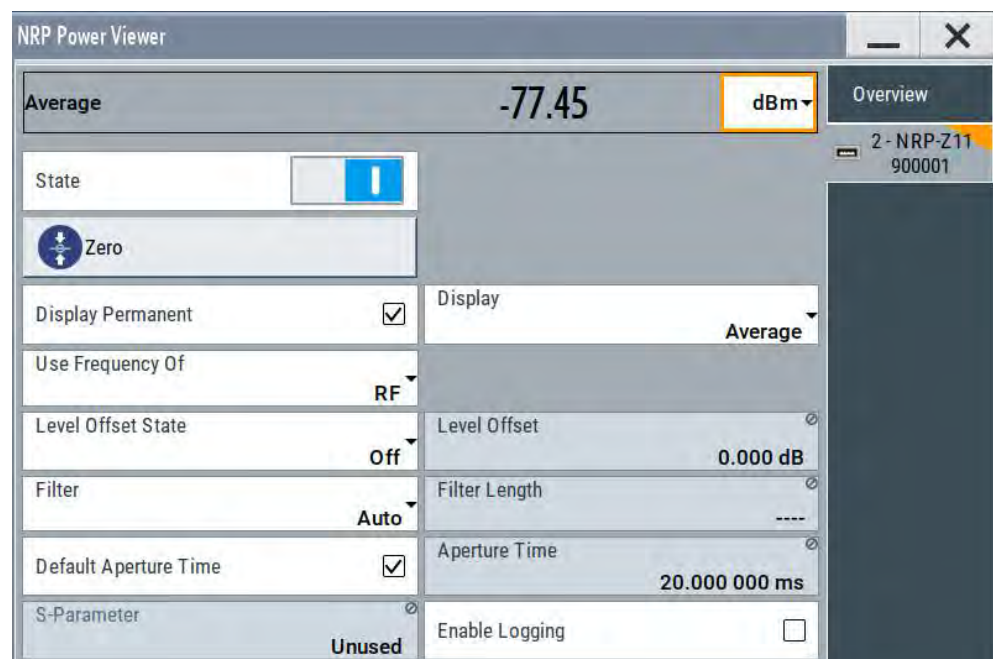

A sensor tab contains all parameters for configuring the sensor settings, like average or peak display, reference source, filter and level offset.

The remote commands required to define these settings are described in [Chapter 12.14, "SENSE, READ, INITiate and SLISt Subsystems"](#), on page 620, including the triggering of the measurement and the retrieval of measurement results.

Settings:

Sensor type and serial number	370
Level (Peak) / Level (Average)	370
Sensor Mapping.....	370
Sensor Settings.....	370
L State	370
L Zero	370
L Display.....	370
L Permanent	371
L Use Frequency Of.....	371
L Frequency	371
L Level Offset State,Level Offset.....	371
L Filter.....	371

L Filter Length.....	372
L Auto Once.....	372
L Noise/Signal Ratio.....	372
L Timeout.....	372
L Default Aperture Time.....	373
L Aperture Time.....	373
L S-Parameter	373
L Enable Logging.....	373

Sensor type and serial number

Indicates the type and the serial number of the selected R&S NRP power sensor, and the channel the sensor is assigned to.

The displayed [Level \(Peak\)](#) / [Level \(Average\)](#) values correspond to the particular sensor.

Remote command:

[:SENSe<ch>\[:POWer\]:TYPE?](#) on page 632

[:SENSe<ch>\[:POWer\]:SNUMber?](#) on page 631

Level (Peak) / Level (Average)

Indicates the measured peak or average level value.

You can also change the unit for the results display: Watt, dBm or dBμV.

Note: Peak level measurements are provided if the power sensor supports this feature.

Remote command:

[:READ<ch>\[:POWer\]?](#) on page 624

[:SENSe<ch>:UNIT\[:POWer\]](#) on page 625

Sensor Mapping

Accesses the [NRP Sensor Mapping](#) dialog.

Sensor Settings

One tab per sensor provides the corresponding setting parameters.

State ← Sensor Settings

Activates level measurement.

Remote command:

[:INITiate<hw>\[:POWer\]:CONTinuous](#) on page 624

To query the availability of a sensor at a given connector, use the command :

[:SENSe<ch>\[:POWer\]:STATus\[:DEVice\]?](#) on page 632.

Zero ← Sensor Settings

Activates the auto zeroing.

For details, see "[About zeroing](#)" on page 367.

Remote command:

[:SENSe<ch>\[:POWer\]:ZERO](#) on page 633

Display ← Sensor Settings

Sets the display mode for power readings.

Permanent ← Display ← Sensor Settings

Activates the permanent indication of the power measurement result in the task bar.

The instrument shows the type of sensor, the used connector, the measurement source and, if set, the offset.

You can activate the permanent display for several sensors.

Remote command:

`:SENSe<ch>[:POWer]:DISPlay:PERManent:STATe` on page 627

Use Frequency Of ← Sensor Settings

Selects the source for measurement.

- | | |
|--------|--|
| "RF" | The R&S SMBV100B transfers the RF frequency and level settings to the R&S power sensor automatically. Thus you achieve power readings of high accuracy, irrespective from the connected sensor type. |
| "User" | Sets a user defined frequency. |

Example:

If you have a frequency converting device between the generator and the DUT. If the frequency converter doubles the frequency, you can set twice the frequency in the R&S SMBV100B. The R&S power sensor considers this RF frequency setting.

Set the parameter [Frequency](#) to the measurement's frequency.

Remote command:

`:SENSe<ch>[:POWer]:SOURce` on page 632

Frequency ← Sensor Settings

Defines the frequency value if "Source > User" is used.

Remote command:

`:SENSe<ch>[:POWer]:FREQuency` on page 630

Level Offset State,Level Offset ← Sensor Settings

Activates and defines a level offset which is considered in the power measurement result. The level offset value is always expressed in dB, irrespective of the display of the measurement result.

This function allows you to consider, for example, an attenuator in the signal path.

Remote command:

`:SENSe<ch>[:POWer]:OFFSet` on page 631
`:SENSe<ch>[:POWer]:OFFSet:STATe` on page 631

Filter ← Sensor Settings

Selects the way the length of the used filter is defined.

See also "[About the measuring principle, averaging filter, filter length, and achieving stable results](#)" on page 367.

"Auto"	Selects the filter length automatically and adjusts it to the measured value. The value is indicated with the parameter Filter Length . When high output power is applied, the filter length and therefore the measurement time can be short. When low output power is applied, the filter length and therefore the measurement time is increased which reduces the considered noise content in your measurement.
"User"	The filter length is defined manually, with the parameter Filter Length . As the filter length works as a multiplier for the time window, constant filter length results in a constant measurement time. Values 1 and 2N are allowed.
"Fixed Noise"	The averaging factor is taken automatically in accordance to the value Noise/Signal Ratio . Thus, the sensor's intrinsic noise (2 standard deviations) does not exceed the specified noise content. To avoid long measurement times when the power is too low, set a Timeout . Timeout is the maximum acceptable measurement time which limits the averaging factor and therefore leads to a more unstable readout.

Remote command:

`:SENSe<ch>[:POWer]:FILTer:TYPE` on page 629

Filter Length ← Sensor Settings

Sets or indicates the filter length, depending on the selected filter mode.

- "Filter > Auto" indicates the automatically adjusted filter length.
- "Filter > User" enables you to set the filter length manually.
- "Filter > Fixed Noise" hides the setting parameter.

Remote command:

`:SENSe<ch>[:POWer]:FILTer:LENGth:AUTO?` on page 627

`:SENSe<ch>[:POWer]:FILTer:LENGth[:USER]` on page 628

Auto Once ← Sensor Settings

Searches the optimum filter length for the current measurement conditions. The result is indicated with the parameter [Filter Length](#).

See also "[About the measuring principle, averaging filter, filter length, and achieving stable results](#)" on page 367.

Remote command:

`:SENSe<ch>[:POWer]:FILTer:SONCe` on page 629

Noise/Signal Ratio ← Sensor Settings

For [Filter > Fixed Noise](#), sets the noise content.

Remote command:

`:SENSe<ch>[:POWer]:FILTer:NSRatio` on page 628

Timeout ← Sensor Settings

For "Filter > Fixed Noise", sets a time limit for the averaging process.

Remote command:

`:SENSe<ch>[:POWer]:FILTer:NSRatio:MTIME` on page 629

Default Aperture Time ← Sensor Settings

The sensor default setting is sufficient. Disable this parameter to specify a user-defined aperture time per sensor, if, for example, the readings vary.

To obtain stable readings, set the [Aperture Time](#) exactly to one modulation period.

Remote command:

```
:SENSe<ch>[:POWer]:APERTure:DEFault:STATe on page 625
```

Aperture Time ← Sensor Settings

If "Use Default Aperture Time > Off", defines the acquisition time per sensor.

For example, to obtain a sufficient low average value, set the aperture time exactly to one modulation period.

Remote command:

```
:SENSe<ch>[:POWer]:APERTure:TIME on page 626
```

S-Parameter ← Sensor Settings

Lists the S-Parameter correction data files retrieved for the connected power sensor. To activate the correction data, select the corresponding file.

S-Parameter correction is used to mathematically shift the reference plane to the DUT by considering the S-parameters for any components connected upstream of the sensor.

The S-Parameter table can be changed with the S-Parameters tool, provided as part of the free R&S NRP Toolkit software. For more information, refer to the manual of the connected R&S NRP power sensor.

Remote command:

```
:SENSe<ch>[:POWer]:CORRection:SPDevice:STATe on page 626
```

```
:SENSe<ch>[:POWer]:CORRection:SPDevice:LIST? on page 627
```

```
:SENSe<ch>[:POWer]:CORRection:SPDevice:SELeCt on page 626
```

Enable Logging ← Sensor Settings

Activates recording of R&S NRP power sensor readings in a log file.

There is 1 log file per sensor. The log files are created automatically and filled in continuously. They are text files with predefined filename `SensLog<n>.txt`, where `<n>` indicates the connected sensor. Log files are stored on the internal memory, in the directory `/var/user/SensorLogging`.

Each log file contains the measured value (2 readings when you work with peak sensors), the sensor type, and the measurement time (timestamp). Logged data is not overwritten. When a new measurement is started, the collected logging data is appended in the log file.

Check the used disc space regularly and remove log files to maintain storage capacity.

Note: The logging function is intended for measurements with long time intervals. It is suitable source for data reconstructions if the connection to the sensor was interrupted.

Remote command:

```
:SENSe<ch>[:POWer]:LOGGing:STATe on page 630
```

6.12.5 How to Calibrate the Power Level with an R&S NRP Power Sensor

Using a R&S NRP power sensor and the user correction function of the instrument, you can compensate external frequency responses. The R&S SMBV100B utilizes the readings of the power sensor and creates a correction value table for controlling the output level during operation.

To connect the R&S NRP to the R&S SMBV100B

1. Connect the power sensor.
See [Chapter 6.12.4.1, "Connecting R&S NRP Power Sensors to the R&S SMBV100B"](#), on page 364.
2. Select "RF" > "RF Measurement" > "NRP Sensor Mapping".
3. If the sensor is not detected automatically, select "Scan > Start".
The instrument scans the network and the USB connections for connected sensors and lists all detected R&S NRP sensors in the mapping table.
4. In the "Mapping" column, assign the sensor to a sensor channel (see [Chapter 6.12.4.2, "NRP Sensor Mapping"](#), on page 365).
5. Close the dialog.

To configure and calibrate the R&S NRP in the R&S SMBV100B

Provided the power sensor is connected to the R&S SMBV100B and is assigned to a sensor channel, we recommend that you calibrate and configure the power sensor in the "NRP Power Viewer" dialog.

1. In the block diagram > RF, turn off the RF output signal.
2. Select "RF" > "RF Measurement" > "NRP Power Viewer".

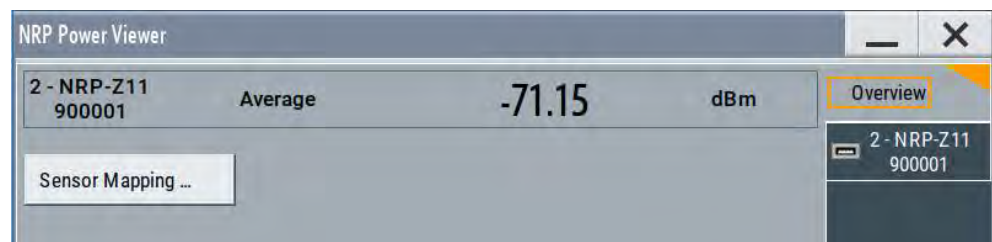

3. If the R&S SMBV100B has detected several connected power sensors, select the tab of the sensor you want to use.
4. Select "Zero" to start zeroing of the sensor.
Note: Always turn the RF power off or disconnect the sensor from RF before zeroing, since the function calibrates the power sensor at zero signal power.
The zeroing process takes a few seconds, depending on the power sensor type.
5. Configure additional parameters for the selected sensor as required.
6. Select "State > On".

7. Close the dialog.

To create user correction data with an R&S NRP and the R&S SMBV100B

We assume, that the power sensor is connected, assigned and ready for operation.

1. Select "RF" > "RF Level" > "User Correction".

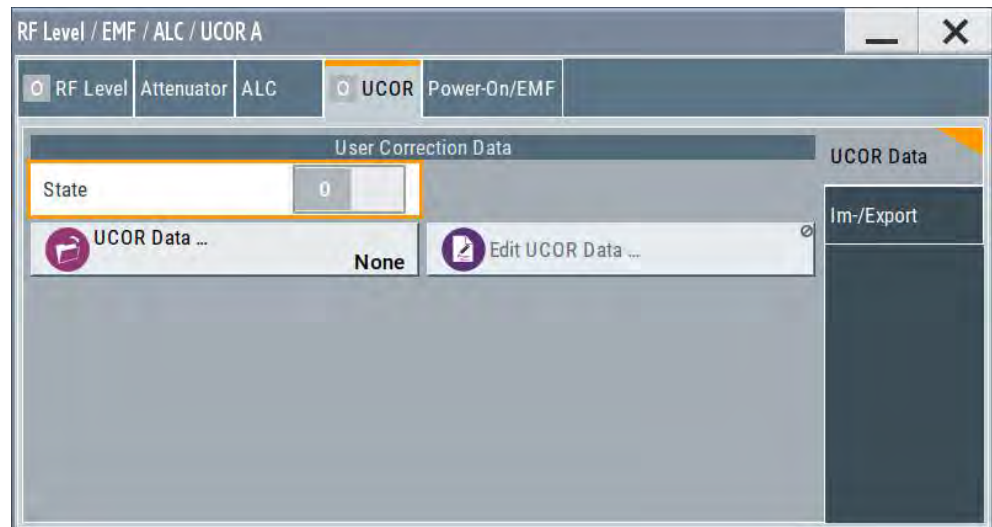

2. Select "UCOR Data > UCOR Data...".
3. Create a file: "New > Filename" and confirm with "OK".
4. Select the new file with "Select".
5. Select "Edit UCOR Data...".
6. Select "Edit > Fill".

The "Fill Table" dialog enables you to fill in the values of the columns automatically.
7. To fill in the frequency column:

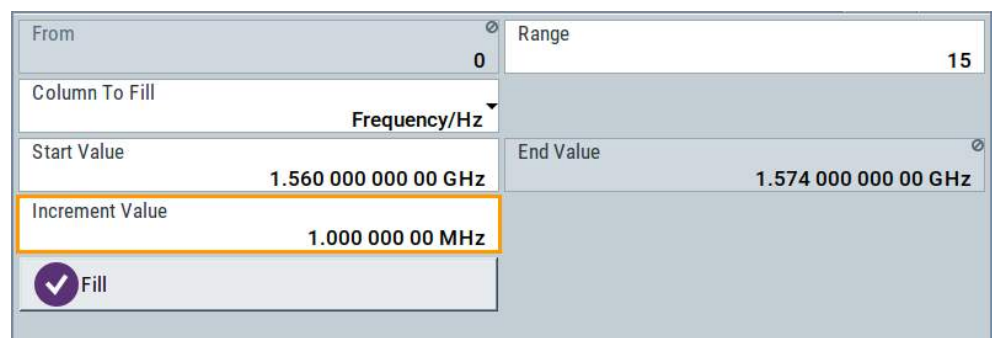

- a) Select "Select Column To Fill > Frequency / Hz".
- b) Select "Range > e.g. 15" to determine the number of values.
- c) Select "Start Value > e.g. 1.56 GHz".
- d) Select "Increment Value > e.g. 1 MHz", to determine the frequency steps.
- e) Select "Fill", to insert the frequency values.

The "Fill" function also fills the column of the "Correction Value / dB" values with a predefined value, since empty cells lead to the data loss of the entire line. If you need different values, you can change them manually, or you can use the automatic function "Fill with Sensor" as described in the next steps.

8. Select "Fill with Sensor".

The "Fill User Correction Data With Sensor" dialog provides an overview of the sensor configuration.

9. Select "Execute".

The R&S SMBV100B successively sets each frequency point, reads the measured power of the sensor and fills in the value in the correction table.

	Frequency /Hz	Correction Value /dB
0	1 560 000 000.00	11.51
1	1 561 000 000.00	11.03
2	1 562 000 000.00	10.55
3	1 563 000 000.00	10.07
4	1 564 000 000.00	9.59
5	1 565 000 000.00	9.11
6	1 566 000 000.00	8.63
7	1 567 000 000.00	8.15
8	1 568 000 000.00	7.67
9	1 569 000 000.00	7.19
10	1 570 000 000.00	6.71
11	1 571 000 000.00	6.23

Below the table is a toolbar with the following buttons: "Go To", "Edit" (highlighted with a red box), "Fill with Sensor ...", "Save As ...", and "Save".

10. Select "Save" to save the data in the file.

11. Close the dialog.

To perform power leveling calibration with user correction data

We assume that a user correction file is available in the user directory of the R&S SMBV100B or on a memory stick or in a shared directory.

If you have created and saved the file immediately before this step, the file is loaded in the "User Correction" dialog automatically. Otherwise you can load a previously saved file.

1. Select "RF" > "RF Level" > "User Correction".
2. Select "UCOR Data > UCOR Data...", if there is no file loaded already.
3. Select the directory and file you want to use.

4. Load the file with "Select".
5. To view the file content, select "Edit UCOR Data".
6. Select "UCOR Data > State > On" to apply the user correction values.

When you activate the RF output, the R&S SMBV100B considers the user correction data and adjusts the signal level accordingly to compensate external frequency responses.

7 Monitoring Signal Characteristics

The R&S SMBV100B is a highly configurable signal generator with level settings distributed over several dialogs. To optimize the signal generation process and to help monitoring the variation of the signal parameters through the instrument, the R&S SMBV100B is equipped with a real time graphical signal display. This section explains the provided functions for monitoring of the signal characteristics in real time. Here you can also find out how to visualize the generated signal with measurement diagrams.

7.1 Displaying Baseband Signal Characteristics in Real-Time

In test setups, you usually use signal and spectrum analyzers or an oscilloscope to display and analyze the characteristics of the generated signal. In the R&S SMBV100B, you can also use the built-in graphical signal display function and visualize a subset of signal characteristics.

7.1.1 Required Options

The minimum equipment layout for using this function includes the base unit.

7.1.2 About the Graphical Signal Display

To ease the setting and routing of baseband signals, R&S SMBV100B is able to capture these signals and display them graphically in different ways: as I/Q, vector, eye or constellation diagram, as power spectrum or as statistical evaluations.

In the digital domain, the measurements are based on recorded I/Q samples. The sources of these samples are selectable points (acquisition points) in the signal flow. You can configure and display the signal characteristics simultaneously in up to diagrams.

7.1.2.1 Available Diagrams

This section focuses on graphical signal displays, their content and application. See [Table 7-1](#) for an overview of the signal characteristics you can monitor.

Table 7-1: Graphics modes overview

Graphics modes	Domain	Measurement is known from this instrument
I/Q Diagram	Time	Oscilloscope (standard mode)
Vector Diagram	Time	Oscilloscope (XY mode)

Graphics modes	Domain	Measurement is known from this instrument
Constellation Diagram	Time	Oscilloscope (XY mode)
Eye Diagram	Time	Oscilloscope (triggered to symbol clock and showing repetitive traces)
CCDF Display	Statistical representation of peaks	Peak Power Analyzer
Power Spectrum	Frequency	Spectrum Analyzer

I/Q Diagram

The I/Q diagram displays the inphase component ($i[t]$) and quadrature component ($q[t]$) of the I/Q signal over time.

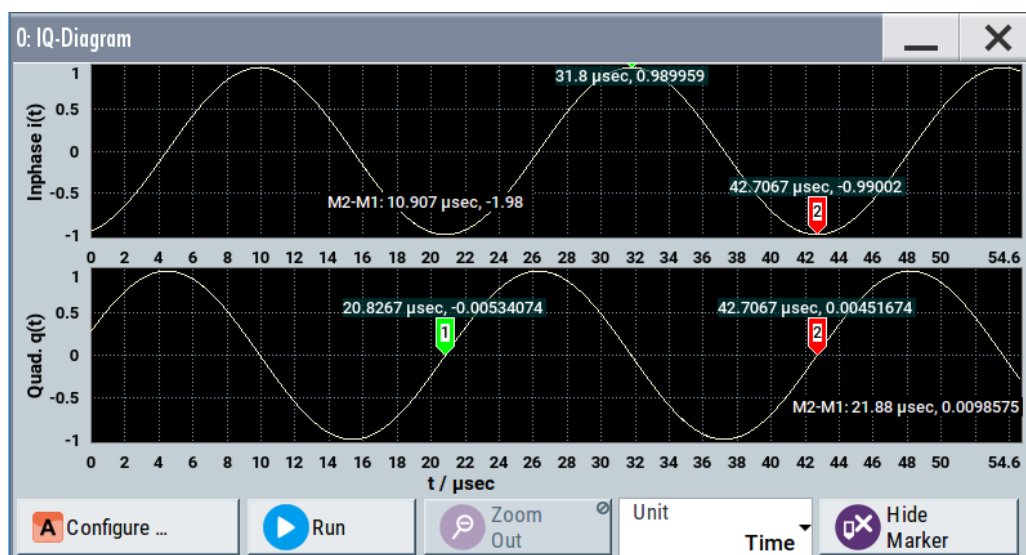

Figure 7-1: I/Q diagram with markers

= window with two separate coordinate systems with identical X and Y axes

X-axis = time represented as number of symbols, chips, or samples depending on the signal

Y-axis = amplitude, scaled to the peak envelope power; where minimum scaled amplitude = -1, maximum scaled amplitude = +1

Application: To analyze impairments, added noise and signals (e.g. from external baseband input) in the time domain. This mode shows the signal like an oscilloscope.

Signal acquisition points: See [Table 7-2](#).

Vector Diagram

The vector diagram displays the Q component over the I component. All points in the complex domain are connected by lines.

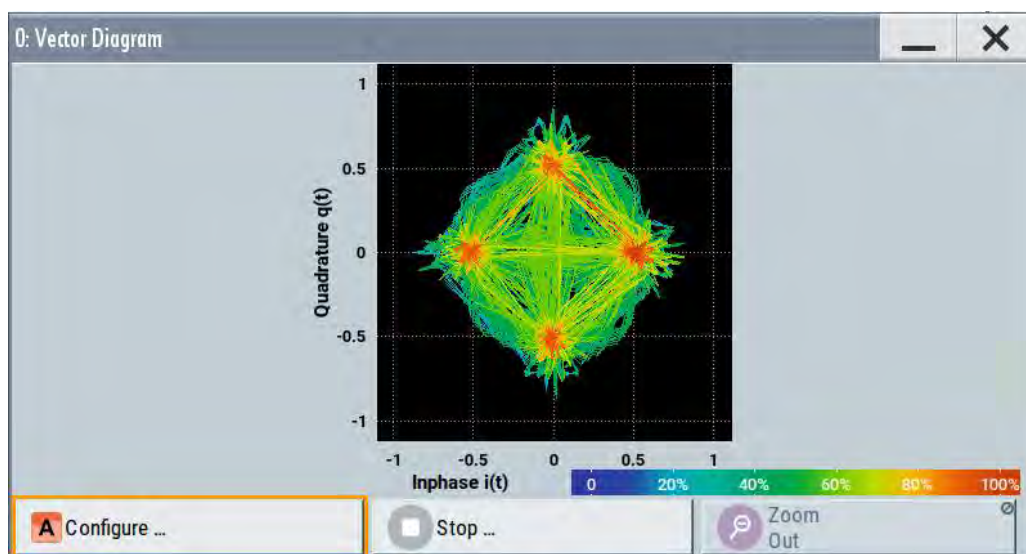

Figure 7-2: Vector diagram (64 QAM)

X-axis, Y-axis = amplitudes of the signal components, scaled to the peak envelope power; where minimum scaled amplitude = -1, maximum scaled amplitude = +1

Application: To analyze the transition between the various states of modulation mapping, especially with linear modulations like MSK, QPSK or QAM. This mode shows the signal like an oscilloscope (X/Y-mode).

Signal acquisition points: See [Table 7-2](#).

Constellation Diagram

Constellation diagrams display the modulation symbols as discrete points in the I/Q plane. Unlike the vector diagram, the constellation diagram displays only one sample per symbol. This sample represents the symbol.

Constellation diagrams are helpful when generating signals using the "Custom Digital Modulation" settings. Compare the displayed constellation diagram with the diagram displayed in the "Custom Digital Modulation > Modulation" dialog.

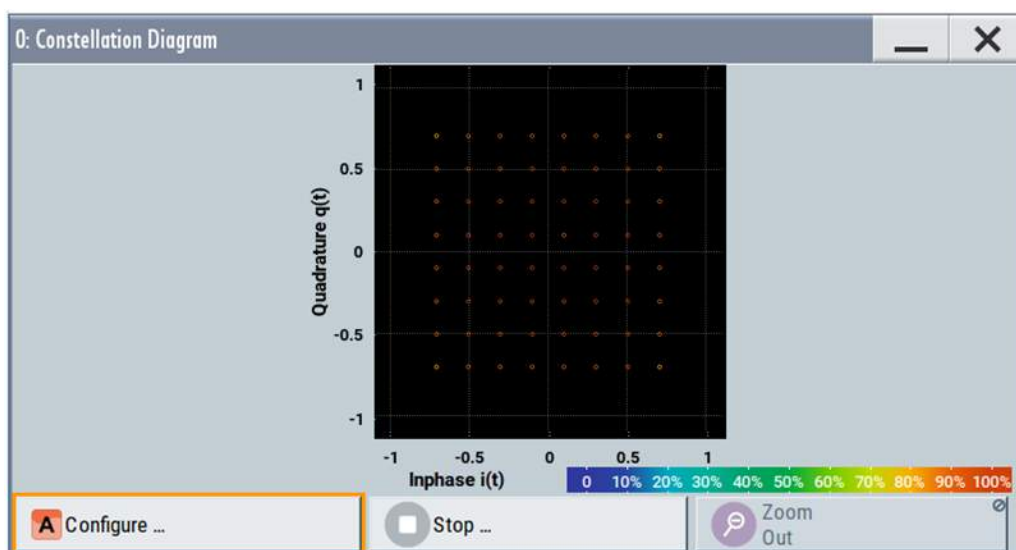

Figure 7-3: Constellation diagram (64 QAM)

X-axis, Y-axis = amplitudes of the signal components, scaled to the peak envelope power; where minimum scaled amplitude = -1, maximum scaled amplitude = +1

Application: To classify modulation.

Signal acquisition points: See [Table 7-2](#).

Eye Diagram

The eye diagram displays synchronized and superimposed sections of either the in-phase or the quadrature components of the signal.

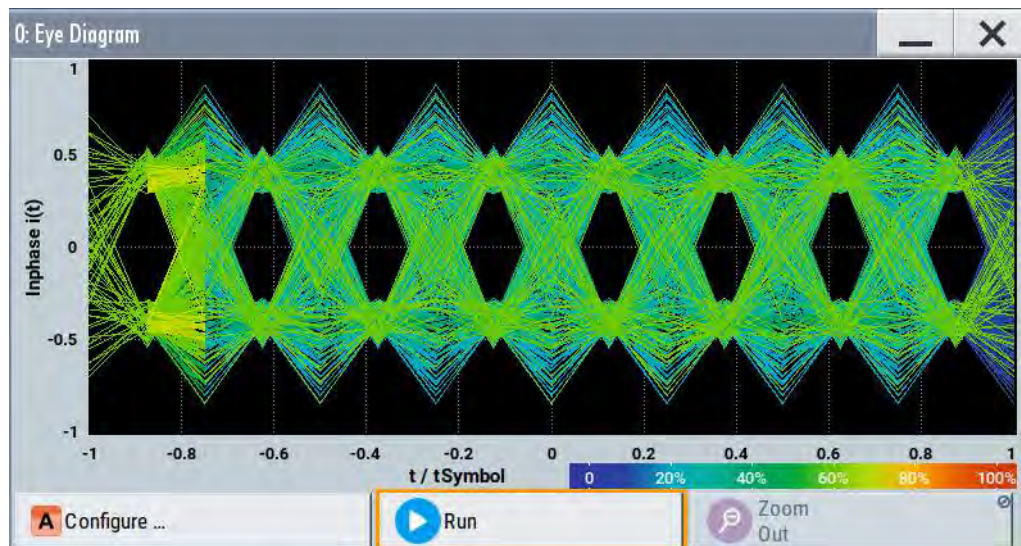

Figure 7-4: Eye diagram with partially closed eye (QPSK)

X-axis = time in the range of ± 1 symbol

Y-axis = amplitude, scaled to the peak envelope power; where minimum scaled amplitude = -1, maximum scaled amplitude = +1

The display width is normalized for 2 symbols. It uses one-symbol "eye opening" in the center of the display and 1/2-symbols to the left and right of the center eye for capturing time transitions. Several hundreds curve segments are superimposed. The beginning of the recording is synchronous to the symbol and chip clock pulse.

Application: To analyze amplitude and time distortion elements (e.g. jitter) at high-speed digital data systems. A high quality, unimpaired signal shows a clearly open eye (horizontally and vertically).

Signal acquisition points: See [Table 7-2](#).

CCDF Display

The complementary cumulative distribution function (CCDF) displays the probability with which the output signal exceeds the average power.

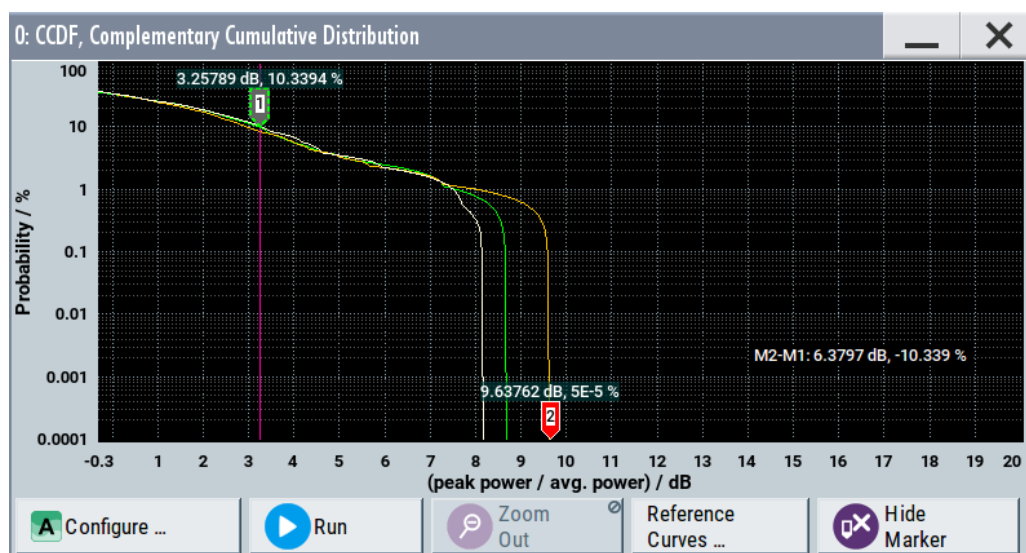

Figure 7-5: CCDF diagram of a 5 MHz LTE Signal (Level -30 dBm) and two reference curves

- X-axis = Level over the average signal power, where the average power (RMS) corresponds to the origin
 Y-axis = Probability of exceeding the average power, that is the percentage of time the signal spends at or above the power level specified by the X-axis
 Marker 1 = Interpolation: 10.3% of the samples exceed 3.3 dB above average; similarly 1% of the samples exceed 7.5 dB above average (not shown with a marker)
 Marker 2 = The point where the trace crosses the x-axis; indicates the highest peak that is found in the sample block and is 9.6 dB higher than average.

The CCDF diagram is calculated over 8 KSamples and corresponds to a signal with the following characteristics:

- "Baseband > LTE" and "Test Model > E-TM1_1__5 MHz"
- "Status bar > Level = - 30 dBm" and "Status bar > PEP = - 18.43 dBm"
 The difference between the level and the PEP results in the peak to average ratio. If the measurement is long enough, the displayed highest peak would correspond to the calculated crest factor.
 The PEP value does not indicate how often the peak level is reached. The CCDF shows the probability for reaching a dedicated instantaneous power.

Signal acquisition points: See [Table 7-2](#).

Power Spectrum

The power spectrum displays the signal spectrum which is calculated from the I/Q signal with fast Fourier transform (FFT). The power density over frequency is displayed.

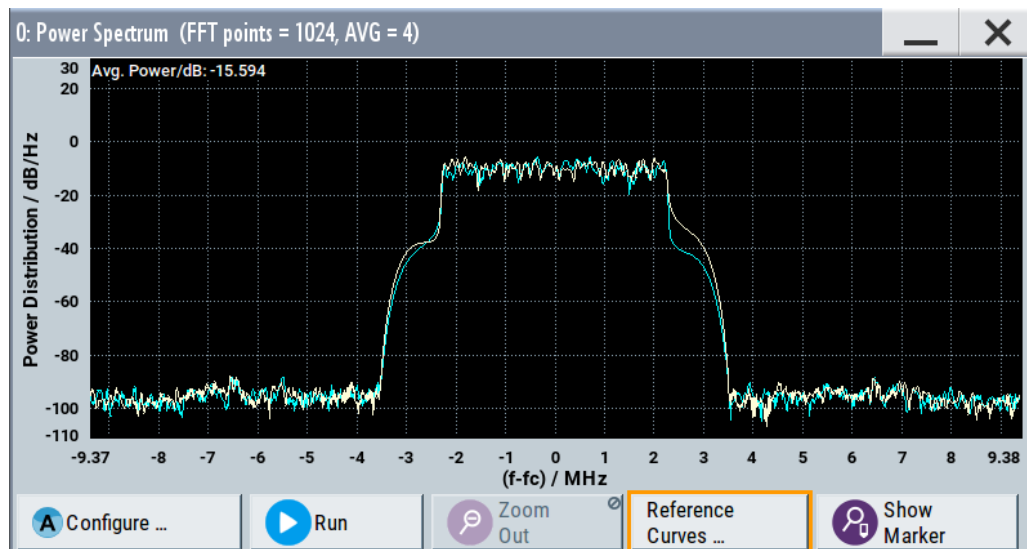

Figure 7-6: Power spectrum diagram of a 5 MHz LTE signal with enabled reference curve (blue)

"FFT points" = indicates the number of I/Q value pairs that are used for calculating a (part-)FFT
 "AVG" = indicates the number of subspectra used for averaging
 X-axis = frequency plotted symmetrically (- Sampling Rate/2 to +Sampling Rate/2)
 Y-axis = power density

Signal acquisition points: See [Table 7-2](#).

7.1.2.2 Signal Acquisition Points

Signal characteristics can be displayed using different methods and different acquisition points, also at the same time.

The following signal acquisition points are available:

- Baseband signals
- Input streams of the "IQ Stream Mapper"
- Analog outputs

The [Figure 7-7](#) shows an example for locations of signal acquisition points.

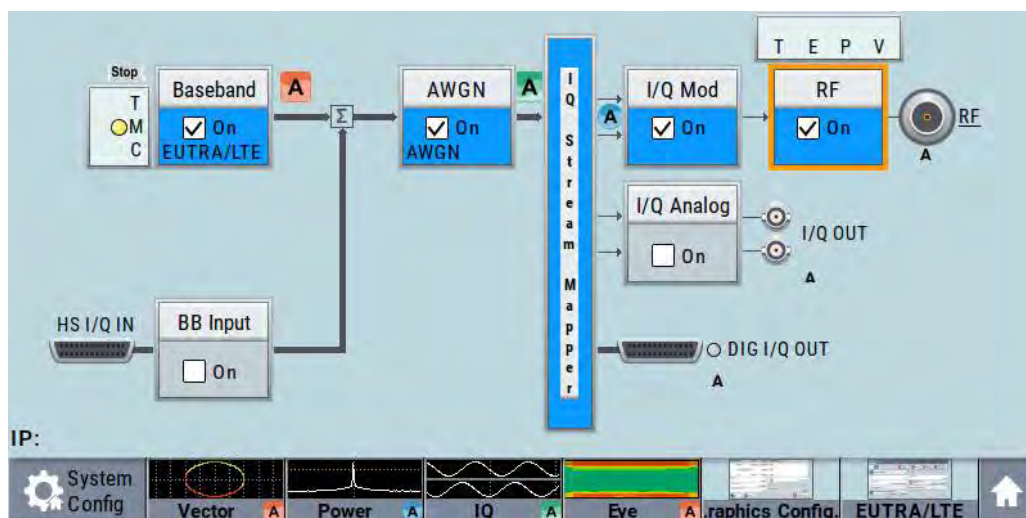

Figure 7-7: Block diagram with graphical signal display and signal acquisition points

The Table 7-2 shows which signal acquisition point is suitable for which kind of graphical signal display.

Table 7-2: Signal acquisition points for the different graphical displays

Graphics modes	Signal acquisition points
I/Q diagram, vector diagram, CCDF diagram, power spectrum diagram	All
Constellation diagram, eye diagram	Baseband signals

7.1.2.3 Display Functions

The graphical display provides general display functions known from other measurement instruments and offers zoom and markers.

Zooming

You can zoom into the diagram to visualize the measurement results in greater detail. Using the touchscreen or a mouse pointer you can easily define the area to be enlarged.

Zooming is merely a visual tool, it does not change the number of samples used for the calculation. You can increase the number of samples before zooming.



See also "To zoom into a diagram" on page 395.

Using markers

Markers are tools for numerical readout of measured data in diagrams. They help you analyze the displayed signal characteristics by determining particular values in the diagram.

Often you can use markers to measure the frequency distance of two peaks or to measure the power decrease of an oscillator at a given frequency offset, dBc value. Note that markers in the diagram are not related to the markers in the digital standards.

In the graphical display, the markers and their values (for example time or frequency) are displayed as usual.

Single marker indication	Delta marker indication
 <ul style="list-style-type: none"> • 1 = marker number • 2 = marker position on the x-axis in the current units • 3 = marker value on the y-axis 	 <ul style="list-style-type: none"> • 1 = delta marker • 2, 3 = result of the marker function, i.e. the delta values in the current units

See also "[To enable markers to readout exact measured data](#)" on page 395.

Persistence and color maps

In addition to the standard representation, the vector, the constellation, and the power spectrum diagrams use a color map.

The color encodes the relative amplitude (in percent) of the probability distribution of the data points in the diagram. A detailed breakdown of the colors is below diagrams the colors are relevant for. Data points in areas with high probability are marked in red, data points in areas with low probability in blue. Thus, for example, you can observe not only the "level versus frequency" trace but also a third dimension, the probability of the power level.

Reference trace

Reference traces help you analyze a displayed characteristic, as do the markers. Reference traces are used to define amplitude curves or spectral distribution boundaries in the result diagram which are not to be exceeded. They indicate, for example, the upper power limits which are allowed from a device under test (DUT).

The R&S SMBV100B supports up to five reference traces. You can load reference traces and activate them simultaneously.

7.1.3 Graphics Configuration Settings

This section focuses on the graphics configuration dialog, which determines the number and kind of the graphical signal displays.

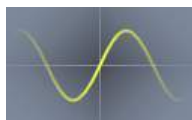

Access:

1. Select "Taskbar > System Config > Graphics" or use the wave icon.

The "Graphics Configuration" dialog opens.

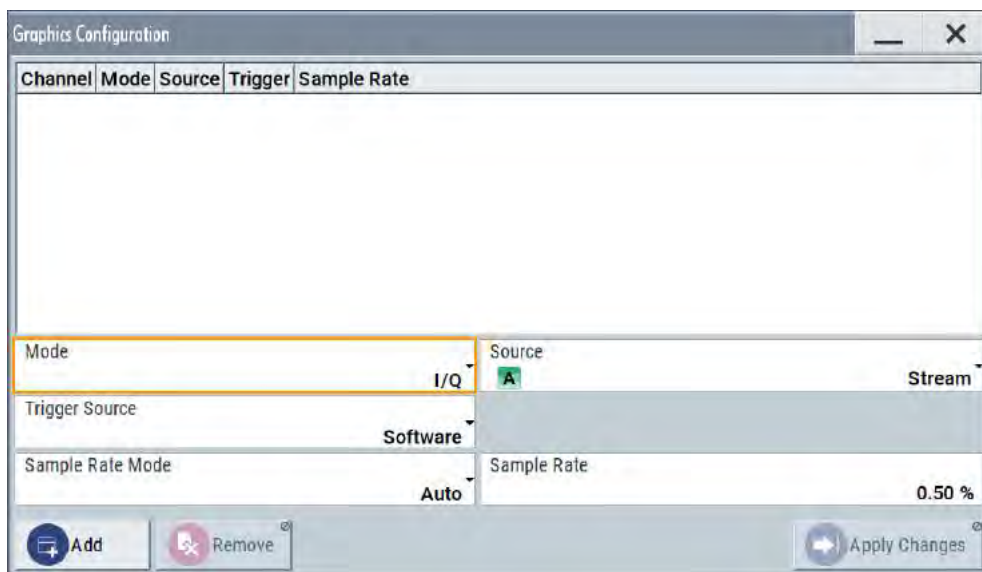

Figure 7-8: Graphics configuration dialog

2. To determine the kind of signal display, use the parameter "Mode".
3. To select suitable signal acquisition points, use the parameter "Source".
4. To enable the graphical signal display, select "Add".

A thumbnail of the graphical signal display is shown in the taskbar.

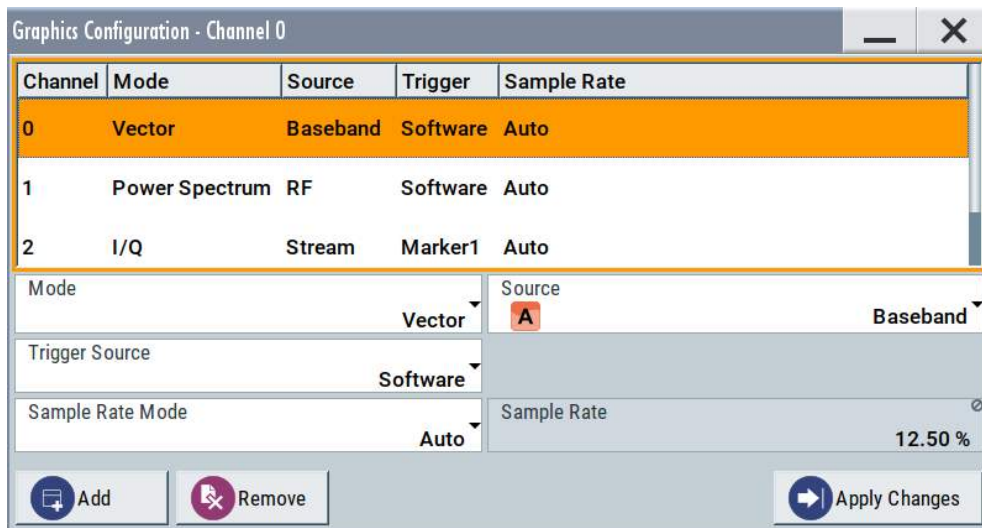

Figure 7-9: Graphics configuration dialog with active graphical signal displays

5. To enlarge the thumbnail, select it.

Settings:

Graphical Diagrams Table..... 387

Mode..... 387

Source..... 387

FFT Length.....	387
Full Scale (dBFS).....	387
Trigger Source.....	387
Sample Rate Mode.....	388
Sample Rate.....	388
Add.....	388
Apply Changes.....	388
Remove.....	389

Graphical Diagrams Table

The active graphical signal displays are listed in the table at the top of the dialog.

Mode

Determines the graphics mode, see [Chapter 7.1, "Displaying Baseband Signal Characteristics in Real-Time"](#), on page 378.

Remote command:

`[:SOURce<hw>] :BB:GRAPhics:MODE` on page 799

Source

Defines the signal acquisition point, see [Chapter 7.1.2.2, "Signal Acquisition Points"](#), on page 383.

Remote command:

`[:SOURce] :BB:GRAPhics:SOURce` on page 800

FFT Length

In "Mode > Power Sepectrum", selects the number of samples to be included in the graph of the power spectrum.

Remote command:

`[:SOURce] :BB:GRAPhics:FFTLen` on page 801

Full Scale (dBFS)

In "Mode > Power Spectrum", determines the normalization of the power values in the diagram.

Observe the change in the units on the y-axis.

"On" The maximal digital power $|I|=|Q|=max$ is mapped to 0 dB in the power spectrum diagram.

The y-axis shows the normalized power in dBFS.

"Off" The frequency average of the displayed power (frequency domain) agrees with the average power in the time domain.

The y-axis shows the power distribution in dB/Hz.

Remote command:

`[:SOURce] :BB:GRAPhics:FFTFscale` on page 801

Trigger Source

Defines the trigger for signal recording.

"Software"	Recording of signals starts automatically in predefined intervals. This asynchronous method is suitable if a representative display of the complete signal is required.
"Marker 1"	The starting point for recording of signals is determined by the marker 1 setting of the activated digital standard ("Trigger/Marker" dialog). This synchronous method is suitable if specific signal segments are to be shown in greater detail. With periodic signals, a static image is obtained by selecting a period length of marker 1 that is equal to the signal period. The displayed signal segment can be shifted by entering a marker delay in the "Trigger/Marker" dialog of the activated digital standard.

Remote command:

[\[:SOURce<hw>\]:BB:GRAPhics:TRIGger:SOURce](#) on page 801

Sample Rate Mode

Sets how the time resolution of the signal is determined. Maximum resolution corresponds to a display covering the entire signal bandwidth. The higher the resolution, the shorter the length of the displayed signal segment.

"Auto"	The resolution is set to an optimum value in terms of signal and display type.
"Full Bandwidth"	The resolution is set so that the display covers the entire signal bandwidth.
"User"	Activates the "Sample Rate" input field, where you can manually set the resolution.

Remote command:

[\[:SOURce<hw>\]:BB:GRAPhics:SRATe:MODE](#) on page 799

Sample Rate

- If "Sample Rate Mode = Auto/Full Bandwidth"
Displays the percentage of the entire signal bandwidth which is used for the graphical signal display.
- If "Sample Rate Mode = User"
Input for the percentage of signal bandwidth which is used for the graphical signal display.

Remote command:

[\[:SOURce<hw>\]:BB:GRAPhics:SRATe:USER](#) on page 800

Add

Adds a graphical signal display (as set in the "Graphics Configuration" dialog) to the taskbar/graphical diagrams table.

Remote command:

[\[:SOURce\]:BB:GRAPhics:ADD](#) on page 800

Apply Changes

Enables the current settings for the selected graphical signal display.

Remove

Removes the selected graphical signal display from the taskbar/graphical diagrams table.

Remote command:

[:SOURce] :BB:GRAPhics:CLOSe on page 800.

Note, that this command closes all graphical signal displays.

7.1.4 Graphical Signal Display Settings

Access:

1. Select "Taskbar > System Config > Graphics > Add".
2. Double click the thumbnail in the taskbar.

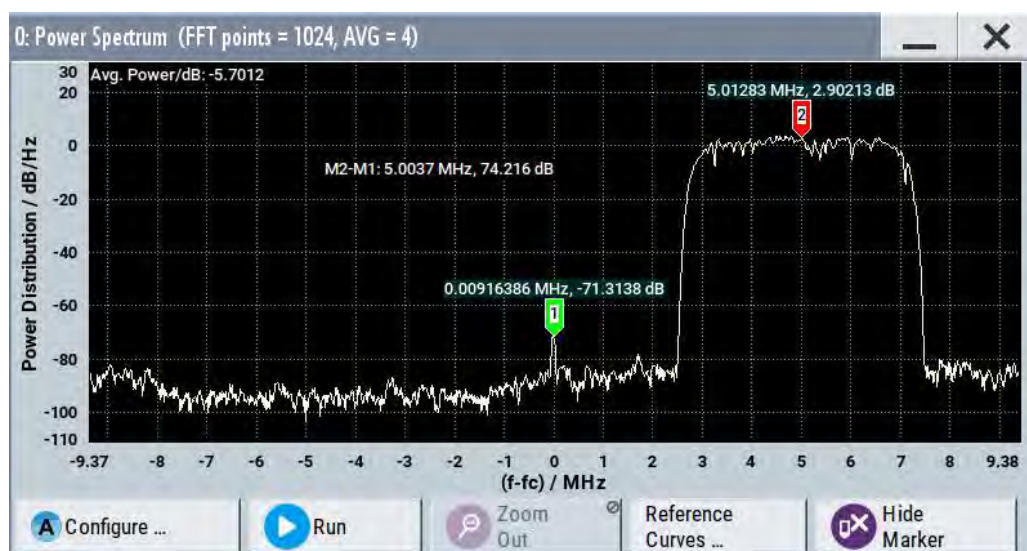

Figure 7-10: Graphical signal display of a power spectrum with markers

This section focuses on the functions of the enlarged graphical signal displays.

Settings:

Configure.....	389
Stop / Run.....	390
Zoom Out.....	390
Reference Curves.....	390
Display Units.....	390
Show / Hide marker.....	390
Reference Curve.....	390

Configure

Opens the "Graphics Configuration" dialog, see [Chapter 7.1.3, "Graphics Configuration Settings"](#), on page 385.

Note: This function is available for enlarged graphical signal displays and in the context menus of the thumbnails.

Stop / Run

Stops the processing of the displayed signal and freezes it.

"Run" continues a stopped displayed signal.

Zoom Out

Resets a previous zoom, see also ["To zoom into a diagram"](#) on page 395.

Reference Curves

Accesses the dialog for defining reference curves, see ["Reference Curve"](#) on page 390.

Display Units

Changes the units of the X-axis. The available values depend on the generated signal.

Show / Hide marker

Sets two markers to the displayed signal or hides them.

See also:

- ["Using markers"](#) on page 384
- ["To enable markers to readout exact measured data"](#) on page 395

Reference Curve

Enable the indication of up to five configurable reference curves (traces).

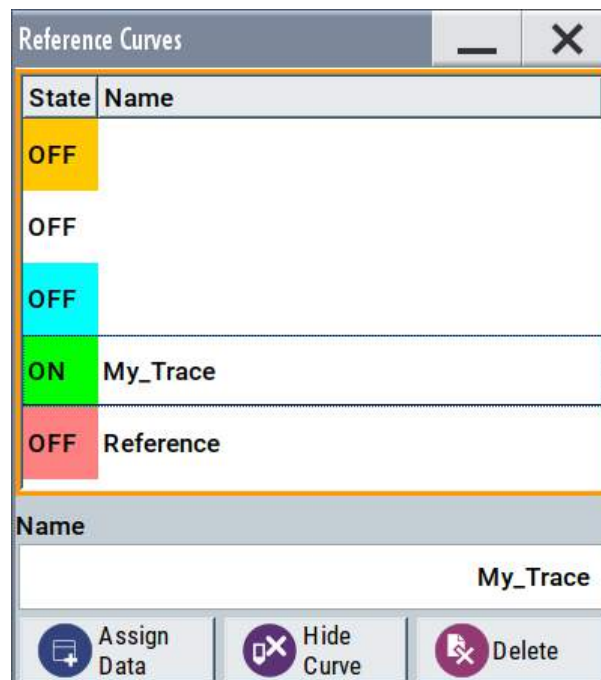

See ["Reference trace"](#) on page 385.

"Reference Curves Table"	Lists the configured reference curves and their current state. To change a curve, select it.
"Name"	Enters the name of a new reference curve
"Assign Data"	Accesses the standard "File Select" function to load a file describing a reference curve
"Show Curve"	Toggles the show/hide state of the selected curve
"Delete"	Removes the curve

7.1.5 How to Verify the Generated Signal with the Graphics Display

This section shows you how to use the different graphic modes to visualize the signal characteristics of the generated signal. It shows also how to observe the effect of standard settings, like applied filter, an enabled fading or AWGN. The examples use a simple custom digital modulated signal.

To generate a simple WCDMA-3GPP (QPSK 45° offset) signal

- ▶ Use the custom digital modulation. Enable a predefined WCDMA-3GPP signal. For more information, see [Chapter 2.3.2, "Generating a Digitally Modulated Signal"](#), on page 53.

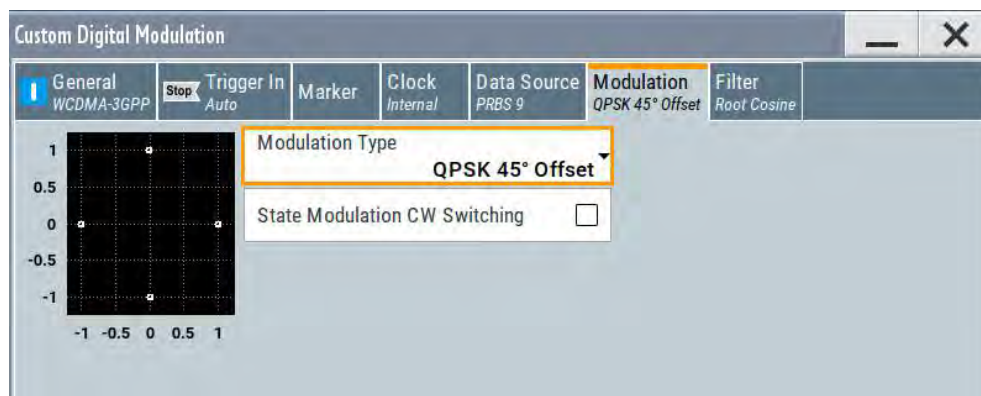

Figure 7-11: Used modulation type

Configure the graphical signal display

1. Select the wave icon:



The "Graphics Configuration" dialog opens.

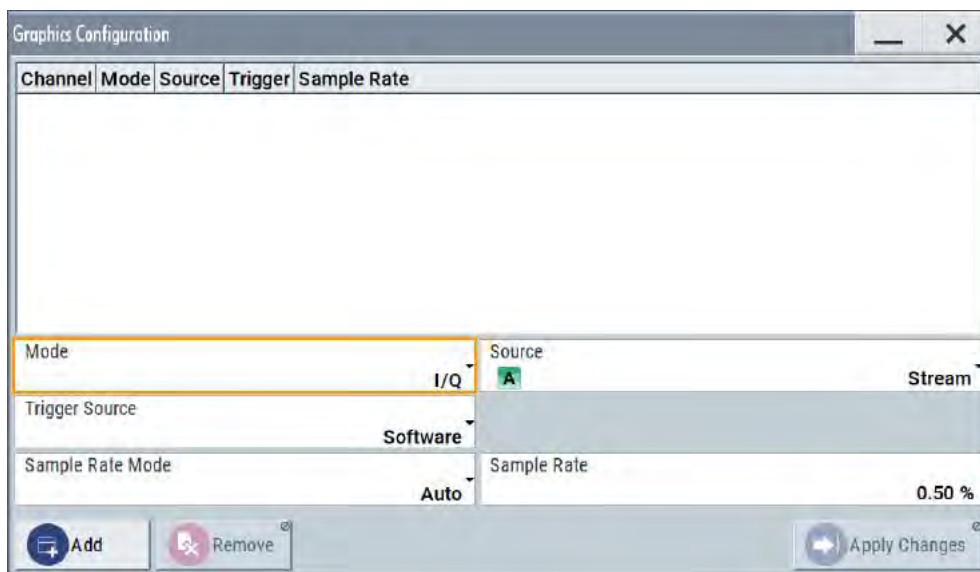

2. Select "Mode > Constellation".
3. Select "Source > Baseband".
4. To view the signal, select "Add".



A new thumbnail (minimized view) indicating the constellation diagram appears in the "Taskbar".

5. To enlarge the constellation diagram, select it.

The displayed constellation diagram confirms the used modulation type, see [Figure 7-11](#).

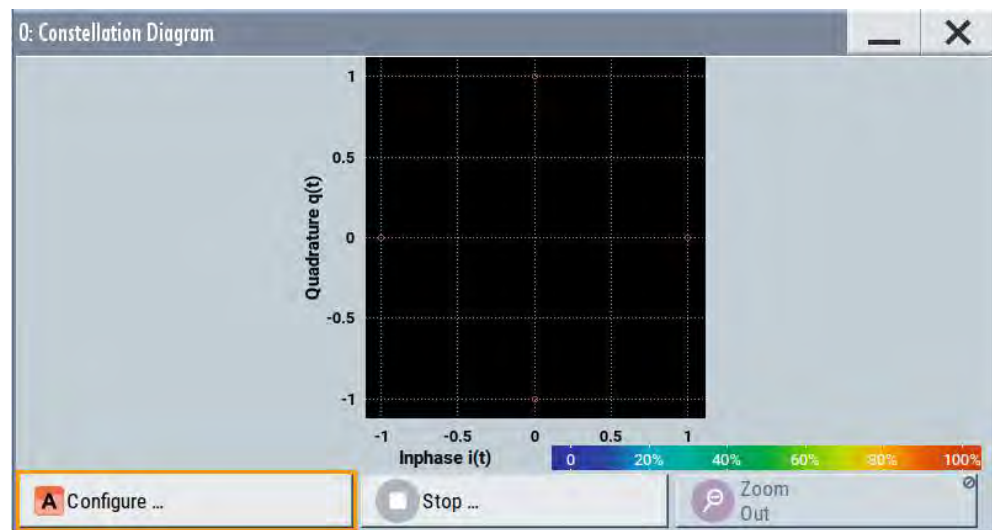

Figure 7-12: Constellation diagram of a WCDMA-3GPP (QPSK 45° offset) signal

To set and verify a baseband frequency offset

1. In "Baseband > Baseband Offsets", set "Baseband > Frequency Offset = 1 Hz"

	Frequency Offset /Hz	Phase Offset /°	Gain /dB
Baseband A	1.00	0.00	0.000
BB Input A	0.00	0.00	0.000

2. In the "Constellation Diagram", select "Configure".
The "Graphics Configuration" dialog opens.
3. Add a vector diagram with signal acquisition point "Stream" and enlarge it.
The vector diagram rotates with 1 Hz.

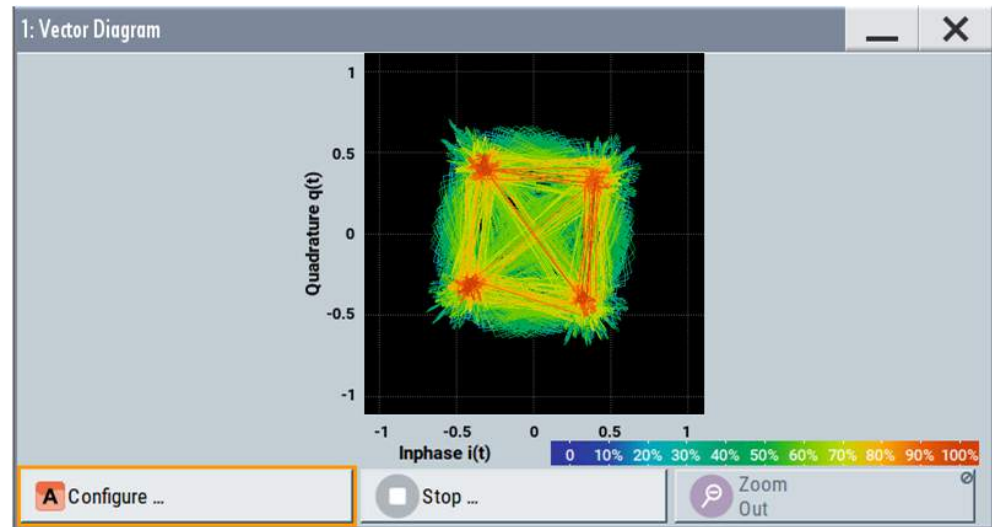

Figure 7-13: Rotating vector diagram

4. Reset the baseband frequency offset to 0 Hz.
The vector diagram does not rotate any more.

To visualize the effect of the filter parameters on the generated signal

1. Select "Baseband > Custom Digital Mod... > Filter > Roll Off Factor = 0.99"



The vector diagram changes.

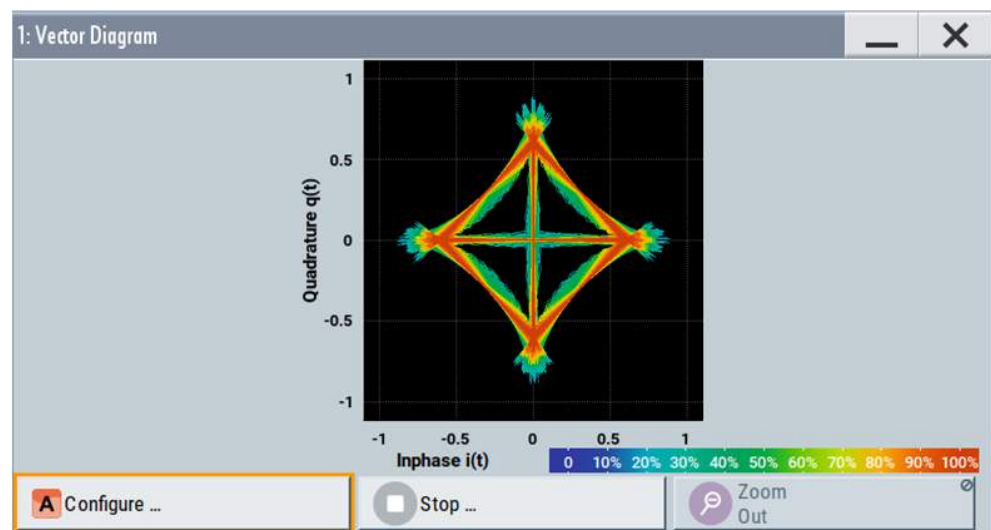

2. Select "Roll Off Factor", open the context menu, and select "Preset this parameter".

To zoom into a diagram

In an enlarged diagram:

1. Use the one-finger zoom to zoom with a fixed zoom factor.
2. Use the two-finger zoom to do a custom zoom.
This zoom works like the two-finger pinching for magnifying images on your cell phone.
If the diagram is zoomed, an overview window appears.
3. Move the visible area in the graphics or in the overview window.
4. For the reverse operation, select "Zoom out".

To enable markers to readout exact measured data

In an enlarged diagram:

1. Select "Show Marker".
Two markers appear, one over the other.
2. To position the markers, select and shift them.
"M2-M1" indicates the distance of marker 1 and marker 2 on the x-axis (left value) and on the y-axis (right value).

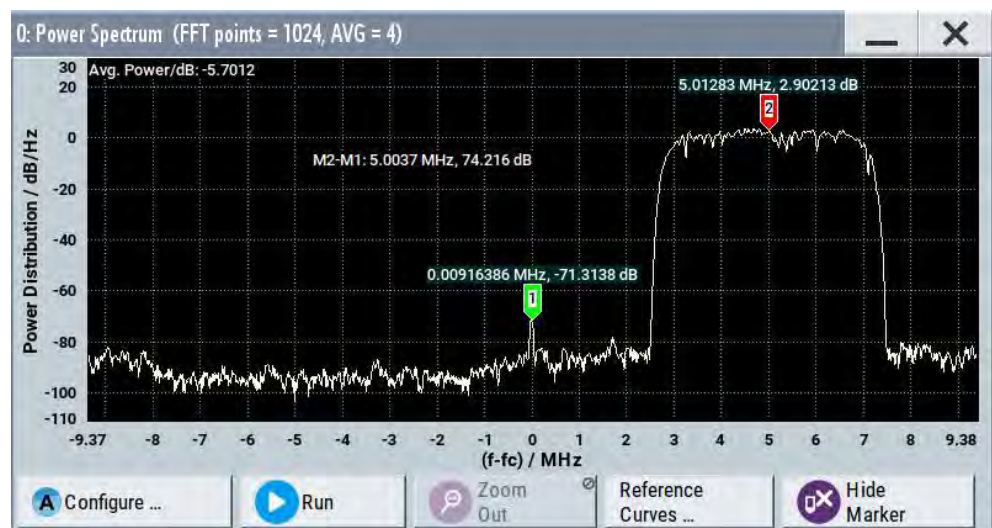

- To hide the markers, select "Hide Marker".

To observe the effect of enabled additive noise (AWGN)

- Select "AWGN > General > Mode > Additive Noise".
- Select "AWGN > General > Min Noise/System Bandwidth Ratio = 3".
- Select "Noise Power / Output Results > Carrier/Noise Ratio = 30 dB".

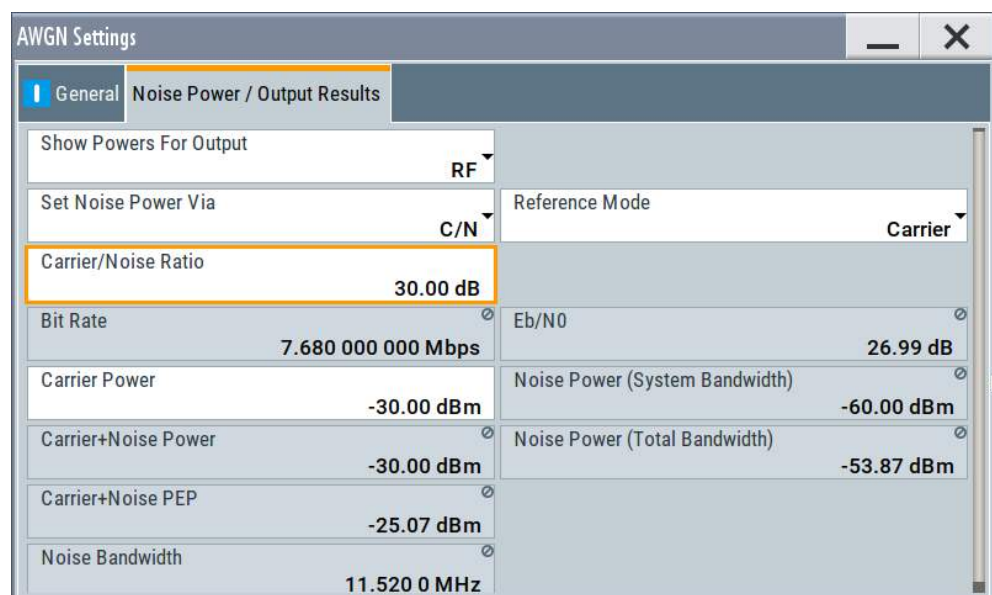

- Select "AWGN > State > On"
- Observe the power spectrum display.

The power spectrum shows a noise floor with constant level and the spectrum of the digitally modulated signal, in this case the WCDMA signal with a bandwidth of 3.84 MHz.

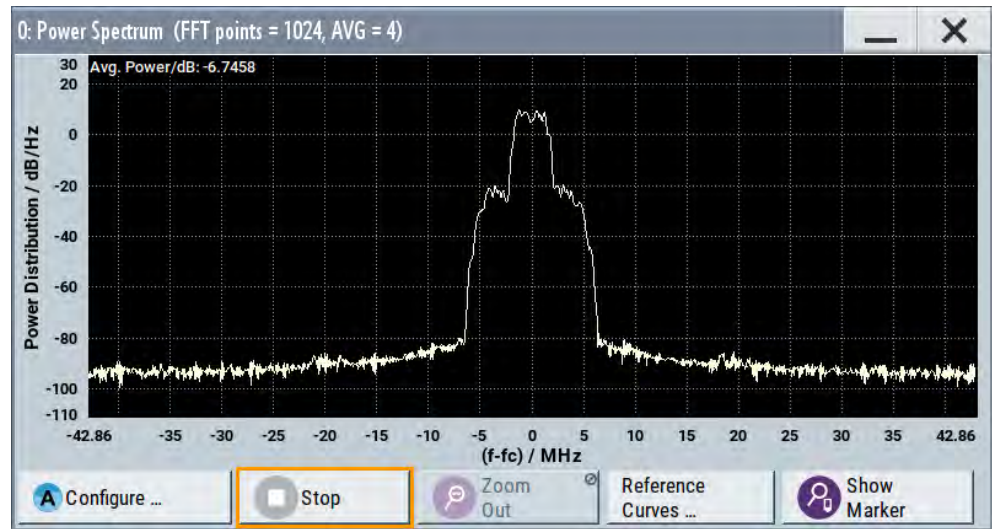

To print current power spectrum

1. Select "System Config > Setup > User Interface > Hardcopy".
2. Use the default settings and select "Save".
The instrument creates a screenshot of the current screen and stores it in a file with a predefined filename in the default user directory `/var/user/`.
See [Chapter 9.10, "Creating Screenshots of Current Settings"](#), on page 474.
3. Use one of the standard file transfer methods to access the user directory of the instrument. Transfer the file to a PC.
See [Chapter 9.9, "How to Transfer Files from and to the Instrument"](#), on page 468.
4. Print the file content.

8 Multi-Instrument Setups

R&S SMBV100B is rarely used as a standalone instrument. Usually, the instrument is connected to a device under test (DUT) or other measurement equipment.

Test setups have different requirements, for example:

- Test setups comprising two or more devices often require a common reference frequency.
- Generation of beamforming signals requires phase coherent signals.
- Some test setups also require control of the signal generation start and an exact generation start time, for example determined by a defined trigger event.
- In other cases, you would need time-aligned simultaneous signals between multiple instruments.
- etc.

R&S SMBV100B provides several settings that help fulfilling these requirements. This section explains main principles and gives an overview of the related settings and step-by-step instructions.

• Synchronizing Instruments	398
• Generating Phase-Coherent Signals	398
• Generating Time-Aligned Baseband Signals	399
• Control and Operation of External Instruments	406
• System Configuration Settings	413
• Digital Baseband Input Settings	426
• I/Q Analog Output Settings	435

8.1 Synchronizing Instruments

For information on the possible scenarios concerning the distribution of reference frequency, test setups and the related settings:

See [Chapter 6.8, "Reference Oscillator"](#), on page 272.

8.2 Generating Phase-Coherent Signals

The R&S SMBV100B provides a build-in function that allows a distribution of the local oscillator signal in a way that multiple RF signals can be derived from the same LO signal. LO coupling is mandatory for minimizing the phase fluctuations between these RF signals, as it is for example required for the generation of beamformed signals.

For information on the possible scenarios, test setups and the related settings:

See [Chapter 6.9, "Local Oscillator Coupling"](#), on page 279.

8.3 Generating Time-Aligned Baseband Signals

In test setups that combine the signal of two or more instruments it is often required that:

- The signal generation starts at a defined moment
- The signal generation starts simultaneously (or with an exactly defined delay) in all involved instruments.

One possible way to achieve quasi-simultaneous signal start is to trigger the instruments by the same trigger event, for example from a **common trigger source**.

Because of the trigger signal propagation time and the signal processing time, however, this method does not achieve precise time aligned signals.

To generate **synchronous and time aligned signals** with multiple instruments, use the **master-slave mode**.

This section explains how to use the provided settings to define the signal generation start in the basebands of **multiple instruments**.

- [Connecting Multiple Instruments in Master-Slave Mode](#).....399
- [Triggering Several Instruments with a Common Trigger Signal](#).....405

8.3.1 Connecting Multiple Instruments in Master-Slave Mode

About the master-slave mode

When connected in master-slave mode, two or more R&S SMBV100B or one R&S SMBV100B and several other signal generators such as R&S SGT or R&S SMBV can generate synchronous and time aligned signals.

In this mode, the master instrument generates and outputs a dedicated synchronization signal (Sync Out), that has to be fed into the slave instrument. The slave instrument detects and demodulates the signal, and retrieves both the baseband clock and the trigger signal from it. Slave instruments can forward the received synchronization signal (Sync In) and output it to trigger further slaves.

Synchronization signal

The synchronization signal is a 50 MHz signal that carries the trigger pulse modulated on it. Hence, it provides **joint triggering** and **baseband clock synchronization** at the same time.

Final time alignment can require adding I/Q or trigger delay. However, once synchronization is achieved, the master-slave mode ensures reproducibility of triggering, if the used waveform, sample rate and cabling are not changed.

Test setup

Regarding the **synchronization signal**, the instruments can be connected (cascaded) in a **star configuration** (see [Figure 8-2](#)) or in a **daisy chain** (see [Figure 8-1](#)).

Additionally, all instruments in the setup have to use the **same reference frequency**. You can distribute the internal reference frequency of one of the instruments, regardless if master or slave, to all other or supply all instruments from an external reference frequency source.

8.3.1.1 Multi-Instrument Settings

Access:

- ▶ Use one of the following:
 - Select "Taskbar > System Config > System Configuration > Multi Instrument"
 - Select "Block Diagram > I/Q Stream Mapper > System Configuration > Multi Instrument"
 - On the instrument front panel, press [Setup].
Select "System Configuration > Multi Instrument".

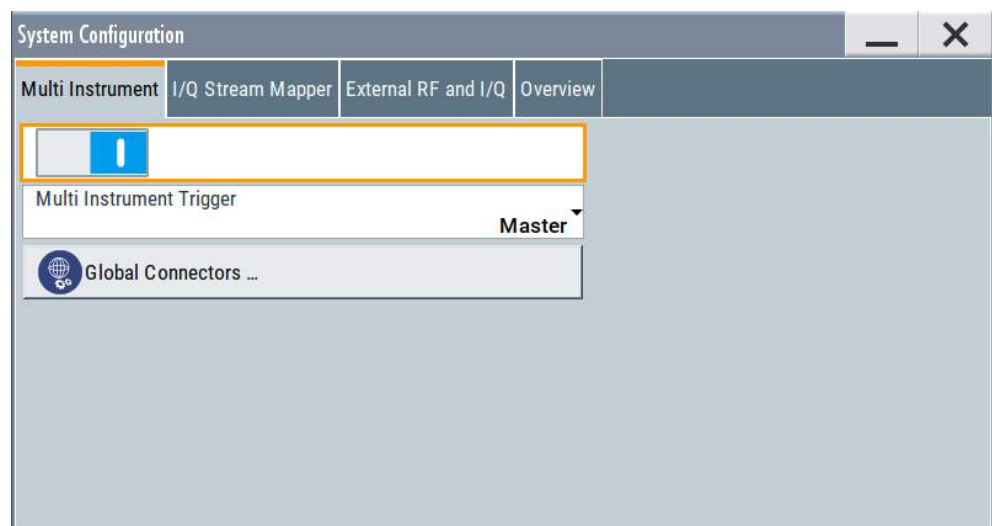

For step-by-step description, see [Chapter 8.3.1.2, "How to Connect and Configure Instruments in Master-Slave Mode"](#), on page 401.

Settings:

State	400
Multi Instrument Trigger	401
Synchronisation State	401
Global Connector Settings	401

State

Activates the configuration.

With "State = Off", the instrument works in a standalone mode.

Remote command:

[:SCONfiguration:MULTiinstrument:STATe](#) on page 635

Multi Instrument Trigger

Sets the mode in that the instrument works.

To activate the mode, set "Multi Instrument > State = On".

"Master"	Provides its trigger signal to the slaves
"Slave"	Synchronizes to the supplied trigger signal from the master. Observe the "Synchronisation State" indication for information if the synchronization signal is found and synchronization is achieved.

Remote command:

`:SCONfiguration:MULTiinstrument:MODE` on page 635

Synchronisation State

If "Multi Instrument Trigger = Slave", indicates if synchronization is achieved.

"Sync"	Instrument is in sync. It receives and decodes the synchronization and the trigger signal from the master instrument.
"No Sync"	Synchronization is not achieved, because: <ul style="list-style-type: none"> • The baseband generators in the slaves or in the master instruments are not activated, see "To start signal generation" on page 404. • There is no physical connection (the synchronization signal is not connected as required). For details, see Chapter 8.3.1.2, "How to Connect and Configure Instruments in Master-Slave Mode", on page 401. • The slave instrument does not detect the synchronization signal.

Remote command:

`:SCONfiguration:MULTiinstrument:TRIGger:SYNChronization?`
on page 636

Global Connector Settings

Provides a quick access to the related global connector settings.

With "State = On", the synchronization signal is assigned per default as follows:

- "Multi Instrument Trigger > Master"
"Connector = User 5": "Direction = Output", "Signal = Baseband Sync Out"
- "Multi Instrument Trigger > Slave"
"Connector = User 5": "Direction = Output", "Signal = Baseband Sync Out"
"Connector = User 4": "Direction = Input", "Signal = Baseband Sync In"

See also:

- [Chapter 8.3.1.2, "How to Connect and Configure Instruments in Master-Slave Mode"](#), on page 401.

See [Chapter 10.2, "Configuring the Global Connectors"](#), on page 486.

8.3.1.2 How to Connect and Configure Instruments in Master-Slave Mode

Proceed as follows:

- [Connect the instruments and distribute the synchronization signal and the reference frequency](#)

- Configure the master R&S SMBV100B
- Configure the slave R&S SMBV100B
- Compensate signal mis-alignment:

Connect the instruments and distribute the synchronization signal and the reference frequency

1. With the default connector settings of the R&S SMBV100B, connect the instruments in one of the following ways:

- a) In a daisy chain:

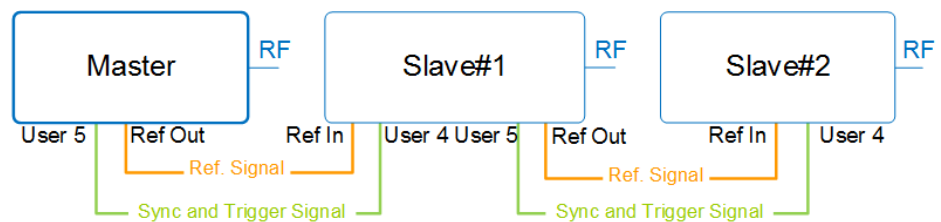

Figure 8-1: Example: Daisy chain connection for distributing the synchronization signal (simplified)*

* = I/Q, LAN etc. connections are not shown

Master = Instrument acting as synchronization and trigger signal source

Slave = One or more cascaded instruments, receiving (and forwarding) the synchronization and trigger signal

Ref Out, Ref In = Reference frequency connectors

User x = Synchronization and trigger signal connectors

RF = Signal output

- Connect **User 5** connector of the master R&S SMBV100B to **User 4** connector of the first slave.
 - Connect User 5 connector of the first slave to the User 4 connector of the second slave, etc.
- b) In a star configuration:

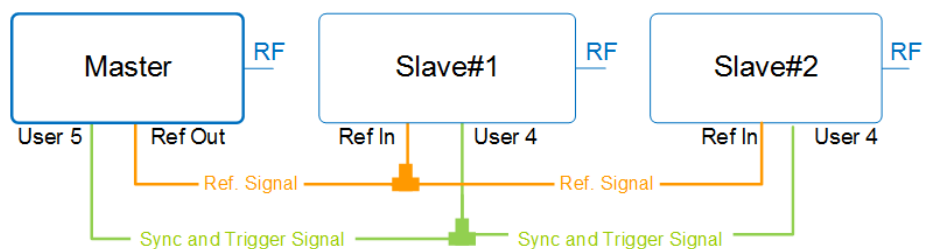

Figure 8-2: Example: Star configuration for distributing the synchronization signal (simplified)*

* = I/Q, LAN etc. connections are not shown

- Connect User 5 connector of the master R&S SMBV100B to User 4 connector of the slaves
- Route the synchronization signal Sync Out accordingly.
See "Configure the slave R&S SMBV100B" on page 403

Note: Avoid unnecessary cable length and branching points.

Use cables of the same length and type for all connections between the master and the slaves and between slaves.

2. To distribute the internal reference signal of one of the instruments (in this example the master), connect the instruments in a **daisy chain concerning the reference frequency**.

That is, connect Ref Out of the master R&S SMBV100B to the Ref In of the first slave, etc.

See [Chapter 6.8, "Reference Oscillator"](#), on page 272.

Configure the master R&S SMBV100B

1. Select "RF > Reference Frequency > Source > Internal".
2. Select "System Config > System Config > Multi Instruments".
3. Select "Multi Instrument Trigger" > **"Master"**.
4. Select "State > On".
5. In the "Global Connector Settings" dialog, and observe current signal assignment. Per default, the synchronization signal ("Baseband Sync Out") is output at the **User 5**.
6. If you use [star configuration](#): in the "Global Connector Settings" dialog, for all connectors on that you want to output the synchronization signal:
 - a) Set "Direction > Output "
 - b) Set "Signal > Baseband Sync Out"
7. Configure the baseband signal as required for the particular test setup. Configure the trigger signal for example as follows:
 - a) Select "Baseband > EUTRA/LTE > Trigger In"
 - b) Select "Trigger Mode > Armed Retrigger" and "Trigger Source > Internal"
 - c) Set "Sync. Out to Trigger > On".

The trigger parameters of all basebands are coupled. Once the basebands are activated, they will use common trigger signal.

See also ["Starting the signal generation with the first sample"](#) on page 101.

Configure the slave R&S SMBV100B

1. Select "RF > Reference Frequency > Source > External".
Use the default reference frequency settings.
2. Select "System Config > System Config > Multi Instruments > Multi Instrument Trigger" > **"Slave"**.
3. Select "State > On".
4. Observe current synchronization status.

The parameter indicates that the instruments are not synchronized.

Synchronization is achieved at the moment the basebands in the slaves and in the master are activated.

5. Configure the baseband signal.
 - a) Select the same trigger mode as in the master instrument.
 - b) Set "Sync. Out to Trigger > On".
 - c) Observe the automatically selected **"Trigger Source = Baseband Sync In"**

Once the baseband is activated, the slave instruments are triggered by the synchronization signal.

If the slave instrument is R&S SMBV100B, the trigger parameters of all basebands are coupled and all basebands use common trigger signal.

To start signal generation

1. In the slave instruments, start signal generation.
That is, activate the baseband generator.
2. In the master instrument, activate the baseband generator.
3. In the slave instruments, observe the value of the parameter "System Config > Multi Instruments > Synchronization State"

The instruments are synchronized if:

- The physical connection is established
- The synchronization signal is routed properly
- The baseband generators in all generators are active.

Compensate signal mis-alignment:

1. Connect an oscilloscope or network analyzer.
Observe the generated signals.
2. Compare the signal start in the instruments.
3. To compensate signal delay, select "I/Q Modulator > I/Q Digital Imperilments"
4. Vary the value of the parameter **"I/Q Delay"** to achieve time aligned signals.
5. If the value range is insufficient, enable additionally or alternatively a trigger delay.
Select "Baseband > <Dig Standard> > Trigger In" > **"Delay"**.
6. Vary the values until the signals are aligned in time.

8.3.1.3 Further Information

See:

- Trigger settings of the used baseband source, for example [Chapter 3.4.2.1, "Trigger Settings"](#), on page 110.

See [Chapter 10.2, "Configuring the Global Connectors"](#), on page 486.

8.3.2 Triggering Several Instruments with a Common Trigger Signal

Using the same trigger event on several instruments is useful to synchronize the transmitted and received signals. Some test cases also require that you control the signal generation start and determine the exact generation start time by a defined trigger event. The signal generation start can be controlled for example by triggering the instrument internally or externally from the DUT.

To share common trigger signal:

- Let one R&S SMBV100B generate a dedicated signal that triggers all R&S SMBV100B instruments.
See [Example "Triggering several R&S SMBV100B instruments simultaneously"](#) on page 405.
- Connect all instruments to a common external trigger source.

See [Chapter 2.3.4, "Enabling and Configuring a Marker Signal"](#), on page 60.

Example: Triggering several R&S SMBV100B instruments simultaneously

This example shows you how to connect several R&S SMBV100B, distribute the trigger signal generated by the first one (R&S SMBV100B#1) and trigger the instruments simultaneously.

Required cabling and connections:

- Connect the instruments in a star network, concerning the trigger signal. That is, connect the User 5 output of the R&S SMBV100B#1 to the User 3 input of all other R&S SMBV100B and the R&S SMBV100B#1 itself.
- Always use cables of the same length. Use as short as possible cables.



- T = T-connector
 1 = Trigger source (R&S SMBV100B#1)
 2, 3 = N number of instruments (R&S SMBV100B#2 to R&S SMBV100B#n)
 User x = Connectors
 <- = Executes trigger manually

Required configurations:

- In **all** R&S SMBV100B:

- Use the default settings "User 3 > Direction = Input" and "Signal = Global Trigger 1".
- Select "Baseband > ... > Trigger In > Trigger Source > Ext. Global Trigger 1".
- In R&S SMBV100B#1, set "System Config. > Setup > Global Connectors">"**User 5**">"Direction = Output".
Set "User 5 > Signal = Manual Trigger".

To trigger the signal generation from R&S SMBV100B#1, select "Global Connectors > Execute Trigger".

Alternatively, send the remote control command `:OUTPut:USER<ch>:TRIGger[:IMMediate]`.

R&S SMBV100B#1 generates a short high signal and outputs it at the User connector. The signal acts as a common external trigger signal for all R&S SMBV100B and all basebands.

8.4 Control and Operation of External Instruments

In test scenarios that require more than one RF signals, the I/Q analog and digital output signal can be routed to and processed by external instruments. Typically, the generated I/Q streams are further processed by R&S SGT or R&S SGS.

The R&S SMBV100B provides all settings required to configure the output connectors, to establish the connections to the connected RF instruments and to control them. The settings are grouped in the "System configuration" > [External RF and I/Q](#) dialog. In this dialog, you find an overview of all available I/Q input and output connectors and configure the connection to the external instruments.

Once the connection is established, the R&S SMBV100B acts as a **master instrument** and controls the **setup-related parameters** of any connected further processing external instrument. Among others, this applies to connected R&S SGT, R&S SGS (also in combination with R&S SGU) or R&S SMBV100A.

8.4.1 About Signal Routing and System Configuration

Provided the instrument is equipped with the required options, R&S SMBV100B can:

- Process the internally generated digital baseband signal
- Process an external digital signal
- Generate vector-modulated baseband signals, irrespectively of the signal source
- Impair and add noise to digital baseband signals.

Generally, the processing of the generated baseband signal involves a modulation on the selected radio frequency (RF) and output at the RF connector. However, the digital baseband signal can also be output directly, or converted and output as an analog I/Q signal.

To support you in your configuration tasks, the R&S SMBV100B provides the "System Configuration" dialog. The main focus of this section is the "System Configuration" set-

tings. This section also introduces the concept of the signal routing possibilities and covers the settings provided for the adjustment of the input and output analog and digital signals.

8.4.1.1 Prerequisites for Control of External Instruments from the R&S SMBV100B

Required are the following connections between the R&S SMBV100B and the external instruments:

- **Physical remote control connection** over LAN or USB
The remote control connection to the external instruments must be in status **connected**.
See [Chapter 8.5.2, "External RF and I/Q Settings"](#), on page 414.
- **Physical signal connection** for the digital or analog I/Q signal
- For the most test setups, the instruments must use a **common reference frequency signal**.

Suitable reference frequency signal sources are:

- An external common reference source
- The distributed reference frequency of the R&S SMBV100B.

8.4.1.2 Test Setups

The test setup depends on the external instrument and the used I/Q output signal (digital, analog single-ended or analog differential).

8.4.1.3 Control of Connected External Instruments

For any connected external instruments, you find related information like the connection status and the used RF level and frequency values in the [External RF and I/Q](#) dialog. This dialog provides also additional short information on each of the connected instruments.

8.4.1.4 Overview of the Input and Output Signals and Interfaces

Designed as a signal generator with various application fields, the R&S SMBV100B uses a hardware concept that enables you to define and customize some of the input and output signals and interfaces. Depending on the configuration, digital interfaces can be used as input or output connectors. The different logical settings of the same physical interface are grouped in different dialogs.

Logical signals, streams and channels at the interfaces

This section provides **background information** and introduction to the topics. For an overview of the interfaces and their characteristics, refer to:

- ["Overview of the Baseband Signal Sources"](#) on page 408
- ["Overview of the RF Output Signals"](#) on page 408

- ["Important Signal Parameters and Interface's Characteristics"](#) on page 409

Overview of the Baseband Signal Sources

The [Table 8-1](#) gives an overview of the *possible* input signals and the connectors they are supplied at. Any one of the specified input signals can be processed by the I/Q modulator and output at the RF outputs.

Table 8-1: Physical input signals

Input Signal	Input connector Dig I/Q or HS Dig I/Q	GUI element	Refer to
Internal digital baseband signal	-	"Baseband"	Chapter 3, "Configuring the Internal Baseband Source" , on page 85
External digital signal	Dig I/Q HS Dig I/Q	"BB Input"	Chapter 8.6, "Digital Baseband Input Settings" , on page 426
External analog	I/Q	"I/Q Mod"	Chapter 5, "Applying I/Q Vector Modulation" , on page 251

Input interface for the external digital baseband signal

The two digital interfaces (Dig I/Q and HS Dig I/Q) can be used as input for digital signals but not at the same time. They provide direct communication with other Rohde & Schwarz instruments, like:

- Signal generators
- R&S FSW signal and spectrum analyzer

Application examples of the externally supplied digital baseband signal

Provided the instrument is equipped with the required options, the externally applied signals can be used for and further processed as follows:

- Used as a standalone baseband source and processed separately, e.g. detuned, or loaded with noise or directly applied to the I/Q modulator
- Used as a user-specific signals **instead of** the internally generated signal

Input interface for the external analog signal

The R&S SMBV100B provides also an input interface for an external wideband analog I/Q signal; the external signal is fed directly to the I/Q modulator.

For description of the related connectors and settings, see:

- [Chapter 5, "Applying I/Q Vector Modulation"](#), on page 251
- [Table 5-1](#).

Overview of the RF Output Signals

Usually, the generated baseband signal is modulated on the RF frequency and output at the RF connector. As shown in [Table 8-2](#), the R&S SMBV100B outputs the digitally modulated signal converted to an analog I/Q baseband output signal. The analog

baseband signal can be output single ended or differential (non-inverted); an RF envelope signal can be generated, too.

The [Table 8-2](#) shows the possible output connectors with the corresponding kind of signal.

Table 8-2: Physical output signals

Type	Output Signal	Output connector	GUI element	Refer to
RF	RF signal	RF	"RF"	Chapter 6, "Configuring the RF Signal", on page 260
	Analog signal <ul style="list-style-type: none"> • Single ended • Differential • RF Envelope 	<ul style="list-style-type: none"> • I/Q • I/Q Bar • I/I Bar 	"I/Q Analog"	Chapter 8.7, "I/Q Analog Output Settings", on page 435

Important Signal Parameters and Interface's Characteristics

The correct signal processing of the externally supplied input signals in the instrument and the correct processing of the output signal in the subsequently connected instrument require information of some signal parameters, like sampling rate, crest factor and signal level, expressed as peak or as RMS level value.

Sample rate

The sample rate of the digital input and output signal can be defined manually or automatically retrieved from the input and estimated for the output signal.

Crest factor

According to its definition, the crest factor gives the difference in level between the peak level and RMS level value in dB (see [Figure 8-3](#)).

The R&S SMBV100B uses the crest factor to calculate the power levels, that is the instrument compensates the RMS levels of the externally supplied signal by the crest factor. For example, the crest factor of the externally fed analog signal is important for the calculation of the RF output power.

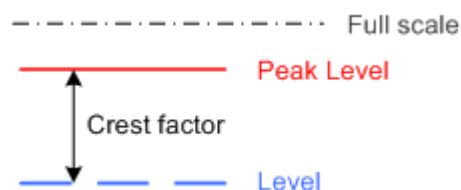

Figure 8-3: Relation between the level settings

Test setups often involve an up-converter connected to the analog or digital I/Q connectors of the generator or feeding of external signal to the digital input of the R&S SMBV100B. As a rule, whenever an I/Q signal is transferred between two instrument, *the crest factor and the peak levels of the two involved instruments have to be coordinated*. Proper signal settings and correct results are ensured if the peak level and crest factor values at the I/Q outputs of the "source" instrument (e.g. the R&S SMBV100B) and the I/Q inputs of the up-converter are equal.

In the R&S SMBV100B, level values are represented as relative to a full scale (see [Figure 8-3](#)).



Where to find the necessary values?

- Dialog "BB Input"
[Chapter 8.6, "Digital Baseband Input Settings"](#), on page 426
- Dialog "Analog I/Q Out"
See [Chapter 8.7, "I/Q Analog Output Settings"](#), on page 435

Why the instrument monitors the signal internally and how to avoid overflow

The R&S SMBV100B constantly monitors the input and output digital signal and indicates an overflow status.

- Overflow of the **input signal** (Crest Factor and Peak Level) is indicated if the entered "Peak Level" (in dB full scale) value does not correspond to the real value
Tip: The overflow status is indicated as long as the signal level is not reduced and the peak level value corrected. Trigger "Auto Level Set" to collect the required values and adjusts the settings automatically.
- Overflow of the **output signal** is indicated if the digital signal is clipped, i.e. if the level of the output signal, or the noise level (AWGN) are too high.

Specific Characteristics of the Digital I/Q Interface

What is a "digital channel" and how are the channels distributed to the basebands

The external digital signals supplied at the Dig I/Q interfaces of the instrument may contain more than one, possibly even multiplexed, digital channels. The R&S SMBV100B processes each of these digital channels as a separate signal.

Fulfilling the prerequisites for a correct signal processing of the externally supplied digital baseband signal

The ["Important Signal Parameters and Interface's Characteristics"](#) on page 409 emphasize why and which signal parameters are important for the correct internal signal processing of externally supplied signals in the R&S SMBV100B. This section focuses on the way these requirements are fulfilled and explains how the instrument deals with signals deviating from the expected values:

- **Crest factor, peak level and RMS level**

These values can be adjusted in one of the following ways:

- Adjusted manually
If you have knowledge about these values, it is best to enter them directly
- Estimated automatically by the internal measurement function
Use the function [Auto Level Set](#) to trigger the R&S SMBV100B to measure the input signal, estimate the peak level and RMS level and calculate the crest factor out of them.

Tip: For a correct signal leveling:

- 1) enable an appropriate measurement time
 - 2) perform one measurement for each baseband source
 - 3) set the measurement period to a time value that is long enough to capture several periods of the input signal.
- Determined automatically
- The R&S SMBV100B can receive the values from the connected transmitter. If the external digital signal source is a second Rohde & Schwarz instrument, it signals the peak level and the RMS level of the signal over the digital input interface. To enable the R&S SMBV100B to receive these values, enable the parameter "DIG IQ Auto Setting" on page 432.

In the second automatic way, the R&S SMBV100B adjusts the corresponding input fields with the measured/received values. The internal gain control mechanism uses these received values to adjust the input signal gain to achieve an optimal dynamic range.

- **Sample Rate**

External input signals with sample rates different than the system clock are resampled, as illustrated on [Figure 8-4](#).

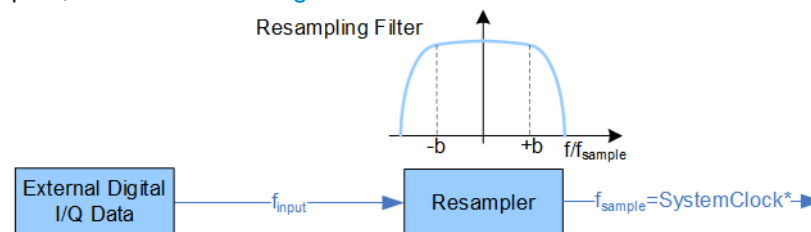

Figure 8-4: Resampling principle of external digital baseband signals

* = Max. sample rate depends on connected device

f_{input} = Max. sample rate

The R&S SMBV100B can process digital signals with sample rate $f_{input} = 400$ Hz to 200 MHz, where the maximum value ($f_{sample, max}$) depends on the capabilities of the connected transmitting/receiving device.

- **Maximum modulation bandwidth**

A baseband signal with a sample rate $f_{sample} < f_{sample, max}$ (i.e. smaller than the used system clock) is interpolated, see [Figure 8-4](#). The resulting modulation bandwidth is calculated as *Sample Rate* * 0.8.

With a sample rate $f_{sample, max}$ of exactly 600 MSamples/s, the modulation bandwidth is 160 MHz.



Estimating or defining the sample rate

The sample rate of the signal at the digital interface can be determined with one of the following methods:

- **Estimated sample rate**
Enable the instrument to evaluate the received I/Q data clock
- **User-defined sample rate**
Provide both the external signal source and the receiving instrument with a common external reference signal and set the sample rate value.

Specifics of the Analog I/Q Interfaces

The R&S SMBV100B outputs the digitally modulated signal not only directly but also converted to an analog I/Q baseband output signal. The R&S SMBV100B outputs the analog baseband signal single ended or differential (non-inverted); an RF envelope signal can be generated, too.

Differential output signal

The differential output provides symmetrical signals for differential inputs of DUTs without the need of additional external electric network. To achieve an optimal and balanced operating point of these inputs, ensure the correct adjustment of the used DC voltage ("Bias") and the offset ("Offset") between inverting and non-inverting output. Refer to the descriptions [Bias \(EMF\)](#) and [Offset \(EMF\)](#) for a description of the effect of these parameters.

Maximum overall output voltage

The voltage of the analog output signals is defined as a combination of output voltage of the I and Q signal components and an optional bias voltage. If the differential output is used, an additional offset can be set, too. The values of these parameters are interdependent so that the magnitude of the sum of output voltage and bias voltage must not exceed 4V.

The following applies:

- Single ended signal:
 $V_p + V_{bias} \leq 4 \text{ V}$
- Differential signal:
 $0.5 \cdot V_p + |V_{bias}| + 0.5 \cdot V_{offset} \leq 4 \text{ V}$

Where:

- V_p is the output voltage as set with the parameter [I/Q Level Vp EMF](#)
- V_{bias} is the bias voltage as set with the parameter [Bias \(EMF\)](#)
- V_{offset} is the offset between inverting and non-inverting output as set with the parameter [Offset \(EMF\)](#)

8.4.1.5 Further Information

For description of the settings related to connection establishment, see:

- [Chapter 8.5.2, "External RF and I/Q Settings"](#), on page 414
- [Chapter 8.5.1, "I/Q Stream Mapper Settings"](#), on page 414

For information on the **manual and remote control operation** of the external instruments, see the documentation of the particular instrument:

- For R&S SGT, see the SGT100A User Manual

8.5 System Configuration Settings

The settings in this dialog comprise the I/Q mapping and the processing of the generated I/Q streams. From this dialog, you can control and configure the connections to instruments connected to the RF and I/Q connectors.

Required options

The equipment layout includes:

- Base unit
- Option differential analog I/Q outputs R&S SMBVB-K17
- Optional, option frequency R&S SMBVB-B10/-KB106

Settings:

For description of the "Multi-Instrument" settings, see [Chapter 8.3.1.1, "Multi-Instrument Settings"](#), on page 400.

This section described the following settings:

- [I/Q Stream Mapper Settings](#).....414
- [External RF and I/Q Settings](#)..... 414
- [Overview](#)..... 426

8.5.1 I/Q Stream Mapper Settings

Access:

- In the block diagram, select "I/Q Stream Mapper".



The dialog provides the settings for routing of the signal streams to the available output connectors.

Settings:

Frequency Offset.....	414
Phase Offset.....	414
Map Stream X to Connector.....	414

Frequency Offset

Sets an absolute frequency offset f_{offset} .

Tip: Use this parameter to shift the used frequency band in the RF frequency section without modifying the RF settings.

Phase Offset

Sets the phase offset of the corresponding stream.

Map Stream X to Connector

The mapping of the generated stream to the output connectors is represented as a stream matrix. A blue circle at a matrix element routes the stream to the selected connector.

Remote command:

`:SCONfiguration:OUTPut:MAPPING:RF:STReam<st>:STATe` on page 636

`:SCONfiguration:OUTPut:MAPPING:IQOutput:STReam<st>:STATe`

on page 636

8.5.2 External RF and I/Q Settings

With the settings in the "External RF and I/Q" tab, you can control external devices and instruments from the R&S SMBV100B, if all prerequisites are fulfilled. See "[Prerequisites for control of external instruments from the R&S SMBV100B](#)" on page 415.



Prerequisites for control of external instruments from the R&S SMBV100B

The following connections between the R&S SMBV100B and the external instruments are required:

- **Physical remote control connection** over LAN or USB
The remote control connection to the external instruments must be in status **connected**, see [Remote Connection Status](#).
- **Physical signal connection** for the digital or analog I/Q signal
- For the most test setups, the instruments must use a **common reference frequency signal**.

Suitable reference frequency signal sources are:

- An external common reference source
- The distributed reference frequency of the R&S SMBV100B.

Access:

- ▶ Select "Taskbar > System Config > System Configuration > External RF and I/Q".

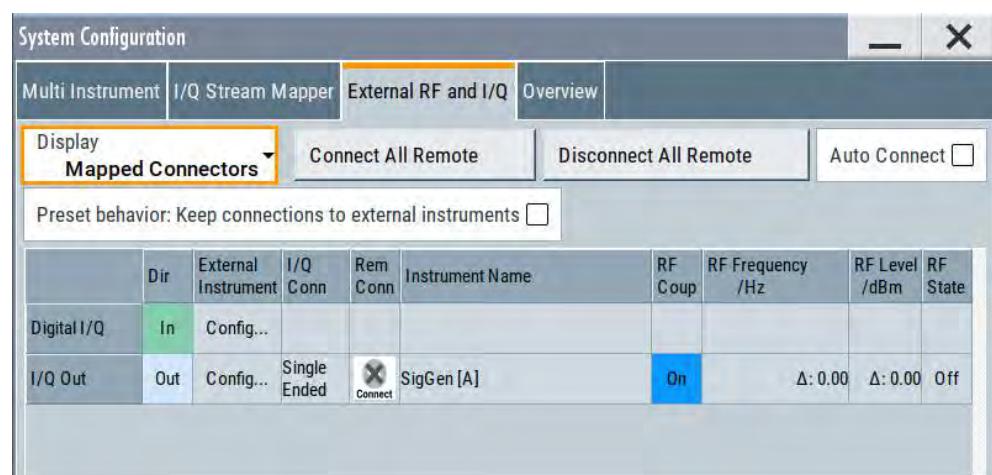

The dialog provides an overview of all available I/Q input and output connectors and comprises the settings necessary to establish the connection to the external instruments. Displayed is an overview of the currently connected external instruments together with relevant information like the connection status and the RF level and frequency these external instruments use.

The dialog provides access to some additional short information on each of the connected instruments. It also provides a show connector function for an easy localization of the selected connector on the instrument front or rear panel.

Settings:

- [Connections Configuration and Connection Status Overview Settings](#)..... 416
- [External Instrument Configuration Settings](#).....420

8.5.2.1 Connections Configuration and Connection Status Overview Settings

Access:

- ▶ Select "Taskbar > System Config > System Configuration > External RF and I/Q".

Settings:

Display.....	416
Auto Connect.....	416
Connect/Disconnect All Remote.....	417
Preset behavior: Keep connections to external instruments.....	417
Connector Name.....	417
Direction.....	417
External Instrument.....	418
I/Q Connection.....	418
Remote Connection Status.....	418
Instrument Name.....	419
RF Couple.....	419
(Delta) RF Frequency/ RF Level.....	419
RF State.....	420

Display

Filters the displayed connectors upon one of the following criteria:

"All Connectors"

No filter is applied.

"Mapped Connectors"

Displayed are only the connectors to which a stream is mapped.

Note: To prevent faults, use this filter before you further configure the external instruments.

"Input Connectors/Output Connectors"

Filters the display according to connector direction.

Remote command:

:SCONfiguration:EXTernal:DISPlay on page 637

Auto Connect

With enabled auto connect function, the instrument automatically detects connected external instruments and establishes the required connection.

If the "Auto Connect > Off", however, after a R&S SMBV100B startup you have to revise the test setup and perform the following:

- Check whether the necessary connections between the R&S SMBV100B and the external instruments are still existing.
- Prove that the remote control of the particular instruments is required.
- Trigger the [Connect All Remote](#) function.

Remote command:

:SCONfiguration:EXTernal:ACONnect on page 637

Connect/Disconnect All Remote

Triggers the instrument to:

- Establish the remote connections to all configured [External Instruments](#).
- To terminate all existing remote connections.
The external instruments are not removed from the list of external instruments.
Only the remote connection status changes.

Remote connection status can be toggled with the parameter [Remote Connection Status](#).

Note:

External instruments connected to the R&S SMBV100B are preset (`:DEVIce:PRESet`) whenever:

- The connection to the external instrument is established or terminated ("Connect/Disconnect All Remote" or "Rem. Conn > On/Off")
- The R&S SMBV100B is preset ([Preset]).

To ensure that the remote connections to the external instruments will be automatically established after instrument's start-up or a reboot, set [Auto Connect](#) > "On".

Remote command:

`:SCONfiguration:EXTernal:REMOte:CONNect[:ALL]` on page 638

`:SCONfiguration:EXTernal:REMOte:DISConnect[:ALL]` on page 638

Preset behavior: Keep connections to external instruments

Sets the effect of R&S SMBV100B preset ([Preset] or *RST) on the following:

- The connection status between the instrument and the connected external instruments.
- The R&S SMBV100B itself and the preset values.
- The connected instruments.

"Preset behavior..."	Off	On
R&S SMBV100B and preset values	Standard R&S SMBV100B preset See Table 9-1 .	Standard R&S SMBV100B preset Excluded from preset: <ul style="list-style-type: none"> • "I/Q Output Type" See also
Connection status	Terminated ("Disconnect All Remote")	Unchanged
Connected instruments	External instrument preset (<code>:DEVIce:PRESet</code>)	External instrument preset

Remote command:

`:SCONfiguration:EXTernal:PBEHaviour` on page 638

Connector Name

Displays the connector name.

Remote command:

via keyword in the SCPI syntax, e.g. IQOutput

Direction

Displays the connector direction as a color coded field.

Remote command:

`:SCONfiguration:EXTeRnal:DIgital:DIRection?` on page 639

`:SCONfiguration:EXTeRnal:IQOutput:DIRection?` on page 639

External Instrument

Accesses a dialog with settings that help you to establish the connection to the external instruments, see [Chapter 8.5.2.2, "External Instrument Configuration Settings"](#), on page 420.

Note:



Each external instrument must be connected via a LAN or USB to the R&S SMBV100B.

In most test setups, all instruments must use a common reference frequency signal, either from an external common reference source or using the distributed reference frequency of the R&S SMBV100B.

I/Q Connection

Depends on the interface type.

- Analog I/Q interfaces:
Selects the type of the I/Q output signal
- Digital I/Q interfaces:
Indicates the status of the I/Q connection of the digital interfaces.

Indication		Designation
A green LED and an icon		The Dig I/Q interface is used as an input connector
A yellow LED and an icon		The Dig I/Q interface is used as an output connector
An icon without an LED		An external instrument is connected to the Dig I/Q interface, but no direction is specified
No icon displayed		No connection
"Single Ended"/	"Differential"	Selects the type of the I/Q output signal at the I/Q output connector Works like the parameter " I/Q Output Type " on page 439.

Remote command:

`:SCONfiguration:EXTeRnal:DIgital:IQConnection:STATe?` on page 639

`[:SOURce<hw>] :IQ:OUTPut [:ANALog] :TYPE` on page 827

Remote Connection Status

Indicates the status of the remote connection. Click the status indicator to toggle the remote connection status.

To connect/disconnect all external instruments, use the functions [Connect/Disconnect All Remote](#).

Note:

External instruments connected to the R&S SMBV100B are preset (`:DEVIce:PRESet`) whenever:

- The connection to the external instrument is established or terminated ("Connect/ Disconnect All Remote" or "Rem. Conn > On/Off")
- The R&S SMBV100B is preset ([Preset]).

Note: An active "Rem. Conn." and an "RF State > On" do not mean that an I/Q stream is mapped to this connector.

Use the "System Configuration > External Rf and I/Q > Display > Mapped Connectors" filter to list only the connectors with a mapped I/Q stream.

Remote command:

`:SCONfiguration:EXTernal:DIGital:RCONnection:STATe?` on page 640
`:SCONfiguration:EXTernal:DIGital:REMote:DISConnect` on page 646
`:SCONfiguration:EXTernal:IQOutput:RCONnection:STATe?` on page 640
`:SCONfiguration:EXTernal:IQOutput:REMote:DISConnect` on page 646
`:SCONfiguration:EXTernal:DIGital:REMote:INFO?` on page 645
`:SCONfiguration:EXTernal:IQOutput:REMote:INFO?` on page 645

Instrument Name

Displays useful information on the connected external instrument, like the instrument designation and the RF path the RF settings are coupled to.

Remote command:

`:SCONfiguration:EXTernal:DIGital:INAME?` on page 640
`:SCONfiguration:EXTernal:IQOutput:INAME?` on page 640
`:SCONfiguration:EXTernal:DIGital:REMote:INFO?` on page 645
`:SCONfiguration:EXTernal:IQOutput:REMote:INFO?` on page 645

RF Couple

If enabled, this parameter couples all major RF setting (like the "RF Frequency", the "RF Level" and the "RF State") of the external instrument to the R&S SMBV100B.

The R&S SMBV100B acts as a "master", i.e the external instruments synchronize their settings and the RF output state to the R&S SMBV100B. You can apply delta frequency and level offset to the signal.

Remote command:

`:SCONfiguration:EXTernal:DIGital:RF:COUPling` on page 640
`:SCONfiguration:EXTernal:IQOutput:RF:COUPling` on page 640

(Delta) RF Frequency/ RF Level

In uncoupled mode, sets the RF frequency and RF level of the external instrument.

With enabled "RF Coupled" parameter, applies a frequency and level offset. The RF frequency of the external instrument is calculated as follows:

$$RF_{ExtInstr} = RF_{Instrument} + \Delta_{Freq}$$

Where both the RF frequency and the frequency offset are applied at the external instrument.

Remote command:

`:SCONfiguration:EXTernal:DIGital:RF:FREQuency` on page 641
`:SCONfiguration:EXTernal:IQOutput:RF:FREQuency` on page 641

:SCONfiguration:EXTernal:DIGital:RF:FREQuency:OFFSet on page 641
 :SCONfiguration:EXTernal:IQOutput:RF:FREQuency:OFFSet on page 641
 :SCONfiguration:EXTernal:DIGital:RF:POWer on page 641
 :SCONfiguration:EXTernal:IQOutput:RF:POWer on page 641
 :SCONfiguration:EXTernal:DIGital:RF:POWer:OFFSet on page 642
 :SCONfiguration:EXTernal:IQOutput:RF:POWer:OFFSet on page 642

RF State

With enabled "RF Coupled" parameter, displays the RF output state of the connected external instrument. The parameter is coupled to the state of the RF output of the R&S SMBV100B.

In uncoupled mode, enables/disables the RF output in the external instrument.

Remote command:

:SCONfiguration:EXTernal:DIGital:RF:STATe on page 642
 :SCONfiguration:EXTernal:IQOutput:RF:STATe on page 642

8.5.2.2 External Instrument Configuration Settings

Access:

1. Select "Taskbar > System Config > System Configuration > External RF and I/Q".
2. Navigate to the required connector.
Select "External Instruments > Config ...".

The "<Dig. Conn. Name>: External Instrument Configuration" dialog opens and displays the "External Instrument Configuration > Remote Config" settings.

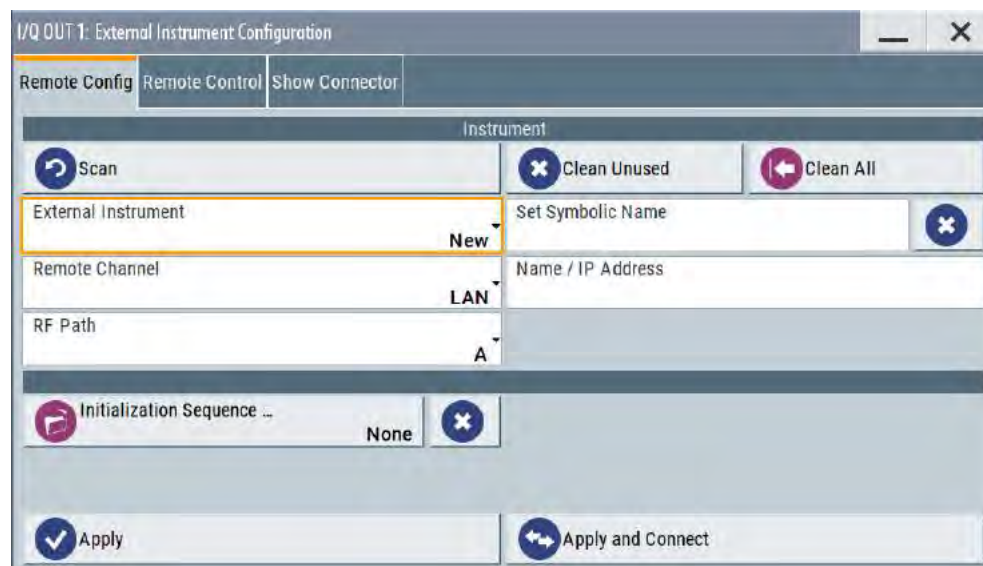

Settings:

Remote Config Settings.....	421
Remote Control Settings.....	424
Show Connector.....	425

Remote Config Settings

Access:

- ▶ Select "Taskbar > System Config > System Configuration > External RF and I/Q > External Instruments > Config ...".

Settings:

Detect/Scan.....	421
Clean Unused/Clean All.....	422
External Instrument.....	422
Set Symbolic Name.....	422
Remote Channel.....	422
Name / IP Address.....	423
RF Path.....	423
Initialization Sequence.....	423
Remove Initialization Sequence.....	423
Apply.....	423
Apply and Connect.....	423

Detect/Scan

If you connect an external instrument, you can fill in the required information in the "External Instrument Configuration" dialog manually or use one of the provided "Detect/Scan" functions. Both functions consider the connections via the supported interfaces, USB or LAN.

The parameter [External Instrument](#) lists the pool of available instruments.

Scans the network for connected supported instruments, like:

R&S SGS or R&S SGT.

Note: The scan function searches throughout the entire network and can last several minutes.

Note: The first initialization of an instrument connected to a network can last several minutes. During their initialization, instruments are not detected by the detect/scan function.

"Detect" Searches for external instruments connected to this particular digital interface of the R&S SMBV100B.

Remote command:

:SCONfiguration:EXTernal:DIGital:REMote:DETECT? on page 644

"Scan" Scans the network for connected supported instruments, like:
R&S SGS or R&S SGT.

Note: The scan function searches throughout the entire network and can last several minutes.

Remote command:

`:SCONfiguration:EXTernal:REMote:SCAN` on page 643

`:SCONfiguration:EXTernal:REMote:SCAN:STATe?` on page 643

Clean Unused/Clean All

Triggers the instrument to clean at once all unused LAN connections. This function allows you to retrieve a new pool of valid instruments.

The "Clean All" function removes all configured settings from the "External RF and I/Q". USB connections to external instruments are not affected.

Remote command:

`:SCONfiguration:EXTernal:REMote:PURGe` on page 646

`:SCONfiguration:EXTernal:REMote:CLEan` on page 647

External Instrument

Lists all available instruments, found by the [Detect/Scan](#) function.

To connect an external instrument, use one of the following:

- Enable "Select Instrument > New" and configure the settings manually
- Select "Select Instrument", navigate through the pool of available instruments, and select the required. The required settings are retrieved and updated automatically.

Select "None" to disable the connection.

Execute "Apply" to confirm the settings.

Remote command:

`:SCONfiguration:EXTernal:REMote:LIST?` on page 643

`:SCONfiguration:EXTernal:REMote:ADD` on page 643

`:SCONfiguration:EXTernal:DIGital:REMote:ISElect` on page 645

`:SCONfiguration:EXTernal:IQOutput:REMote:ISElect` on page 645

Set Symbolic Name

Sets the alias name of the instrument.

Remote command:

`:SCONfiguration:EXTernal:REMote:ADD` on page 643

`:SCONfiguration:EXTernal:DIGital:REMote:INFO?` on page 645

`:SCONfiguration:EXTernal:IQOutput:REMote:INFO?` on page 645

Remote Channel

Selects the hardware channel (USB or LAN) used by the remote channel to the external instrument.

Remote command:

`:SCONfiguration:EXTernal:REMote:ADD` on page 643

`:SCONfiguration:EXTernal:DIGital:REMote:INFO?` on page 645

`:SCONfiguration:EXTernal:IQOutput:REMote:INFO?` on page 645

Name / IP Address

Displays/sets the IP address or hostname of the connected external instrument.

Remote command:

`:SCONfiguration:EXTernal:REMOte:ADD` on page 643
`:SCONfiguration:EXTernal:DIGital:REMOte:INFO?` on page 645
`:SCONfiguration:EXTernal:IQOutput:REMOte:INFO?` on page 645

RF Path

In a two-path instrument, determines the RF output to be used.

Remote command:

`:SCONfiguration:EXTernal:REMOte:ADD` on page 643
`:SCONfiguration:EXTernal:DIGital:REMOte:INFO?` on page 645
`:SCONfiguration:EXTernal:IQOutput:REMOte:INFO?` on page 645

Initialization Sequence

Accesses the standard "File Select" dialog for loading an existing initialization file (extension *.iec).

When you establish the connection to an external instrument, i.e. [Remote Connection Status](#) is active, the R&S SMBV100B performs the following:

- Sends the command `:DEVIce:PRESet`
- Sends the content of the initialization sequence file to reconfigure the external instrument

If necessary, perform further settings and configuration of the external instruments.

Remote command:

`:SCONfiguration:EXTernal:REMOte:INITialization:USER:CATalog?`
on page 646
`:SCONfiguration:EXTernal:DIGital:REMOte:INITialization:FILE`
on page 646
`:SCONfiguration:EXTernal:IQOutput:REMOte:INITialization:FILE`
on page 646

Remove Initialization Sequence

Deletes the loaded sequence.

Apply

Confirms the settings and displays the external instrument in the "External RF and I/Q" dialog.

Remote command:

`:SCONfiguration:EXTernal:DIGital:REMOte:ISElect` on page 645
`:SCONfiguration:EXTernal:IQOutput:REMOte:ISElect` on page 645

Apply and Connect

Confirms the settings and triggers the connection establishment. In the connected instruments, the status of this active remote connection is displayed by the "Remote" indication.

Remote command:

:SCONfiguration:EXTernal:DIGital:REMOte:ISElect on page 645

:SCONfiguration:EXTernal:DIGital:REMOte:CONNect on page 645

:SCONfiguration:EXTernal:IQOutput:REMOte:ISElect on page 645

:SCONfiguration:EXTernal:IQOutput:REMOte:CONNect on page 645

Remote Control Settings

Access:

1. Select "Taskbar > System Config > System Configuration > External RF and I/Q".
2. Navigate to the required connector.
Select "External Instruments > Config ...".
3. In the "<Dig. Conn. Name>: External Instrument Configuration" dialog, select "Remote Control".

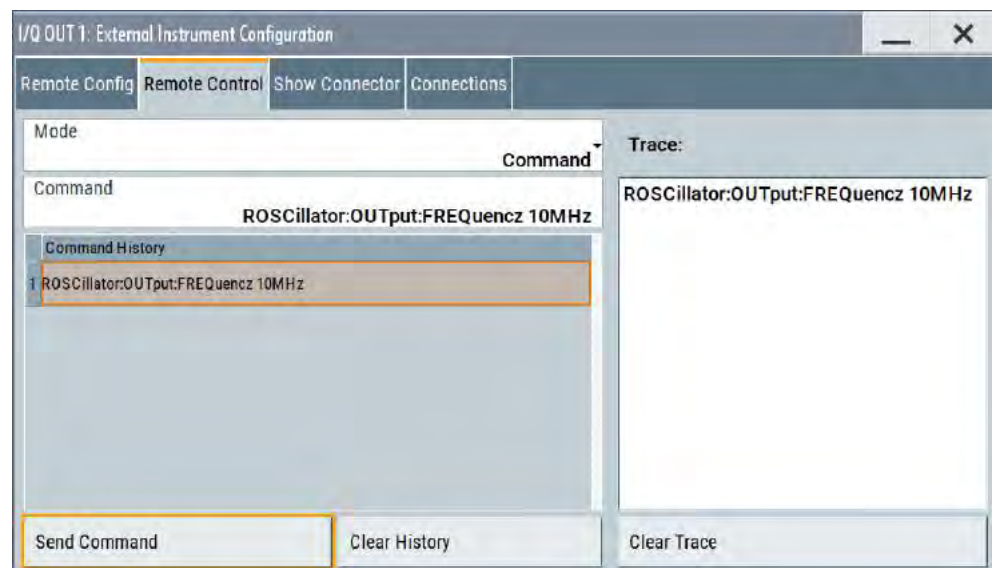

In this dialog, you can send individual SCPI commands or a sequence of SCPI commands to the connected instruments.

The sent commands and their results are displayed in the "Command Trace" field, as long as the trace is not deleted "Clear Trace". The sent commands are also listed in the "History" list. As long as this history list is not deleted ("Clear History"), you can select a command from the list and send it again.

Settings:

Mode.....	425
Command, Send Command.....	425
File, Sequence, Send Sequence.....	425
History, Clear History.....	425
Commands Trace, Clear Trace.....	425

Mode

You can send a single command ("Command") or a command sequence ("Sequence") to the connected instrument.

Command, Send Command

Entry field for the SCPI commands.

You can enter a new command or select a previously sent command from the "History".

If the remote connection is active, select "Send Command" to execute the command.

File, Sequence, Send Sequence

Accesses the standard "File Select" dialog for loading of user-defined files with extension *.iec.

The provided navigation possibilities in the dialog are self-explanatory.

When a file is selected, its name and content are displayed, and the first command is selected. You can send the commands one by one ("Send Command") or send the entire sequence at once ("Send Sequence").

After a command is sent, the next command from the sequence is selected.

See also:

- ["Initialization Sequence"](#) on page 423
- [Chapter 9.5.1, "File Select Settings"](#), on page 458.

History, Clear History

List of the sent commands.

As long as this history list is not cleared ("Clear History"), you can select a command from the list and send it again.

Commands Trace, Clear Trace

List of the sent commands and their results, where the results are displayed in blue color.

To delete the trace, select "Clear Trace".

Show Connector

Access:

1. Select "Taskbar > System Config > System Configuration > External RF and I/Q".
2. Navigate to the required connector.
Select "External Instruments > Config ...".
3. In the "<Dig. Conn. Name>: External Instrument Configuration" dialog, select "Show Connector".

The dialog displays the location of the selected connector.

The "Show Connector" function triggers the instrument to identify the connector on the rear panel. The LED next to the selected connector blinks.

8.5.3 Overview

Access:

- ▶ To display an *interactive* overview diagram of the current configuration, select "System Configuration > Overview".

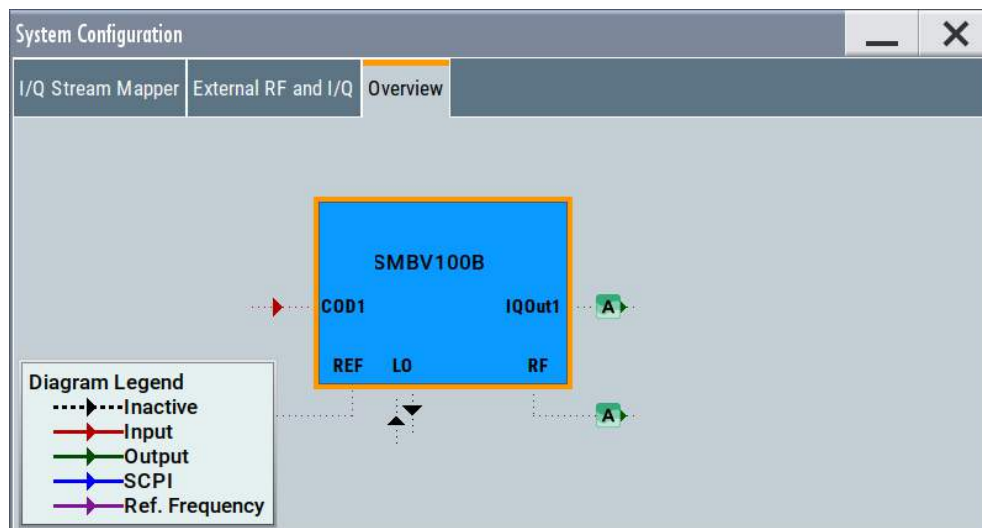

The overview tab shows information on the following:

- Current stream mapping to the output interfaces
See [Chapter 8.5.1, "I/Q Stream Mapper Settings"](#), on page 414.
- Connected controller (external PC).
See [Chapter 8.5.2, "External RF and I/Q Settings"](#), on page 414.
- Connections for remote control of connected external I/Q and RF devices
- Input and output signals, like:
 - LO coupling or used external reference frequency.
 - Connected external baseband source to the digital input interface.

Hotspots for fast access to the required settings

Several of the displayed elements are hotspots. Select an element to access the related dialog.

8.6 Digital Baseband Input Settings

The R&S SMBV100B provides interfaces to feed an **external digital baseband signal** into the signal path.



This function will be supported in a future firmware version.

The "Baseband Input" cannot be activated. However, the baseband input related settings in the "Baseband Input" or "System configuration > External RF and I/Q" are displayed and described, as are the respective remote control commands.

These settings have no effect because the baseband input interfaces cannot be activated.

Required Options

The equipment layout for applying an external baseband signal includes:

- Base unit
(incl. the digital interfaces Dig I/Q and HS Dig I/Q, where each of the interfaces can be used as input or output)
- Option frequency R&S SMBVB-B103

For more information, see data sheet.

To access and configure the "Baseband Input" settings

The **"BB Input"** block provides access to the settings for frequency offset and path gain, and to the available configuration parameters of the external signal.

The digital baseband input interface **Dig I/Q** and **HS Dig I/Q** are located on the R&S SMBV100B rear panel, see ["Overview of the Baseband Signal Sources"](#) on page 408.

In the default instrument state, the block diagram displays the connector in an unfolded state. The digital input interface is inactive.

1. To display the **"BB Input"** block if the connectors are folded, select the connector symbol "HS Dig I/Q In".

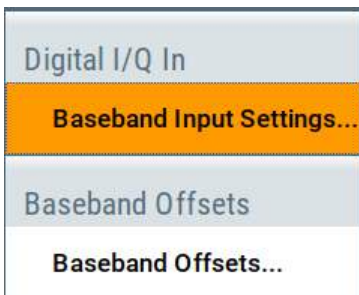

Figure 8-5: Representation of the digital baseband input interface HS Dig I/Q

1 = Digital input interface state: gray = inactive; blue = active
2 = Connector name

2. To access the frequency offset settings, select "BB Input > Baseband Offsets". See [Chapter 3.10, "Shifting and Boosting the Baseband Signal"](#), on page 224.
3. To access the dialog box for configuring the external signal input, select "BB Input > Digital I/Q In > Baseband Input Settings".

The "Baseband Input Settings" dialog provides settings necessary to define the used connector, and to adjust the signal parameters, like the sample rate and the baseband input level.



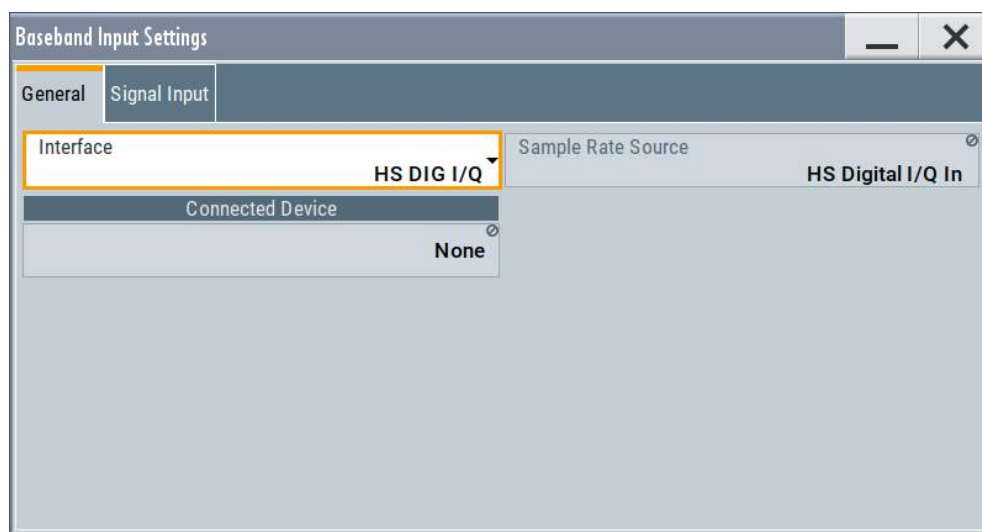

In this dialog, you access the **settings of both, the Dig I/Q and the HS Dig I/Q connectors** in the same manner. You recognize the type of connector that is active by the used **connector icon**.

4. To set the input connector, select "BB Input > General > Interface > HS Dig I/Q"
5. To enable the input signal:
 - Select "BB Input > On" or
 - Select "BB Input > Baseband Input Settings > State > On".



The internal baseband generator ("Baseband" block) and the external digital baseband input ("BB Input") cannot be activated simultaneously. They deactivate each other.

The remote commands required to define these settings are described in [Chapter 12.16.2, "SOURCE:BBIN Subsystem"](#), on page 652.

Settings:

- [General Settings](#)..... 428
- [Signal Input Settings](#)..... 430
- [Sample Rate Settings](#)..... 433
- [Input Level Settings](#)..... 434

8.6.1 General Settings

Access:

- ▶ Select "BB Input > Digital I/Q In > Baseband Input Settings".

**Settings:**

State.....	429
Interface.....	429
Sample Rate Source.....	429
Connected Device.....	430

State

Note: This function will be supported in a future firmware version.

The "Baseband Input" cannot be activated. However, the baseband input related settings in the "Baseband Input" or "System configuration > External RF and I/Q" are displayed and described, as are the respective remote control commands.

These settings have no effect because the baseband input interfaces cannot be activated.

Enables the feeding of the selected external digital signals into the baseband.

Note: The internal baseband generator ("Baseband" block) and the external digital baseband input ("BB Input") cannot be activated simultaneously. They deactivate each other.

Remote command:

[:SOURce<hw>] :BBIN:STATe on page 654

Interface

Indicates the used digital interface.

Sets which of the digital interfaces is used, the Dig I/Q or the HS Dig I/Q.

Remote command:

[:SOURce<hw>] :BBIN:DIGital:INTerface on page 654

Sample Rate Source

Indicates the digital interface used to estimate the sample rate.

"Digital I/Q In"

Estimates the sample rate based on the applied I/Q data clock and displays the resulting value in the value field. The I/Q data clock signal is fed via the Dig I/Q input.

Note: Estimation works best if the sample rate is close to the user-defined value.

"HS Digital I/Q In"

Estimates the sample rate value based on the information transmitted by the transmitter.

Resulting value per channel is displayed by the parameter [Sample Rate](#).

Remote command:

[\[:SOURce<hw>\]:BBIN:SRATe:SOURce](#) on page 657

Connected Device

If the connection to the external device is properly established and signal transmission is active, this parameter displays information on the instrument connected to the Dig I/Q interface:

- Name and serial number of the connected instrument
- The transmitter sample rate, if supported by the transmitter

"None" indicates that no device is connected.

Remote command:

[\[:SOURce<hw>\]:BBIN:CDEvice?](#) on page 659

8.6.2 Signal Input Settings

Access:

1. Select "BB Input > Digital I/Q In > Baseband Input Settings > Interface = HS DIG I/Q".
2. Select "Signal Input".



Settings:

Channel Table..... 431

- L Number..... 431
- L Name..... 431
- L Sample Rate..... 432
- L Crest Factor..... 432
- L Peak Level..... 432
- L Level..... 432
- L BB..... 432

Aggregated Link Sample Rate..... 432

DIG IQ Auto Setting..... 432

Measurement Period..... 433

Auto Level Set..... 433

Channel Table

Displays information on the up to 8 digital channels per HS Dig I/Q interface:

Number ← Channel Table

Subsequent number.

Name ← Channel Table

Channel indication, retrieved from the digital interface.

Remote command:

[:SOURce<hw>] :BBIN:CHANnel<ch0>:NAME on page 655

Sample Rate ← Channel Table

Indicates the used sample rate per channel.

For information on the max. sample rate and the aggregated sample rate, depending on the number of active channels, observe the indication [Aggregated Link Sample Rate](#).

Remote command:

`[:SOURce<hw>] :BBIN:CHANnel<ch0>:SRATe` on page 656

Crest Factor ← Channel Table

If [DIG IQ Auto Setting](#) > "Off", sets the crest factor per channel.

Remote command:

`[:SOURce<hw>] :BBIN:CHANnel<ch0>:POWER:CFACtor` on page 655

Peak Level ← Channel Table

If [DIG IQ Auto Setting](#) > "Off", sets the peak level per channel. The value is set relative to full scale of 0.5 V (in terms of dB full scale).

Remote command:

`[:SOURce<hw>] :BBIN:CHANnel<ch0>:POWER:PEAK` on page 655

Level ← Channel Table

Indicates the estimated RMS level acquired with "Auto Level Set".

Remote command:

`[:SOURce<hw>] :BBIN:CHANnel<ch0>:POWER:RMS` on page 656

BB ← Channel Table

Activates the channel. Only one channel can be activated at a time. Toggle the state of the channel to test all of them subsequently.

Remote command:

`[:SOURce<hw>] :BBIN:CHANnel<ch0>:BB:STATe` on page 655

Aggregated Link Sample Rate

Indicates the aggregated sample rate and the maximum sample rate, where:

- The aggregated sample rate is the sum of the sample rates of all active channels. It can not exceed the maximum sample rate.
- The R&S SMBV100B supports two standard max. sample rate values. This parameter indicates the currently selected one, where the max. sample rate is selected depending on the capabilities of the transmitter.

For more information, see data sheet.

Remote command:

`[:SOURce<hw>] :BBIN:SRATe:SUM?` on page 656

`[:SOURce<hw>] :BBIN:SRATe:MAX?` on page 656

DIG IQ Auto Setting

Activates an automatic adjustment of the baseband input signal.

The R&S SMBV100B receives PEP, level and crest factor values directly from the connected transmitter and recognizes changes automatically.

Remote command:

[\[:SOURce<hw>\]:BBIN:DIGital:ASETting:STATe](#) on page 657

Measurement Period

Sets the recording duration for measuring the baseband input signal by "Auto Level Set".

Note: For accurate level measurements, set the measurement period to a time value that is long enough to capture several periods of the input signal.

Remote command:

[\[:SOURce<hw>\]:BBIN:MPERiod](#) on page 658

Auto Level Set

Starts measuring the input signal for estimating the crest factor, the peak power, and the RMS power of the input signal.

See also ["Fulfilling the prerequisites for a correct signal processing of the externally supplied digital baseband signal"](#) on page 410.

Remote command:

[\[:SOURce<hw>\]:BBIN:ALEVel:EXECute](#) on page 658

8.6.3 Sample Rate Settings

Access:

1. Select "BB Input > Digital I/Q In > Baseband Input Settings > Interface = DIG I/Q".
2. Select "Sample Rate".



[Sample Rate Source](#)..... 433

[Sample Rate Value](#)..... 434

Sample Rate Source

Indicates the digital interface used to estimate the sample rate.

"Digital I/Q In"

Estimates the sample rate based on the applied I/Q data clock and displays the resulting value in the value field. The I/Q data clock signal is fed via the Dig I/Q input.

Note: Estimation works best if the sample rate is close to the user-defined value.

"HS Digital I/Q In"

Estimates the sample rate value based on the information transmitted by the transmitter.

Resulting value per channel is displayed by the parameter [Sample Rate](#).

Remote command:

`[:SOURce<hw>] :BBIN:SRATe:SOURce` on page 657

Sample Rate Value

For Dig I/Q connectors, sets the sample rate of the external digital baseband input signal.

The max. sample rate depends on the connected transmitting device.

Remote command:

`[:SOURce<hw>] :BBIN:SRATe [:ACTual] ?` on page 657

8.6.4 Input Level Settings

Access:

1. Select "BB Input > Digital I/Q In > Baseband Input Settings > Interface = DIG I/Q".
2. Select "Input Level".

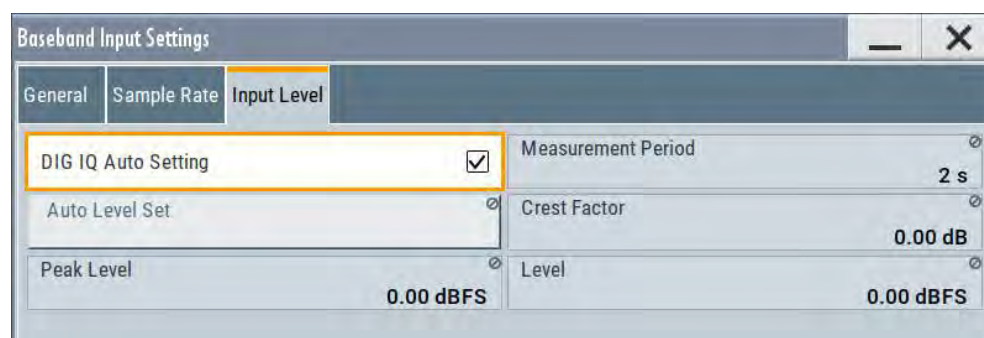

DIG IQ Auto Setting	434
Measurement Period	435
Auto Level Set	435
Crest Factor	435
Peak Level	435
Level	435

DIG IQ Auto Setting

Activates an automatic adjustment of the baseband input signal.

The R&S SMBV100B receives PEP, level and crest factor values directly from the connected transmitter and recognizes changes automatically.

Remote command:

`[:SOURce<hw>] :BBIN:DIGital:ASETting:STATe` on page 657

Measurement Period

Sets the recording duration for measuring the baseband input signal by "Auto Level Set".

Note: For accurate level measurements, set the measurement period to a time value that is long enough to capture several periods of the input signal.

Remote command:

[:SOURce<hw>] :BBIN:MPERiod on page 658

Auto Level Set

Starts measuring the input signal for estimating the crest factor, the peak power, and the RMS power of the input signal.

See also "Fulfilling the prerequisites for a correct signal processing of the externally supplied digital baseband signal" on page 410.

Remote command:

[:SOURce<hw>] :BBIN:ALEVel:EXECute on page 658

Crest Factor

Indicates the crest factor of the external baseband signal.

See also "Important Signal Parameters and Interface's Characteristics" on page 409.

Remote command:

[:SOURce<hw>] :BBIN:POWer:CFACTOR on page 658

Peak Level

Indicates the peak level of the external baseband signal relative to full scale of 0.5 V (in terms of dB full scale).

See also "Important Signal Parameters and Interface's Characteristics" on page 409.

Remote command:

[:SOURce<hw>] :BBIN:POWer:PEAK on page 658

Level

Indicates the estimated RMS level acquired with "Auto Level Set".

Remote command:

[:SOURce<hw>] :BBIN:POWer:RMS? on page 659

8.7 I/Q Analog Output Settings

Required Options

The equipment layout for output of analog I/Q signal includes:

- Base unit
Incl. output the baseband signal at the single-ended outputs
- Option differential analog I/Q outputs (R&S SMBVB-K17)

Access

The analog output connectors I/Q are located on the R&S SMBV100B rear panel, see "[Overview of the RF Output Signals](#)" on page 408.

The block diagram displays the "I/Q OUT" connector in a folded state. The analog output connectors are inactive (gray LEDs).



Figure 8-6: Representation of the analog output interface

- 1 = Analog output interface state: gray = inactive; blue = active
- 2 = Mapped I/Q stream
- 3 = Analog output connector name

To configure the "I/Q Analog Output" settings

1. Select the "I/Q OUT" symbol to unfold the "I/Q Analog" block.
2. To (re) route the signal to the analog outputs, select the "I/Q Stream Mapper" block.
3. To enable the baseband signal at the analog outputs, select "Block Diagram > I/Q Analog > I/Q Analog On".
4. To access the dialog box for configuring the analog output signal, select "I/Q Analog > I/Q Analog Settings > General".



The dialog comprises the settings for selecting the analog output signal type (single-ended or differential), enabling and generating an RF envelope signal, and adding digital impairments to the signal.

5. To configure connected external instruments, use the "System Config > System Configuration > External RF and I/Q" dialog.

The parameters defining the voltage level of the output signal are interdependent. Consider the limits listed in "[Maximum overall output voltage](#)" on page 437.

Maximum overall output voltage

The voltage of the analog output signals is defined as a combination of output voltage of the I and Q signal components and an optional bias voltage. If the differential output is used, an additional offset can be set, too. The values of these parameters are interdependent so that the magnitude of the sum of output voltage and bias voltage must not exceed 4V.

The following applies:

- Single ended signal:
 $V_p + V_{bias} \leq 4 \text{ V}$
- Differential signal:
 $0.5 \cdot V_p + |V_{bias}| + 0.5 \cdot V_{offset} \leq 4 \text{ V}$

Where:

- V_p is the output voltage as set with the parameter [I/Q Level Vp EMF](#)
- V_{bias} is the bias voltage as set with the parameter [Bias \(EMF\)](#)
- V_{offset} is the offset between inverting and non-inverting output as set with the parameter [Offset \(EMF\)](#)

For more information, see data sheet.

Related settings

- See [Chapter 8.7.1, "General Analog I/Q Output Settings"](#), on page 437
- See [Chapter 4.2, "Impairing the Signal"](#), on page 243.

See user manual R&S SMBVB-K540, R&S SMBVB-K541 Envelope Tracking and AM/AM, AM/PM Predistortion.

8.7.1 General Analog I/Q Output Settings

Access:

- ▶ Select "I/Q Analog > I/Q Analog Outputs > General".

For description of the impairments settings, see [Chapter 4.2, "Impairing the Signal"](#), on page 243

Settings:

State	438
Set to Default	438
Save/Recall	438

RF Envelope.....	439
Show Connector.....	439
I/Q Output Type.....	439
Mode.....	439
Digital Attenuation.....	440
I/Q Level Vp EMF.....	440
Couple I/Q Bias.....	440
Bias (EMF).....	440
Offset (EMF).....	441

State

Enables/disables the analog I/Q output.

Note: By default, these output connectors are deactivated.

Remote command:

`[:SOURce<hw>] :IQ:OUTPut:ANALog:STATe` on page 825

Set to Default

Calls the default settings. The values of the main parameters are listed in the following table.

Parameter	Value
"State"	Not affected by the "Set to Default"
"RF Envelope"	Off
"I/Q Output Type"	Depends on "System Configuration > External RF and I/Q > Preset behavior: Keep connections to external instruments": <ul style="list-style-type: none"> • "Off": Single Ended • "On": Not affected by the "Set to Default"
"I/Q Level Vp (EMF)"	1 V
"Bias (EMF)"	0 mV

Remote command:

`[:SOURce<hw>] :IQ:OUTPut [:ANALog] :PRESet` on page 826

Save/Recall

Accesses the "Save/Recall" dialog, that is the standard instrument function for saving and recalling the complete dialog-related settings in a file. The provided navigation possibilities in the dialog are self-explanatory.

The filename and the directory, in which the settings are stored, are user-definable; the file extension is however predefined.

See also [Chapter 9, "File and Data Management"](#), on page 442.

Remote command:

`[:SOURce<hw>] :IQ:OUTPut [:ANALog] :SETTing:CATalog?` on page 826

`[:SOURce<hw>] :IQ:OUTPut [:ANALog] :SETTing:STORe` on page 826

`[:SOURce<hw>] :IQ:OUTPut [:ANALog] :SETTing:LOAD` on page 826

`[:SOURce<hw>] :IQ:OUTPut [:ANALog] :SETTing:DELeTe` on page 827

RF Envelope

In instruments equipped with option R&S SMBV100B-K540, enables the output of a control signal that follows the RF envelope. This control signal is provided for power amplifiers envelope tracking testing. The signal is output at the I/I Bar connectors.

The envelope tracking (ET) is a method used by modern power amplifiers (PA) to improve their efficiency, especially when amplifying high crest factor RF signals. With envelope tracking, the PA estimates, i.e. "tracks", the RF signal and varies the supply voltage at the end amplifying stage synchronous to the changes in the RF signal.

See user manual R&S SMBVB-K540, R&S SMBVB-K541 Envelope Tracking and AM/AM, AM/PM Predistortion.

Remote command:

```
[ :SOURce<hw> ] : IQ : OUTPut [ :ANALog ] : ENVeloPe : STATe
```



Show Connector

Accesses a dialog that displays the physical location of the selected connector on the front/rear panel of the instrument.

I/Q Output Type

Selects the type of output signal.

The provided parameters in the "I/Q Analog Outputs" dialog depend on the selected output mode.

- | | |
|----------------|--|
| "Differential" | <p>Option: R&S SMBVB-K17</p> <ul style="list-style-type: none"> • If "RF Envelope > On"
The inverted envelope signal \bar{E} is output at the I Bar connectors. • If "RF Envelope > Off"
The analog I/Q signal components are output at the I/Q Bar connectors. |
| "Single-Ended" | <ul style="list-style-type: none"> • If "RF Envelope > On"
The envelope signal E is output at the I connectors. • If "RF Envelope > Off"
Single-ended output at the I/Q connectors. <p>You can define a bias between the output signal and ground.</p> |

Remote command:

```
[ :SOURce<hw> ] : IQ : OUTPut [ :ANALog ] : TYPE on page 827
```

Mode

Selects the mode for setting the outputs, independent or together.

- | | |
|------------|---|
| "Fixed" | <p>The I/Q signal components settings are predefined fix values:</p> <ul style="list-style-type: none"> • "Bias (EMF)" = "Offset (EMF)" = 0V • "I/Q Level Vp (EMF)" <ul style="list-style-type: none"> – Single ended mode: "I/Q Level Vp (EMF)" = 1 V – Differential mode: "I/Q Level Vp (EMF)" = 2 V |
| "Variable" | <p>Option: R&S SMBVB-K17</p> <p>Enables modification of the I/Q signal components settings.</p> |

"Var. Attenuated"

Enables a precise digital attenuation of the signal.

The level of the signal is attenuated by the value set with the parameter [Digital Attenuation](#).

Remote command:

`[:SOURce<hw>] :IQ:OUTPut [:ANALog] :MODE` on page 827

Digital Attenuation

In "Mode = Var. Attenuated", attenuates the level of the baseband and the RF signal.

Remote command:

`[:SOURce<hw>] :IQ:OUTPut [:ANALog] :POWer:DATTenuation` on page 829

I/Q Level Vp EMF

In "Mode > Variable", sets the output voltage for the I and Q signal components.

The value range is adjusted so that the maximum overall output voltage does not exceed 4V, see ["Maximum overall output voltage"](#) on page 437.

Remote command:

`[:SOURce<hw>] :IQ:OUTPut :LEVel` on page 827

Couple I/Q Bias

In "Variable Mode", couples the bias setting of the I signal and the Q signal component. With activated coupling, the settings of the I signal component automatically apply to the Q signal component.

Remote command:

`[:SOURce<hw>] :IQ:OUTPut [:ANALog] :BIAS:COUPling [:STATe]` on page 828

Bias (EMF)

If a bias is enabled, a DC voltage is superimposed upon the I or Q signal.

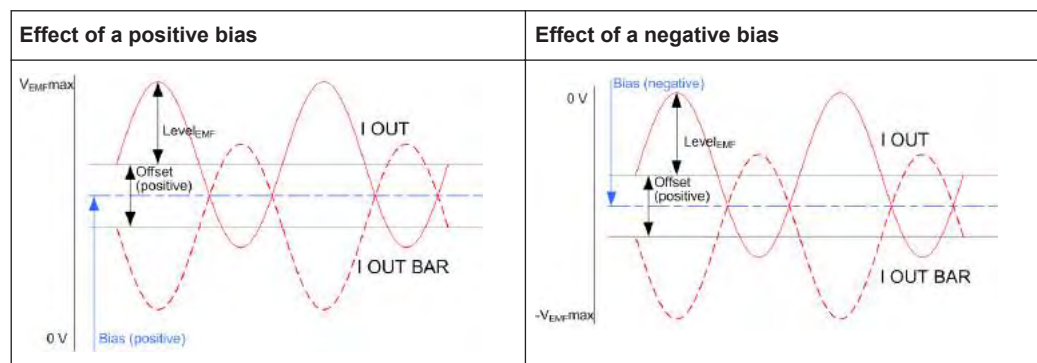

In "Single Ended" mode, this parameter defines the bias between the output signal and ground. It can be used to define the operating point of a DUT.

The value range is adjusted so that the maximum overall output voltage does not exceed 4V, see ["Maximum overall output voltage"](#) on page 437.

Remote command:

`[:SOURce<hw>] :IQ:OUTPut [:ANALog] :BIAS:I` on page 828

`[:SOURce<hw>] :IQ:OUTPut [:ANALog] :BIAS:Q` on page 828

Offset (EMF)

Sets an offset between the inverting and the non-inverting output.

The value range is adjusted so that the maximum overall output voltage does not exceed 4V, see "[Maximum overall output voltage](#)" on page 437.

The selected offset is set half in the positive and half in the negative direction.

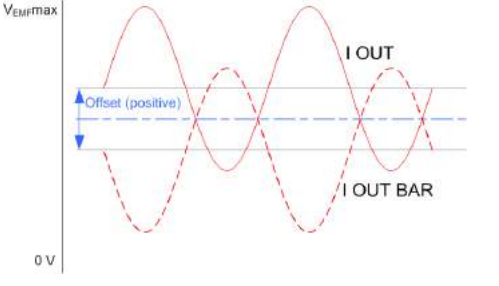
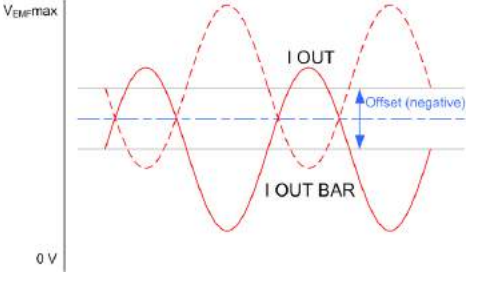
Effect of a positive offset	Effect of a negative offset
	
<p>A positive offset is set with half of the value in positive direction at the non-inverting outputs, in negative direction at the inverting outputs.</p>	<p>A negative offset is set with half of the value in negative direction at the non-inverting outputs, in positive direction at the inverting outputs.</p>

Example: Effect of a positive offset on the I signal component

"I Offset" = 100.0 mV

The offsets applied on the two output connectors as follows:

- +50.0 mV at the positive signal output
- -50.0 mV at the inverted signal output

Remote command:

[:SOURce<hw>] : IQ : OUTPut [:ANALog] : OFFSet : I on page 828

[:SOURce<hw>] : IQ : OUTPut [:ANALog] : OFFSet : Q on page 828

9 File and Data Management

The R&S SMBV100B uses files to save all instrument data. The instrument allows you to store and to load instrument settings, and to import and to export user data for processing in another instrument or later. Finally, you can create a screenshot of the current settings displayed on the screen and save it as a file.

The main save and recall function for managing of the instrument settings is available via the Save/Rcl key. Dedicated save/recall functions are available in the settings dialogs of the digital standards or accessible whenever user files are used.

This section focuses on the functions provided for managing of user data files and covers the topics listed below.

For information on the related remote control commands, refer to [Chapter 12.6, "Memory Subsystem"](#), on page 587.

For information on how to save the displayed setting in a file, refer to [Chapter 9.10, "Creating Screenshots of Current Settings"](#), on page 474.

• About the File System	442
• Restoring the (Default) Instrument Configuration	445
• Protecting Data	451
• Saving and Recalling Instrument Settings	451
• Accessing Files with User Data	457
• Exporting Remote Command Lists	461
• Loading, Importing and Exporting Lists	461
• Using the File Manager	462
• How to Transfer Files from and to the Instrument	468
• Creating Screenshots of Current Settings	474

9.1 About the File System

Depending on the contained information, two file groups can be distinguished: system and user files.



Due to security reasons, system files and the system directory are protected and therefore not accessible.

The scope of this section is only the files with user data.

This section is an overview of the R&S SMBV100B file system and covers the following topics:

- ["Types of user data"](#) on page 443
- ["File storage location"](#) on page 443
- ["File handling"](#) on page 444
- ["File naming conventions"](#) on page 444
- ["File extensions"](#) on page 445

- ["File contents"](#) on page 445

Types of user data

The **user data** includes saved instrument settings, data for the different digital standards, lists for the list mode and the user correction, and the waveforms for the arbitrary waveform generator.

You can also save the settings in the form of command sequences, e.g. in SCPI or other languages.

Depending on the **content**, the **user data** can be roughly divided into the following data types:

- *Settings*, e.g. the current instrument settings, can be saved and loaded later or used in other instrument of the same kind.
See [Chapter 9.4, "Saving and Recalling Instrument Settings"](#), on page 451
- *SCPI scripts*, a series of commands that can be run to perform a task.
See [Chapter 9.6, "Exporting Remote Command Lists"](#), on page 461
- Externally or internally generated *lists*, e.g. user correction lists, or data lists can be loaded in the instrument.
See [Chapter 9.7, "Loading, Importing and Exporting Lists"](#), on page 461 and [Chapter 9.5, "Accessing Files with User Data"](#), on page 457
- Externally or internally generated *complex modulation and control data* can be loaded in the instrument.
See [Chapter 9.5, "Accessing Files with User Data"](#), on page 457
- Externally generated *waveforms* can be loaded in the "Arbitrary Waveform Generation" dialog.
See [Chapter 3.6, "Using the Arbitrary Waveform Generator \(ARB\)"](#), on page 145

Depending on the **data storage method**, user data can be:

- *Persistent*, i.e. user files that are recorded on the data storage.
Data is preserved when instrument is powered off and can be accessed and modified subsequently.
- *Temporary*, i.e. volatile data that the instrument retains while it is powered on.
Volatile data is immediately lost when the R&S SMBV100B is switched off.

File storage location

Without any additional measures, the R&S SMBV100B stores user files on the internal memory, the [removable memory](#), or if connected, on a memory stick.

Both, the user directory `/var/user/` on the internal memory or the `/usb/` directory on the memory stick, can be used to **preserve** user-defined data. Any directory structure can be created.

The `/var/volatile` directory serves as a RAM drive and can be used to protect sensitive information. The data is available **temporarily**.

If option R&S SMBVB-B80 is installed, the R&S SMBV100B maps the user directory to the [removable memory](#). If a memory is mounted, user data is saved there. Otherwise user data is redirected to the volatile memory.

Default storage location

The R&S SMBV100B stores user data in the user directory.

Depending on the installed options, the user directory is physically located on the internal memory or on the [removable memory](#).

In the file system, user directory is always indicated as `/var/user/`.

In manual control, you access this directory via the "File Manager", see [Chapter 9.8, "Using the File Manager"](#), on page 462. In remote control, you can query it with the command `:SYSTEM:MMEMORY:PATH:USER?`.

To query and change the default directory used for mass storage, use the command `:MMEMORY:CDIRECTORY`.

File handling

To *access files* and the file system of the instrument or to use the general file management functions such as copying and moving data, use the standard "File Manager" dialog.

See [Chapter 9.8, "Using the File Manager"](#), on page 462.

To *transfer files* from and to the instruments or to exchange files, use one of the following alternatives:

- Connect a memory stick to one of the USB interfaces.
The instrument recognizes automatically a connected memory stick and assigns the `/usb/` drive to it.
- Connect the instrument to a LAN.
An instrument connected to a LAN supports two standard file transfer methods from a remote client:
 - FTP (file transfer protocol)
 - File sharing according to the SAMBA/SMB (server message block) protocol.Both file transfer methods access the folder `/user`, that is the `/var/user/` folder on the instrument.
For step-by-step description, see [Chapter 9.9, "How to Transfer Files from and to the Instrument"](#), on page 468.
- Map a network folder or a computer to an instrument connected to a LAN.
A mapped network folder is indicated as `/shares/<"Local Folder">`.
For step-by-step description, see [Chapter 9.8.4, "How to Map a Network Folder"](#), on page 466.

File naming conventions

To enable files to be used in different file systems, consider the following file naming conventions:

- The *filename* can be of any length and *is case-sensitive*, i.e it is distinguished between uppercase and lowercase letters.
- All letters and numbers are permitted (numbers are, however, not permitted at the beginning of the filename).

- Avoid using special characters.
- Do not use slashes "\" and "/". These symbols are used in file paths.
- Avoid using the following filenames: CLOCK\$, CON, COM1 to COM4, LPT1 to LPT3, NUL or PRN
They are reserved by the operating system.

File extensions

The R&S SMBV100B distinguishes the files according to their extensions; each type of file is assigned a specific file content and also a specific file extension. The extension is usually of no consequence to you since access to the files occurs in the individual dialogs where only the relevant type of file is available. For example, files with user correction data can only be saved and loaded in the "UCOR" dialog.

See [Chapter A.3, "Extensions for User Files"](#), on page 972 for an overview of the supported file extensions.

File contents

To maintain the file size and to accelerate the loading and processing times, not all instrument settings but rather the settings in state different than the preset one are stored. Considered is also configuration data for the operating elements and lists with user data, e.g. dialog positions and a list of user correction data. However, if a list data is part of the instrument settings, a reference to this list is stored, not the list itself.

This approach ensures that the created files contain only relevant information and allows you to transfer instrument settings even between different equipped signal generators. During the recall process, the instrument interprets only the relevant settings; all non-referenced parameters are set to their preset values. Error messages indicate the settings which cannot be implemented, like referencing non-existing lists or the attempt to activate settings which are not supported by the instrument.



Network settings and remote settings cannot be saved and restored.

9.2 Restoring the (Default) Instrument Configuration

The R&S SMBV100B has various options to set default settings, see [Figure 9-1](#). You can preset the R&S SMBV100B to an initial state at any time as a known starting point for configurations. It is often useful as a first step in troubleshooting when unusual results arise.

The graph on [Figure 9-1](#) shows the impact of the particular reset functions.

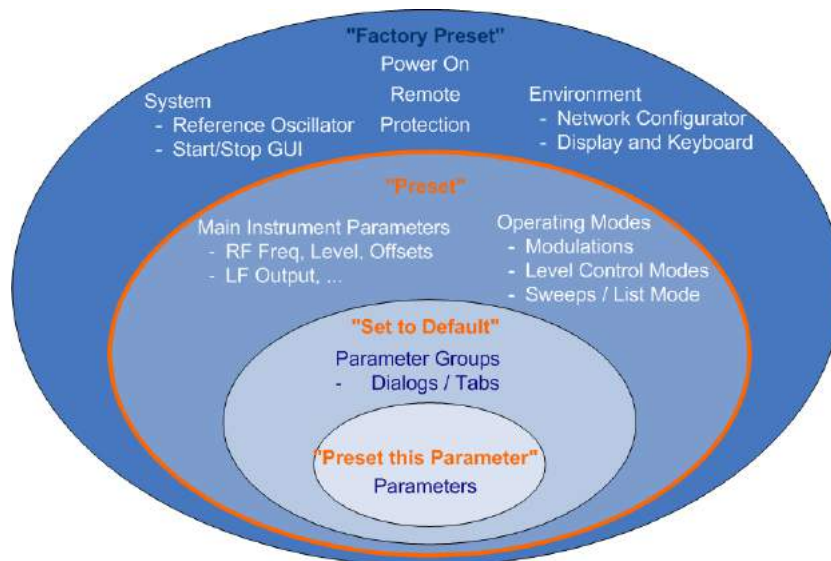

Figure 9-1: Parameter and operating modes, reset by the respective preset functions

Overview of the characteristics of the preset functions

Select the preset option that most fits to your particular application:



- [Preset]
It is the most frequently used function.
A **Preset** executes a defined instrument setup to provide an initial instrument state as a basis for a new configuration. It resets all parameters and switching states, including also the states of inactive operating modes.
Network, remote access or system settings are retained.
- ▶ To execute a preset, press the [Preset] key at the front panel.

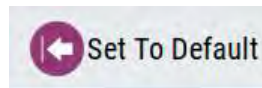

- "Set to Default"
Set To Default relates to individual dialogs or tabs and resets the associated settings of the corresponding dialog. All other settings are retained.
For example, you can use it to reset all digital modulation settings in the "Custom Digital Mod" dialog.
- ▶ To reset the grouped settings, click "Set To Default".



- "Preset this parameter"
Sets a single parameter to its default value.

- ▶ To reset an individual parameter: Open its context-sensitive menu and select "Preset this parameter...".

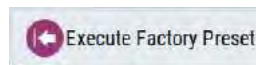

- "Factory Preset"
A factory preset is the most profound preset function that resets almost all instrument settings, including reference oscillator, network and remote access settings. Retained are the following settings:
 - Security, password, and settings protected by these passwords
 - User-defined data, like setups or data lists
 - Settings that relate to an integration of the instrument in a measurement setup.

- ▶ To restore the factory defaults, select [System Config > Setup > Settings > Factory Preset](#).

Note: Perform a "Factory Preset" only if it is necessary. After a "Factory Preset", the network connection to the instrument no longer exists.

Presetting the instrument to a user-defined instrument state

The reset functions set the parameters and operating modes to default values predefined by the factory. Alternatively to these default settings, you can:

- Define user-specific recall settings to be restored after a preset (see [Chapter 9.2.3, "How to Recall User Settings Automatically after Preset"](#), on page 449)
- Store and reload user-defined instrument states (see [Chapter 9.4.2, "How to Save and Recall Instrument Settings"](#), on page 456)

Mark / Do not mark parameters changed from preset

To survey the current state of the settings concerning default values, the R&S SMBV100B offers a feature that visually identifies deviations from the default values.

For more information, see [Chapter 9.2.2, "How to Identify Parameters Which Are Not in a Preset State"](#), on page 448.

9.2.1 Preset, Set to Default and Factory Preset Settings

Preset	447
Set To Default	448
Preset this Parameter	448
Execute Factory Preset	448

Preset

Resets all parameters and switching states, and closes all opened dialogs.

Note: External instruments connected to the R&S SMBV100B are also preset.

See [Chapter 8.5.2, "External RF and I/Q Settings"](#), on page 414.

Consider also the following possibilities:

- You can define the settings that are restored when you preset the instrument (see [Chapter 9.2.3, "How to Recall User Settings Automatically after Preset"](#), on page 449)
- You can reset the instrument to the factory state (see ["Execute Factory Preset"](#) on page 448)

See also [Table 9-1](#) that contains the key parameters that are reset by the corresponding preset functions.

Remote command:

*RST on page 583

Set To Default

Resets the associated settings of the corresponding dialog or tab.

Remote command:

For example, [:SOURce<hw>]:BB:<Digital Standard>:PRESet

Preset this Parameter

Restores the default value of a single parameter.

Execute Factory Preset

Resets the instrument to its factory settings.

Note: "Factory Preset" retains all security settings and does not delete any user files like setups or user data.

See also [Table 9-1](#) that contains the key parameters that are reset by the corresponding preset functions.

Remote command:

:SYSTem:FPReset on page 586

9.2.2 How to Identify Parameters Which Are Not in a Preset State

To recognize the current state of the settings related to their default values at the first glance, enable a function that visually identifies parameters in states different than preset.

To activate this display:

1. Open the context-sensitive menu (touch and hold the screen anywhere in the GUI of the R&S SMBV100B).
2. Select "Mark all parameters changed from preset".



If enabled, the corresponding settings are marked.

Example:

Frequency	4.000 000 000 000 GHz	
Offset	10.000 000 kHz	Multiplier 1.000
User Variation		
Variation Active	<input checked="" type="checkbox"/>	Variation Step 1.000 000 000 MHz

Figure 9-2: Labeled parameters show that the value deviates from its default

Frequency = changed (default = 1 GHz)
 Offset = changed (default = 0 kHz)
 Multiplier = unchanged
 Variation active = changed (default = disabled)
 Variation step = unchanged

9.2.3 How to Recall User Settings Automatically after Preset

You can define the settings that are restored when you preset the instrument.

1. Configure the settings as required. Save them as described in [Chapter 9.4.2, "How to Save and Recall Instrument Settings"](#), on page 456.
2. Save the settings as a file with the predefined filename `UserPreset.savrc1.txt`. Save this file in the directory `/var/user/`.

The filename `UserPreset.savrc1.txt` and the directory `/var/user/` are mandatory.

Now when you press the [Preset] key or send the `*RST` command to the instrument, the defined settings are restored.

An "Info" message appears and confirms, that a file with user-defined preset setting is loaded.

9.2.4 Reference

See [Table 9-1](#) for an overview of the main generator settings that are affected by the corresponding preset functions. While the regular [Preset] key primarily resets the signal relevant parameters of the instrument, the "Factory Preset" affects almost all instrument settings.

For information on the default values of further parameters, refer to the description of the corresponding remote commands.

Table 9-1: Key parameters affected by preset and factory preset

Parameter	Preset value	Preset	Factory Preset
RF frequency	1 GHz	x	x
RF level (RF output)	off	x	x
RF OFF mode	-	-	x
Offsets	0	x	x
Modulation state	off	x	x
Uninterrupted level settings	off	x	x
Level attenuator mode	auto	x	x
Level ALC (internal level control)	auto	x	x
Level UCOR (user correction)	off	x	x
LF output state	off	x	x
Sweep state	off	x	x
List mode state	off	x	x
Reference frequency settings (reference oscillator)	-	-	x
Power on settings (Level/EMF)	-	-	x
Network settings	-	-	x
Hostname	-	-	x
GPIB address	-	-	x
Start/Stop display update	-	-	x
Display and keyboard settings	-	-	x
Preset behavior: Keep connections to external instruments	off	-	x
Password and settings protected by passwords (e.g. disabled LAN or USB)	-	-	-
Security settings	-	-	-
User files (setups ²⁾ , data lists, etc.)	-	-	-

- ²⁾ `UserPreset.savrcltxt` is renamed as `UserPresetInactive.savrcltxt`; an existing file with the same name is overwritten.



If the default values in the "Remote Access" dialog had been changed, a factory preset via remote control (`:SYSTem:FPReset`) terminates the connection to the instrument. Security settings are never reset.

Resets all parameters and switching states, and closes all opened dialogs.



A [Preset] resets also external instruments connected to the R&S SMBV100B. See [Chapter 8.5.2, "External RF and I/Q Settings"](#), on page 414.

9.3 Protecting Data

During operation, the R&S SMBV100B saves user data permanently in the user directory, see ["File storage location"](#) on page 443.

To protect any classified data and to avoid saving any sensitive data on the R&S SMBV100B permanently, you can:

- Install the option **removable memory** R&S SMBVB-B80
This option ensures that user data is never saved on the internal memory.
 - Per default, if removable memory is **mounted**, user data is **saved permanently and only on this storage medium**.
You can access data saved on the removable memory just as data stored in the `/var/user/`.
 - If volatile mode is activated or there is **no memory mounted or it is removed** during operation, user data is stored **temporarily in the volatile memory** of the instrument.
This data is lost once the instrument is switched off.
- Store user files **temporarily in the /var/volatile directory**, which remains available only until the instrument is switched off.
You can access data saved in volatile memory just as data stored permanently in the `/var/user/`.
See also [Chapter 9.8.3, "How to Display All Saved Files"](#), on page 466.
- Activate the **volatile mode** so that no user data can be written to the internal memory permanently.
The removable memory is protected, too.
Instead, you can only save user data:
 - Temporary in the volatile memory
 - On a connected external storage device, such as a memory stickSee also:
 - ["Default storage location"](#) on page 444
 - ["Volatile Mode"](#) on page 510
 - [Chapter 9.9.4, "Using a USB Storage Device for File Transfer"](#), on page 473

9.4 Saving and Recalling Instrument Settings

Possibly you would like to restore or repeat a signal generation you performed under specific conditions on the instrument. Or, in a test setup with more than one signal generator, you want to transfer the used settings to another R&S SMBV100B. Some test

setups also require similar settings in all instrument paths. In these cases, you can save and recall instrument and user settings, and possibly other related data.

In each of these cases, you can create a file with the complete instrument settings or you can choose to save only the settings belonging to a particular digital standard. The instrument uses a similar save/recall principle; both ways are scope of this section.

Save/Recall the complete instrument settings

Two different methods are available for managing *complete instrument settings*:

- Immediate (quick) Save/Recall
A defined set of instrument settings are saved or recalled quickly in just one step, without defining a filename or storage location. This function enables a fast switching between different instrument settings.
- Save/Recall in files with user-defined names
The defined set of instrument settings are stored to a definable storage location. The file extension is *.savrc1.txt.
Settings files created in this way are visible in the file system and accessible with the supported methods for file handling.

In the general case, a recall process replaces the instruments settings with the saved values. An exception is the frequency and level settings. During recall of the instrument settings, it is possible to retain the current settings or to overwrite them with the stored values.

Save/Recall the settings belonging to a firmware option

Each of the firmware option provides a special "Save/Recall" function to manage directly the settings associated to the corresponding digital standard, e.g. all settings in the "3GPP FDD" dialog.

The "Save/Recall" function creates files with user-defined names, predefined file extension and on a definable storage location. The files are accessible with the supported methods for file handling.



Accessing and recalling instrument setups

For quick access to a stored instrument setup file, assign the appropriate action to the [★ (User)] key.

See [Chapter 10.3.3, "Assigning Actions to the \[★ \(User\)\] Key"](#), on page 500.

9.4.1 Save/Recall Settings

To access the dialog for storing and loading the complete instrument settings

1. Press the [Save/Rcl] key.
2. Select "Operation Mode > Save or Recall" to access the corresponding settings.

The provided settings for both operations are similar and closely related.

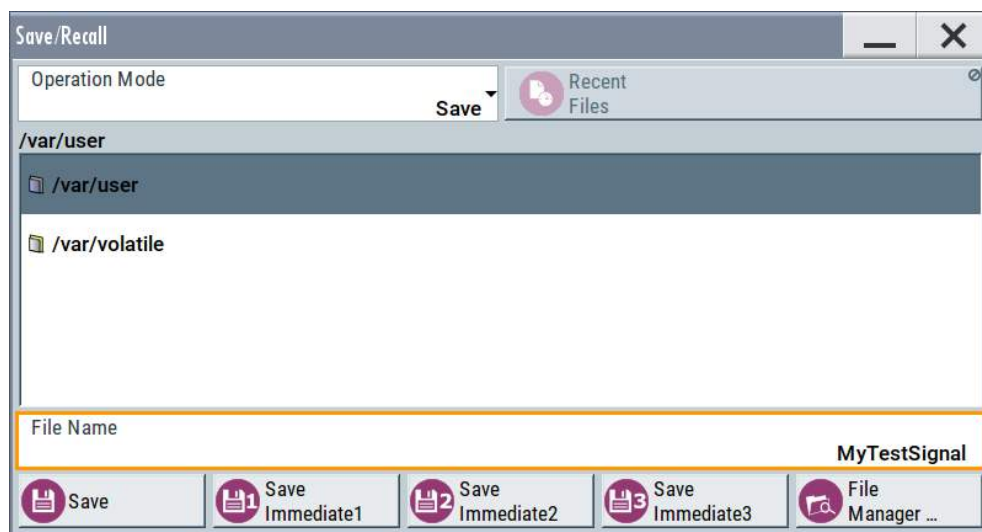

To access the dialog for storing and loading the settings of a firmware option

- ▶ In the general dialog of the corresponding digital standard, select the "Save" or "Recall" function.
For example, select "Block Diagram > Baseband > EUTRA/LTE > General > Save".

The name of the dialog is context-sensitive and differs depending on the particular digital standard. The provided functions are similar.

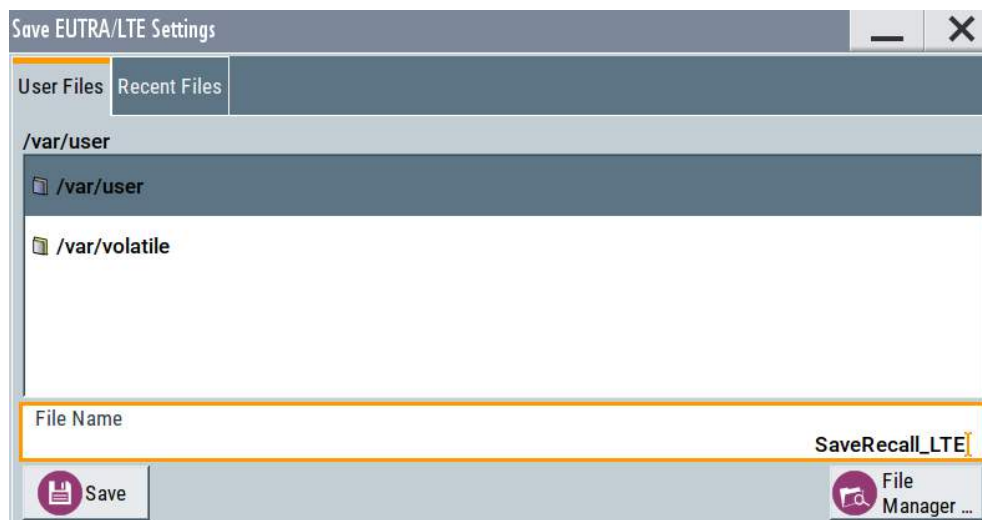

Settings:

Operation Mode.....	454
Directory, File List and Filename.....	454
Recent files.....	454
Show SCPI List.....	454
SCPI List.....	455
Save.....	455
Save Immediate x.....	455

Exclude Frequency.....	455
Exclude Level.....	455
Recall.....	455
Recall Immediate x.....	455
File Manager.....	456

Operation Mode

Accesses the settings for storing ("Save") and loading ("Recall") of the instrument settings, or for exporting created SCPI files ("SCPI-Export").

See [Chapter 9.6, "Exporting Remote Command Lists"](#), on page 461.

Directory, File List and Filename

Note:

You access this generic standard function each time you perform one of the following:

- Save or load (settings) files
- Define a folder in that these files are saved
- Navigate through the file system.

The dialog name changes depending on the context. The provided functions are self-explanatory and similar.

Use the settings for example as follows:

- To navigate through the file system, use the directory tree.
- To create a file, load and save files, use the dedicated functions ["New"](#), ["Select"](#), ["Save"](#), and ["Recent files"](#).
- To access the general data list editor, use the ["Edit"](#) button (see also [Chapter 6.10.7, "List Editor"](#), on page 314).
- To perform standard file management functions, like create directories, move, copy, delete files and/or directories, use the standard "File Manager" function (see [Chapter 9.8, "Using the File Manager"](#), on page 462).

Remote command:

To list all files in a directory:

`:MMEMoRY:CDIRectory` on page 593

`:MMEMoRY:CATalog?` on page 592

Refer to the description of firmware options for the syntax of the corresponding SCPI command:

`[:SOURce<hw>] :BB :<Digital Standard> :SETTing :CATalog`

`[:SOURce] :CORRection :CSET :CATalog?` on page 807

To list files with user data:

`[:SOURce<hw>] :BB :DM :DLISt :CATalog?` on page 701

`[:SOURce<hw>] :BB :DM :CLISt :CATalog?` on page 701

Recent files

Displays the files last used.

Show SCPI List

Opens the "SCPI List", which lists the current settings of the R&S SMBV100B as SCPI commands.

The R&S SMBV100B provides this function for [Operation Mode > SCPI-Export](#).

SCPI List

Contains a list of all SCPI commands corresponding to the current instrument settings.

See also "How to create a SCPI list with the current instrument settings in one step" on page 566

Save

Saves the current instrument settings or the settings belonging to a digital standard under the defined filename.

Remote command:

[:MMEMory:STORe:STATe](#) on page 598

Refer to the descriptions of the firmware options for the correct syntax of the corresponding SCPI commands:

[\[:SOURce<hw>\]:BB:<Digital Standard>:SETTing:STORe](#)

[\[:SOURce<hw>\]:BB:<Digital Standard>:SETTing:DELeTe](#)

Save Immediate x

Stores the current instrument setting in one of the intermediate memories.

These instrument settings are retained until a different instrument setting is stored in the intermediate memory. When the instrument is switched off, the contents of the intermediate memories are retained.

Remote command:

[*SAV](#) on page 584

Exclude Frequency

The current frequency is retained when a stored instrument setting is loaded.

Remote command:

[\[:SOURce<hw>\]:FREQuency\[:CW|FIXed\]:RCL](#) on page 817

Exclude Level

The current level is retained when a stored instrument setting is loaded.

Remote command:

[\[:SOURce<hw>\]:POWer\[:LEVel\]\[:IMMediate\]:RCL](#) on page 868

Recall

Restores the selected configuration.

During recall, the instrument considers all related settings, for example sweeps in active state or lists. An error message indicates the settings which cannot be implemented.

Remote command:

[:MMEMory:LOAD:STATe](#) on page 597

Refer to the descriptions of the firmware options for the correct syntax of the corresponding SCPI command:

[\[:SOURce<hw>\]:BB:<Digital Standard>:SETTing:LOAD](#)

Recall Immediate x

Loads the selected configuration from one of the intermediate memories. A message appears if no instrument configuration is stored in this memory.

Remote command:
[*RCL](#) on page 583

File Manager

Accesses the "File Manager" dialog, see [Chapter 9.8, "Using the File Manager"](#), on page 462.

9.4.2 How to Save and Recall Instrument Settings

Instrument settings can be saved to a file and loaded again later, so that you can repeat the tests with the same settings.



Accessing and recalling instrument setups

For quick access to a stored instrument setup, assign the appropriate action to the [[★ \(User\)](#)] key.

See [Chapter 10.3.3, "Assigning Actions to the \[\[★ \\(User\\)\]\(#\)\] Key"](#), on page 500.

To save and recall instrument settings quickly

1. Select Save/Rcl > "Operation Mode > Save".
2. Select "Save Immediate 1".
The instrument saves its settings in the intermediate memory 1. The filename and the storage location cannot be changed.
3. Adapt the instrument settings as required. Select "Save Immediate 2"
4. To restore the settings, select the "Operation Mode > Recall"
5. Select "Recall Immediate 1"
The instrument is restored to the previous state.
6. Select "Recall Immediate 2" to switch to the settings stored in the second file.

To save complete instrument settings

1. Select Save/Rcl > "Operation Mode > Save".
2. In the file selection dialog, select a filename and storage location for the settings file.
3. Select "Save".
A file with the defined name and path and the extension `*.savrc1.txt` is created.

To restore instrument's configuration

Save the configuration as described in ["To save complete instrument settings"](#) on page 456.

1. To restore settings, select Save/Rcl > "Operation Mode > Recall".

2. To retain the current frequency and level settings, enable "Save/Recall > Exclude Frequency/Level"
3. In the file selection dialog, select the filename and storage location of the settings file.

The settings are restored, but the frequency and level settings are retained; you can repeat the signal generation with the same settings.

See also [Chapter 9.2.3, "How to Recall User Settings Automatically after Preset"](#), on page 449.

9.4.3 How to Recall the Settings of a Firmware Option

Some test setups, e.g. for MIMO tests, require that two or more instruments generate baseband signal with similar settings. One easy way to speed up the configuration is to use the dedicated save/recall function to transfer the configuration data from one instrument to the other.

To use the "Save/Recall" function to transfer settings related to a digital standard to another instrument

1. In the first instrument, select "Baseband > Digital Standard, e.g. 3GPP FDD". Adjust the settings as required.
2. In the "3GPP FDD > General" tab, select "Save".
In the file selection dialog, select a filename and storage location for the settings file.
A file with the defined name and path and a predefined extension (*.3g) is created.
3. Connect both instrument to a LAN.
Alternatively, use a USB flash drive to transfer the created *.3g file to the second instrument.
4. In the second instrument, select "Baseband > 3GPP FDD > General > Recall" to load the stored file.
5. Navigate in the file selection dialog. Select the filename and storage location of the settings file.

The settings are loaded in the second instrument. If the corresponding settings are left unchanged, the second instrument generates a signal with identical baseband settings.

9.5 Accessing Files with User Data

By the calculation of signals according to the different digital standards or by the generation of custom digitally modulated signals, the R&S SMBV100B uses the data from different data sources (see also [Chapter 3.4.1.1, "Data, Clock and Control Signals and](#)

"Sources in the Baseband", on page 89). To simulate the signal of one UE for instance, the instrument modulates and codes the provided data for each channel. It further processes the signal as described in the corresponding standard.

Whenever a data list file is enabled as a data source, the instrument provides direct access to the standard "File Select" function. This function enables you to select, create and edit the data list files.

9.5.1 File Select Settings

The "File Select" dialog opens automatically each time you select a data list file as data source or you select a control list.

To access a loadable data list file

1. Select the "Data List Name" in the individual dialog.
For "Baseband > 3GPP FDD > Base Stations > BS1 > Channel Table > P-CCPCH > Data = Data List", for example, select "DList Patt = None".

A "File Select" dialog for loading, creating and modifying a file is displayed.

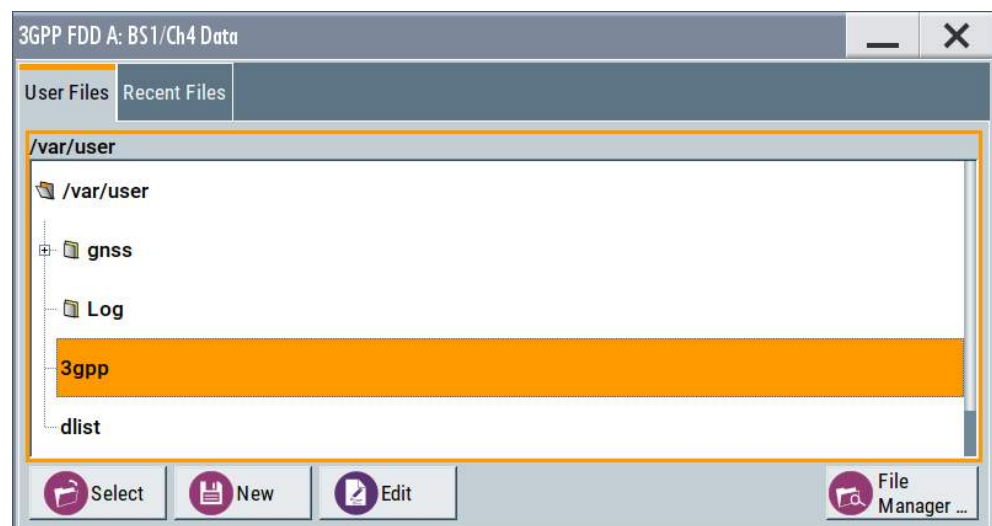

Tip: The name of the dialog is context-sensitive and differs depending on the particular function this dialog is from. However, the provided functions are similar.

2. To load an existing file:
Navigate through the file system.
Select the file and confirm with "Select".
3. To create a file, for example if there is no data list file specified:
Navigate through the file system.
Select "New" and specify the filename.
A new empty file is created and saved in the selected folder.
4. To edit an existing or newly created file:
Navigate through the file system.

Select the file and select "Edit".

The standard "Data List Editor" dialog opens

See [Chapter 3.5.3.7, "Data List Editor"](#), on page 128.

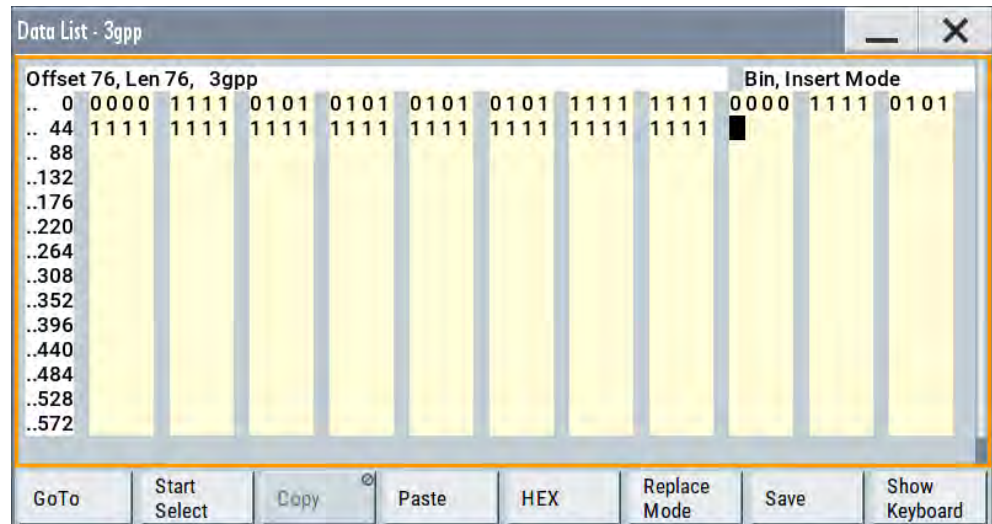

5. Edit the file content.
Confirm with "Save".

Settings:

Directory, File List and Filename	459
Functions for handling of data lists	460
Functions for handling of control lists	460
Recent files	460
File Manager	460

Directory, File List and Filename

Note:

You access this generic standard function each time you perform one of the following:

- Save or load (settings) files
- Define a folder in that these files are saved
- Navigate through the file system.

The dialog name changes depending on the context. The provided functions are self-explanatory and similar.

Use the settings for example as follows:

- To navigate through the file system, use the directory tree.
- To create a file, load and save files, use the dedicated functions "New", "Select", "Save", and [Recent files](#).
- To access the general data list editor, use the "Edit" button (see also [Chapter 6.10.7, "List Editor"](#), on page 314).
- To perform standard file management functions, like create directories, move, copy, delete files and/or directories, use the standard "File Manager" function (see [Chapter 9.8, "Using the File Manager"](#), on page 462).

Remote command:

To list all files in a directory:

[:MMEMory:CDIRectory](#) on page 593

[:MMEMory:CATalog?](#) on page 592

Refer to the description of firmware options for the syntax of the corresponding SCPI command:

[\[:SOURce<hw>\]:BB:<Digital Standard>:SETTing:CATalog](#)

[\[:SOURce\]:CORRection:CSET:CATalog?](#) on page 807

To list files with user data:

[\[:SOURce<hw>\]:BB:DM:DLISt:CATalog?](#) on page 701

[\[:SOURce<hw>\]:BB:DM:CLISt:CATalog?](#) on page 701

Functions for handling of data lists

Provided are the following standard functions for file handling:

"Select" Select and load the file.

Remote command:

[\[:SOURce<hw>\]:BB:DM:DLISt:SElect](#) on page 702

Refer to the descriptions of the firmware options for the correct syntax of the corresponding SCPI command:

[\[:SOURce<hw>\]:BB:<Digital Standard>:...:DATA DLISt](#)

[\[:SOURce<hw>\]:BB:<Digital Standard>:...:DSElect](#)

"New" Creates file with the specified "Filename".
To confirm, select "OK"; use "Cancel" to undo the operation.
To edit the file content, select "File Select > Edit".

"Edit" Accesses the "Data List Editor" and loads the selected file for editing
See [Chapter 3.5.3.7, "Data List Editor"](#), on page 128.

Functions for handling of control lists

Provided are the following standard functions for file handling:

"Select" Select and load the file.

Remote command:

[\[:SOURce<hw>\]:BB:DM:CLISt:SElect](#) on page 702

"New" Creates file with the specified name. To edit the file content, select
"File Select > Edit".

"Edit" Access the "Control List Editor" and loads the selected file for editing,
see [Control and Marker Lists Editor](#).

Recent files

Displays the files last used.

File Manager

Accesses the "File Manager" dialog, see [Chapter 9.8, "Using the File Manager"](#), on page 462.

9.5.2 How to Create and Access Data and Control Lists

The general principle for accessing files with user data is described in "[To access a loadable data list file](#)" on page 458. Detailed and further information on how to create and access files with user data like data lists and control lists is provided in the following sections:

- [Chapter 3.5.4.2, "How to Create and Assign a Data List"](#), on page 136
Overview of the possible ways and detailed description on how to create data lists.
- [Chapter 3.5.4.1, "How to Create and Assign a Control List"](#), on page 134
Overview of the possible ways and detailed description on how to create control lists.
- [Chapter 12.6.2, "Accessing Files in the Default or in a Specified Directory"](#), on page 588
Information on accessing files in a remote environment

9.6 Exporting Remote Command Lists

To set specific instrument settings or perform tasks automatically, you can create scripts that contain the settings in the form of remote control command sequences.

The R&S SMBV100B also offers an SCPI macro recorder with code generator that is used to record manual settings and create an executable script, see [Chapter 11.14, "How to Record / Create SCPI Lists"](#), on page 565.

Completed scripts are stored in files and possibly converted to different formats, depending on the used language of the source code.

The R&S SMBV100B supports the following commonly used languages:

- Plain SCPI: *.txt
- MATLAB: *.m
- NICVI: *.c

It is also possible to convert the SCPI command list to a user-specific language, see [Chapter 11.15, "How to Convert and Save SCPI Lists"](#), on page 568.

9.7 Loading, Importing and Exporting Lists

The R&S SMBV100B provides built-in editors for creating list files, for example for the list mode or lists with user correction data. You can also create or evaluate them with an external application. The instrument provides interfaces with the following functionality:

- Import and export list files in a standard ASCII format file
- Load files with modulation and control information
- Load of internally or externally generated waveform file

Lists are saved and loaded in the corresponding dialogs. For example, the user correction data list is created and stored in the "User Correction" dialog.

Waveform files are created with the signal generation software R&S WinIQSIM2 or in the dialogs of some of the digital standards.

For more information, refer to:

- [Chapter 9.5.2, "How to Create and Access Data and Control Lists"](#), on page 461
- [Chapter 6.12.3.4, "Import/Export List Files"](#), on page 361

9.8 Using the File Manager

The "File Manager" is a tool similar to a standard Windows Explorer. It helps you manage mass storage media and files stored on the R&S SMBV100B.

You can perform the following tasks:

- Copying multiple files from disk to other media
See [Chapter 9.9, "How to Transfer Files from and to the Instrument"](#), on page 468
- Copying files into another directory
See [Cut, Copy&Paste and Delete](#)
- Renaming and deleting files
- Creating directories
See [Create New Directory](#)
- Mapping shared network folders
See [Chapter 9.8.4, "How to Map a Network Folder"](#), on page 466
- Displaying saved files
See [Chapter 9.8.3, "How to Display All Saved Files"](#), on page 466

Access:

- ▶ Select Save/Rcl > "File Manager".

Tip: Each "Save/Recall" dialog and each "File Select" dialog provides a quick access to the "File Manager", i.e. whenever you select data lists or files with user data.

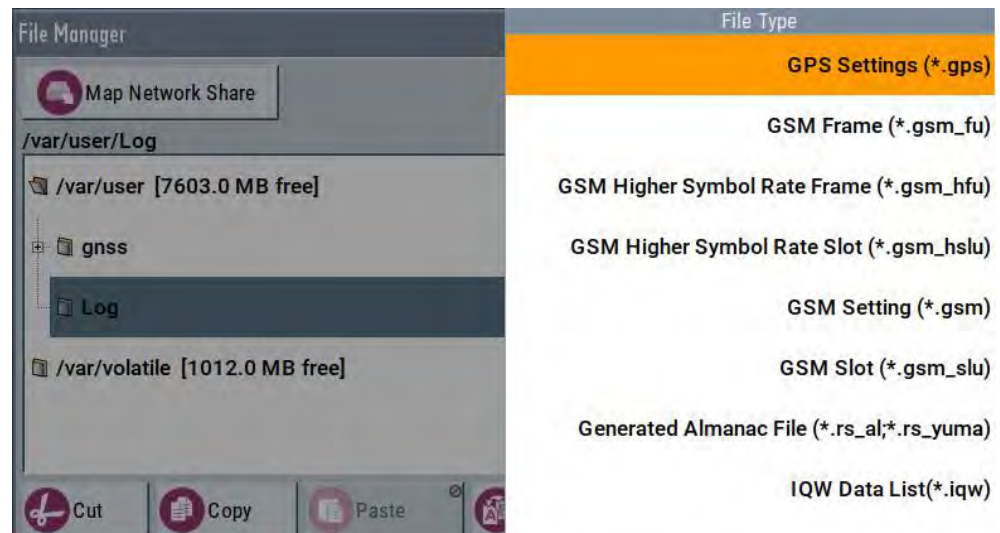

The "File Manager" dialog provides all standard functions required for file management. It displays the contents of the selected folder on the R&S SMBV100B and provides functions to rename, delete, copy, or move individual files.

9.8.1 File Manager Settings

Access:

- ▶ Select Save/Rcl > "File Manager".

Settings:

Map Network Share.....	463
File Type.....	463
Directory and Filename.....	464
Cut, Copy&Paste and Delete.....	464
Rename	464
Create New Directory.....	464

Map Network Share

Accesses the [Map Network Share Settings](#) dialog where you can map one or more network folders.

See also [Chapter 9.8.4, "How to Map a Network Folder"](#), on page 466.

File Type

Selects the file type to be listed. If a file type with a specific file extension is selected, only files with this extension are listed.

See [Chapter A.3, "Extensions for User Files"](#), on page 972 for an overview of the supported file extensions.

Directory and Filename

Selects the directory in which the file to be deleted or copied is located. The dialog lists all files in this directory. Selected files are highlighted. The path is indicated above the directory tree.

Unlike the "Save/Recall" and "File Select" dialogs, the "File Manager" displays the full filenames including extensions.

Remote command:

[:MMEMory:CDIRectory](#) on page 593

Cut, Copy&Paste and Delete

Standard file management functions.

Before a file is deleted, you have to confirm the delete operation.

Remote command:

[:MMEMory:DELeTe](#) on page 597

[:MMEMory:COpy](#) on page 593

Rename

Renames the selected file or directory.

Remote command:

[:MMEMory:MOVE](#) on page 597

Create New Directory

Creates a folder and opens an edit dialog box to enter name and path (absolute or relative to the current directory) of the new folder.

Remote command:

[:MMEMory:MDIRectory](#) on page 597

9.8.2 Map Network Share Settings

Access:

- ▶ Select Save/Rcl > "File Manager > Map Network Share".

The "Map Network Share" dialog provides settings that are similar to the standard Windows Explorer function "Map network drive". These settings help you to create up to 10 "shortcuts" to shared folders or computers in the network.

The dialog displays a list of current mapped network folders. The directory tree of the "File Manager", "Save/Recall", and "File Select" dialogs indicate a mapped network folder as `/shares/<"Local Folder">`.

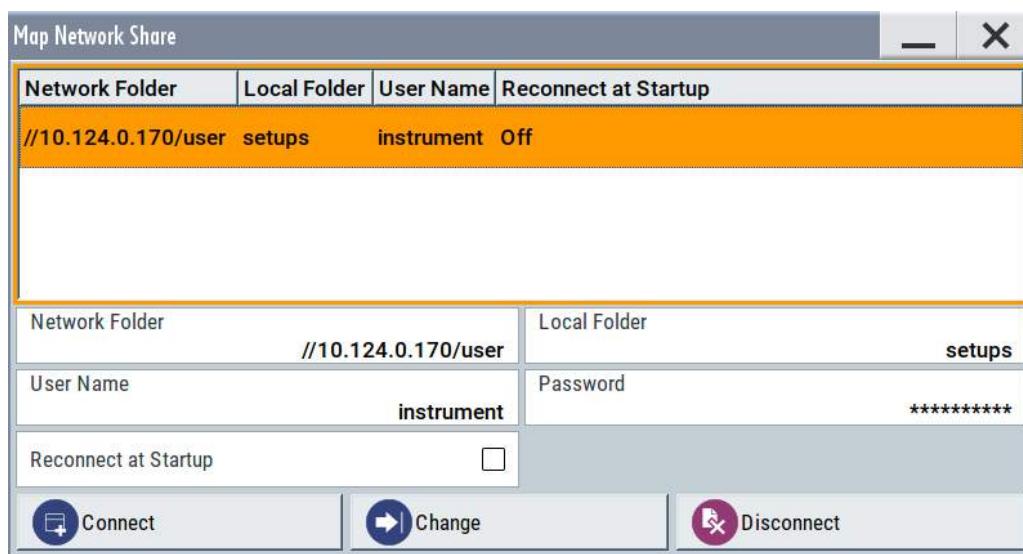

See also [Chapter 9.8.4, "How to Map a Network Folder"](#), on page 466.

Settings:

[Network Folder](#).....465
[Local Folder](#)..... 465
[User Name](#).....465
[Password](#)..... 465
[Reconnect at Startup](#)..... 465
[Connect](#).....466
[Change](#).....466
[Disconnect](#)..... 466

Network Folder

Enter the path of the folder or computer, e.g. `//<IP Address>/user` or `//<server name>/user`.

Local Folder

Enter a letter or an alias name to describe the folder.

In the directory tree, a mapped network folder is indicated as `/shares/ <"Local Folder">`.

User Name

Enter a user name of a user that has the permission to access the selected network folder.

Password

Enter the password of the selected user.

Reconnect at Startup

Enables reconnecting every time you start up the instrument.

Connect

Triggers the instrument to prove the credential and to map (i.e. connect) the selected network folder or computer to the instrument.

You can map up to 10 network folders.

Change

Applies the changes.

Disconnect

Disconnects the network drive.

9.8.3 How to Display All Saved Files

To display all files on the internal memory

1. Select Save/Rcl > "File Manager".
2. Navigate to `/var/user/`.

To display all files on a connected USB flash drive

1. Select Save/Rcl > "File Manager".
2. Navigate to `/usb/`.

To display all files in the volatile memory

1. Select Save/Rcl > "File Manager".
2. Navigate to `/var/volatile/`.

9.8.4 How to Map a Network Folder

Possibly you would like to transfer instrument or user settings to another R&S SMBV100B, distribute waveform files to several instruments or you have to access frequently the same network drive. In these cases, on a R&S SMBV100B connected to a LAN you can create a shortcut to this network folder or this computer.

For information on how to set up a LAN connection, refer to:

- [Chapter 2.1.4, "Setting Up a Network \(LAN\) Connection"](#), on page 37
- [Chapter 11, "Network Operation and Remote Control"](#), on page 520

To map a network folder, proceed as follows:

1. On the computer or the network folder you want to map, enable remote access. You can specify a list of users allowed for remote access. The remote access settings depend on the operating system the remote computer is using. For step-by-step instructions, refer to the documentation of the particular operating system.

2. On the R&S SMBV100B, [enable file transfer via SMB \(samba\)](#).
3. Select "System Config > Setup > Remote Access > Network".
Select:
 - a) "Address Mode > Auto (DHCP)"
 - b) Check that the "DNS Suffix" and "DNS Server" are correct.
4. Press the [Save/Rcl] key.
5. In the "Save/Recall" dialog, select "File Manager > Map Network Share".
6. In the "Map Network Share" dialog, select:
 - a) In the "Network Folder" field, enter `//<IP Address>/user` or `//<Server Name>/user`.
For example, `//10.124.0.170/user`.
 - b) In the "Local Folder" field, enter an alias name, e.g. `setups`.
 - c) Enter the "User Name" and "Password" of a user with a remote access permission to the selected network folder.
 - d) If necessary, enable "Reconnect at Startup".
 - e) Select "Connect".

The selected network folder is mapped to your instrument. The list of mapped network folders is updated.

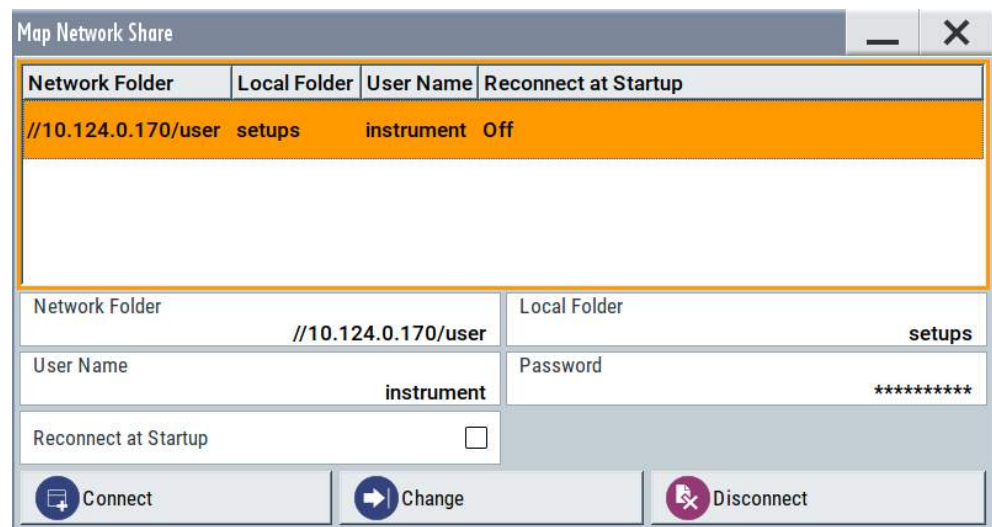

7. Close the "Map Network Share" dialog.

The navigation tree in the "File Manager" dialog displays the mapped network folder as `/shares/Setups`.

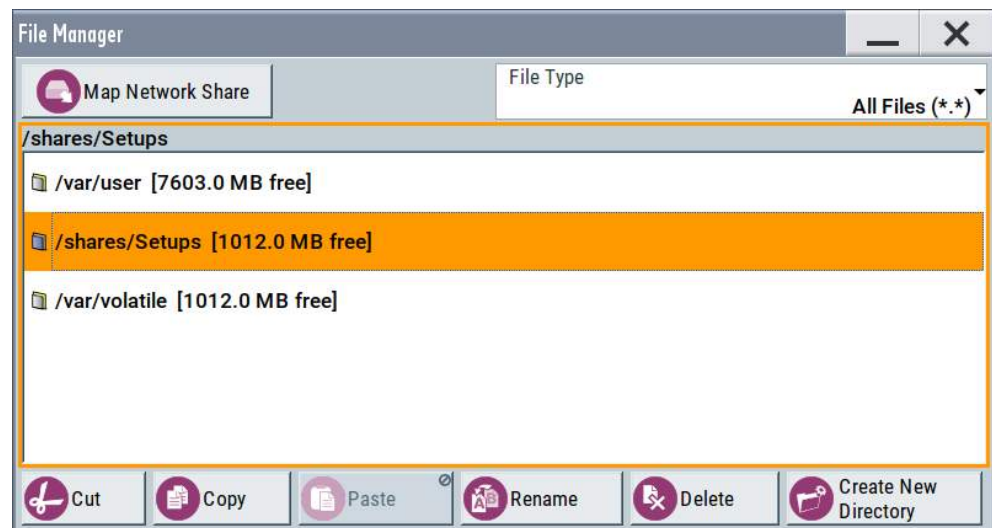

If the connection does not succeed, consider to check the following:

- Is the network folder or computer you try to map turned on?
- Is the network folder or computer enabled for remote access?
- Does the selected user name have the necessary permissions?

See also [Chapter 9.9.5, "Using a File Server for Test Files Exchange"](#), on page 473.

9.9 How to Transfer Files from and to the Instrument

As explained in ["File handling"](#) on page 444, you access the file system of the R&S SMBV100B via one of the following ways:

- Via the built-in "File Manager"
See [Chapter 9.8, "Using the File Manager"](#), on page 462.
- On an instrument connected to a LAN:
 - Via one of the standard functions ftp or SMB (samba)
See [Chapter 9.9.2, "Accessing the File System of the R&S SMBV100B Via ftp"](#), on page 470 and
[Chapter 9.9.3, "Accessing the R&S SMBV100B File System Via SMB \(Samba\)"](#), on page 471
 - Via mapped network drives
See [Chapter 9.8.4, "How to Map a Network Folder"](#), on page 466.
- Via a connected USB storage device
See [Chapter 9.9.4, "Using a USB Storage Device for File Transfer"](#), on page 473

Mainly because of security reasons, the access to the file system of your R&S SMBV100B can be denied, because one or all these access methods are deliberately disabled. Access to the file system via LAN and/or USB requires that the corresponding service is enabled and a write access to the file system is enabled. Refer to

[Chapter 9.9.1, "Removing File System Protection"](#), on page 469 for description of the required steps.

This section provides an introduction to the topic. For comprehensive information, refer to the application note [1GP72: Connectivity of Rohde&Schwarz Signal Generators](#).

- [Removing File System Protection](#)..... 469
- [Accessing the File System of the R&S SMBV100B Via ftp](#)..... 470
- [Accessing the R&S SMBV100B File System Via SMB \(Samba\)](#)..... 471
- [Using a USB Storage Device for File Transfer](#)..... 473
- [Using a File Server for Test Files Exchange](#)..... 473

9.9.1 Removing File System Protection

Before you try to access the file system via ftp, SMB (samba) or USB, fulfill the following:

- Disable write protection on the file system
- Enable the corresponding service or interface

To enable write permission on the file system

1. Select "System Config > Setup > Security > Security > General"
2. Enable "Volatile Mode"
3. Enter the "Security Password".
The default password is 123456. For more information, see [Chapter 10.5, "Using the Security Settings"](#), on page 505.
4. Select "System Config > Setup > Maintenance > Shut Down"
5. Select "Reboot".
The system reboots. The enabled settings are active.

To enable file transfer via ftp

1. Select "System Config > Setup > Security > Security > LAN Services".
2. Enable "LAN Interface"
3. Enable "FTP"
4. Enter the "Security Password".
The default password is 123456. For more information, refer to [Chapter 10.5, "Using the Security Settings"](#), on page 505.
5. Select "Accept".

To enable file transfer via SMB (samba)

1. Select "System Config > Setup > Security > Security > LAN Services"
2. Enable "LAN Interface"

3. Enable "SMB (Samba)"
4. Enter the "Security Password".
The default password is 123456. For more information, refer to [Chapter 10.5, "Using the Security Settings"](#), on page 505.
5. Select "Accept".

To enable file transfer via USB

1. Select "System Config > Setup > Security > Security > General"
2. Enable "USB Storage"
3. Enter the "Security Password".
The default password is 123456. For more information, refer to [Chapter 10.5, "Using the Security Settings"](#), on page 505.
4. Select "Accept".

9.9.2 Accessing the File System of the R&S SMBV100B Via ftp

If the R&S SMBV100B is connected to a LAN, you can use file transfer protocol (ftp) to access the file system and to transfer files from and to the instrument.

For information on how to set up a LAN connection, refer to:

- [Chapter 2.1.4, "Setting Up a Network \(LAN\) Connection"](#), on page 37
- [Chapter 11, "Network Operation and Remote Control"](#), on page 520

To access the file system via ftp

We assume that the instrument and the remote PC are connected to a LAN.

1. [Enable file transfer via ftp](#)
2. [Enable write permission on the file system](#)
3. On the remote PC, start the Windows Explorer.
4. In the address field, enter `ftp://<"IP Address" of the Instrument>`, e.g. `ftp://10.124.0.166`.

Tip: The R&S SMBV100B indicates its IP address on the block diagram.

A log-on dialog opens and requests a password.

The default user name and password is *instrument*.

Tip:**Default password**

The FTP and SAMBA file access use the user "instrument" with default password "instrument".

We recommend that you change this password in the "Setup > Security > Password Management > Change User Password" dialog before connecting the instrument to the network.

See [Chapter 10.5.4, "Password Management"](#), on page 515.

5. Enter the password to access the `user` directory.
The `user` directory corresponds to the `/var/user/` directory of the instrument.

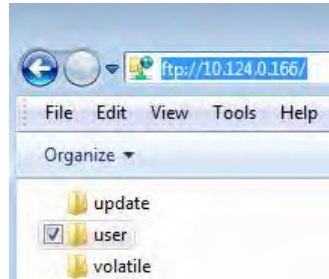

There, you can perform standard functions like creating directory, or saving files.

6. In the `user` directory, create a directory, e.g. `test ftp`.
7. Select Save/Rcl.

Open the `/var/user/` directory.

The dialog displays the `/var/user/test ftp` directory.

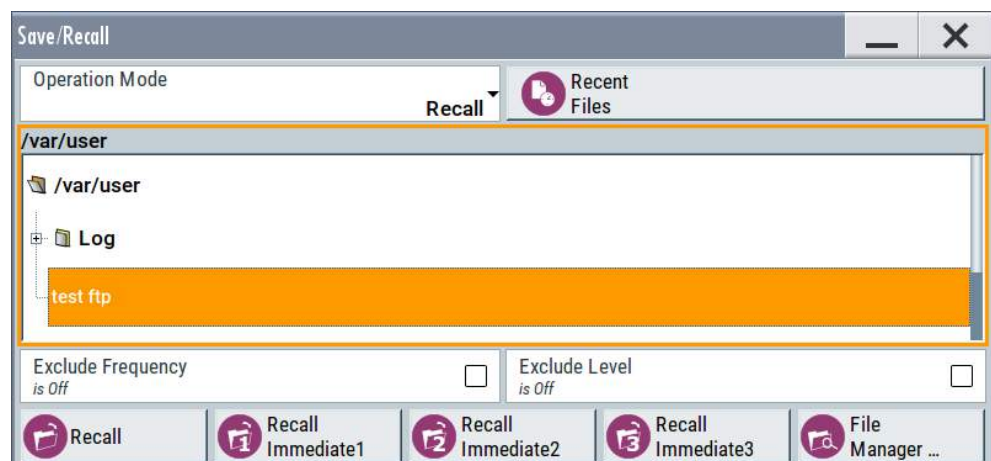

9.9.3 Accessing the R&S SMBV100B File System Via SMB (Samba)

The SMB (Samba) protocol is an alternative way to access the file system of the instrument from a remote PC. This protocol works if both the instrument and the PC are connected to a LAN.

For information on how to set up a LAN connection, refer to:

- [Chapter 2.1.4, "Setting Up a Network \(LAN\) Connection"](#), on page 37
- [Chapter 11, "Network Operation and Remote Control"](#), on page 520

To access the file system via SMB

We assume that the instrument and the remote PC are connected to a LAN.

1. [Enable file transfer via ftp](#)

2. [Enable write permission on the file system](#)
3. On the remote PC, start the Windows Explorer.
4. In the address field, enter //["<IP Address" of the Instrument>](#), e.g. `ftp://10.124.0.166`.

Tip: The R&S SMBV100B indicates its IP address on the block diagram.

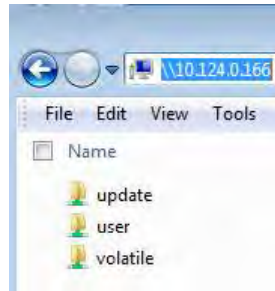

The `user` directory corresponds to the `/var/user/` directory of the instrument; the `volatile` directory - to the `/var/volatile` directory.

To map the R&S SMBV100B as a network drive to the remote PC

We assume that the instrument and the remote PC are connected to a LAN.

1. [Enable file transfer via SMB \(Samba\)](#)
2. [Enable write permission on the file system](#)
3. On the remote PC, start the Windows Explorer.
Open the "Map Network Drive" dialog.
 - a) Select a valid "Drive", e.g. *W*.
 - b) In the "Folder" field, enter //["<IP Address" of the Instrument>/user](#) or //["<Hostname" of the Instrument>/user](#)
For example: `//10.124.0.166/user` or `//SMBV100B-102030/user`.
Tip: The R&S SMBV100B indicates its IP address on the screen.
 - c) Select "Finish".

A log-on dialog opens and requests a user name and a password.

The default user name and password is *instrument*.

Tip:

Default password

The FTP and SAMBA file access use the user "instrument" with default password "instrument".

We recommend that you change this password in the "Setup > Security > Password Management > Change User Password" dialog before connecting the instrument to the network.

See [Chapter 10.5.4, "Password Management"](#), on page 515.

4. Enter the user name and the password of your instrument.

The `/var/user/` directory of the instrument is mapped to and displayed as a network drive of the remote PC.

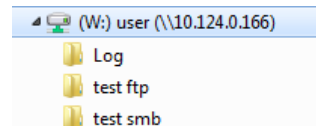

You can access the files in the `/var/user/` directory, perform standard function like creating directory, or storing files.

9.9.4 Using a USB Storage Device for File Transfer

Alternatively to the file transfer possibility via LAN, you can use a USB storage device for direct file transfer from and to the instrument.

We recommend that you transfer files with user data (like lists or instrument setup files) to the instrument, rather than load and play them from a connected USB storage device.

To transfer a file with user data to the instrument

1. Connect a USB storage device, for example a USB memory stick to one of the USB interfaces of the instrument.

The R&S SMBV100B recognizes the connected USB storage device automatically.

2. [Enable file transfer via USB](#)
3. [Enable write permission on the file system](#)
4. Select Save/Rcl.

The dialog displays the `/var/user/` directory and the `/usb/` drive.

5. In the "Save/Recall" dialog, select "File Manager".
6. In the directory tree, navigate to the `/usb/` drive.
Select the required file with user data.
7. Select "Copy".
8. In the directory tree, navigate to the `/var/user/` directory.
Select "Paste".

The file with user data is transferred to the instrument.

9.9.5 Using a File Server for Test Files Exchange

You can use a central file storage location like a file server in your company network to store setup files, SCPI scripts, application programs, or waveform files on it. Usually,

you would like to distribute the files to several instruments. If the R&S SMBV100Bs are connected to a LAN, you can create a shortcut on the instruments to the file server.

To access the file server

1. On each R&S SMBV100B, map the required directory of the file server to the instrument.
Perform the steps described in [Chapter 9.8.4, "How to Map a Network Folder"](#), on page 466.
2. On each R&S SMBV100B, use the same alias name for the directory of the file server, i.e. enter the same "Local Folder" (in this example *Setups*).

On any of the R&S SMBV100B, you access the file server directly from the "File Manager" and under the same name, e.g. `/shares/Setups`.

An extra advantage in remote control is that the same application program would control the instruments.

For example, use the remote control command `MMEemory:CDIRECTory "/shares/Setups"` to set the default directory for mass storage.

9.10 Creating Screenshots of Current Settings

The save/recall function enables you to save current settings in a file. To document the most important settings for a performed signal generation, you can also save a hardcopy of the current display.

- [Hardcopy Settings](#).....474
- [How to Save a Hardcopy of the Display](#).....478

9.10.1 Hardcopy Settings

Access:

- ▶ Select "System Config > Setup > User Interface > Hardcopy".

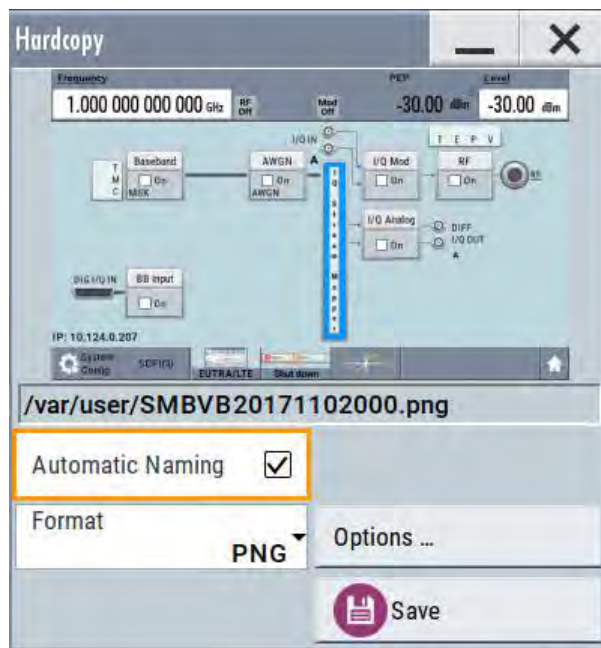

The remote commands required to define these settings are described in [Chapter 12.11, "HCOPY Subsystem"](#), on page 611.

Settings:

Automatic Naming.....	475
File.....	475
Format.....	476
Options.....	476
Save.....	476
Hardcopy Options > Common.....	476
L Automatic Naming.....	476
L Format.....	476
L Region.....	476
Hardcopy Options > Automatic Naming.....	477
L Path.....	477
L Clear Path.....	477
L Prefix, Year, Month, Day.....	477
L Current Auto Number.....	478

Automatic Naming

If enabled, creates the output filenames automatically according to the rules set with the [Hardcopy Options > Automatic Naming](#) settings.

Remote command:

:HCOPY:FILE[:NAME]:AUTO:STATE on page 615

File...

In "Automatic Naming > Off" mode, accesses the standard file select dialog for selecting the filename and folder the hardcopy is stored in.

If you have enabled "Automatic Naming", the instrument displays the automatically generated filename.

Remote command:

`:HCOPY:FILE[:NAME]` on page 613

Format

Selects the output file format, for example *.bmp, *.jpg*.xpm and *.png.

Remote command:

`:HCOPY:IMAGE:FORMAt` on page 613

`:HCOPY:DEVIce:LANGUage` on page 613

Options...

Accesses [Hardcopy Options](#) dialog.

Save

Saves a hardcopy of the current display as a file.

Remote command:

`:HCOPY[:EXECute]` on page 614

Hardcopy Options > Common

Access: select "Hardcopy > Options... > Common".

With the provided settings, you can customize the file format and the syntax of the automatically assigned filename.



Automatic Naming ← Hardcopy Options > Common

If enabled, creates the output filenames automatically according to the rules set with the [Hardcopy Options > Automatic Naming](#) settings.

Remote command:

`:HCOPY:FILE[:NAME]:AUTO:STATe` on page 615

Format ← Hardcopy Options > Common

Selects the output file format, for example *.bmp, *.jpg*.xpm and *.png.

Remote command:

`:HCOPY:IMAGE:FORMAt` on page 613

`:HCOPY:DEVIce:LANGUage` on page 613

Region ← Hardcopy Options > Common

Displays the snapshot area.

Remote command:

[:HCOPY:REGion](#) on page 613

Hardcopy Options > Automatic Naming

Access: select "Hardcopy > Options... > Automatic Naming".

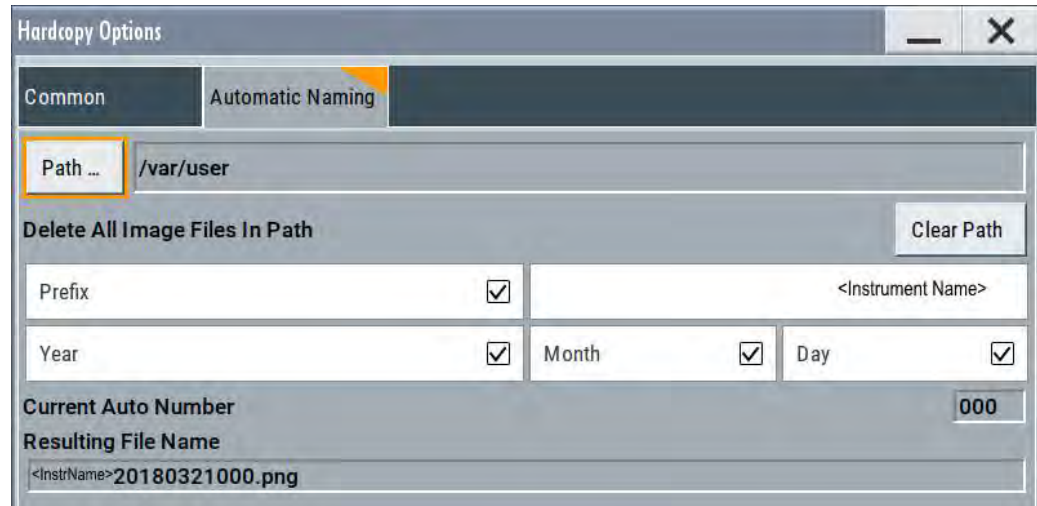

Provided are the following settings:

Path... ← Hardcopy Options > Automatic Naming

Selects the directory.

Note: To select the destination path, specify also a filename. Otherwise an error message is displayed and selection is canceled.

Remote command:

[:HCOPY:FILE\[:NAME\]:AUTO:DIRectory](#) on page 614

Clear Path ← Hardcopy Options > Automatic Naming

Deletes all image files with extensions *.bmp, *.jpg, *.png and *.xmp in the directory set for automatic naming.

Before the command is executed, a warning message prompts you to confirm the deletion of the files.

Remote command:

[:HCOPY:FILE\[:NAME\]:AUTO:DIRectory:CLEar](#) on page 615

Prefix, Year, Month, Day ← Hardcopy Options > Automatic Naming

Determines the rules for "Automatic Naming".

Per default, the automatically generated filename is composed of:

<Path>/<Prefix><YYYY><MM><DD><Number>.<Format>, where Y, M and D mean year, month, Day; Number is the [Current Auto Number](#).

You can activate or deactivate each component separately.

The "Resulting filename" indicates the current filename syntax.

Remote command:

:HCOPY:FILE[:NAME]:AUTO[:FILE]:PREFIX on page 616

:HCOPY:FILE[:NAME]:AUTO[:FILE]:PREFIX:STATE on page 616

:HCOPY:FILE[:NAME]:AUTO[:FILE]:YEAR:STATE on page 615

:HCOPY:FILE[:NAME]:AUTO[:FILE]:MONTH:STATE on page 615

:HCOPY:FILE[:NAME]:AUTO[:FILE]:DAY:STATE on page 615

Current Auto Number ← Hardcopy Options > Automatic Naming

Indicates the number which is used in the automatically generated filename.

Note: When initially switching on the instrument, the number is reset to the lowest possible value. Starting with number 0 the output directory is scanned for existing files. As long as files with the same name are existing, the number is increased by 1. The number is automatically set so that the resulting filename is unique within the selected path. The current number is not in the save/recall file but is temporarily stored within the database. At the following save operation, the number is increased.

Remote command:

:HCOPY:FILE[:NAME]:AUTO[:FILE]:NUMBER? on page 616

9.10.2 How to Save a Hardcopy of the Display

1. Select "System Config > Setup > User Interface > Hardcopy".

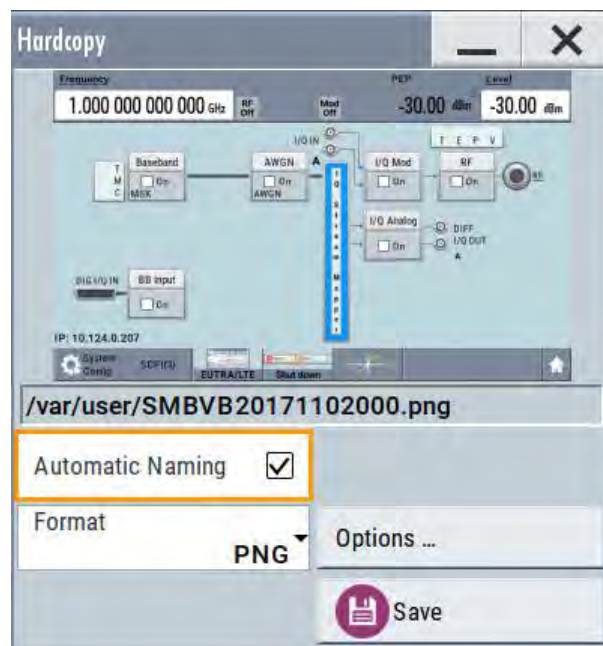

2. To define the output format, select "Format > JPG".
3. To enable the instrument to create output filenames, select "Automatic Naming > On".
4. Select "Options...".

5. In the "Hardcopy Options" dialog:
 - a) To change the default directory the file is saved in, select "Automatic Naming Settings > Path" and define a path and a filename. For example, select the default directory `/var/user`.
 - b) If necessary, disable or change some of the parameters in the "Automatic Naming Settings".
 - c) Close the "Hardcopy Options" dialog.
6. In the "Hardcopy" dialog, select "Save".

The instrument saves a hardcopy of the current instrument display as a `*.jpg` file. The filename is automatically created.
7. To print the hardcopy, connect the instrument to a LAN and:
 - a) Transfer the file to a remote computer as described in [Chapter 9.9, "How to Transfer Files from and to the Instrument"](#), on page 468.
 - b) On the remote computer, navigate through the file system.
 - c) Print the selected file.

For more information, refer to the online help of the operating system.

10 General Instrument Functions

The general instrument functions include basic instrument settings, regardless of the selected operating mode and measurement. Some of these settings like screen display and peripherals are initially configured at the setup of the instrument, according to personal preferences and requirements. However, you can individually adjust the settings at any time, for example, for specific applications.

The following special functions help you in service and basic system configuration:

- [Chapter 10.1, "Customizing the User Interface"](#), on page 480
Allows you to adjust the display and keyboard language settings.
- [Chapter 10.2, "Configuring the Global Connectors"](#), on page 486
Allows you to map internal or external signals to the multipurpose connectors.
- [Chapter 10.3, "Organizing Frequently Used Settings as Favorites"](#), on page 496
Allows you to assign user defined actions to the user key.
- [Chapter 10.4, "Managing Licenses and License Keys"](#), on page 501
If you have purchased an additional option for the R&S SMBV100B, you can enable it using a license key.
- [Chapter 9.2, "Restoring the \(Default\) Instrument Configuration"](#), on page 445
At any time, you can restore a default configuration to start a measurement at a defined instrument state, or set the instrument to factory preset.
- [Chapter 13.3, "Performing Maintenance Tasks"](#), on page 921
Special functions like calibration routines and selftests put your instrument to an initial state.
- [Chapter 10.5, "Using the Security Settings"](#), on page 505
Special security and protection functions protect your instrument from unauthorized use or activate specific test routines.

10.1 Customizing the User Interface

The R&S SMBV100B provides basic alignments of instrument settings regarding the user interface, that means the touch panel (screen), the appearance of the displayed dialogs and graphics, and an external keyboard.

Dialog snapshots

The R&S SMBV100B enables you to disable the snapshots of dialogs in the taskbar and replaces dialogs with test. For information on how to deactivate the snapshot preview, see [Chapter 10.1.2, "Appearance Settings"](#), on page 483.

Start / stop display update

The operating system of the R&S SMBV100B refreshes the displayed settings by default in almost real-time, to keep the display updated with the internally used values. However, you can turn off this function to reduce settling times when the instrument is remote controlled.



We recommend that you switch off the display update for optimum sweep performance with short dwell times and for fast settling times.

Consider that in this case the displayed values can differ from the operated values.

In detail described in the following paragraphs, you can:

- Set display and keyboard language, see [Chapter 10.1.1, "Display and Keyboard Settings"](#), on page 481
- Customize the GUI appearance, see:
 - [Dialog snapshots](#)
 - [Chapter 10.1.2, "Appearance Settings"](#), on page 483
- Set date and time for the system clock, see [Chapter 13.3.1, "Date and Time Settings"](#), on page 922
- Configure and activate a [Screen Saver](#)
- Deactivate display update to improve performance, see [Chapter 10.1.3, "Display Update Settings"](#), on page 483
- Determine the state of the RF signal, and the level display in the status bar when you turn on the R&S SMBV100B, see [Chapter 10.1.4, "Defining the RF Signal State On Power On"](#), on page 484.

10.1.1 Display and Keyboard Settings

Access:

1. Select "System Config > Setup > User Interface > Display/Keyboard > Display".

Display	USB Keyboard
Screen Saver <i>is Active</i>	<input checked="" type="checkbox"/> Wait time 10 Min
Brightness	
Display 14	RF Hardkey 14

2. Select "Display/Keyboard > USB Keyboard".

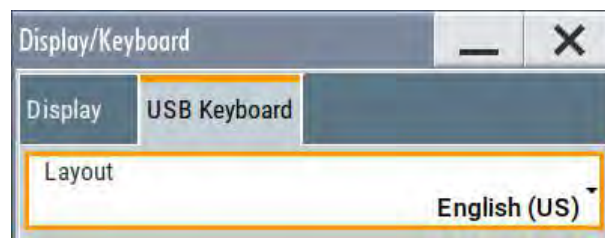

In the "Display/Keyboard" dialog, you can change regional and language options for the GUI and an external keyboard, and define the screen saver settings.

The remote commands required to configure the display and keyboard are described in [Chapter 12.9, "DISPlay Subsystem"](#), on page 605 and [Chapter 12.12, "KBOard Subsystem"](#), on page 616.

Screen Saver	482
Wait Time	482
Display	482
RF Hardkey	482
USB Keyboard > Layout	483

Screen Saver

Activates the screensaver.

If activated, the display including backlight is switched off after the selected [Wait Time](#) elapses and if no entries via touch panel, front panel, external mouse, or external keyboard are made

Remote command:

[:DISPlay:PSAVe\[:STATe\]](#) on page 606

Wait Time

Enters the idle time that must elapse before the display lamp is shut off when no entries are made.

Remote command:

[:DISPlay:PSAVe:HOLDoff](#) on page 606

Display

Adjusts the brightness of the display.

Increase the value to turn up the display brightness.

Remote command:

[:DISPlay:BRIGhtness](#) on page 607

RF Hardkey

Adjusts the brightness of the [RF on/off] key.

Increase the value to change the contrast between the key and the front panel background color.

Remote command:

[:DISPlay:BUtTon:BRIGhtness](#) on page 607

USB Keyboard > Layout

Selects the language of an externally connected keyboard via USB. The function assigns the corresponding keys automatically.

Remote command:

:KBOard:LAYout on page 617

10.1.2 Appearance Settings

Access:

- ▶ Select "System Config > Setup > User Interface > Appearance".

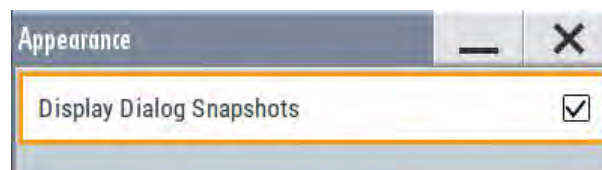

In this dialog, you can set inactive dialog opaque and enable the display of dialog snapshots.

[Display Dialog Snapshots](#)..... 483

Display Dialog Snapshots

Displays thumbnails of open dialogs in the task bar.

10.1.3 Display Update Settings

Access:

- ▶ Select "System Config > Setup > User Interface > Start/Stop Display Update".

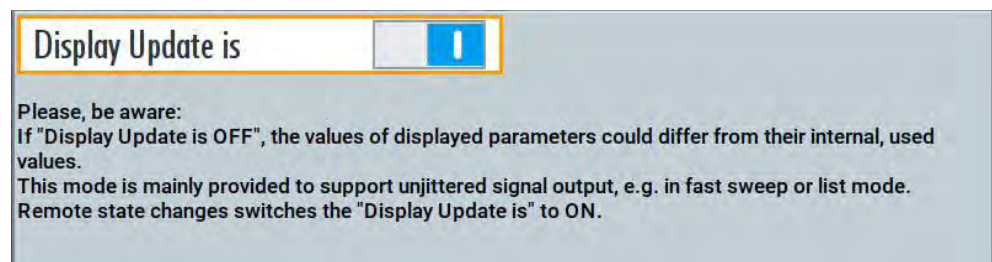

This dialog enables you, to deactivate updating the display.

The remote command to switch off the display update is described in [Chapter 12.9, "DISPlay Subsystem"](#), on page 605.

Display Update is

Disables the automatic refreshing of the displayed values.

Remote command:

:DISPlay:UPDate on page 607

10.1.4 Defining the RF Signal State On Power On

As additional functions for the level settings, you can determine the state of the RF signal, and the level display in the status bar when you turn on the R&S SMBV100B.

Power-On/EMF settings

Access:

- ▶ Select "RF" > "RF Level" > "Power-On / EMF".



The "Power-On/EMF" dialog contains all settings for configuring the power-on behavior and the level display.

Settings:

Power-On State	484
Display Level as Voltage of EMF	484

Power-On State

Determines the RF signal output state when the instrument is switched on.

You can disable the RF output signal in general, or start it in the same state as it had been when it was switched off.

Remote command:

:OUTPut<hw>[:STATe]:PON on page 618

Display Level as Voltage of EMF

Activates display of the signal level as voltage of the EMF (no-load voltage).

If disabled, the level is displayed as a voltage over a 50 Ohm load.

Note:

The setting is not affected by an instrument preset ([Preset] key or *RST) and the "Save/Recall" function. It is reset only by factory preset.

Remote command:

[:SOURce<hw>]:POWer:EMF:STATe on page 863

10.1.5 How to Set the Initial Instrument Settings

This section describes how to set up the R&S SMBV100B initially.

10.1.5.1 Setting the Keyboard Language

You can select the language of the external keyboard connected to the instrument.

To adjust the keyboard settings

1. Press the [Setup] key.
2. Select "User Interface > Keyboard".

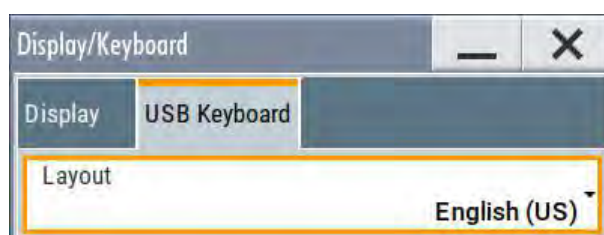

3. Select the "Layout".

The dialog closes and the changes take effect immediately.

10.1.5.2 Setting the Screen Saver

You can enable a screen saver that automatically turns off the display after a user-defined period of time. The screen saver is activated if no settings are made on the touch screen, or via keys or the rotary knob during the selected wait time.

To activate the screen saver

1. Press the [Setup] key.
2. Select "User Interface > Display"
3. Activate the "Screen Saver".

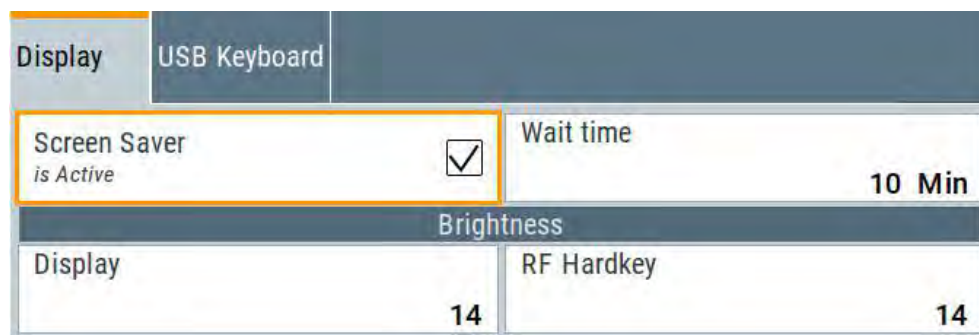

4. Define the "Wait Time" in minutes.

The instrument turns off the display after the defined period of time.

5. To reactivate the display, tap the screen or press any key on the front panel.

To deactivate the screen saver

1. Press the [Setup] key.
2. Select "User Interface > Display"
3. Disable the "Screen Saver" state.

10.1.5.3 Adjusting Appearance of the User Interface

You can disable the snapshot preview of dialog in the taskbar .

1. Press the [Setup] key.
2. Select "User Interface > Appearance".
3. If necessary, enable "Display Dialog Snapshots".

The changes take effect immediately.

10.2 Configuring the Global Connectors

The R&S SMBV100B is equipped with multipurpose bi-directional connectors.

Grouped according to their impact on the baseband or on the RF signal, the same connectors are divided into:

- [Chapter 10.2.3, "Trigger Marker Clock Settings"](#), on page 488
- [Chapter 10.2.4, "RF Connectors Settings"](#), on page 490

10.2.1 Required Options

The R&S SMBV100B is always equipped with five User interfaces.

Additional options are not required.

10.2.2 About the Global Connectors

Signal to Connector Mapping

As described in [Chapter 3.4.1, "Basics on Signals, Modulation Types and Filters Used the Baseband Domain"](#), on page 89, the R&S SMBV100B uses several internally generated and externally supplied signals. To handle these signals, the R&S SMBV100B introduces the concept of signal to connector mapping. The available signals are not dedicated to a particular connector but can be mapped to one or more User connectors.

The signal mapping and the polarity, the trigger threshold, and the input impedance of the input connectors are configurable parameters. The connectors settings are grouped in the [Global Connectors Settings](#) dialog.



For an overview of the required configuration steps, refer to "[General Workflow](#)" on page 495.

10.2.2.1 Global Connectors

The R&S SMBV100B is equipped with User x interfaces which can be freely assigned a selection of signals and which can be configured as both inputs and outputs.

A common threshold and input impedance is effective for all trigger and clock signal inputs provided at the User connectors. The settings influence the custom digital modulations, the generation of waveforms or multicarrier signals, and all digital standards.

The R&S SMBV100B is also equipped with Inst Trig connector. The instrument trigger setting influences all sweeps and is effective in the List mode.

See [Chapter 6.10, "Varying the RF Signal in List or Sweep Mode"](#), on page 284.

The [Table 10-1](#) gives an overview of the signals that can be applied to and output at the User connector.

Table 10-1: Mapping control signals to the User x connectors

Connector	Direction	Assigned Signal	Remark
User x	Input	"Global Trigger" "Global Clock" "Global Next Segment" "Baseband Sync In" "Data"	
User x	Output	"Baseband Marker 1/2/3" "Baseband Sync Out" "Symbol Clock" "Lev Att" "Burst Gate" "Hop" "CW/Mod" "Triggered"	
User 5	Output	"Manual Trigger"	

10.2.2.2 Trigger, Marker, Clock and RF Connectors

The [Trigger Marker Clock Settings](#) and [RF Connectors Settings](#) dialogs provide an overview of the current mapping of the logical signals to the corresponding connectors. The dialogs are summary representation of related settings, as configured with the [Global Connectors Settings](#) settings.

10.2.2.3 Status Indicators

Connector status indication

A dedicated LED indicates the connector status:

- Green: an input connector
- Yellow: an output connector
- No light: the connector is not active

T/M/C status LEDs



For quick overview of the source (internal/external) of the used trigger, marker and clock signals, the block diagram displays *T/M/C status LEDs* on the left side of the "Baseband" block.

If the baseband generator is active, the displayed information is color coded, where:

- A green LED indicates that an external signal is used
- A yellow LED confirms that the signal is available at the output connector

T/E/L/P/V status LEDs

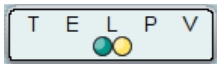

For quick overview of the source (internal/external) of the control signals, the block diagram displays *T/E/L/P/V status LEDs* on the top/bottom of the "RF" blocks.

If the RF block is active, the displayed information is color coded, where:

- A green LED indicates that an external signal is used
- A yellow LED confirms that the signal is available at the output connector.

The signal valid (V) and the pulse signal (P) indications are displayed if the corresponding function is enabled ("RF > On" and "Pulse Modulator > State > On").

10.2.3 Trigger Marker Clock Settings

Access:

1. Perform one of the following:
 - In the "Block Diagram", select the [T/M/C status LEDs](#) on the left side of the "Baseband" blocks.
 - Select "Baseband > Trigger Marker Clock".

The "Trigger Marker Clock" gives an overview of the current mapping of the logical signals to the connectors, as configured in the [Global Connectors](#) dialog. Clicking the connector name directly accesses the related connector settings.

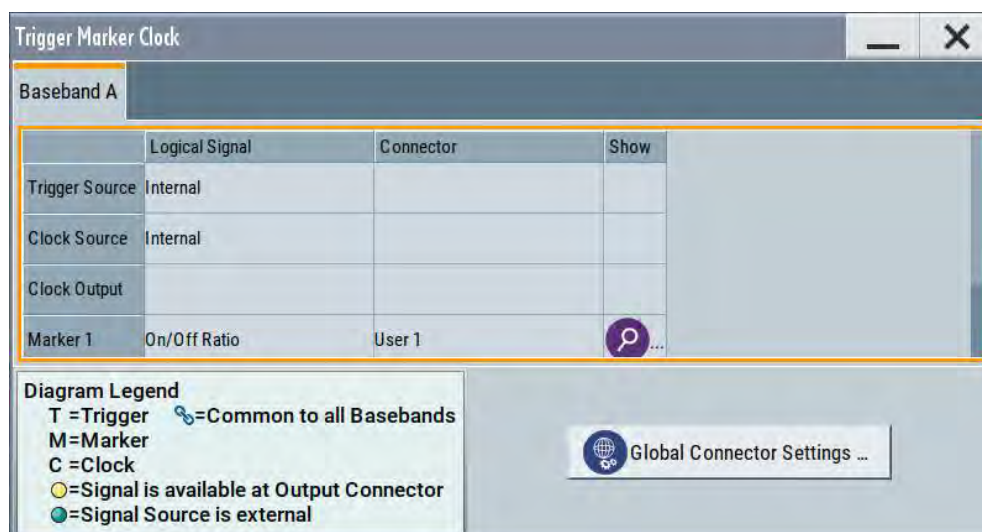

- Use the built-in [Show Connector](#) function to display the physical location of the selected connector.

A blinking LED on the rear panel indicates the selected connector, too.



The eye icon in the tab header indicates the panel (front, rear or both) the selected connector is located at.

10.2.3.1 Overview Table

Logical Signal

Displays the logical signal, as configured in the "Trigger In", "Marker" or "Clock" tab of the corresponding digital standard, see for example [Chapter 3.4.2.1, "Trigger Settings"](#), on page 110.

Connector

Displays the assigned connector.



Show Connector

Accesses a dialog that displays the physical location of the selected connector on the front/rear panel of the instrument.

10.2.3.2 Global Connector Settings

Each of the "Trigger In", "Marker" and "Clock" dialogs as well as the "Trigger Marker Clock" dialog provides a quick access to the related connector settings.



For more information, refer to the description R&S SMBV100B user manual, section "Global Connector Settings".

10.2.4 RF Connectors Settings

Access:

1. Perform one of the following:
 - In the "RF block", select "RF > RF Frequency > Connectors".
 - In the "control signal block" next to the RF block, select [T/E/L/P/V status LEDs](#).

The "RF Connectors" dialog gives an overview of the mapping of the logical signals to the connectors; the displayed connectors depend on the installed options. The signal assignment to the dedicated RF connectors, for example LO In/Out or Inst Trig, is fixed.

Selecting a connector name accesses directly the related connector settings.

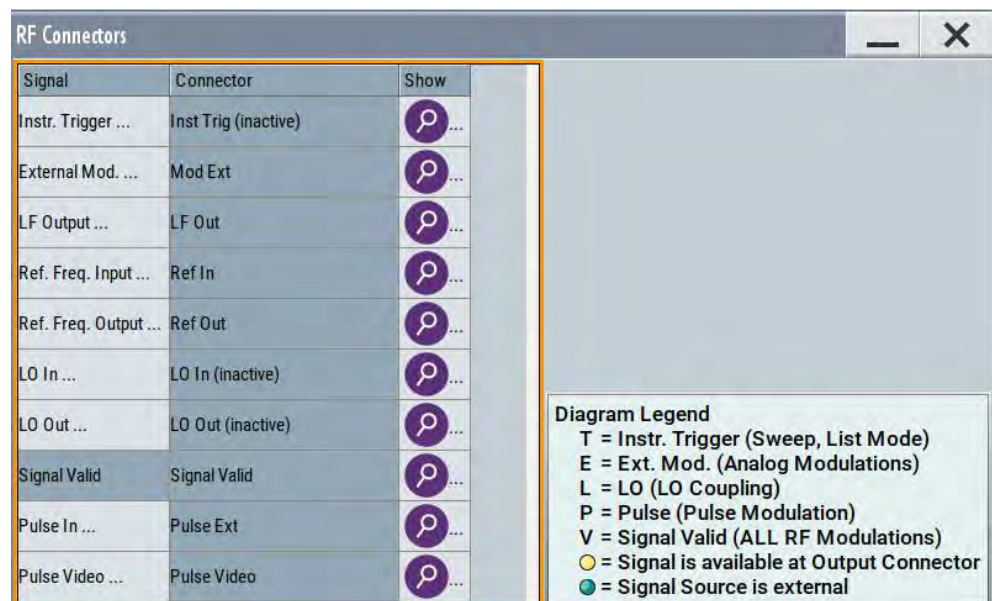

2. Select the "Signal" name to access the dialog with respective settings.

- Use the built-in **Show Connector** function to display the physical location of the selected connector.



The eye icon  in the tab header indicates the panel (front, rear or both) the selected connector is located at.

Settings:

Signal.....	491
Connector.....	491
Show Connector.....	491

Signal

Opens the dialog with the corresponding settings.

Connector

Displays the assigned connector.



Show Connector

Accesses a dialog that displays the physical location of the selected connector on the front/rear panel of the instrument.

10.2.5 Global Connectors Settings

Access:

- Perform one of the following:
 - In the "Block Diagram", select the **T/M/C status LEDs** to access the "Trigger Marker Clock" dialog and:
 - Select a User connector or
 - Select "Global Connector Settings".

- Select "Baseband > Custom Digital Modulation > Trigger In > Global Connector Settings" or respectively the "Trigger In", "Marker" or "Clock" tab of the corresponding digital standard.

The "Global Connectors" dialog comprises the settings necessary to configure the signal to connector routing and the physical characteristics of the input connectors for trigger, clock and control signals.

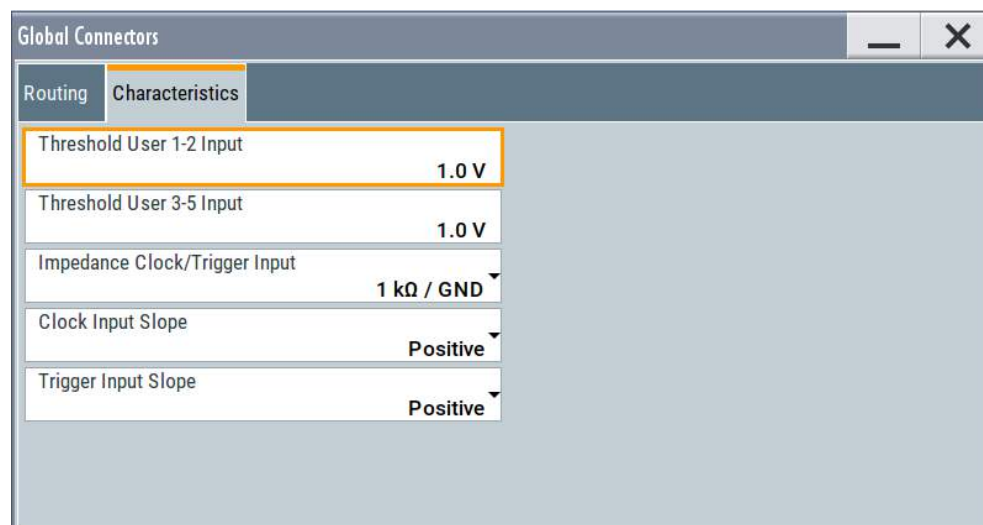
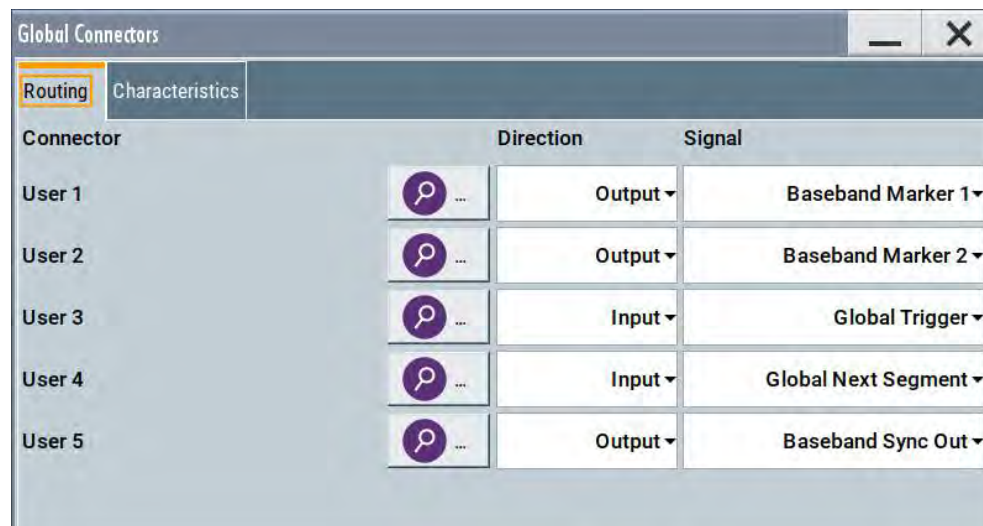

2. Use the built-in [Show Connector](#) function to display the physical location of the selected connector.

A blinking LED on the rear panel indicates the selected connector, too.



Show Connector

Accesses a dialog that displays the physical location of the selected connector on the front/rear panel of the instrument.

User x Connector Direction

Determines whether the connector is used as an input or an output.

A connector with not specified direction is in a "Not Used" state.

Remote command:

[\[:SOURce\]:INPut:USER<ch>:DIRection](#) on page 649

[:OUTPut:USER<ch>:DIRection](#) on page 649

Signal

Determines the control signal that is input or output at the selected connector. Whether the connector is used as an input or an output is selected by the parameter [Direction](#)

The [Table 10-1](#) lists the available control signals.

"Global Trigger"

Input for triggering custom digital modulations, digital standards and ARB. A trigger event affects the signal generation in all basebands for which the "Global Trigger" signal is enabled.

"Global Clock"

Input for external clock signal for synchronizing the internal clocks in all basebands to an externally applied clock signal. The active edge can be configured.

"Global Next Segment"

Input next segment for triggering of multi-segment waveform files (see [Chapter 3.7, "Generating Multi-Segment Waveform Files"](#), on page 167).

"Baseband Marker 1/2/3"

Marker signal output for triggering and control of external devices with user-definable marker signals.

"Baseband Sync Out/Baseband Sync In"

Signals available in enabled [master-slave](#) mode.

- "Baseband Sync Out"
One or more outputs of a dedicated synchronization (and trigger) signal, that has to be fed into the slave instruments.
- "Baseband Sync In"
In the slave instruments, at most one input for the synchronization (and trigger) signal.
Can be assigned to any global connector.

See also [Chapter 8.3.1, "Connecting Multiple Instruments in Master-Slave Mode"](#), on page 399.

"Symbol Clock"

Output of the internal clock signal used for digital modulations. The signal is generated automatically when the standard is switched on.

"Lev Att"

Output signal that determines whether the signal level is attenuated, if envelope curve control is active.

The internal "Lev Att" control signal is defined in a control list and activated in the "Baseband > Custom Digital Modulation > Power Ramp Control" dialog.

See also [Chapter 3.5.3.8, "Control and Marker Lists Editor"](#), on page 130.

"Burst Gate"

Output for control signal for envelope curve control.
This control signal is defined in a control list and activated in the "Baseband > Custom Digital Modulation > Power Ramp Control" dialog.
See also [Chapter 3.5.3.8, "Control and Marker Lists Editor"](#), on page 130.

"Hop"

Marks the hop trigger for frequency hopping in the List mode for "Custom Digital Modulation". The hop signal is defined in a control list and activated by loading the control list, see [Chapter 3.5.3.8, "Control and Marker Lists Editor"](#), on page 130.

"CW/Mod"

Output signal to indicate the output of RF signal in unmodulated form (digital modulation is deactivated).
This control signal is defined in a control list, see [Chapter 3.5.3.8, "Control and Marker Lists Editor"](#), on page 130.

"Triggered"

Output of the internal or the received external trigger signal.

"Manual Trigger"

Output of a short pulse signal that can serve as a common external trigger signal for triggering of several R&S SMBV100B.
See [Example "Triggering several R&S SMBV100B instruments simultaneously"](#) on page 405.

"Always 0/Always 1"

Control signal with low or high level.

"None"

No signal is assigned to the connector.

Remote command:

[\[:SOURce\]:INPut:USER<ch>:SIGNa1](#) on page 649

[\[:OUTPut:USER<ch>:SIGNa1](#) on page 649

Execute Trigger

If "User 5 > Direction = Output" and "Signal = Manual Trigger", generates a short pulse signal and outputs it at the User 5 connector.

The signal can serve as a common external trigger signal for triggering of several R&S SMBV100B, see [Example "Triggering several R&S SMBV100B instruments simultaneously"](#) on page 405.

Remote command:

[\[:OUTPut:USER<ch>:TRIGger\[:IMMediate\]](#) on page 650

Threshold User1-2 Input

Sets the high/low threshold in volts for the signal at the User1-2 connectors.

The input signal is defined with the parameter [Signal](#). The same threshold applies for both connectors and any input signal.

Remote command:

[\[:SOURce\]:INPut:USER:TRIGger:LEVel](#) on page 650

[\[:SOURce\]:INPut:USER:CLOCK:LEVel](#) on page 650

Threshold User3-5 Input/Threshold Pulse Input

Sets the high/low threshold in volts for the signal at the User3-5 connectors.

The input signal is defined with the parameter [Signal](#). The same threshold applies for all 3 connectors and any input signal (e.g. external pulse modulation or trigger signal).

Remote command:

`[:SOURce] : INPut : USER : PULM : LEVel` on page 651

Impedance Clock/Trigger Input

Selects the input impedance for the external trigger/clock inputs.

Set the value to 1 k Ω /GND for high clock rates.

Remote command:

`[:SOURce] : INPut : USER : TRIGger : IMPedance` on page 651

`[:SOURce] : INPut : USER : CLOCk : IMPedance` on page 651

Clock Input Slope

Sets the polarity of the active slope of an externally applied clock signal.

Remote command:

`[:SOURce] : INPut : USER : CLOCk : SLOPe` on page 651

Trigger Input Slope

Sets the polarity of the active slope of an applied instrument trigger.

Remote command:

`[:SOURce] : INPut : USER : TRIGger : SLOPe` on page 652

10.2.6 How to Enable Signals and Perform Signal to Connector Mapping

This section introduces the general principle of connector configuration.

General Workflow

The [Figure 10-1](#) shows the main configuration stages, together with the corresponding user interface dialogs.

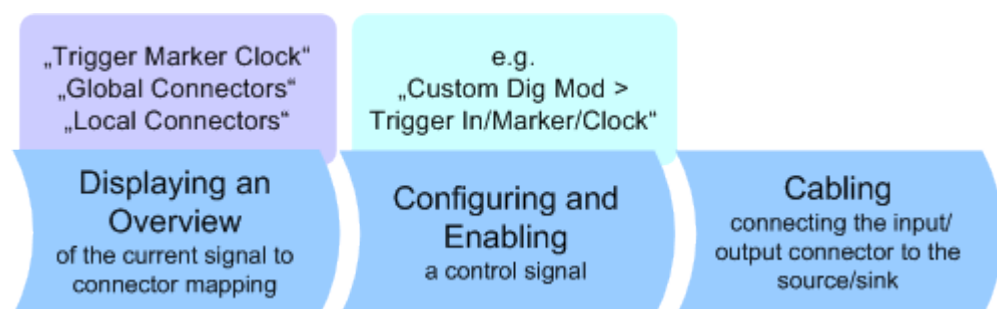

Figure 10-1: The principle of the signal to connector mapping

To perform the signal to connector mapping, perform the following:

1. Verify the current connector configuration and mapping and if necessary (re)define it.
2. Configure and enable the required signal, e.g. trigger, marker, clock signal.
3. Connect the configured connector, e.g. to the external instrument or device.

For a step-by-step description:

See [Chapter 2.3.4, "Enabling and Configuring a Marker Signal"](#), on page 60.

To find out the physical location of the connector on the front/rear panel of the instrument

Proceed as follows:

1. Select [T/M/C status LEDs](#) or [T/E/L/P/V status LEDs](#) to open the "Trigger Marker Clock" and the "RF Connectors" dialog.
2. For the corresponding connector, select the "Find" icon.

The "Find Connector" dialog opens and displays the physical location of the selected connector on the front/rear panel of the instrument.

A blinking LED on the front/rear panel indicates the selected connector, too.

See also ["Connector status indication"](#) on page 488.

10.3 Organizing Frequently Used Settings as Favorites

The [★ (User)] key is a key with customizable function. Per default, pressing the key opens the "User Menu" but you can add or remove actions, too. You can add actions to be executed or function to be accessed upon pressing this key.

User menu and [★ (User)] key

These two functions work similar to the favorites function of browser or other programs. They allow you to create a list of frequently used actions or to group frequently used settings in one single dialog.

Possible applications

The ★ (User) key is useful in the following situations:

- There are functions or tasks you have to perform in a defined order but they are distributed among several dialogs
- There are functions or tasks you have to perform more frequently than others but they are not accessible via a front panel key.
- The required functions are grouped in a dialog that is not directly accessible from the blocks on the block diagram.
- Your task involves the frequently loading and executing of certain SCPI scripts. Refer to [Chapter 11.14, "How to Record / Create SCPI Lists"](#), on page 565 for information on how to create an SCPI script.

- A quick access to saved setups is required.

Dialog identification

To identify each dialog, the instrument uses a dedicated dialog ID. The dialog ID contains the dialog position on the display and the current active tab. The action that triggers the instrument to open a dialog uses this identification.

Save/Recall vs. recall setup

Sometimes, you would like to restore a specific signal generation setup and perform further configurations based on this particular instrument state. The R&S SMBV100B provides two ways to achieve this, by the "Save/Recall" function and by the "Recall Setup" function.

- "Save/Recall"
For a detailed description, refer to [Chapter 9.4, "Saving and Recalling Instrument Settings"](#), on page 451.
- "Recall Setup"
If the "Recall Setup" is the only one user action assigned to the [★ (User)] key, pressing this key triggers the R&S SMBV100B to load *immediately* the user-defined preset file.



Recalling a user-defined preset file using the ★ (User) key is even faster than immediate recall function provided by the Save/Rcl key.

10.3.1 Using the User Menu for Fast Adjustments

By default, there is one predefined action assigned to the [★ (User)] key.



1. Press the [★ (User)] key.
The "User Menu" dialog opens.
If you execute this action for the first time, the dialog is empty.
2. Follow the instructions displayed in the "User Menu" dialog to build your own dialog with settings.
3. Alternatively, proceed as follows:
 - a) Open a dialog with settings you frequently use.
 - b) Select a parameter.

- c) Open the context menu and select "Add to User Menu".



A favorites icon ★ indicates that the parameter is used in the "User Menu".



The "User Menu" indication in the task bar confirms that "User Menu" with favorites is created.

- d) Press the [★ (User)] key.

The "User Menu" dialog shows all parameters that you have added to the list.

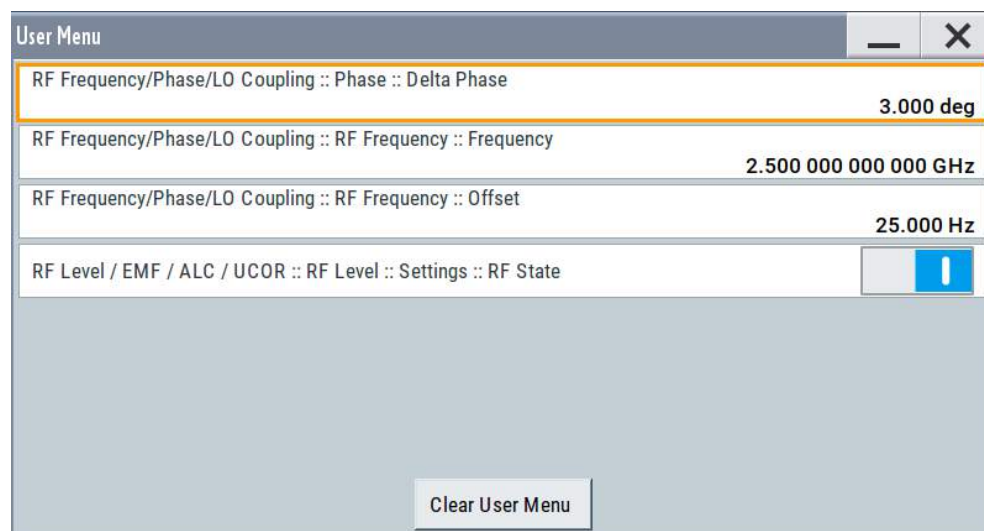

You can configure them, e.g .change state or set values, as you do in the particular dialog the entry originally appears.

4. To remove an entry, in select it (in the "User Menu" or in the particular dialog the entry originally appears).

Open the context menu and select "Remove from User Menu".



5. In the "User Menu", select "Clear User Menu" to remove all entries at once.

Settings

Clear User Menu

Removes all entries from the "User Menu" at once.

10.3.2 Define User Key Actions Settings

Access:

- ▶ Select "System Configuration > Setup > User Interface > Define User Key".

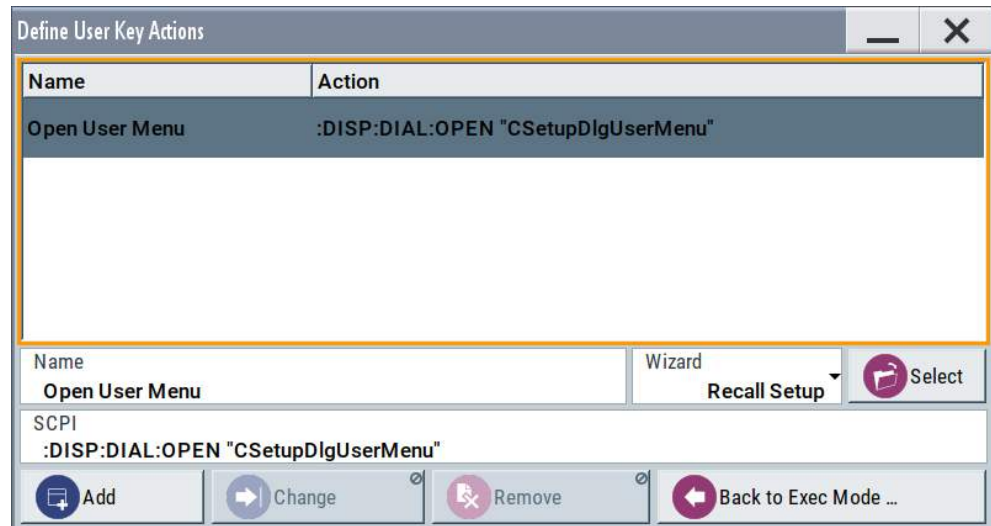

The dialog displays a list of the currently enabled actions and provides functions to define new, edit or remove existing actions. If no actions have been defined, the list is empty.

See [Chapter 10.3.3, "Assigning Actions to the \[★ \(User\)\] Key"](#), on page 500.

The remote commands required to define these settings are described in [Chapter 12.9, "DISPlay Subsystem"](#), on page 605.

Name

Enters a user-defined name for the action.

Wizard

Defines the action to be executed.

"Load SCPI Script"

Selecting the action load and executes the SCPI script.

"Recall Setup"

Load a setup for quick access to the user-defined settings.

"Open Dialog"

Quick access to the selected dialog.

Select

Depending on the selected "Wizard", provides access to:

- The standard "File Select" function for loading of an SCPI script or setup file
- A list of the dialog IDs of all currently opened dialogs. The dialog ID is used for dialog identification in the remote control.

See [SCPI](#).

SCPI

For the currently selected action, displays the corresponding SCPI command with the associated parameter for dialog identification (dialog ID). The automatically displayed SCPIs are enabled for subsequent modification.

Remote command:

:DISPlay:DIALog:OPEN on page 609

See also :DISPlay:DIALog:ID? on page 608

Add, Change, Remove

Standard functions for managing of the actions.

Back to Execute Mode

Opens the "Select Action to Execute" dialog. Select an Action form the list to execute it.

To return to the "Define User Key Actions" dialogs, select [Select Action to Execute > Define Actions](#).

Select Action to Execute > Define Actions

Name	Action
Open User Menu	:DISP:DIAL:OPEN "CSetupDlgUserMenu"
Open	:DISP:DIAL:OPEN "CSetupFrontPanelKe..."

Define Actions ...

Accesses the "Define User Key Actions" dialog.

10.3.3 Assigning Actions to the [★ (User)] Key

1. Open the dialog for that you are creating a quick access.
For example, select "Baseband > EUTRA/LTE > DL Frame Configuration > Time Plan > Detach Time Plan".
2. Select "System Configuration > Setup > User Interface > Define User Key".
3. To create an action:
 - a) Specify the "Name".
E.g. *LTE_ShowTimePlanDL*.
 - b) Select "Wizard > Open Dialog"
 - c) Select "Select" and select the dialog ID from the list

The corresponding SCPI command is automatically displayed and can be later modified.

4. Select "Add" to store the new action in the list of user key actions.

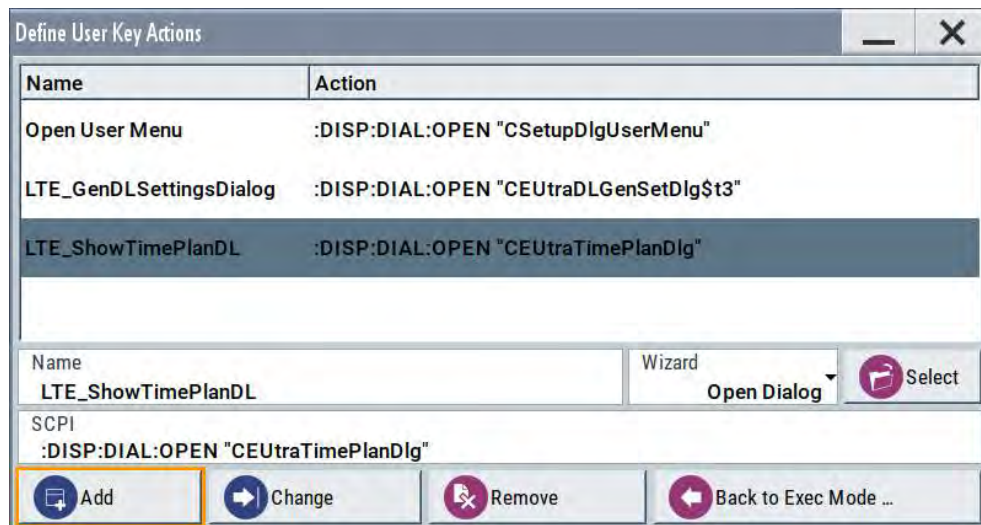

5. To execute the created action, press ★ (User).
 In the list of actions ("Select Action to Execute" dialog), navigate to the required action.
 In this example, this is "LTE_ShowTimePlanDL".

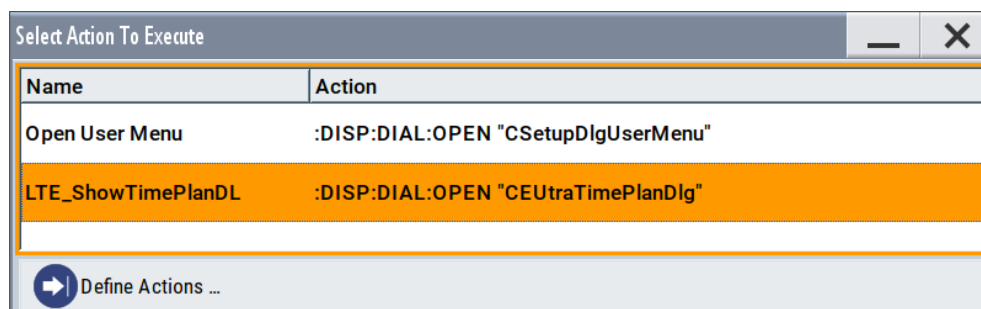

The action is executed. The dialog opens.

10.4 Managing Licenses and License Keys

An option is ready to operate after it is enabled with a license keycode supplied with the option. The license key is delivered as a file or on paper. Unregistered licenses must be registered for a particular instrument before the corresponding option can be enabled for operation.



For reliable operation, a software option usually requires the latest firmware version. The required version is specified in the delivery. If your instrument works with a former firmware version, update the firmware before enabling the software option. The firmware update is described in the R&S SMBV100B service manual.

10.4.1 Manage License Keys Settings

This dialog is the central dialog for licenses registration and performing the required instrument-related steps during the process of unregistration.

Access:

1. Select "System Config > Setup > Instrument Assembly > Manage License Keys > New License".

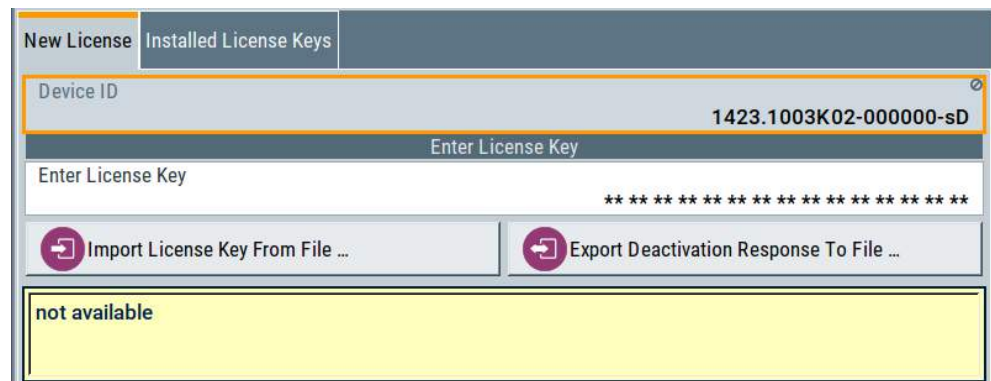

2. Select "System Config > Setup > Instrument Assembly > Manage License Keys > Installed License Keys".



In this dialog, you can activate licenses for newly purchased and/or newly registered options, perform the necessary steps to cancel a registration and/or to move licenses.

Settings

- Device ID.....503
- Enter License Key.....503
- Import License Key from File.....503
- Export Deactivation Response to File.....503
- Info Line.....503
- Installed License Keys.....503
 - └ Show Inactive.....503
 - └ Show Deactivated.....503
 - └ Installed License Keys Table.....503

Device ID

Displays the instrument-specific identification number. The device ID is a unique string with the following structure:

```
<stock number>-<serial number>-<checksum>
```

Enter License Key

Type here the license key provided with the option.

For license keys delivered as a file, use [Import License Key from File...](#)

Import License Key from File...

Opens a dialog for selecting the file with the license key.

Use this function also to import the deactivation key file generated by the R&S License Manager online tool (see [How to Move a Portable License](#)).

Export Deactivation Response to File...

Exports the generated deactivation response key to a file and opens a file management dialog to save the file.

This key is required during the unregistration process, e.g. when you want to uninstall an option or have a portable option, which you want to register later on another instrument (see [How to Move a Portable License](#)).

Info Line

Indicates status information on the performed actions.

Installed License Keys

Access: select "System Config > Setup > Instrument Assembly > Manage License Keys > Installed License Keys".

Comprises information on the installed options.

Show Inactive ← Installed License Keys

Enables/disables the display of the inactive (expired) licenses in the [Installed License Keys Table](#).

Show Deactivated ← Installed License Keys

Enables/disables the display of the deactivated licenses in the [Installed License Keys Table](#).

See [How to Move a Portable License](#) for information on how to activate deactivated licenses.

Installed License Keys Table ← Installed License Keys

Shows information on the currently installed options.

"Export License Key to File"

Opens a dialog to save the generated license key file. This file is required during the unregistration process.

If you have a portable unregistered option, you can register it later on another instrument (see [How to Move a Portable License](#)).

"Option"	Displays the option short designation. Tip: Open the Hardware Options/Software Options dialog to retrieve more information about the installed options.
"License Count"	Displays the number of the licenses for the selected option key.
"License Type"	Displays the type of license. A license type determines the common qualification application duration and the portability of a license. The following license types are provided: evaluation, permanent, portable, quantified, time-controlled with a duration of 1, 3, 6 or 12 months. A license can also be deactivated or expired. For time limited licenses, the left time of applicability is displayed too.
"Registration"	(reserved for future use)

10.4.2 How to Move a Portable License

This example is intended to explain how to perform the required steps at the instrument.

Use a USB flash drive to transfer the license key files between the instruments and the browser.



We assume knowledge about the handling of the R&S License Manager online tool and the description of the whole process.

1. Open your browser. Enter <https://extranet.rohde-schwarz.com/service>.
Select "Manage Licenses > Move Portable License".
The first step requires the Device IDs of the source and target instruments.
2. To find out the Device IDs, proceed as follows:
 - a) On the source instrument, select "System Config > Setup > Instrument Assembly > Manage License Keys > New License > Device ID".
 - b) On the target instrument, select "System Config > Setup > Instrument Assembly > Manage License Keys > New License > Device ID".
 - c) In the browser, select "Manage Licenses > Move Portable License > Select Devices" and enter the Device IDs.
3. On the source instrument, select "System Config > Setup > Instrument Assembly > Manage License Keys > Installed License Keys > License Keys Table".
Navigate to the portable license you want to move.
Select the "Export License to File" column.
A standard file manager dialog opens.
4. Enter a filename. Save the exported license key, e.g.
`k123_portable_key_to_move.xml`.

5. In the browser, select "Manage Licenses > Move Portable License > Select License (from file)" and select the exported license key.
Check the selection. Create the deactivation key. Save it to file.
6. On the source instrument, select "System Config > Setup > Instrument Assembly > Manage License Keys > New Licences > Import License Keys from File".
Select the transferred deactivation key.
7. On the source instrument, select "System Config > Setup > Instrument Assembly > Manage License Keys > New Licences > Export Deactivation Response to File".
8. In the browser, go to "Manage Licenses > Move Portable License > Install Deactivation Key (from file)".
Enter the deactivation response of the instrument.
The license is deactivated for the source instrument.
9. In the "Manage Licenses > Move Portable License", go to step "Create License" to generate a license key for this portable option and the selected target instrument.
Download the license key as a file. Transfer it to the target instrument.
10. In the target instrument, select "System Config > Setup > Instrument Assembly > Manage License Keys > New License > Import License Keys from File".
Select the created license key file.

The portable option is installed on the target instrument.

10.5 Using the Security Settings

The protection function of the R&S SMBV100B offers several levels to activate particular functions like self-test or tests for service purposes specifically.

Protection

The five protection levels are automatically active on startup, the protection levels, that means all protected functions are locked.

To unlock a protection level:

- ▶ In the "System Config > Setup > Security > Protection", enter the correct password.

To lock a protection level:

- ▶ Clear the corresponding checkbox.

Protection levels

The following functions are protected in the respective levels:

- Protection level 1
Protects against accidental changes, like, for example, the clock and date, several internal adjustments functions and the self-test, as well as network settings or the instrument hostname.

You can access this level with the password 123456.

- Protection level 2
Unlocks protected service functions. It is accessible to authorized personnel of Rohde & Schwarz service department only.
- Protection level 3 to 5
Are reserved for factory internal use.

Security

The security concept of the R&S SMBV100B helps you to protect your instrument against uncontrolled access and changes. All provided security services require that you enter the security password.

Provided security services are:

- **General** security parameters, such as:
 - **USB storage** that secures controlled access to the mass memory of the instrument
 - **Volatile mode** that prevents information to be written to the internal memory permanently.
 - **Sanitizing** that prevents the instrument from leaving a secure environment with stored user information.
 - **Annotation** frequency and amplitude prevent reading the display.
 - **Secure Update Policy** check that verifies the integrity and origin of the firmware package to be installed.
To access the settings of these topics, see [Setting Security Parameters > "Secure Update Policy"](#) on page 508.
- **Password** management secures controlled user access to the instrument
With the two-step password concept, you can assign a user-defined password for the operating system, and a security password for accessing the mass storage of the instrument.
See also [Chapter 10.5.4, "Password Management"](#), on page 515.
- **LAN services** secure controlled network access
You can individually lock and unlock the supported LAN interface services, see [Chapter 10.5.3, "Configuring LAN Services"](#), on page 513.
Remote control via LAN interface requires that the interface is activated, but you can enable the required services specifically.
- **User interface** prevents front panel operation and/or reading the display.

For more information, see the document R&S SMBV100B Instrument Security Procedures.

10.5.1 Protection Level Settings

Access:

- ▶ Select "System Config > Setup > Security > Protection".

Protection Level 1	<input checked="" type="checkbox"/>	Password	*****
Protection Level 2	<input checked="" type="checkbox"/>	Password	*****
Protection Level 3	<input checked="" type="checkbox"/>	Password	*****
Protection Level 4	<input checked="" type="checkbox"/>	Password	*****
Protection Level 5	<input checked="" type="checkbox"/>	Password	*****

The "Protection" dialog provides access to the unlocking of different protection levels.

Several functions in the instrument are password-protected to prevent for example accidental changes, "Protection" on page 505.

The remote commands required to unlock a protected stage are described in [Chapter 12.17, "SYSTem Subsystem"](#), on page 882.

Protection Level/Password

Unlocks the selected level of protection, if you enter the correct password.

The default protection level 1 password is 123456.

To lock the protection level again, clear the checkbox.

Remote command:

`:SYSTem:PROTECT<ch>[:STATe]` on page 890

10.5.2 Setting Security Parameters

Access:

- ▶ Select "System Config > Setup > Security > Security > General".

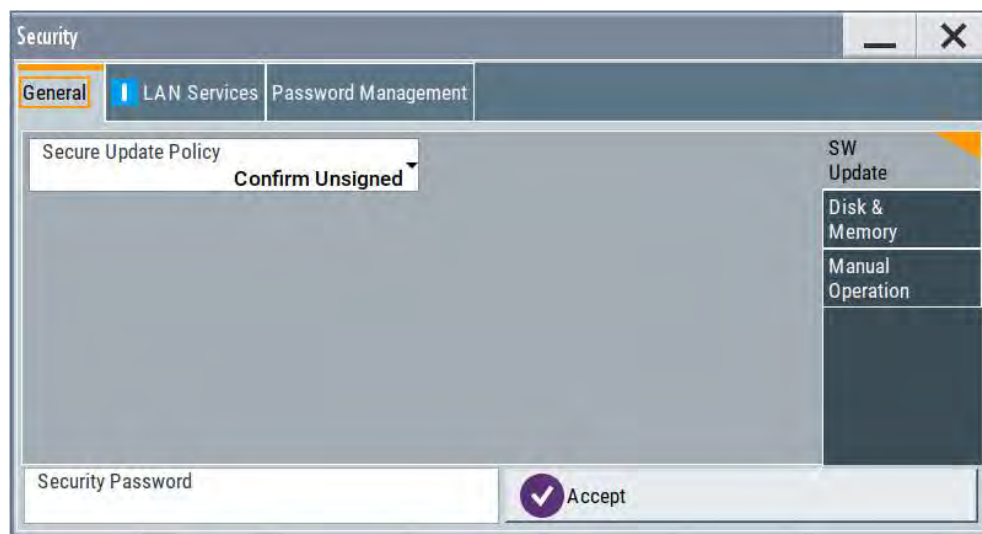

In the "General" tab, you can determine the security level for firmware updates, and configure the security settings for the mass memory and manual operation.



All modified settings in this dialog are not applied until you enter the [Security Password](#) and confirm with [Accept](#).

10.5.2.1 Update Policy Security Settings

Access:

- ▶ Select "System Config > Setup > Security > Security > General > SW Update".



The SW Update tab enables you to select the security mode for firmware updates.

The remote commands available to control security settings are described in [Chapter 12.17, "SYSTEM Subsystem"](#), on page 882.

Secure Update Policy

Allows you to configure the automatic signature verification for firmware installation.

To apply the change: enter the security password and confirm with "Accept". Otherwise the change has no effect.

See also:

- [Chapter 10.5, "Using the Security Settings"](#), on page 505 for more information on the security concept.
- The release notes for details on signature verification when installing new or former firmware versions, available at www.rohde-schwarz.com/firmware/smbv100b.

"Confirm Unsigned"

Performs the signature verification.

If the check detects any discrepancies, the instrument issues a warning message. You can still update the firmware or reject updating.

This setting also enables you to downgrade the firmware version.

"All Packages" Accepts all packages without signature verification.

"R&S Signed Packages"

Performs the signature check.

If the check detects any discrepancies, the instrument issues a warning message and locks the update to this firmware.

Remote command:

:SYSTem:SECurity:SUPolicy on page 899

10.5.2.2 Disk & Memory Security Settings

Access:

- ▶ Select "System Config > Setup > Security > Security > General > Disk & Memory".



The "Disk & Memory" tab secures controlled access to the mass memory and prevents information from leaving a secure environment.

The remote commands available to control security settings are described in [Chapter 12.17, "SYSTem Subsystem"](#), on page 882.

USB Storage

Activates the access to external USB storage media.

To apply the change: enter the security password and confirm with "Accept". Otherwise the change has no effect.

See also [Chapter 9.9.4, "Using a USB Storage Device for File Transfer"](#), on page 473.

**Volatile Mode**

Activates volatile mode, so that no user data can be written on the internal memory permanently.

In volatile mode:

- Data that the instrument normally stores on the internal memory is redirected to volatile memory.
- The user directory is mapped to the volatile memory. You access the temporary data just as data stored in the `/var/user/`, see [Chapter 9.3, "Protecting Data"](#), on page 451.
- Data on the internal memory cannot be changed. It is protected against modification or erasure.
- You can only save data:
 - Temporarily in the volatile memory
 - On a connected external storage device, such as a memory stick

To activate volatile mode: enter the security password, confirm with "Accept" and reboot the instrument. Otherwise the change has no effect.

Activated volatile mode is indicated by an icon.

Remote command:

`:SYSTEM:SECURITY:VOLMode[:STATe]` on page 890

Sanitize

Executes the erase procedure that sanitizes the internal memory.

If the instrument is subject to high security, and you have not enabled the volatile mode, the internal flash memory holds user-data, i.e. it poses a security risk. The sanitizing function makes sure that no user information is stored on the instrument when it leaves the secure environment.

To apply the change: enter the security password and confirm with "Accept". Otherwise the change has no effect.

See also [Chapter 10.5, "Using the Security Settings"](#), on page 505 for more information on the security concept.

Remote command:

`:SYSTEM:SECURITY:SANitize[:STATe]` on page 898

10.5.2.3 Manual Operation Security Settings

Access:

- ▶ Select "System Config > Setup > Security > Security > General > Manual Operation".

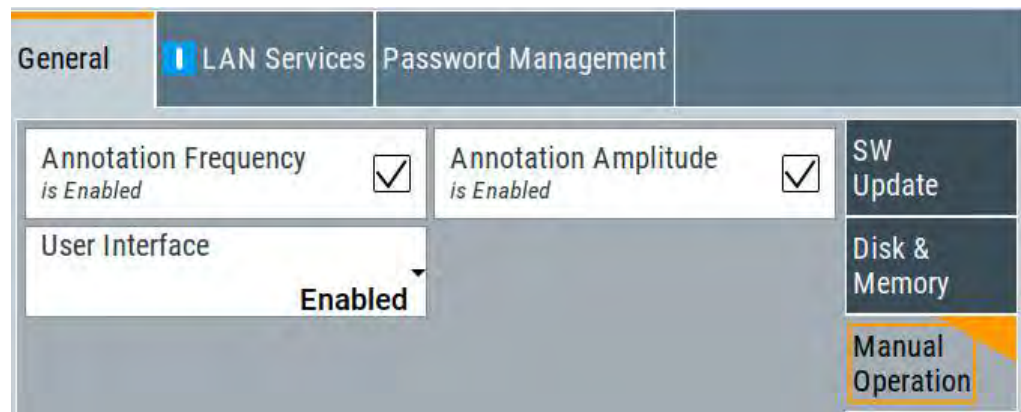

The "SW Update" tab enables you to lock front panel operation and/or reading the display.

The remote commands available to control security settings are described in [Chapter 12.9, "DISPlay Subsystem"](#), on page 605, and the [Chapter 12.17, "SYSTEM Sub-system"](#), on page 882.

Annotation Frequency

Enables the display of the currently used frequency in the status bar.

To apply the change: enter the security password and confirm with "Accept". Otherwise the change has no effect.

Remote command:

`:DISPlay:ANNotation:FREQuency` on page 608

Annotation Amplitude

Enables the display of the currently selected level in the status bar.

To apply the change: enter the security password and confirm with "Accept". Otherwise the change has no effect.

Remote command:

`:DISPlay:ANNotation:AMPLitude` on page 607

User Interface

Allows you to lock the controls for manual operation and the display individually.

To apply the change: enter the security password and confirm with "Accept". Otherwise the change has no effect.

See also [Chapter 10.5, "Using the Security Settings"](#), on page 505 for more information on the security concept.

"Enabled" Enables the display and all controls for the manual operation of the instrument.

"Touchscreen Off"

Locks the touch sensitivity of the screen.

This security feature protects the instrument against unintentional change of settings by accidentally touching of the screen.

Still available controls for manual operation are:

- The keys at the front panel, including the rotary knob
- The external mouse and keyboard
- Remote operation over VNC

The instrument indicates the locked touchscreen by an icon .

Unlocking is possible via VNC, external controls or remote control.

"VNC Only"

Locks the keys at the front panel, the touchscreen and externally connected keyboard and mouse.

The display on the screen remains and shows the current settings and changes.

The instrument indicates the activated "VNC only" feature by the icon .

Unlocking is possible via VNC or turning off and on again.

"Display Only"

Locks the manual operation of the instrument. The display on the screen remains and shows the current settings and changes.

This security feature protects the instrument against unauthorized access, but still shows the current settings and processes, for example when you operate the instrument via remote control.

The function disables:

- The touchscreen functionality of the display
- The keys at the front panel of the instrument
- The external mouse and keyboard

The instrument indicates the locked controls by a padlock  softkey.

Unlocking is possible by entering the security password, see [Enabling a locked user interface for manual operation](#).

"Disabled"

Locks the display and all controls for the manual operation of the instrument.

This security feature protects the instrument against unauthorized reading and access, for example when you operate the instrument via remote control.

The function disables:

- The display
- The touchscreen
- The keys at the front panel of the instrument
- The external mouse and keyboard

The screen shuts off and displays a padlock symbol  instead.

Unlocking is possible by entering the security password, see also [Enabling a locked user interface for manual operation](#).

Remote command:

:SYSTem:ULOCK on page 888

:SYSTem:DLOCK on page 889

:SYSTem:KLOCK on page 889

Enabling a locked user interface for manual operation

To unlock the user interface for manual operation, use one of the following:

- On the instrument's keypad or external keyboard, press any key.
The instrument prompts you to enter the security password for unlocking.



Note: The character of the first key you pressed is immediately added in the input field. Delete the entry before inserting the password.

Enter the security password `123456`.

- In remote control mode, send the command `SYST:ULOC ENABled` to release all locks at once.

Alternatively:

- Send the command `SYST:KLOC OFF` to unlock the keyboard and touchscreen
- Send the command `SYST:DLOC OFF` to release all locks.

Via remote control, there is no password required.

Remote command:

[:SYSTem:ULOCK](#) on page 888

[:SYSTem:DLOCK](#) on page 889

[:SYSTem:KLOCK](#) on page 889

10.5.3 Configuring LAN Services

Access:

- ▶ Select "System Config > Setup > Security > Security > LAN Services".

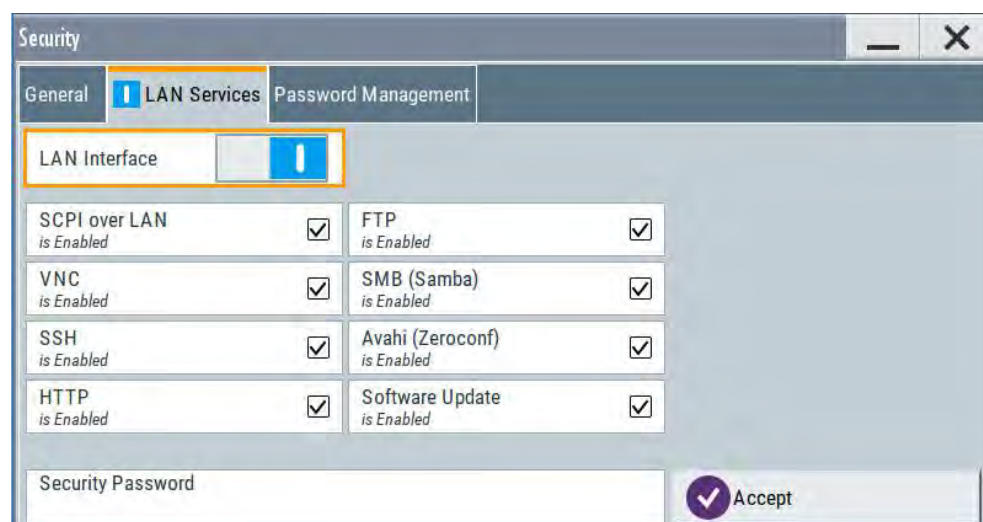

In the "LAN Services" dialog, you can individually enable or disable the supported LAN interface services.



The activated LAN services are not activated until you enter the "Security Password" on page 514 and confirm with [Accept](#).

LAN

Enables the LAN interface in general, and thus provides remote access via all unlocked services.

Enable LAN Services individually

Enables or disables the following interface services individually.

"SCPI over LAN"

Activates access over LAN to control the instrument remotely, by using SCPI (Standard Commands for Programmable Instruments) commands.

See also ["Starting a remote control session over LAN with R&S VISA"](#) on page 553.

"VNC"

Activates access via VNC (Virtual Network Computing) interface, a graphical desktop sharing system that uses RFB protocol to control the instrument remotely.

See also [Chapter 11.16, "How to Set Up Remote Operation via VNC"](#), on page 569.

"SSH"

Activates access via SSH (Secure Shell), a network protocol for secure data communication.

"HTTP"

Activates access via HTTP (Hyper Text Transfer Protocol), the application protocol for hypermedia information systems.

"FTP"

Activates access via FTP (File Transfer Protocol), used to transfer files from a host to the instrument and vice versa.

See also [Chapter 9.9.2, "Accessing the File System of the R&S SMBV100B Via ftp"](#), on page 470.

"SMB (Samba)"

Activates access to SMB (Server Message Block), used for providing shared access to files, printers and serial ports of a network.

See also [Chapter 9.9.3, "Accessing the R&S SMBV100B File System Via SMB \(Samba\)"](#), on page 471.

"Avahi (Zeroconf)"

Activates Avahi, a service for automatic configuration of the instrument in a network environment.

"Software Update"

Allows updating the software.

Security Password

Enters the password that is required to enable or to disable the settings protected by a security password. Default is 123456.

Note:

- We recommend that you change the default security password before connecting the instrument to the network.
- The security settings are not assigned until you select the "Accept" button.

Accept

Applies the modified settings, provided the security password is entered and correct.

10.5.4 Password Management

Access:

1. Select "System Config > Setup > Security > Security > Password Management > User Password".

The screenshot shows a web-based configuration interface. At the top, there are three tabs: 'General', 'LAN Services', and 'Password Management'. The 'Password Management' tab is selected. Below the tabs, the main content area is titled 'Valid for VNC, FTP and SMB (Samba) access'. This area contains three text input fields: 'User Name' (containing 'instrument'), 'Old Password', and 'New Password'. Below these is a 'Confirm Password' field. At the bottom of this section is a 'Change Password' button with a wrench icon. To the right of the main form area, there is a vertical sidebar with two sections: 'User Password' and 'Security Password'.

In this tab, you can assign the security and a user-defined password.

2. Select "System Config > Setup > Security > Security > Password Management > Security Password".



A new password does not take effect until you confirm it with the corresponding "Change Password" button.

To confirm the new password, always press:

- "User Password" > [Change Password](#)
- Or
- "Security Password" > [Change Password](#)

User Name

Indicates the user name used for access to the Linux operating system and valid for VNC, FTP and SMB (Samba) access.

User Password

Access: select "System Config > Setup > Security > Security > Password Management > User Password".

Allows you to change and confirm the user password.

Old Password ← User Password

Enters the current user password. The default password is "instrument".

Note: We recommend that you change the default password before connecting the instrument to a network.

New Password ← User Password

Enters the new user password.

The security password can contain decimal characters only.

Confirm Password ← User Password

Confirms the new user password by repeating.

Note: The new password is not assigned until you select the [Change Password](#) button.

Change Password ← User Password

Changes the user password accordingly.

Security Password

Access: select "System Config > Setup > Security > Security > Password Management > Security Password".

Enables you to change and confirm the security password.

Old Password ← Security Password

Enters the currently used security password. The default password is '123456'.

Note: We recommend that you change the default password before connecting the instrument to a network.

The security password is required when changing the status of the USB and LAN interface.

New Password ← Security Password

Enters the new security password.

The security password can contain decimal characters only.

Confirm Password ← Security Password

Confirms the new security password by repeating.

Note: The new password is not assigned until you select [Change Password](#) button.

Change Password ← Security Password

Changes the password accordingly.

10.6 Undoing or Restoring Actions

"Undo" is a function that removes the effect of the last action on the instrument and reverts it to an older state. Conversely, "Redo" restores a previously undone action.

You can "Undo/Redo" actions according to two criteria:

- Step by step
Gradually undo/redo the actions in reverse order as previously performed. Depending on the available memory the "Undo/Redo" steps may restore all actions.
- Multiple steps at once
Select any specific action in the history list to "Undo/Redo" multiple actions in a single step.
Note: This mode requires a system restoration file on the instrument.

Access:

- ▶ Select "Setup > Settings > Undo/Redo".

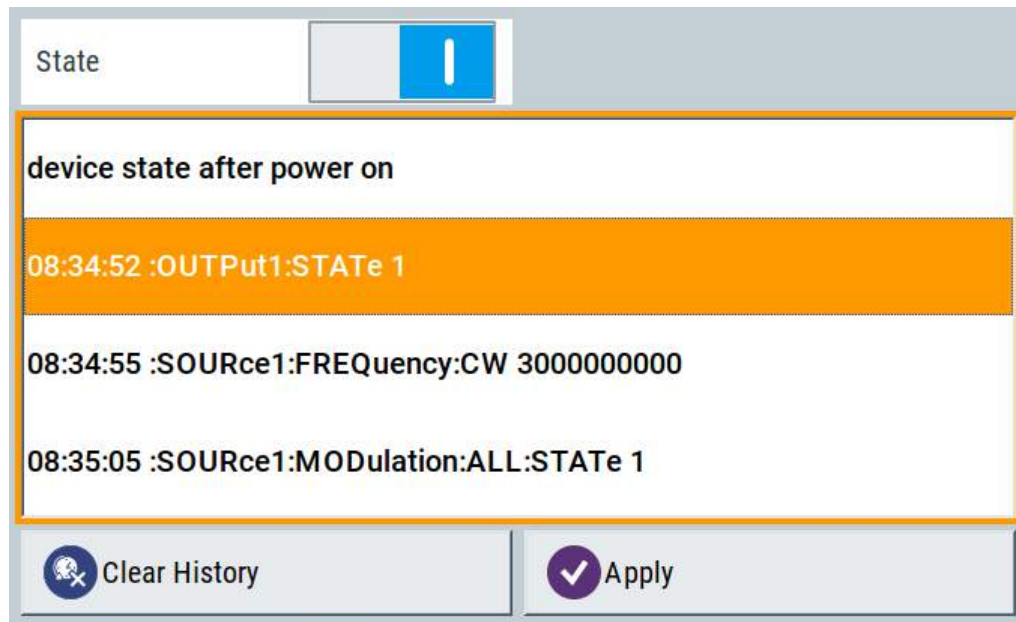

The dialog contains all functions for enabling the "Undo/Redo" functionality.

Settings:

State.....	518
History List.....	518
Clear History.....	518
Apply.....	518

State

Enables the recording of the performed actions.

History List

Lists the performed actions, provided "Undo/Redo" state is "On".

Clear History

Deletes the recorded list of the performed steps.

Apply

Performs the "Undo/Redo".

If you select a previously performed action of the list, all subsequent actions are undone. The list entries remain.

If you select a subsequently executed action, you can restore all the actions undone up to this state.

10.7 Shutting Down and Rebooting the Instrument

The On/Standby front panel key switches the instrument from the standby to the ready state or vice versa. In remote operation from a remote computer or in manual control, there is another possibility to shut down the instrument or to reboot the system.

Access:

- ▶ Select "System Config > Setup > Maintenance > Shut down".

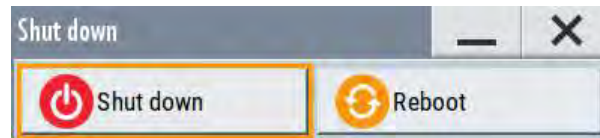

Remote control commands:

- `:SYSTem:REBoot` on page 905
- `:SYSTem:SHUTdown` on page 906

11 Network Operation and Remote Control



The description in this section requires basic knowledge of the remote control operation. Definitions specified in the SCPI standard are not provided.

You find some basic information to the SCPI syntax, command lists, and general programming recommendations in [Chapter A.1, "Additional Basics on Remote Control"](#), on page 946. See also [Chapter A.1.5, "Status Reporting System"](#), on page 958 for information on the status reporting system of the instrument.

As an alternative to the interactive operation directly at the instrument, you can operate the R&S SMBV100B also from a remote location.

The [Figure 11-1](#) shows the possibilities of the physical connection (interfaces) for the remote access.

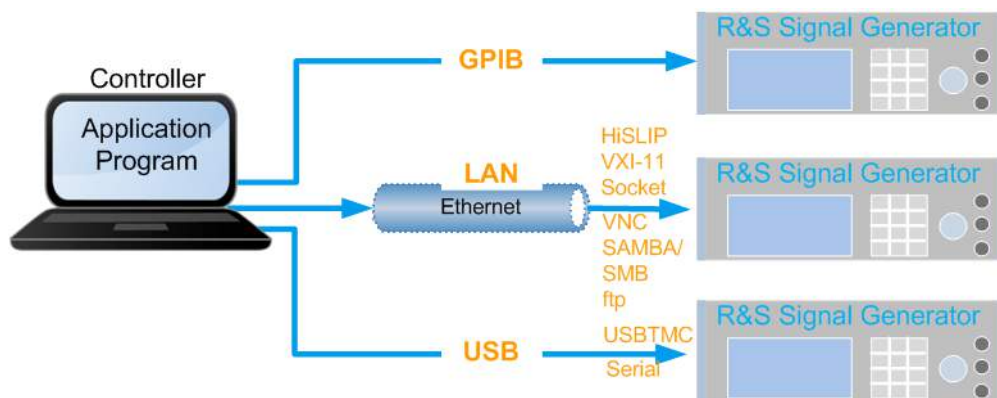

Figure 11-1: Supported remote connections



For information on how to configure a network, see the [Chapter 2.1.4, "Setting Up a Network \(LAN\) Connection"](#), on page 37.

The various interfaces provide flexible access to the instrument, such as *remote control*, *remote operation* or *remote file access*. These remote access modes are fundamentally different, although they are often considered interchangeable. Refer to [Overview of Remote Access Modes](#) for details on these modes.

For comprehensive information on these topics, refer to the application note [1GP72: Connectivity of Rohde&Schwarz Signal Generators](#).

11.1 Overview of Remote Access Modes

This section outlines the possible access modes and their major characteristics.

Remote control (SCPI)

- A remote PC controls the instrument, usually via VISA (Virtual Instrument Software Architecture) interfaces.
- Remote control disables the manual operation of the instrument; you can set different lock states.
- The GUI is not visible.
- Remote control commands (SCPI) perform the settings, either individually or in sequences (SCPI programs).
- Using SCPI programs is faster than the manual operation, since they automate repeating applications.

Remote operation (VNC)**NOTICE****Risk of unauthorized access**

If the VNC service is enabled on the instrument, any user in the network who knows the computer name and password can access it.

Disable the VNC service on the instrument to prevent unauthorized access.

- A remote device accesses the instrument via the common platform technology VNC (Virtual Network Computing).
- The protocol allows simultaneous operation from several remote devices and the instrument nevertheless remains locally operable.
- The GUI is visible.
- To perform the settings, you can operate the instrument as with the manual control.
- Clients supporting remote operation depend on the used remote device, see [Table 11-1](#).

Table 11-1: Supported VNC operation modes

Remote device	VNC client	Requirements	Characteristics
Desktop (Windows, Linux, Mac™OS)	<ul style="list-style-type: none"> • Ultr@VNC • Other dedicated client software 	<i>Ultr@VNC or Client Software</i> must be installed.	Fast, supports several options like full screen mode or auto-login.
	<ul style="list-style-type: none"> • Any web browser 	<i>Java Runtime</i> must be installed and activated in the browser settings.	Fast and convenient - only the instrument address required. Java runtime is sometimes considered as security concern.
	<ul style="list-style-type: none"> • Web browser with HTML5 	<i>Web sockets</i> must be supported.	Slower than the other modes. No additional installation or activation required. No security concern.

Remote device	VNC client	Requirements	Characteristics
Smart device (Tablet/ smartphone)	<ul style="list-style-type: none"> Dedicated client App 	<i>App</i> must be installed.	Fast, supports several options like full screen mode or auto-login.
	<ul style="list-style-type: none"> Web browser with HTML5 	<i>Web sockets</i> must be supported.	Support of QR code scanning Slower than a dedicated App.

Remote file access (FTP, SAMBA/SMB)

- A remote client accesses the instrument's file system, using the protocols FTP (file transfer protocol) and SAMBA/SMB (server message block).
- The protocols enable you to transfer files from or to the instrument and to get direct access to its file sharing directory *share*.

For more information, refer to [Chapter 9.9, "How to Transfer Files from and to the Instrument"](#), on page 468.

11.2 Remote Control Interfaces and Protocols

The instrument supports various interfaces for remote control. The table gives an overview on the connectivity:

Table 11-2: Remote control interfaces and protocols

Interface	Protocols, VISA ^{*)} address string and library	Remarks
Local area network (LAN)	<ul style="list-style-type: none"> HiSLIP High-Speed LAN Instrument Protocol (IVI-6.1) TCPIP::host address::hislip0[::INSTR] VISA VXI-11 TCPIP::host address[:: LAN device name][::INSTR] VISA Socket communication (Raw Ethernet, simple Telnet) TCPIP::host address[:: LAN device name]::<port>::SOCKET VISA or socket controller 	<p>The LAN connector is on the rear panel of the instrument.</p> <p>The interface is based on TCP/IP and supports various protocols.</p> <p>For a description of the protocols, refer to:</p> <ul style="list-style-type: none"> Chapter 11.2.1.2, "HiSLIP Protocol", on page 525 Chapter 11.2.1.3, "VXI-11 Protocol", on page 525 Chapter 11.2.1.4, "Socket Communication", on page 525
USB	<ul style="list-style-type: none"> USBTMC USB::<vendor ID>::<product ID>:: <serial number>[::INSTR] VISA 	<p>The USB In connector is located at the rear panel of the instrument.</p> <p>For a description of the interface, refer to Chapter 11.2.2, "USB Interface", on page 526</p>
GPIB (IEC/IEEE Bus Interface)	<ul style="list-style-type: none"> – GPIB::<address>[::INSTR] (no secondary address) VISA 	<p>Optional GPIB bus interfaces according to standard IEC 625.1/IEEE 488.1 are located on the rear panel of the instrument.</p> <p>For a description of the interface, refer to Chapter 11.2.3, "GPIB Interface (IEC/IEEE Bus Interface)", on page 527.</p>

^{*)} VISA (Virtual Instrument Software Architecture) is a standardized software interface library providing input and output functions to communicate with instruments. A VISA installation on the controller is a prerequisite for remote control over LAN (when using VXI-11 or HiSLIP protocol), USB and serial interface. For remote control via socket communication VISA installation is optional. For more information, see [Chapter 11.3.1, "VISA Library"](#), on page 528.



Rohde & Schwarz provides the standardized I/O software library R&S VISA for communication with the instruments via TCP/IP (LAN: HiSLIP, VXI-11 and raw socket) or USB (USBTCM) interfaces.

R&S VISA is available for download at the Rohde & Schwarz website <http://www.rohde-schwarz.com/rsvisa>.

How to configure the remote control interfaces is described in [Chapter 11.8, "How to Set Up a Remote Control Connection"](#), on page 548.

SCPI (Standard Commands for Programmable Instruments)

SCPI commands - messages - are used for remote control. Commands that are not taken from the SCPI standard follow the SCPI syntax rules. The instrument supports the SCPI version 1999. The SCPI standard is based on standard IEEE 488.2 and aims at the standardization of device-specific commands, error handling and the status registers. The tutorial "Automatic Measurement Control - A tutorial on SCPI and IEEE 488.2" from John M. Pieper (Rohde & Schwarz order number 0002.3536.00) offers detailed information on concepts and definitions of SCPI.

Tables provide a fast overview of the bit assignment in the status registers. The tables are supplemented by a comprehensive description of the status registers.

For more information, see also [Chapter A.1, "Additional Basics on Remote Control"](#), on page 946.

11.2.1 LAN Interface

To be integrated in a LAN, the instrument is equipped with a LAN interface, consisting of a connector, a network interface card and protocols.

For remote control via a network, the PC and the instrument must be connected via the LAN interface to a common network with TCP/IP network protocol. The TCP/IP network protocol and the associated network services are preconfigured on the instrument. Software for instrument control and (for specified protocols only) the VISA program library must be installed on the controller.



Identifying instruments in a network

If several instruments are connected to the network, each instrument has its own IP address and associated resource string. The controller identifies these instruments by the resource string.

11.2.1.1 VISA Resource Strings

The VISA resource string is required to establish a communication session between the controller and the instrument in a LAN. The resource string is a unique identifier, composed of the specific IP address of the instrument and some network and VISA-specific keywords.

TCPIP::host address[:LAN device name][:INSTR]

TCPIP = designates the network protocol
 host address = designates the IP address or hostname of the instrument
 [:LAN device name] = defines the protocol and the instance number of a subinstrument
 [:INSTR] = indicates the instrument resource class (optional)

The **IP address** (host address/computer name) is used by the programs to identify and control the instrument. It is automatically assigned by the DHCP server the first time the device is registered on the network. Alternatively, you can also assign its **LAN device name**.

If assigned, the IP address is displayed on block diagram. You can adjust it manually with the parameter the "System Config > Remote Access > Network" > [IP AddressEnabling a locked user interface for manual operation](#).

The following section lists the characteristics of the VISA resource strings for the corresponding interface protocols. The highlighted characters are crucial.

HiSLIP

TCPIP::host address::hislip0[:INSTR]

hislip0 = HiSLIP device name, designates that the interface protocol HiSLIP is used (mandatory)

hislip0 is composed of [:HiSLIP device name [, HiSLIP port]] and must be assigned.

For details of the HiSLIP protocol, refer to [Chapter 11.2.1.2, "HiSLIP Protocol"](#), on page 525.

VXI-11

TCPIP::host address[:inst0][:INSTR]

[:inst0] = LAN device name, indicates that the VXI-11 protocol is used (optional)

inst0 currently selects the VXI-11 protocol by default and can be omitted.

For details of the VXI-11 protocol, refer to [Chapter 11.2.1.2, "HiSLIP Protocol"](#), on page 525.

Socket communication

TCPIP::host address::port::SOCKET

port = determines the used port number
 SOCKET = indicates the raw network socket resource class

Socket communication requires the specification of the port (commonly referred to as port number) and of "SOCKET" to complete the VISA resource string with the associated protocol used.

The registered port for socket communication is port 5025.

See also [Chapter 11.2.1.4, "Socket Communication"](#), on page 525.

11.2.1.2 HiSLIP Protocol

The HiSLIP (**H**igh **S**peed **L**AN **I**nstrument **P**rotocol) is the successor protocol for VXI-11 for TCP-based instruments specified by the IVI foundation. The protocol uses two TCP sockets for a single connection - one for fast data transfer, the other for non-sequential control commands (e.g. `Device Clear` or `SRQ`).

HiSLIP has the following characteristics:

- High performance as with raw socket network connections
- Compatible IEEE 488.2 support for Message Exchange Protocol, Device Clear, Serial Poll, Remote/Local, Trigger, and Service Request
- Uses a single IANA registered port (4880), which simplifies the configuration of firewalls
- Supports simultaneous access of multiple users by providing versatile locking mechanisms
- Usable for IPv6 or IPv4 networks



Using VXI-11, each operation is blocked until a VXI-11 device handshake returns. However, using HiSLIP, data is sent to the device using the "fire and forget" method with immediate return. Thus, a successful return of a VISA operation such as `viWrite()` does not guarantee that the instrument has finished or started the requested command, but is delivered to the TCP/IP buffers.

For more information see also the application note:

[1MA208: Fast Remote Instrument Control with HiSLIP](#)

11.2.1.3 VXI-11 Protocol

The VXI-11 standard is based on the ONC RPC (Open Network Computing Remote Procedure Call) protocol which in turn relies on TCP/IP as the network/transport layer. The TCP/IP network protocol and the associated network services are preconfigured. TCP/IP ensures connection-oriented communication, where the order of the exchanged messages is adhered to and interrupted links are identified. With this protocol, messages cannot be lost.

11.2.1.4 Socket Communication

An alternative way for remote control of the software is to establish a simple network communication using sockets. The socket communication, also referred to as "Raw Ethernet communication", does not necessarily require a VISA installation on the remote controller side. It is available by default on all operating systems.

The simplest way to establish socket communication is to use the built-in telnet program. The telnet program is part of every operating system and supports a communi-

cation with the software on a command-by-command basis. For more convenience and to enable automation by means of programs, user-defined sockets can be programmed.

Socket connections are established on a specially defined port. The socket address is a combination of the IP address or the host name of the instrument and the number of the port configured for remote-control. All R&S SMBV100B use port number 5025 for this purpose. The port is configured for communication on a command-to-command basis and for remote control from a program.

11.2.2 USB Interface

For remote control via the USB connection, the PC and the instrument must be connected via the USB type B interface. A USB connection requires the VISA library to be installed. VISA detects and configures the R&S instrument automatically when the USB connection is established. You do not have to install a separate driver.

USBTMC (USB Test & Measurement Class Specification) is a protocol that is built on top of USB for communication with USB devices, like GPIB. It defines class code information of the instrument, that identifies its functionality to load the respective device driver. Using VISA library, it supports service request, triggers, and other specific operations, similar to GPIB.

11.2.2.1 USB Resource String

The resource string represents an addressing scheme that is used to establish a communication session with the instrument. It is based on the instrument address and some instrument- and vendor-specific information.

The USB resource string syntax is as follows:

```
USB::<vendor ID>::<product ID>::<serial number>[:INSTR]
```

USB	= denotes the used interface
<vendor ID>	= is the manufacturer ID for Rohde & Schwarz
<product ID>	= is the product identification of the instrument
<serial number>	= is the individual serial number on the rear of the instrument
[:INSTR]	= indicates the instrument resource class (optional)

To set the USB resource string, see [Remote Access Settings](#).

Example:

```
USB::0x0AAD::0x01df::100001
```

0x0AAD is the vendor ID for Rohde & Schwarz.

0x01df is the product ID for the R&S SMBV100B

100001 is the serial number of the particular instrument.

11.2.3 GPIB Interface (IEC/IEEE Bus Interface)

To be able to control the instrument via the GPIB bus, the instrument and the controller must be linked by a GPIB bus cable. A GPIB bus card, the card drivers and the program libraries for the programming language used must be provided in the controller.

GPIB address

The controller must address the instrument with the GPIB bus channel (see [Chapter 11.4.3, "GPIB Address Settings"](#), on page 536). GPIB provides channel addresses from 0 to 30.

The GPIB resource string syntax is as follows:

`GPIB::<address>[:INSTR]`

GPIB = denotes the used interface
 <channel address> = the used channel
 [:INSTR] = indicates the instrument resource class (optional)

Note: If the VISA implementation supports the GPIB interface, you can optionally define the VISA Instrument Control Resource (INSTR). It is used to define the basic operations and attributes for a device, such as reading, writing, or triggering.

Notes and characteristics

In connection with the GPIB interface, note the following:

- Up to 15 instruments can be connected.
- The total cable length is restricted to a maximum of 15 m, or 2 m times the number of devices, whichever is less. The maximum recommended cable length between two instruments is 2 m.
- A wired "OR"-connection is used if several instruments are connected in parallel, since the slowest instrument determines the speed.



Any connected IEC bus cable must be terminated by an instrument or controller.

11.2.4 LXI Browser Interface

The LXI browser interface allows easy configuration of the LAN and remote control of the R&S SMBV100B without additional installation requirements. The instrument's LXI browser interface works correctly with all W3C compliant browsers.

See [Chapter 11.17.1, "LXI Functionality"](#), on page 575 for more about LXI.

The LAN settings are configured using the instrument's LXI browser interface described in [Chapter 11.5.2.1, "LAN Configuration"](#), on page 543. The LXI status settings in the R&S SMBV100B are described in [Chapter 11.5.1, "LXI Status Settings"](#), on page 541.

11.3 Remote Control Programs and Libraries

This section shows how the remote-control programs access the instrument, and the libraries they require for the appropriate interface protocols.

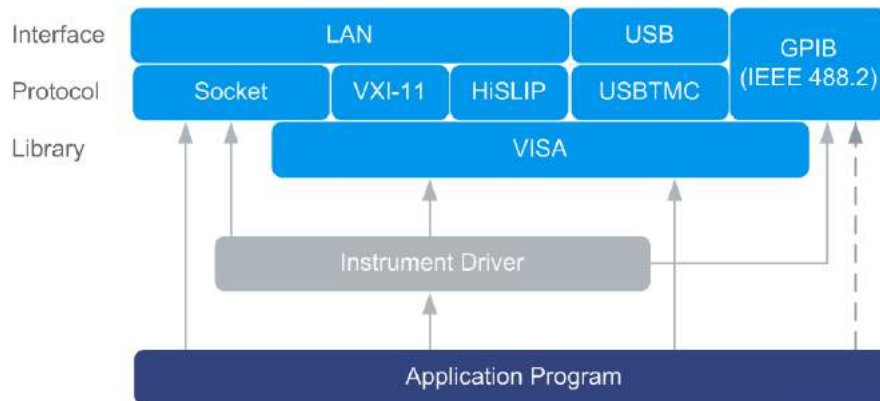

Figure 11-2: Overview of remote control interfaces, protocols and libraries

11.3.1 VISA Library

VISA is a standardized software interface library providing input and output functions to communicate with instruments. Thus, you can configure the interface without having to adjust the application program to the used interface. The I/O channel (LAN or TCP/IP, USB, GPIB,...) is selected at initialization time with the channel-specific address string ("VISA resource string"), or by an appropriately defined VISA alias (short name). See also [Table 11-2](#) for an overview.

Instrument access via VXI-11 or HiSLIP protocols is achieved from high level programming platforms using VISA as an intermediate abstraction layer. VISA encapsulates the low-level VXI or GPIB function calls and thus makes the transport interface transparent for the user.

A VISA installation is a prerequisite for remote control using the following interfaces:

- LAN interface using [HiSLIP Protocol](#)
- LAN interface using [VXI-11 Protocol](#)
- [USB Interface](#)

Instrument access via the LAN socket protocol or GPIB connections can be operated both, with or without the VISA library. See also [Chapter 11.2.1.4, "Socket Communication"](#), on page 525 and [Chapter 11.2.3, "GPIB Interface \(IEC/IEEE Bus Interface\)"](#), on page 527.

For more information about VISA library, refer to the user documentation.

11.3.2 Possible Setups and Access Functions

The following examples give an overview of dependencies between the available libraries, the possible interfaces and protocols, and whether an instrument driver is provided. The involved parts are **highlighted**. For more information, see the application note [1GP72: Connectivity of Rohde&Schwarz Signal Generators](#).

- Remote control (application) program using VISA

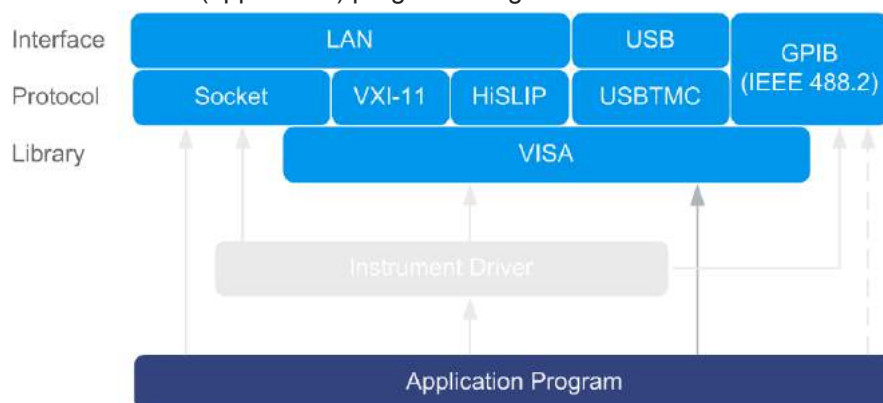

Figure 11-3: Application program using VISA

Protocol	Remote control program
Socket	<code>viOpen (... , "TCPIP:SMBV100B-102030::5025::SOCKET", ...)</code> <code>viPrintf (... , "SOUR:FREQ 2GHz\n")</code>
VXI-11	<code>viOpen (... , "TCPIP:SMBV100B-102030::inst0::INSTR", ...)</code> <code>viPrintf (... , "SOUR:FREQ 2GHz\n")</code>
HiSLIP	<code>viOpen (... , "TCPIP:SMBV100B-102030::hislip0::INSTR", ...)</code> <code>viPrintf (... , "SOUR:FREQ 2GHz\n")</code>
USBTMC	<code>viOpen (... , "USB::0x0AAD::0x01df::100001::INSTR", ...)</code> <code>viPrintf (... , "SOUR:FREQ 2GHz\n")</code>
GPIB	<code>viOpen (... , "GPIB::28::INSTR", ...)</code> <code>viPrintf (... , "SOUR:FREQ 2GHz\n")</code>

- Remote control program using instrument driver (VISA available)

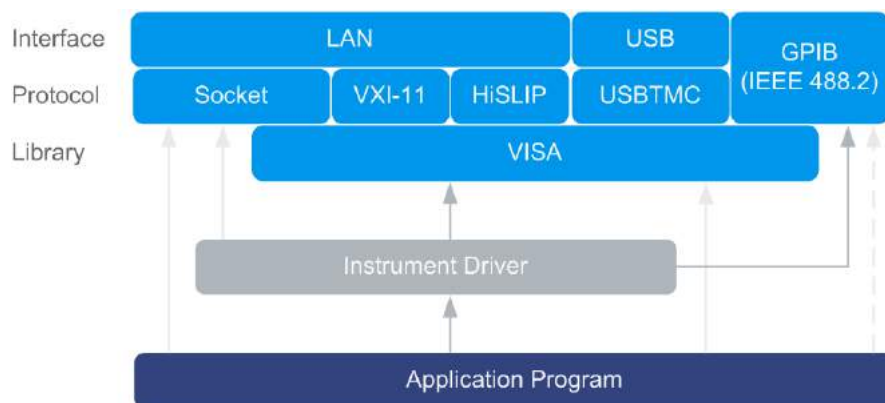

Figure 11-4: Application using instrument driver (VISA available)

Protocol	Remote control program
Socket	<code>rssmbv_init ("TCPIP:SMBV100B-102030::5025::SOCKET", ...)</code> <code>rssmbv_SetFrequency (... , 2e9)</code>
VXI-11	<code>rssmbv_init ("TCPIP:SMBV100B-102030::inst0::INSTR", ...)</code> <code>rssmbv_SetFrequency (... , 2e9)</code>
HiSLIP	<code>rssmbv_init ("TCPIP:SMBV100B-102030::hislip0::INSTR", ...)</code> <code>rssmbv_SetFrequency (... , 2e9)</code>
USBTMC	<code>rssmbv_init ("USB::0x0AAD::0x01df::100001::INSTR", ...)</code> <code>rssmbv_SetFrequency (... , 2e9)</code>
GPIB	<code>rssmbv_init ("GPIB::28::INSTR", ...)</code> <code>rssmbv_SetFrequency (... , 2e9)</code>

- Remote control program using instrument driver (VISA not available)

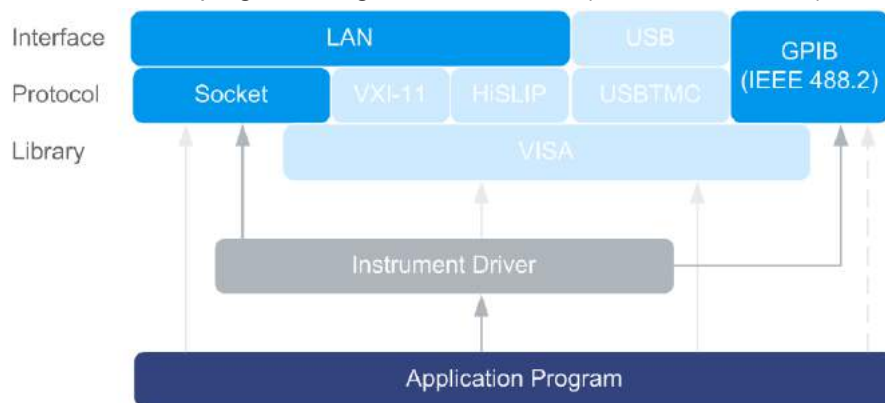

Figure 11-5: Remote control program using instrument driver (VISA not available)

Protocol	Remote control program
Socket	<pre>rssmbv_init ("TCPIP:SMBV100B-102030::5025::SOCKET", ...) rssmbv_SetFrequency (... , 2e9)</pre>
GPIB	<pre>rssmbv_init ("GPIB::28::INSTR", ...) rssmbv_SetFrequency (... , 2e9)</pre>

11.4 Remote Access Settings

This section outlines the settings required for accessing and configuring the provided remote control interfaces. It includes network settings, access addresses, emulation settings for using the command sets of other generators, and the access via smart devices.

About instrument emulations

You can also remotely control the R&S SMBV100B via the command set of another signal generator, as, for example, of an HP generator. With this function you can, for example, replace a signal generator with an R&S SMBV100B in an automated test setup, without adjusting the command scripts used.



The R&S SMBV100B also covers command sets of Rohde & Schwarz signal generators. To achieve optimal compatibility when replacing an instrument, we recommend that you select the emulation command set for the corresponding signal generator.

You find all the remote control command sets supported by the R&S SMBV100B in a selection list.

The selected instrument also defines the identification string that is retrieved with query `*IDN?`. If necessary, use the parameter **Mode** and **IDN String** to change this string.

As any other parameter, the remote control command set can also be changed remotely by the command `:SYSTem:LANGuage`.

While working in an emulation mode, the R&S SMBV100B specific command set is disabled and the SCPI command `:SYSTem:LANGuage` is discarded.

To return to the SCPI command set of the R&S SMBV100B, use the appropriate command of the selected command set. If for example an HP generator is emulated, the HP command `EX` returns to the instrument-specific GPIB command set.

11.4.1 Network Settings

NOTICE

Risk of network failure

Consult your network administrator before performing the following tasks:

- Connecting the instrument to the network
- Configuring the network
- Changing IP addresses

Errors can affect the entire network.

Access:

- ▶ Select "System Config > Remote Access > Network".

Net-work	Visa Res. Strings	GPIB Addr.	RS232	Instrument Emulations	Active Connections	QR-Code	X
Network Status							Restart Network
<div style="text-align: center;"> ● Connected </div>							
Instrument Name							
Hostname				Workgroup			
instrument				INSTRUMENT			
Instrument Address							
Address Mode							
Auto (DHCP)							
IP Address			Subnet Mask		Default Gateway		
10.124.0.211			255.255.252.0		10.124.0.1		
DNS Suffix			DNS Server		MAC Address		
rsint.net			10.0.2.166		08 00 27 b7 82 49		

In the "Network" dialog, you can configure the settings of the general network environment and specific identification parameters of the instrument in the network.

The remote commands required to configure the network remotely are described in [Chapter 12.17, "SYSTEM Subsystem"](#), on page 882.

How to connect the signal generator to the network is described in the [Chapter 2.1.4, "Setting Up a Network \(LAN\) Connection"](#), on page 37.

Network Status

Indicates that the instrument is connected to the network.

Remote command:

`:SYSTem:COMMunicate:NETWork:STATus?` on page 893

Restart Network

Terminates the network connection of the instrument and subsequently sets it up again. You can use this function to fix network problems.

Note: This function restarts only the connection of the instrument to the network. It does not impact the network itself.

Remote command:

`:SYSTem:COMMunicate:NETWork:REStart` on page 893

Hostname

Displays the hostname.

Each instrument is delivered with an assigned hostname, a logical name which can be used instead of the IP address. With the default network settings, the IP address is allocated by the DHCP server. This address can change each time the instrument is reconnected. Unlike the IP address, the hostname name does not change.

Note:

This function is password-protected. Unlock the protection level 1 to access it.

- We recommend that you do not change the default network settings or the hostname to avoid problems with the network connection.
If you change the hostname, be sure to use a unique name.

Remote command:

`:SYSTem:COMMunicate:NETWork[:COMMON]:HOSTname` on page 893

Workgroup

Sets the individual windows workgroup name of the R&S SMBV100B. This parameter is required in case the instrument is integrated in a windows network.

This function is password-protected. Unlock the protection level 1 to access it.

Remote command:

`:SYSTem:COMMunicate:NETWork[:COMMON]:WORKgroup` on page 894

Address Mode

Selects the mode for assigning the IP address.

NOTICE! Risk of network failure.

Consult your network administrator before performing the following tasks:

- Connecting the instrument to the network
- Configuring the network
- Changing IP addresses

Errors can affect the entire network.

"Auto (DCHP)"

Assigns the IP address automatically, provided the network supports DHCP (Dynamic Host Configuration Protocol).

"Static"

Enables you to assign the IP address manually.

Remote command:

`:SYSTem:COMMunicate:NETWork:IPAddress:MODE` on page 892

IP Address

Displays the IP address of the instrument in the network.

By default, the R&S SMBV100B is configured to use dynamic TCP/IP configuration and to obtain the whole address information automatically.

If the network does not support DHCP or the attempt does not succeed, the instrument tries to obtain the IP address via Zeroconf (APIPA) protocol. IP addresses assigned via Zeroconf start with the number blocks 169.254.*.*.

Note: An IP address that is assigned via the Zeroconf protocol although the network requires an IP address assigned via the DHCP server can cause network connection failures.

See [Chapter 14.5, "Resolving Network Connection Failures"](#), on page 943.

To assign the IP address manually, select [Address Mode](#) > "Static".

Remote command:

`:SYSTEM:COMMunicate:NETWork:IPADdress` on page 892

Subnet Mask

Displays the bit group of the subnet in the host identifier.

To assign the subnet mask manually, select [Address Mode](#) > "Static".

Remote command:

`:SYSTEM:COMMunicate:NETWork[:IPADdress]:SUBNet:MASK` on page 894

Default Gateway

Displays the gateway address.

This address identifies the router on the same network as the instrument that is used to forward traffic to destinations beyond the local network.

To assign the gateway address manually, select [Address Mode](#) > "Static".

Remote command:

`:SYSTEM:COMMunicate:NETWork[:IPADdress]:GATeway` on page 894

DNS Suffix

Displays the primary DNS (Domain Name System) suffix, that means the DNS name without the hostname part.

The DNS system uses the suffix for registration and name resolution for unique identification of the instrument in the entire network.

To assign the DNS suffix manually, select [Address Mode](#) > "Static".

Remote command:

`:SYSTEM:COMMunicate:NETWork[:COMMON]:DOMain` on page 893

DNS Server

Determines the preferred server for name resolution. The DNS server contains the underlying numerical values that are required for name resolution of the hostname as part of the IP address.

To select the DNS server manually, select [Address Mode](#) > "Static".

Remote command:

`:SYSTEM:COMMunicate:NETWork[:IPADdress]:DNS` on page 894

MAC Address

Indicates the MAC (Media Access Control) address, a unique identifier of the network adapter in the R&S SMBV100B.

Remote command:

:SYSTem:COMMunicate:NETWork:MACaddress on page 892

11.4.2 Visa Resource Strings

Access:

- ▶ Select "System Config > Remote Access > Visa Resource Strings".

HISLIP	TCPIP::10.113.0.105::hislip0::INSTR
VXI11	TCPIP::10.113.0.105::inst0::INSTR
Socket	TCPIP::10.113.0.105::5025::SOCKET
GPIB	GPIB::28::INSTR
USB	USB::0x0AAD::0x01dd::0::INSTR
SERIAL	ASRL1::INSTR

The "Visa Resource String" dialog displays the Visa resource strings provided for remote control via the different interfaces.

Remote command:

:SYSTem:COMMunicate:HISLip:RESource? on page 892

:SYSTem:COMMunicate:NETWork:RESource? on page 893

:SYSTem:COMMunicate:SOCKet:RESource? on page 896

:SYSTem:COMMunicate:GPIB:RESource? on page 891

:SYSTem:COMMunicate:USB:RESource? on page 896

:SYSTem:COMMunicate:SERial:RESource? on page 895

11.4.3 GPIB Address Settings

Access:

1. Select "System Config > Remote Access > GPIB Address".



2. Set the GPIB channel address of the connected instrument.

Remote command:

`:SYSTEM:COMMunicate:GPIB[:SELF]:ADDRESS` on page 891

11.4.4 RS232 Settings

Remote control via a serial interface is possible via a USB. The controller and the instrument must be connected with the external USB/serial-adapter R&S TS1-USB (see recommended extras in the data sheet) and a serial crossover (null modem) cable. A USB connection requires the Visa library to be installed on the controller. Visa detects and configures the R&S SMBV100B automatically when the USB connection is established.

Access:

- ▶ Select "System Config > Remote Access > RS232".



In the "RS232" dialog, you can configure the settings of the serial interface.

The remote commands required to configure the settings remotely are described in [Chapter 12.17, "SYSTEM Subsystem"](#), on page 882.

Baud Rate

Sets the baudrate for the serial remote control interface.

Remote command:

`:SYSTEM:COMMunicate:SERial:BAUD` on page 895

Parity

Sets the parity for the serial remote control interface.

Remote command:

`:SYSTEM:COMMunicate:SERial:PARity` on page 895

Stop Bits

Sets the number of stop bits for the serial remote control interface.

Remote command:

:SYSTem:COMMunicate:SERial:SBITs on page 895

11.4.5 Instrument Emulations Settings

Access:

- ▶ Select "System Config > Remote Access > Instrument Emulations".

The "Instrument Emulations" dialog enables you to emulate a remote control command set of another signal generator.

The remote commands required to configure the emulation settings remotely are described in [Chapter 12.17, "SYSTem Subsystem"](#), on page 882.

Language

Selects the instrument whose remote command set is emulated by the R&S SMBV100B.

Remote command:

:SYSTem:LANGuage on page 898

Mode

Selects the way the instrument identification is performed.

"Automatic" Sets the "IDN String" and the "OPT String" automatically for the instrument selected with the parameter [Language](#).

"User Defined" Enables you to define the "IDN String" and the "OPT String".

Remote command:

:SYSTem:IDENTification on page 896

Set to Default

In "Mode > User Defined", resets the *IDN and *OPT strings.

Remote command:

[:SYSTem:IDENtification:PRESet](#) on page 897

IDN String

Indicates the identification string of the instrument when queried with the common command *IDN?.

In addition to the preset values, you can define your own identification string so that each generator uses an individual identification, like `My_SigGen` for instance, see [Mode](#) .

Remote command:

[*IDN?](#) on page 582

[:SYSTem:IRESpOnse](#) on page 897

OPT String

Indicates the option string of the instrument as queried with common command *OPT?.

In [Mode](#) > "User Defined", you can define your own option string, additionally to the automatically created one.

Remote command:

[*OPT?](#) on page 582

[:SYSTem:ORESpOnse](#) on page 897

11.4.6 Active Connections Settings

Access:

- ▶ Select "System Config > Remote Access > Active Connections".

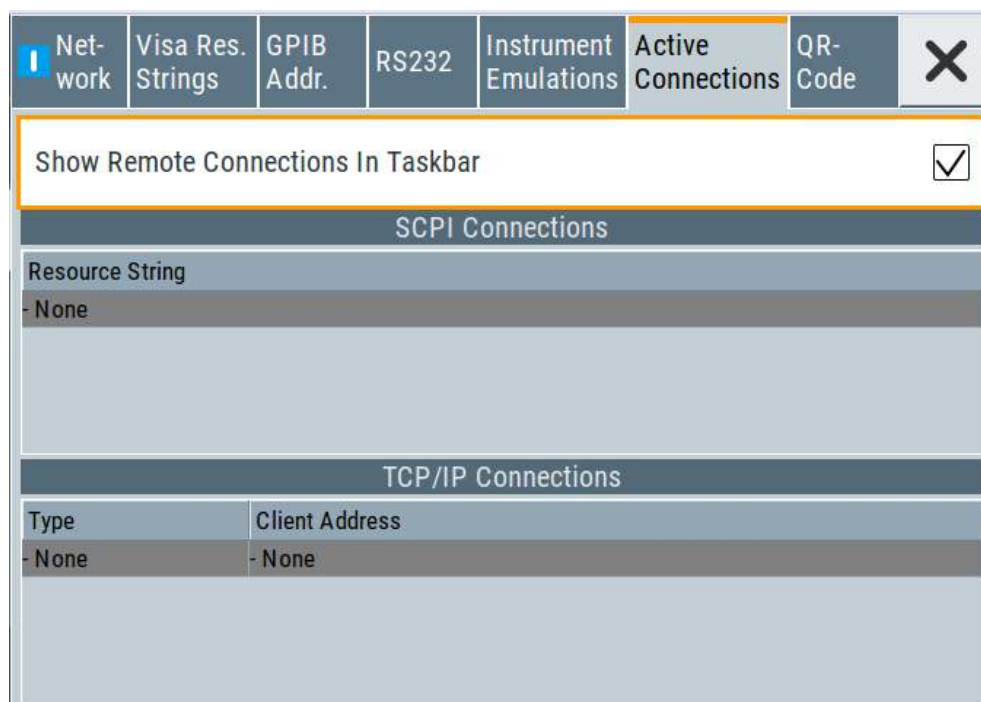

The "Active Connections" dialog indicates all active SCPI and TCP/IP connections.

Show Remote Connections in Taskbar

Displays the currently active connections in the taskbar.

SCPI Connections

Shows the active VISA resource string of the interface via which the instrument is remotely controlled.

Remote command:
n.a.

TCP/IP Connections

Shows the type and client address of the LAN interface connection.

Remote command:
n.a.

11.4.7 QR Code

Access:

- ▶ Select "System Config > Remote Access > QR Code".



The "QR Code" dialog shows the current instrument address (IP address) in quick response (QR) format.

This functionality provides fast access to the instrument via VNC with, for example, a smartphone or a tablet.

See [Chapter 11.16.2, "Setting Up a Remote Operation from a Smart Device"](#), on page 572.

11.5 LXI Settings

On the R&S SMBV100B the LXI functionality is already installed and enabled, see [LXI Status Settings](#). Thus, the instrument can be accessed via any web browser (like the Microsoft Internet Explorer) to perform the following tasks:

- Modifying network configurations
- Remote control the instrument
- Performing SCPI remote diagnostics

The LAN settings are configured using the instrument's LXI browser interface described in [Chapter 11.5.2.1, "LAN Configuration"](#), on page 543.

11.5.1 LXI Status Settings

Access:

- ▶ Select "System Config > Setup > Remote Access > LXI Status...".

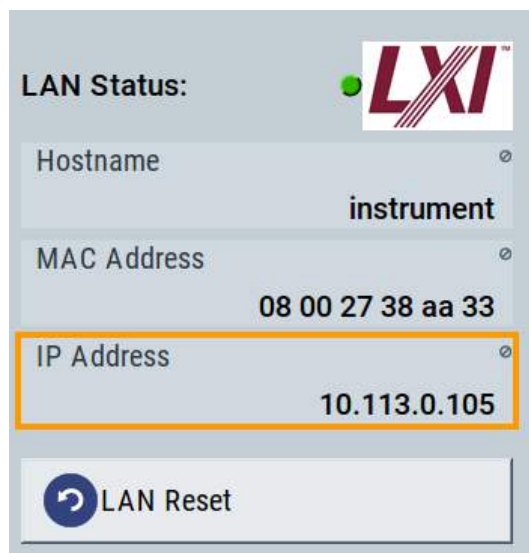

The "LXI - Status" dialog shows the parameters of the LAN connection.

Alternatively, you can change the LAN settings using the LXI web browser interface, see [Chapter 11.5.2.1, "LAN Configuration"](#), on page 543.

LAN Status

The LED indicates the LXI status.

"green"	Normal operation
"green (flashing)"	Device identification
"red"	LAN fault

Hostname / MAC Address / IP Address

See ["Hostname"](#) on page 533.

LAN Reset

Initiates the network configuration reset mechanism for the instrument and resets the hostname, MAC address, and IP address.

According to the LXI standard, a LAN reset must place the following network settings to a default state:

Parameter	Value
TCP/IP mode	DHCP + Auto IP address
Dynamic DNS	Enabled

Parameter	Value
ICMP ping	Enabled
Password for LAN configuration	LxiWebLfc

The LAN reset also resets the following parameters for the vector signal generator:

Parameter	
Hostname	Instrument-specific hostname
Description	Vector signal generator
Negotiation	Auto detect
VXI-11 discovery	Enabled

11.5.2 LXI Browser Settings

To access the instrument via the web browser:

- ▶ In the address field of the browser on your PC, type the instrument's host name or IP address, for example *http://10.113.1.151*.

Note: Do not add the missing zeros in the IP address, while opening the instrument homepage.

The instrument homepage (welcome page) opens.

The navigation pane of the browser interface contains the following elements:

- "LXI"
 - "Home" opens the instrument homepage.
The homepage displays the device information required by the LXI standard, including the VISA resource string in read-only format.
 - "Device Indicator" activates or deactivates the LXI status indication.
When activated, the LXI LEDs flash, both in the browser dialog and in the LXI dialog of the connected instrument, see [LAN Status](#). A green LXI status symbol indicates that a LAN connection has been established; a red symbol indicates that no LAN cable is connected.
 - "Lan Configuration" allows you to configure LAN parameters and to initiate a ping, see ["Ping Client"](#) on page 545.
 - "Status" displays information about the LXI status of the instrument.
 - "Utilities" provides access to the LXI event log functionality required by the LXI standard.
- "Instrument Control"
 - "Web Control" provides remote access to the instrument, see ["Starting a remote control via the LXI web browser"](#) on page 549.
- "Diagnostics"
 - "SCPI Remote Trace" records messages exchanged via the remote control interface, see ["SCPI Remote Trace"](#) on page 545.
- "Help"
 - "Glossary" explains terms related to the LXI standard.

- www.rohde-schwarz.com opens the Rohde & Schwarz homepage.
- "Data Sheet"
 - Provides the data sheet with the specification data of the instrument at the time of delivery, see "Data Sheet" on page 546.

11.5.2.1 LAN Configuration

The "LAN Configuration" web page displays all mandatory LAN parameters and allows their modification.

It comprises the following navigation entries.

• IP Configuration	543
• Advanced Config	544
• Ping Client	545
• SCPI Remote Trace	545
• Data Sheet	546

IP Configuration

The "IP configuration" web page displays all mandatory LAN parameters and allows their modification.

The "IP Address Mode" selects a configuration mode for the IP address of the instrument. With static configuration, the entered IP address, subnet mask, and default gateway are used. With dynamic configuration, DHCP or dynamic link local addressing (automatic IP) is used to obtain the instrument IP address.



Changing the LAN configuration

This function is password-protected. Unlock the protection level 1 to access it.

Note: We recommend that you change the default password before connecting the instrument to a network.

See [Chapter 10.5.4, "Password Management"](#), on page 515.

Advanced Config

The "Advanced Config" web page provides LAN settings that are not declared mandatory by the LXI standard.

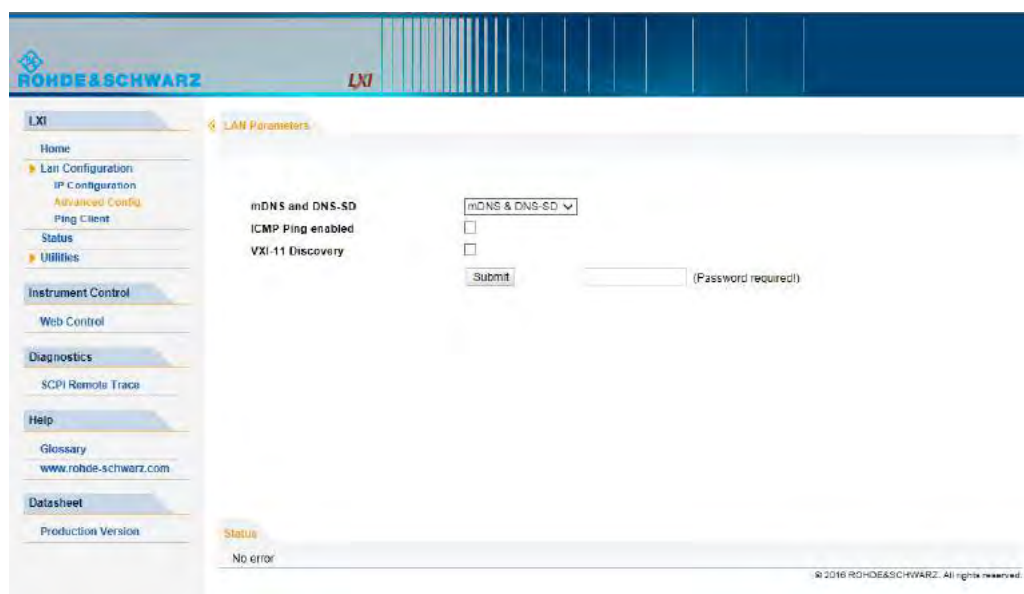

The following advanced parameters are available:

- "mDNS and DNS-SD": The additional protocols "multicast DNS" and "DNS service discovery" are used for device communication in zero configuration networks, working without DNS and DHCP.
- "ICMP Ping": Must be enabled to use the ping utility. If you disable this setting, the instrument does not answer ping requests. The setting does not affect the LXI ping client. You can ping other hosts from the instrument, even if the setting is disabled.
- "VXI-11 Discovery": Must be enabled to detect the instrument in the LAN. If you disable this setting, the instrument cannot be detected by the VXI-11 discovery protocol mechanism. The setting does not affect other detection mechanisms. Setting up a VXI-11 connection via the IP address or the host name is independent of this setting.



Changing the LAN configuration

This function is password-protected. Unlock the protection level 1 to access it.

Note: We recommend that you change the default password before connecting the instrument to a network.

See [Chapter 10.5.4, "Password Management"](#), on page 515.

Ping Client

The "Ping Client" page provides the ping utility to verify the connection between the LXI-compliant instrument and another device.

The ping is initiated from the instrument. Using the ICMP echo request and echo reply packets, this function checks whether the communication with a device via LAN is working. Ping is useful for the diagnosis of IP network or router failures.

To initiate a ping at the instrument:

1. On the "Ping Client" page, enter the IP address of the host in the "Destination Address" field (for example 10.113.1.151).
2. Select "Submit".



SCPI Remote Trace

The remote trace functionality allows you to trace input and output strings at the remote control interface of the R&S SMBV100B, see [Chapter 11.9, "Tracing SCPI Commands and Messages Exchanged via the LXI Web Browser Interface"](#), on page 557.

A recorded trace (message log) can be evaluated directly in the dialog. Use the highlighting and navigation functions provided by the lower toolbar to locate error mes-

sages and messages containing arbitrary search strings. You can also export the message log to a *.CSV file and evaluate the file using a suitable program.

To trace and display messages, switch on "logging" and "live mode" in the toolbar.

Toolbars

The toolbar at the top of the dialog provides basic settings and functions.

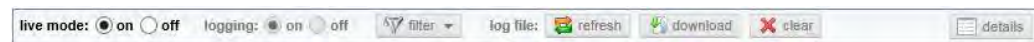

- "Live mode" / "logging": If logging is switched on, messages are traced. They are stored in an internal database and can be displayed upon request, using the refresh button (live mode off) or they can be displayed automatically (live mode on).
- "Filter": applies a filter to columns and/or rows when working (live mode off)
- "Refresh": reads the message log from the internal database and displays it
- "Download": stores the SCPI trace log to a *.CSV file
- "Clear": deletes all message log entries in the database and at the screen
- "Details": displays details of the selected message, for example an SCPI command in hex format (also possible by double-clicking a message)

Columns

The following columns are available if no column filter is applied:

- "Rec": record number of the message within the message log
- I: number of the subinstrument
- "MT": indicates the type of the message. Possible values and related message contents are:
 - > = incoming command
 - < = outgoing response to a query
 - E = error message, highlighted by red color
 - T = execution time, i.e. time required by the instrument to process the command internally.
- "message": indicates the type of the message. Possible values and related message contents are:
 - > = incoming command
 - < = outgoing response to a query
 - E = error message, denoted in red
 - T = execution time, i.e. time required by the instrument to process the command internally

Data Sheet

The data sheet functionality allows you to retrieve the specification data of the instrument at the time of delivery.

The document contains all specified value ranges and information of the data sheet, for example important as reference values for recalibration.

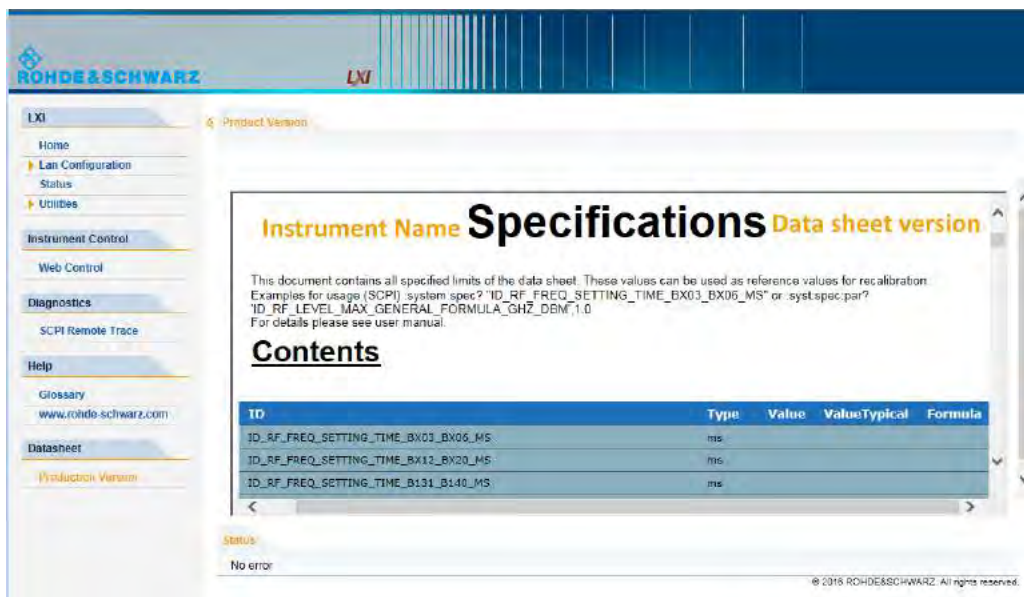

11.6 How to Find the VISA Resource String

- ▶ Select "System Config > Remote Access > VISA Resource Strings".

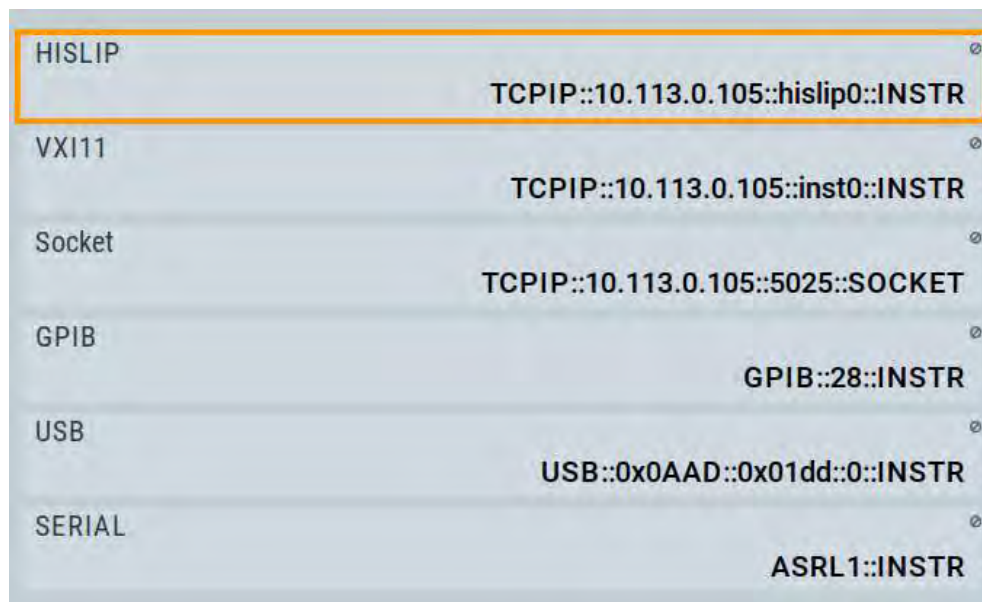

The dialog shows all specified resource strings of the supported remote control interfaces.



- For information on how to assign the IP address manually, see [Chapter 2.1.4.3, "Assigning the IP Address"](#), on page 39.
- Also note that using the RS232 serial interface via USB requires the USB serial adapter R&S TS-USB1.

11.7 How to Change the GPIB Instrument Address

To control the instrument remotely via the GPIB bus, it must be addressed using the GPIB address. The remote control address is factory-set to 28, but it can be changed if it does not fit in the network environment. For remote control, addresses 0 through 30 are allowed. The GPIB address is maintained after a reset of the instrument settings.

To set the GPIB address:

1. Select "System Config > Remote Access > GPIB Address".
2. Select "GPIB Channel Address" and enter a value between 0 and 30.



Risk of losing remote connection

If the remote access and network settings had been configured to values different to the default, executing a factory preset via remote control terminates the connection to the instrument.

11.8 How to Set Up a Remote Control Connection

This section guides you through the steps required to set up remote control connections of the available interfaces.

- [Chapter 11.8.1, "Establishing a Remote Control Connection over the LXI Browser Interface"](#), on page 549
- [Establishing a Remote Control Connection over LAN Using VXI-11 Protocol](#)
- [Setting Up a Remote Control Connection over LAN Using Socket Communication](#)
- [Setting Up a Remote Control Connection over GPIB](#)
- [Setting Up a Remote Control Connection over USB](#)

The instrument and the controller have to be connected with the suitable cable and switched on.

A remote control program must open a connection to the instrument, before it can send commands to and receive device responses from the instrument.



Instrument address

To operate the instrument via remote control, it must be addressed using the defined interface address.

See:

- [Chapter 11.2.1, "LAN Interface"](#), on page 523
- [Chapter 11.2.2, "USB Interface"](#), on page 526
- [Chapter 11.2.3, "GPIB Interface \(IEC/IEEE Bus Interface\)"](#), on page 527

You find the VISA resource strings in the "System Config > Remote Access > VISA Resource Strings" dialog.



Securing the display

To prevent unauthorized personnel from reading the display, you can disable the frequency and level display explicitly. This is useful when you remotely control the instrument from a different location.

For more information, see:

- ["Annotation Frequency"](#) on page 511
- ["Annotation Amplitude"](#) on page 511

11.8.1 Establishing a Remote Control Connection over the LXI Browser Interface

Via the LXI browser interface to the R&S SMBV100B one or more users can control the instrument remotely from another PC without additional installation. Most instrument controls are available via the front panel simulation. File upload and download between the instrument and the remote PC is also available.

Starting a remote control via the LXI web browser

This section assumes that the instrument and the controller PC are connected in the LAN.

1. Start a web browser that supports HTML5 (W3C compliant).
2. Enter the IP address of the R&S SMBV100B in the browser's address bar.
The R&S SMBV100B's welcome page is displayed.
3. In the navigation pane, select "Instrument Control" > "Web Control".
Remote access to the instrument requires the password. The default password is *instrument*.
4. Enter the password and confirm with the [Enter] key.
After the connection is established, the current screen of the R&S SMBV100B is displayed in the browser window.

5. Use the mouse cursor and keyboard to access the functionality of the instrument as you would directly perform on the instruments touchscreen and front panel.

11.8.2 Establishing a Remote Control Connection over LAN Using VXI-11 Protocol

In this example, the I/O software library R&S VISA from Rohde & Schwarz is used to set up a LAN remote control link and remotely control the R&S SMBV100B. R&S VISA is running on a controller PC with Windows operating system. When the connection is set up, you can send commands to the instrument and receive the responses.

The remote control connection requires a VISA installation but no additional hardware on the controller PC. The LAN I/O channel is selected at initialization time using the VISA resource string (also referred to as "address string"). A VISA alias (short name) is used to replace the complete resource string. The host address is the R&S SMBV100B's hostname or its IP address.

See also [Chapter 11.2.1, "LAN Interface"](#), on page 523.

In the following, we assume that:

- A LAN remote control link between the controller and the R&S SMBV100B is set up.
- The R&S VISA program is installed on the remote PC
See <http://www.rohde-schwarz.com/rsvisa> > "RS VISA Release Notes".

Setting up the controller with R&S VISA

To remote control the R&S SMBV100B, we use the R&S VISA Tester application. The application communicates via TCP/IP protocol.



The instrument is preconfigured for networks using DHCP (dynamic host configuration protocol). If this configuration is used, enter the computer name in the position of the IP address.

1. Connect the controller and the instrument in the same network (network cable). Switch them on.
2. On the controller, start "R&S VISA > Tester 32bit" or "R&S VISA > Tester 64bit".

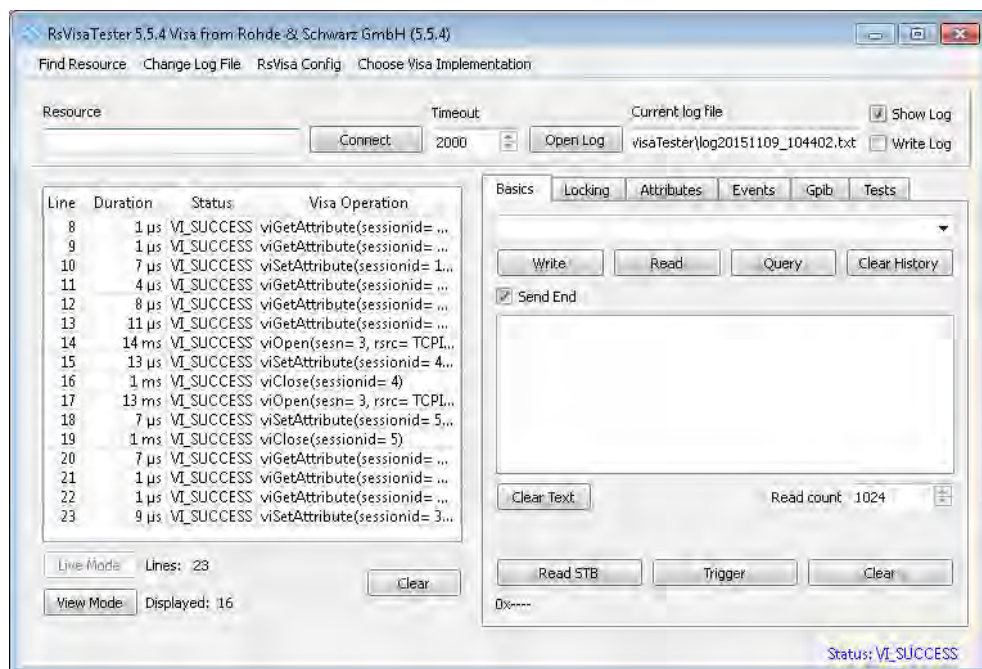

3. In the menu bar, select "Choose VISA Implementation > Rohde & Schwarz Visa" and confirm with "OK".

4. In the menu bar, select "Find Resource" to search for the instrument in the LAN.

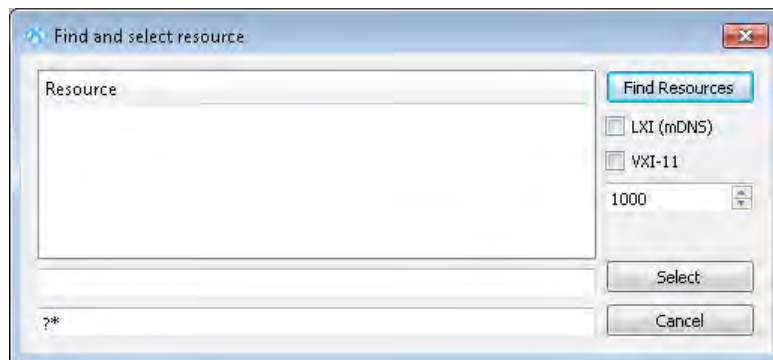

5. Select "VXI-11" and "Find Resources".

R&S VISA scans the network for connected instruments and lists all detected instruments in the "Resource" list.

Note: The search may take some time, particularly in large networks.

6. Select the required instrument and confirm with "Select".

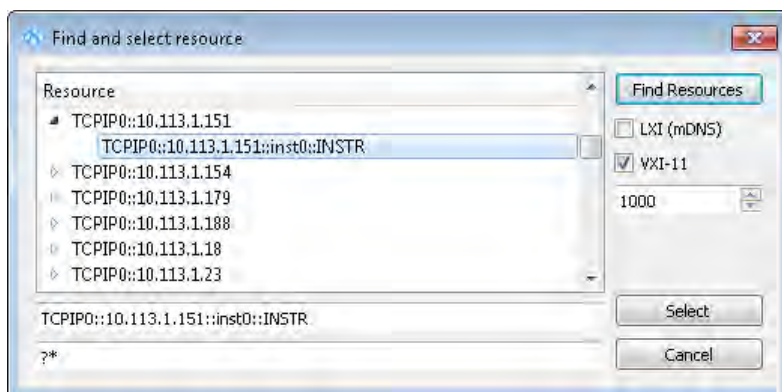

The "Find and select resource" dialog closes and R&S VISA indicates the IP address in the "Resource" field of the main application window.

7. As an alternative to the IP address, you can assign an alias name to the R&S SMBV100B:

- a) In the menu bar, select "RsVisaConfig".

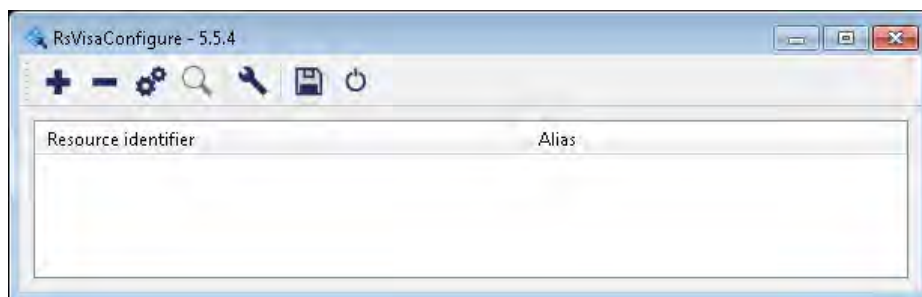

- b) In the toolbar, select "+" to access the "VISA Resource String Composer".

- c) Fill in the "Alias" name, the "VISA Resource String" and the "Device IP Address or host name" as shown in the figure, and confirm with "OK".

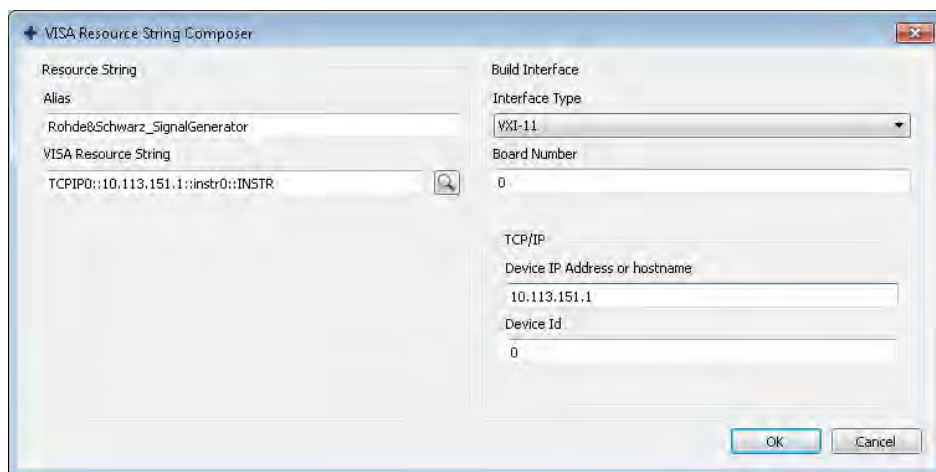

The "Alias" name is assigned.

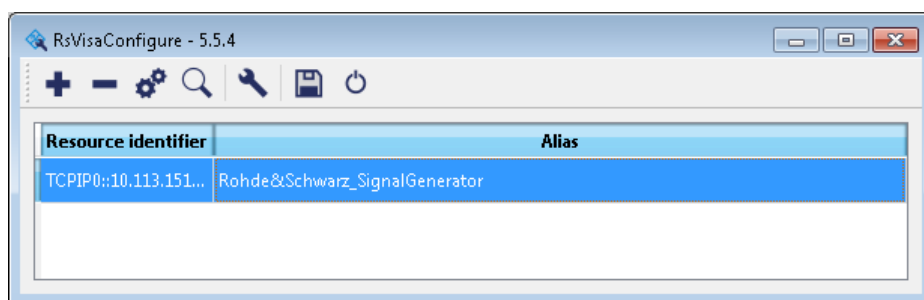

- d) Close the dialog.
The R&S SMBV100B is registered in the program. It can be addressed via the resource string or alias name.

8. In the main window, select "Connect".

R&S VISA establishes the connection to the R&S SMBV100B.

You can send settings to configure the instrument and receive its responses.

Note: If the connection cannot be set up, R&S VISA displays an error in the log view.

For information on how to proceed when network failures occur, see [Chapter 14.5, "Resolving Network Connection Failures"](#), on page 943.

For further information on the functions to read and write to an open session, and the utility applications the software provides, see the R&S VISA user manual.

Starting a remote control session over LAN with R&S VISA

To set the instrument to remote control, you can use the addressed command `>R` or send any command from the controller.

1. Start the R&S VISA Tester. Establish the connection to the R&S SMBV100B. See ["Setting up the controller with R&S VISA"](#) on page 550.

- In the R&S VISA "Basics" tab, enter an SCPI command, e.g. "*IDN?". Confirm with "Query".

The instrument is switched to remote control when it receives a command from the controller.

- Select "Read" to obtain the instrument response.

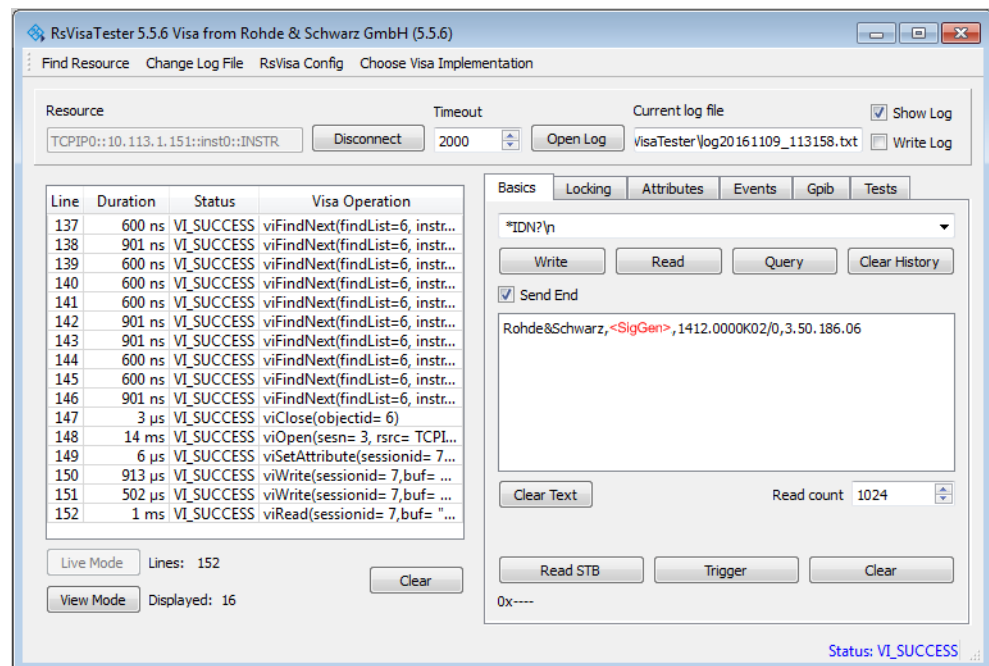

Tip: If the "Show Log" checkbox is checked, R&S VISA displays each VISA function call in the log-view on the left. If you check the "Write Log" checkbox, the log-view entry is written to the log file as well. You can operate the log-view in two modes: the "Live Mode" shows only the most recent messages whereas the "View Mode" allows you to scroll the history.

- To set, e.g. the frequency, enter `SOUR1:FREQ 4 GHz` and select "Write". To check the performed setting, `SOUR1:FREQ?` and select "Query". The instrument response is `4000000000`. The value corresponds to the frequency in Hz.

While remote control is active, the "Remote" icon in the status bar indicates that the instrument is in remote control mode. Currently ongoing communication (data transfer) is indicated by green colored arrows in the icon.

Operating via the front and touch panel or via mouse and keyboard are locked, allowing a remote control program to be performed without interruption. On the display, keys and entry fields are grayed out and cannot be activated or modified, but you can still open dialogs, for example to verify settings.

- To disable the access to the dialogs, use the command `SYST:KLOC ON`.
- To prevent unintentional return to manual operation, use the command `&LLO`. See also [Chapter A.1.2, "LAN Interface Messages"](#), on page 947.

The instrument switches to "Remote LLO" state. The [Setup] key is disabled.

7. To enable the [Setup] key, use the command `>R`.
8. To return to manual operation, see [Chapter 11.10, "How to Return to Manual Operation"](#), on page 558.

Tip: Switching from manual operation to remote control and vice versa does not affect the other instrument settings.

11.8.3 Setting Up a Remote Control Connection over LAN Using Socket Communication

This section provides an example on how to establish a remote control connection over Telnet client and a simple sockets-based program example that can be further developed (see also [Chapter A.2, "Telnet program examples"](#), on page 967).



The telnet client transmits information unencrypted. Therefore, for sensitive information we recommend that you use a client which supports secure protocols, like SSH.

In the following example, we assume basic knowledge of programming and operation of the controller. You can find information on the interface commands in the corresponding manuals.

Setting up a Telnet connection

To control the software, only a Telnet program is required. The Telnet program is part of every operating system.

1. To establish a Telnet connection with the R&S SMBV100B, start the Telnet program. Enter the socket address.
The socket address is a combination of the IP address or the hostname of the R&S SMBV100B and the number of the port configured for remote-control via Telnet.
Tip: The R&S SMBV100B uses the port number 5025 for remote connection via Telnet.

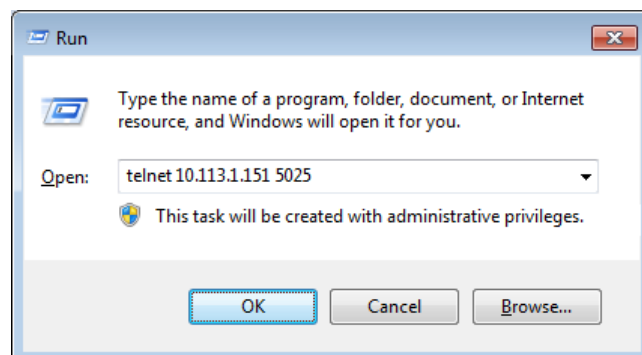

The connection to the instrument is set up and you can send remote-control commands.

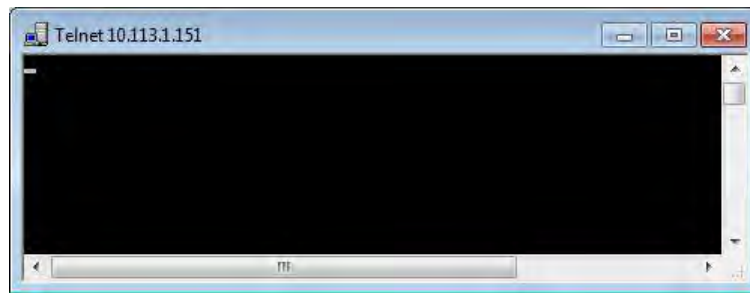

2. Note that Telnet does not reflect your first entry. Insert a command, e.g. *IDN and confirm with "Enter".
3. Observe the screen.
A response on the query confirms that the connection is working. The client displays all subsequent inputs and responses.
4. Even if the cursor is not visible on the screen, blindly enter a remote-control command. Confirm with Enter.

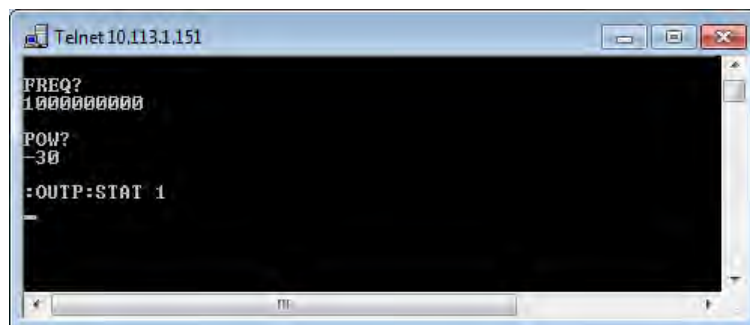

11.8.4 Setting Up a Remote Control Connection over GPIB

The program example in this section is written in VISUAL BASIC. A condition for programming in VISUAL BASIC is that the modules NIGLOBAL (Niglobal.bas) and VBIB32 (Vbib_32.bas) are added to the projects.



Drivers for instrument, for example IVI-COM and LabVIEW drivers, are available for download area on the product page at:

<https://www.rohde-schwarz.com/driver/smbv100b/>

Starting a remote control session over GPIB

As a prerequisite, the GPIB address of the instrument must be the default value, which is factory-set to 28.

1. Connect instrument and controller using a GPIB cable. Switch them on.
2. Execute the following commands on the controller:

- a) Open the port to the instrument.
`CALL IBFIND("DEV1", generator%)`
- b) Inform the controller about instrument address.
`CALL IBPAD(generator%, 28)`
- c) Reset the instrument.
`CALL IBWRT(generator%, "*RST;*CLS")`
- d) Set the instrument to new address.
`CALL IBWRT(generator%, "SYST:COMM:GPIB:ADDR 18")`
- e) Inform the controller about new address.
`CALL IBPAD(generator%, 18)`

The GPIB address of the instrument is changed.

3. To return to manual operation, press the Local key at the front panel.

11.8.5 Setting Up a Remote Control Connection over USB

For remote control via the USB connection, the PC and the instrument must be connected via the USB type B interface. A USB connection requires the VISA library to be installed. VISA detects and configures the R&S instrument automatically when the USB connection is established. You do not have to enter an address string or install a separate driver.

Starting a remote control session over USB

1. Connect instrument and controller using USB cable. Switch them on.
2. Execute the following commands on the controller:
 - a) Open the port to the instrument.
`viOpen (... , "USB::0x0AAD::0x01df::100001::INSTR", ...)`
 - b) Reset the instrument.
`viRST (generator%, "*RST;*CLS")`
 - c) Set 2 GHz frequency
`viPrintf (... , "SOUR:FREQ 2GHz\n")`
 - d) Set 20 dBm output level
`viPrintf (... , "SOUR:POW -20dBm\n")`

The RF frequency and signal level of the instrument are changed.

3. To return to manual operation, press the [Local] key.

11.9 Tracing SCPI Commands and Messages Exchanged via the LXI Web Browser Interface

The remote trace functionality allows you to trace commands and messages exchanged via a remote control interface of the R&S SMBV100B.

To activate the SCPI remote trace:

1. Start a web browser that supports HTML5 (W3C compliant).
2. Enter the IP address of the R&S SMBV100B in the browser's address bar.
The R&S SMBV100B's welcome page is displayed.
3. In the navigation pane, select "Diagnostics > SCPI Remote Trace".
4. In the toolbar bar of the "SCPI Remote Trace" page, select "live mode > on" and "logging > on".

"live mode > on" displays all commands and responses, and "logging > on" also traces messages.

If you now control the R&S SMBV100B with SCPI commands, using an appropriate tool, the LXI function records the information sent and received.

The function records all sent commands, received responses and messages, and saves them in an internal database. If "live mode" is disabled, you can display the recent traces upon request, using the "refresh" button. You can also save the log in a file.

Note: The diagnostics functionality will be extended in later releases, e.g. to download or upload SCPI command files from / to the instrument.

11.10 How to Return to Manual Operation



Before returning to manual control, command processing must be completed. Otherwise, the instrument switches back to remote control immediately.

1. To return from "Remote" state to manual state, perform one of the following:
 - On the controller, use the command `>L`
 - **Note:** If `&NREN` has been set before `>L` is locked. Use `>R` instead.
 - In the status bar, select the "Remote" icon.
 - On the front panel, press the [Local] key.
 - In the block diagram, select "Context sensitive menu > Key Emulation > Local"

2. To return from "Remote LLO" state to manual or to "Remote" state, perform one of the following:

Note: In the local lockout state, the command `>L` and the [Local] key are locked. You can unlock this state only via remote control.

- On the controller, use the command `&LOCS`.
This command switches directly to manual operation.
- Send the command `&REMS`.
This command changes the remote control state from "Remote LLO" to "Remote".
- Use the Visual Basic command `CALL IBLOC (generator%)`.

- The command switches directly to manual operation.
- VISA function `viGpibControlREN()`
This function switches directly to manual operation.

11.11 Automating Tasks with Remote Command Scripts

To achieve fast configuration, make complex test setups or repeating measurements reproducible, you can automate the required settings with scripts. A script contains a series of SCPI commands corresponding to the settings. When completed, it is converted to an executable format, saved in a file and can be run whenever needed.



If you frequently need to load and run a script, assign the script to the [★ (User)], and you can quickly and easily perform the task.

See [Chapter 10.3.3, "Assigning Actions to the \[★ \(User\)\] Key"](#), on page 500.

Note: In contrast to "Recall Setup" via the [★ (User)] key, an assigned script execution does not close active dialogs and windows. On the contrary, even active window control (open / close) is possible.

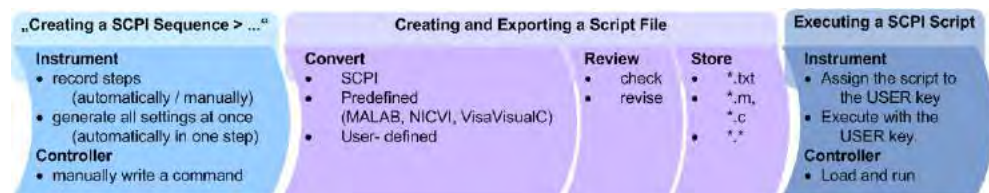

Figure 11-6: Steps for performing SCPI Scripts

In the graph, you can see the main steps required to work with an SCPI script.

Creating a SCPI list

With the SCPI record functions, you can create a SCPI command list directly in the instrument and then export the list to the controller. If you want to edit or write a script manually, use a suitable editor on the controller. Even for manually creating, the instrument supports you by showing the corresponding command syntax and the current settings value.

Directly in the instrument, you can create a SCPI list at any time of operation, in the following ways:

- Recording steps
 - Both, automatic and manual SCPI recording of settings is possible. You can start, stop and resume automatic recording, and also record individual commands manually.
 - Manually record the steps selectively
 - In manual recording mode, you can deliberately record a SCPI command with the "Add CPI Command to Recording List" function, see [How to record SCPI lists manually](#).

- Automatically record all performed steps
The instrument records the SCPI command and settings value of each step you perform, and then writes the commands to the file system, see [How to record SCPI lists automatically](#).
You can also add a SCPI command manually to the recording list during automatic SCPI recording.

Note: The vector signal generator clears the SCPI list after booting automatically.

- Generating all settings at once
Generates the SCPI commands of the current instrument settings in one step, and writes the command list in a temporary list, see [How to create a SCPI list with the current instrument settings in one step](#).
Note: This function lists all commands in alphabetical order, in contrast to the recording or manual creation, which consider the order the settings are configured. Using this function can slow down the runtime or cause errors during execution. Therefore, always check and revise a script if necessary, see ["How to check an SCPI list"](#) on page 567.
- Manually create a command script with "Copy" and paste
Enables you to copy the SCPI command and the current setting, see [Chapter 11.11.1, "Show SCPI Command"](#), on page 561.



Some parameters cannot be set by an SCPI command.
If so, *no SCPI command found* is entered instead of a command when you record or generate all settings at once.



The difference between "Show SCPI Command" and the provided cross-reference

If you want to enter your settings in a script, or use a remote control program, you must know the corresponding SCPI command and the exact syntax.

If you need to look up the SCPI command, the instrument offers two ways to figure it out quickly.

- "Show SCPI command" (context-sensitive menu)
Displays the SCPI command syntax of a selected parameter including the current setting value, see [Chapter 11.12, "How to Find Out the SCPI Command Corresponding to the Manual Operation via Show SCPI Command"](#), on page 564. The "Copy" function enables you to write an SCPI script conveniently by hand.
 - Instrument help ([Help] key)
Opens a help topic that describes the selected parameter or instrument function, including a cross-reference to the corresponding SCPI command. The reference leads you to the description of the SCPI command comprising the complete SCPI syntax, all available setting values, value ranges, etc., see [Chapter 11.13, "How to Find Out the SCPI Command Corresponding to the Manual Operation Using the Online Help"](#), on page 564.
-

Creating and exporting a script file

When the script list is completed, a code generator translates the SCPI commands into the source code of a proprietary programming language, using a code template. Therefore, each language requires an appropriate code template. When converted, you can save the script in a file with an extension corresponding to the programming language.

The R&S SMBV100B provides the following predefined code templates by default:

- Plain SCPI
Represents SCPI base format, that is ASCII format, saved as text file (*.txt).
- MATLAB
A programming environment, frequently used in signal processing and test and measurement applications (*.m).
You can directly use this format with MATLAB(c) Toolkit. For comprehensive information on this topic, refer to the application note [1GP60: MATLAB Toolkit for R&S Signal Generators](#).
- NICVI
An ANSI C programming environment designed for measurements and tests (*.c).
You can directly use this format with National Instruments LabWindows CVI.

You can also convert a script to a user-specific format. In this case, you need a code template with the extension *.expcodetmpl.

For information on how to select the code template and save the script in a file, see [Chapter 11.11.3, "SCPI Recording Export Settings"](#), on page 563.

Executing an SCPI script

An SCPI script primarily runs on the controller PC. In addition, you can execute a script directly on the instrument, by assigning the script to the [★ (User)] key.

See [Chapter 10.3.3, "Assigning Actions to the \[★ \(User\)\] Key"](#), on page 500.

11.11.1 Show SCPI Command

Access:

1. Select the parameter.
2. Open the context-sensitive menu (tap and hold).
3. Select "Show SCPI Command".

This function provides the syntax of the remote command with the current setting.

Copy

Copies the command and the current setting.

Close

Exits the "SCPI Command" dialog.

11.11.2 Displaying an SCPI List

The instrument displays a recorded SCPI list and thus provides viewing the recorded results before exporting.

- ▶ Depending on the starting point, you can access the "SCPI Recording List" dialog as follows:
 - During recording
 - Select "Show SCPI Recording List" in the context-sensitive menu.
 - At any time outside recording
 - Select "Show SCPI Recording List" in the context-sensitive menu.
 - This function assumes that at least one recording has been executed after power-on.
 - At the end of the recording
 - Select "Stop automatic SCPI recording". The dialog opens automatically.
 - After you have exported the script to a file.
 - Select "SCPI Recording Export > Show file content"
 - See [Chapter 11.11.3, "SCPI Recording Export Settings"](#), on page 563.

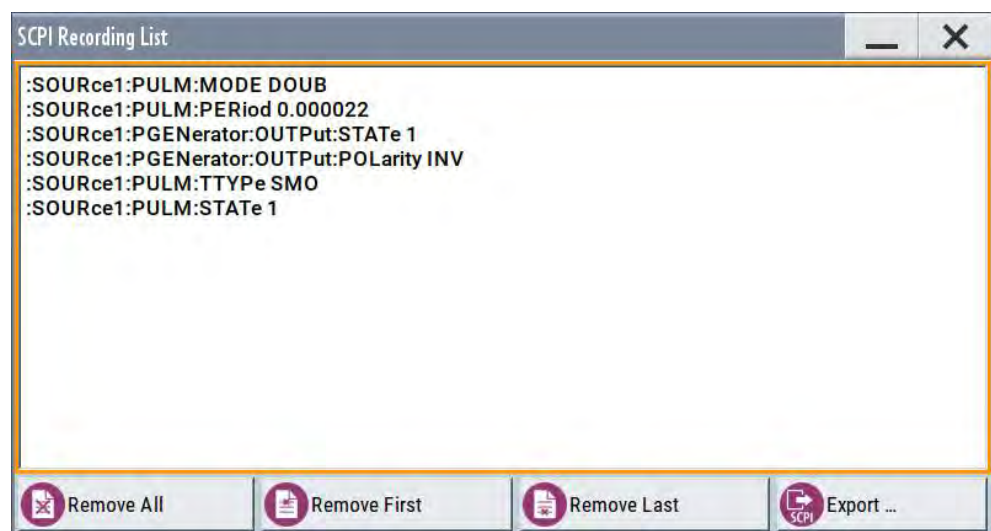

The "SCPI Recording List" shows the last recorded and exported commands.

SCPI Recording List

Lists the automatically or manually recorded recorded SCPI commands.

Export

Opens the [SCPI Recording Export](#) dialog for configuring the file parameters for export.

Remove All, Remove First, Remove Last

Deletes either the first, the last or all recorded SCPI commands.

To remove several recorded commands, repeat the removing.

For post processing, export the SCPI command list in a file, see [Chapter 11.15, "How to Convert and Save SCPI Lists"](#), on page 568.

11.11.3 SCPI Recording Export Settings

Scripts are configured and saved in the "SCPI Recording Export" dialog. This dialog opens automatically, when you stop recording.

Access:

1. Select "Show SCPI Recording List" in the context-sensitive menu.
The "SCPI Recording List" dialog opens.
2. Select "Export".



The "SCPI Recording Export" dialog contains all functions required for export of command lists to a file. It enables you to select the source code format, assign an individual filename and display the file content.

Format

Selects the source code format for the command list.

"Plain SCPI" Uses SCPI syntax.

"Predefined Code Generator"

Accesses the predefined templates for common source code generators that convert the recorded settings in the programming languages MATLAB or NICVI.

"User Code Generator"

Provides the ability to convert a script by a user-specific code generator.

Select Code Template

Opens the standard "File Select" dialog and lists the predefined or user-defined code templates.

See [Chapter 9.5.1, "File Select Settings"](#), on page 458.

File

Opens the standard file select dialog "Select Output File", see [Chapter 9.5.1, "File Select Settings"](#), on page 458.

Export

Executes data export.

The SCPI list is saved in as file with the selected filename and in the selected directory, see [File](#).

Reload

Reloads a SCPI list from a file.

You can export recorded SCPI lists to files (see [File](#) and [Export](#)), that can be modified.

File content

Displays the content of the script in the selected format and code template.

11.12 How to Find Out the SCPI Command Corresponding to the Manual Operation via Show SCPI Command

1. To find out the SCPI command of a parameter in manual operation, select the respective parameter.
2. Open the context-sensitive menu and select "Show SCPI command"



You get the detailed command syntax, including the currently set value.

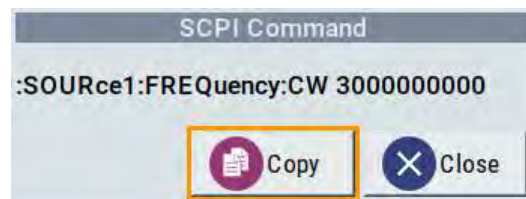

With the "Copy" function, you can conveniently paste the command including the current setting, e.g., in a command script.

11.13 How to Find Out the SCPI Command Corresponding to the Manual Operation Using the Online Help

If you are looking for the remote command to a function in manual operation, you find it in the description of the online help.

1. To find out the SCPI command of a parameter in manual operation, select the respective parameter.
2. To open the corresponding help topic, select one of the following:
 - In the display, select "context-sensitive menu > Help".

 **Help**

- On the front panel, press the [Help] key.

The help topic opens. Apart from the function description, it contains the SCPI command in detailed syntax.

**How to find the corresponding GUI function to a command**

Conversely, if you are looking for a function in the GUI, which belongs to a SCPI, you find it via a cross-reference in the online help and in the user manual.

11.14 How to Record / Create SCPI Lists

How to record SCPI lists automatically

The following example briefly explains how to proceed when you want to record SCPI lists.

For comprehensive information on this topic, refer to the application note [1GP98: SCPI Recorder Test Automation on a Fingertip](#).

1. On the screen, open the context-sensitive menu (touch and hold, or right mouse click) and select "Start SCPI recording".

 **Start SCPI Recording**

Starting from now, all steps you perform are recorded.

2. To stop SCPI recording, select "context-sensitive menu > Stop SCPI recording".

 **Stop SCPI Recording**

The "SCPI Recording List" dialog opens automatically.

3. Proceed with [How to check an SCPI list](#).

How to record SCPI lists manually



We recommend that you activate the "Mark All Parameters Changed from Preset". This function facilitates to track the changes.

1. To retrace your settings, open the context-sensitive menu and select "Mark all Parameters Changed from Preset".

 **Mark All Parameters Changed from Preset**

This function identifies and highlights all settings you have changed, both in the block diagram, and in the dialogs.

Frequency	4.000 000 000 000 GHz	
Offset	10.000 000 kHz	Multiplier 1.000
User Variation		
Variation Active	<input checked="" type="checkbox"/>	Variation Step 1.000 000 000 MHz

2. For selectively recording your steps:
 - a) Set the parameter.
 - b) Open the context-sensitive menu.
 - c) Select "Add SCPI Command to Recording List"

 **Add SCPI Command to Recording List**

Tip: You cannot see "Add SCPI ..." in the menu?

A possible reason is opening the menu outside of a dialog or input field, for example in a block diagram. Open the context-sensitive menu within the corresponding dialog or input field, and the feature is available.

- d) Continue with the next setting, and repeat steps *a to b* whenever needed.

Each time you select "Add SCPI ...", the SCPI command is appended to a temporary list.

3. To check the progress of the recording, select "Context-Sensitive > Show SCPI Recording List".

 **Show SCPI Recording List (4)**

The "SCPI Recording List" dialog opens, displaying all recorded settings so far.

4. Proceed with [How to check an SCPI list](#).

How to create a SCPI list with the current instrument settings in one step

You can also generate a SCPI list from a manually created instrument state at any time, in only one step.

To generate an SCPI list with commands for all settings performed:

1. Select "Save/Recall > SCPI Export".

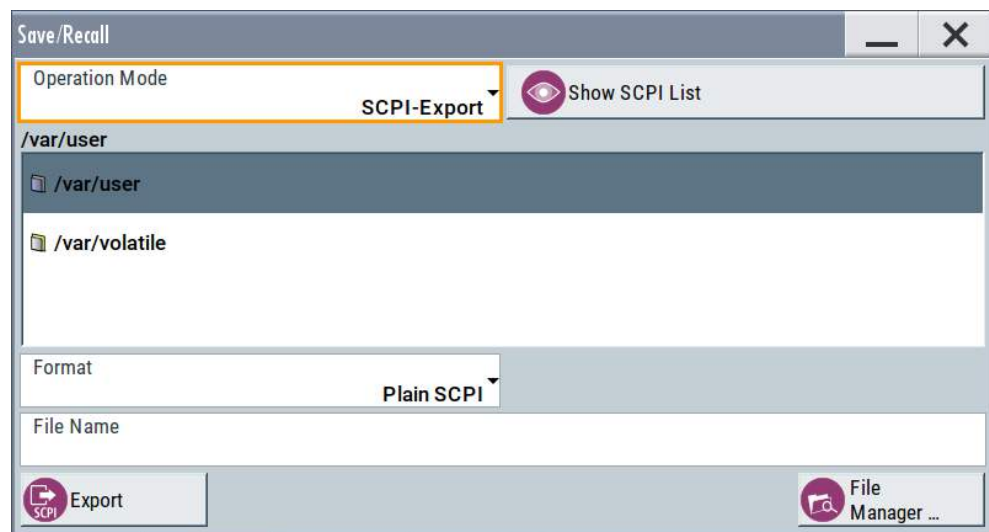

The instrument opens the standard file select dialog, see [Chapter 9.4.1, "Save/Recall Settings"](#), on page 452.

2. In the "Format" entry field, select the source code.
3. Depending on the selected format, convert the script as described in [Chapter 11.15, "How to Convert and Save SCPI Lists"](#), on page 568
4. Enter a filename.
5. Select "Export".
The instrument writes all SCPI commands of the key parameters and the modified settings in the file. Also assigns the file extension automatically according to the source code format.
6. To preview the content of the SCPI list:
 - a) Select "Save/Rcl".
 - b) Select "Operation Mode > SCPI-Export".
 - c) In the `/var/user/` directory, select a previously saved file.
 - d) Select "Show SCPI List".

The list of all SCPI commands is displayed, for example, for a final check.



Exporting the SCPI list of the instrument state in one step is a fast and convenient method. Nevertheless, it usually requires postprocessing on an external PC.

How to check an SCPI list

The easiest way to check a list, is to execute it. The generator returns a warning if a setting could not be performed.

However, we recommend that you check the list and possibly rework. It can be that ...

- A parameter has not assigned an SCPI command or an element of the user interface has not an assigned parameter. In these cases, `:SYST:INF:SCPI 'SCPI command not available'` is entered in the list instead.

Such entries are also detected during execution. The instrument recognizes these incomplete commands and displays an error message.

- A preset has been executed, but several standards subsequently perform some internal settings that are also assigned to the list with "SCPI Export".
- After a preset still some settings are defined, which are then written to the list generated with "SCPI Export."

Some suggestions on how you can check and revise a list:

1. Search and remove missing command entries.
2. Remove unnecessary content written after a preset.
3. Rearrange the commands to a reasonable order. If you, for example, set a `STATe` command to the last position of a list, you can avoid intermediate calculations of the signal.
4. Preview the list for completeness by comparing it with the modified settings in the manual mode.
 - a) To retrace your settings in manual operation, open the context-sensitive menu and select "Mark all parameters changed from preset".
The function identifies all settings you have changed, both in the block diagram, and in the dialogs. They appear orange.
 - b) Check whether there is a command in the list for all modified settings.
5. To perform modifications, export the list to a PC, using for example a USB flash drive.

11.15 How to Convert and Save SCPI Lists

After completing the recording, the "SCPI Recording Export" dialog opens.

1. Select the "Format" for the command syntax in which you want to save the list.
2. "Select Code Template"
Depending on the selected format, proceed accordingly:
Note: Select the code template **before** exporting.
 - a) Plain SCPI
Continue with the next step.
 - b) Predefined code generator
The "SCPI Recording Export - Select Predefined Code Template" dialog opens.
Select one of the predefined code templates.
 - c) User code generator
A file system ("SCPI Recording Export - Select User Code Template") dialog opens.
Select your user-defined code template. The code template must have file extension `*.expcodetmpl`.

3. Select "File..."
The "SCPI Recording Export - Select Output File" dialog opens.
4. Select "New" and assign a filename for saving the recorded list.
5. In the "SCPI Recording Export" dialog, select "Export".
Saves the recorded data either in ASCII format (plain SCPI), or in the corresponding format of the used code template, and shows the SCPI list in the "File Content" section.

11.16 How to Set Up Remote Operation via VNC

This section shows you some examples of the various possibilities to set up remote operation.

- Using a desktop system
 - [Chapter 11.16.1.1, "Using a Web Browser"](#), on page 569
 - [Chapter 11.16.1.2, "Using a VNC Client Software"](#), on page 570
- Using a smart device
 - [Chapter 11.16.2.1, "Using a VNC App"](#), on page 573
 - [Chapter 11.16.2.2, "Using a Web Browser with HTML5"](#), on page 573
 - [Chapter 11.16.2.3, "Special Mode QR Code "](#), on page 574



Enabled direct control

The direct control of the instrument is not disabled and the instrument can be controlled from the front panel and via the remote computer alternately.

11.16.1 Setting Up a Remote Operation from a Desktop System

11.16.1.1 Using a Web Browser

The R&S SMBV100B supports remote operation via VNC with any web browser, like Windows Internet Explorer or Mozilla Firefox for instance, or alternatively, an HTML5 web browser.

To operate the instrument via a web browser remotely:

1. Install the *JRE (Java Runtime Environment)* on the remote computer.
Note: Skip this step if you are working with an HTML5 web browser.
2. Type the instruments' IP address in the address field of the web browser on your PC, e.g. `http://10.113.1.151`
The VNC authentication screen appears.

3. Enter the password and confirm with "OK".
The default password is *instrument*.

After the connection is established, the current screen of the signal generator is displayed and the instrument can be remotely operated from the remote computer.

11.16.1.2 Using a VNC Client Software

A VNC client software is an application which can be used to access and control the instrument from a remote computer through a LAN connection.

The VNC client software for setting up the connection is included in the operating system Linux/Unix per default. For Windows operating systems, a VNC client software must be installed manually.

Various free-of charge programs such as Ultr@VNC or similar VNC client programs are available for download on the Internet.

Setting up the VNC connection on a Linux/Unix desktop client

1. Start a web browser on the remote computer. Enter the IP address of the instrument.
2. Enter the following address:
`vnc://<IP-address of the instrument>`, for example `vnc://10.113.1.151`.
A dialog opens requesting the password for the remote VNC connection.
3. Enter the password and confirm with "OK".
The default password is *instrument*.

After the connection is established, the current screen of the signal generator is displayed and the instrument can be remotely operated from the remote computer.

Setting up the VNC connection on a Windows desktop client

1. Install the VNC viewer program component on the remote computer.
 - a) On the Internet, select a VNC client program and download it onto your PC.
For example the free of charge software Ultr@VNC (`vncviewer.exe` is available, see <http://www.uvnc.com/download/index.html>).
 - b) Execute the VNC client installation.
 - c) Select the VNC viewer program component and follow the installation instructions.
2. Start VNC viewer program component on the PC.

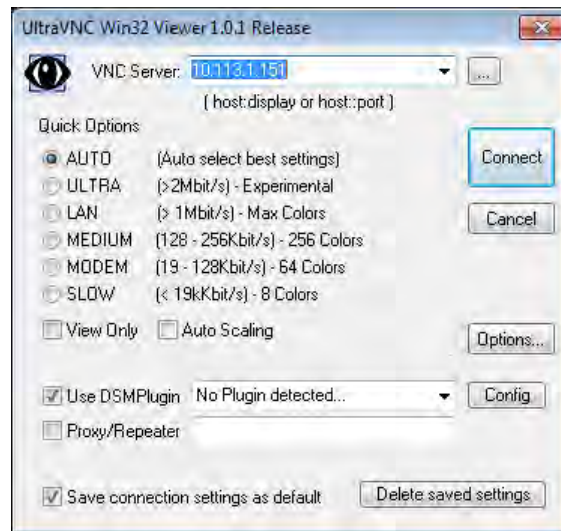

3. Select "VNC Server" and enter the IP address of the instrument.
4. To initialize the connection, select "Connect".

A dialog opens requesting the password.

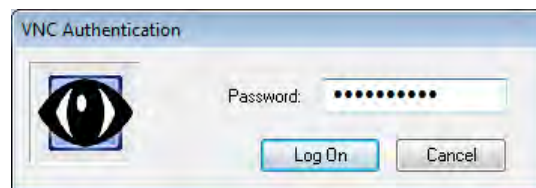

5. Enter the password and confirm with "OK".
The default password is *instrument*.

After the connection is established, the current screen of the signal generator is displayed and the instrument can be remotely operated from the remote computer.

Terminating VNC connection

- ▶ Perform one of the following:
 - a) On an external Unix/Linux PC, close the Internet browser or the signal generator window.
 - b) On an external Windows PC, close the VNC viewer program.

The connection is terminated but not disabled. It can be established again any time.

In the "Active Connections" tab, the displayed TCP/IP connection disappears. Consider, however, the note concerning unauthorized access due to VNC connection ("[Risk of unauthorized access](#)" on page 521).

11.16.2 Setting Up a Remote Operation from a Smart Device

The R&S SMBV100B supports remote operation via VNC from a smart device (remote client), like a tablet (tablet computer) or a smartphone. The smart device accesses the instrument via WLAN, either by a suitable App, or an HTML5 web browser, that means with embedded *javascript*.



There are several possibilities to establish a WLAN connection between the smart device and the R&S SMBV100B, which are, however, not all described here. This section gives an example of how a network environment can be built up, and some essential configuration steps.

For comprehensive information on this topic refer to the application notes:

- [1MA216: Remote Operation of Windows Based Instruments with Apple iPad](#)
- [7BM82: Apple iPad Remote Control of Broadcasting T&M Instruments](#)

Example:

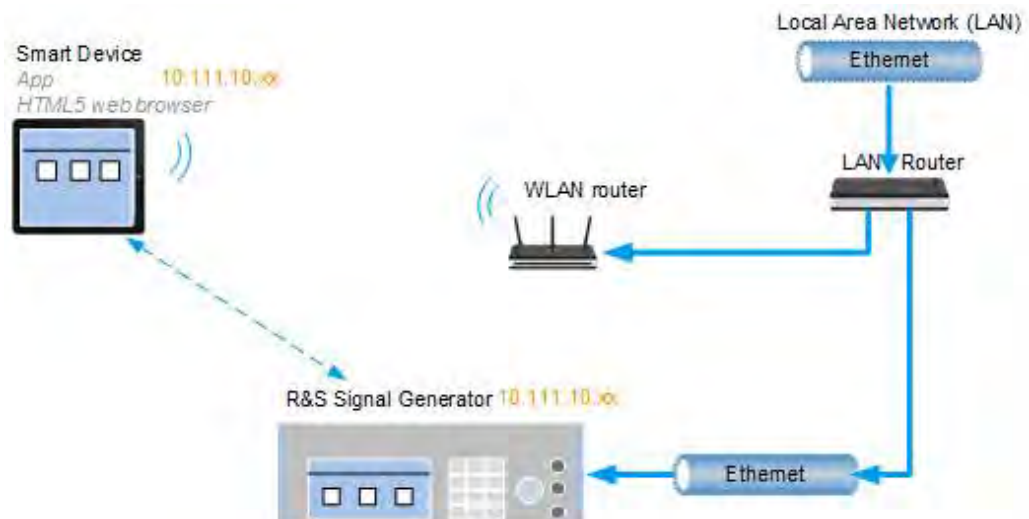

Figure 11-7: Example of a network configuration for remote operation with a smart device

As shown in the figure, the R&S SMBV100B and the WLAN router are connected to the LAN router. The smart device accesses the Rohde & Schwarz instrument via the WLAN router.

Prerequisites

For this network configuration, the following prerequisites must be met:

- The required equipment is:
 - A LAN router
 - A WLAN router (hot spot)
Required for accessing the R&S SMBV100B
- The smart device must be known and accepted in the network of the R&S SMBV100B.

- The *App* or web browser implements the VNC functionality on the smart device for remote operation.

It is recommended that all components in the network use DHCP, which automatically assigns the relevant address information.



With the configuration in the example, you can reach the instrument from a great distance, since the WLAN router acts as an additional access point.

11.16.2.1 Using a VNC App

Using a *VNC App* enables the smart device to access the R&S SMBV100B via WLAN.



The VNC Apps are available from various manufacturers of the smart devices. The list of supported devices is different according to the smart device. Refer to the manufacturer's website to find out whether a VNC App is available for your device, and how it is installed.

1. In the network, establish the connection of the WLAN router to the LAN router. We assume the connection of the LAN router and the R&S SMBV100B and their configuration in the LAN.
2. Configure the WLAN router according to the manufacturer's instructions.
3. Install the required *VNC App* on your smart device.
4. On the smart device, start the *VNC App*.

5. In the address field, enter the IP address of the instrument.

Tip: The R&S SMBV100B indicates IP address on the screen.

A log-on dialog opens and requests the password for the VNC connection.

The default user name and password is *instrument*.

Tip: Default password. Remote access via VNC uses the user name "instrument" with default user password "instrument".

Note: We recommend that you change the default password before connecting the instrument to a network.

See [Chapter 10.5.4, "Password Management"](#), on page 515.

6. Enter the password to establish the remote access.

After the connection is established, the current screen of the signal generator is displayed and the instrument can be remotely operated.

11.16.2.2 Using a Web Browser with HTML5

The R&S SMBV100B supports remote operation from a smart device via VNC with any HTML5 compliant web browser, like Internet Explorer, Firefox, Google Chrome, or Safari for instance.

To operate the instrument remotely via a web browser, proceed as follows:

1. In the web browser enter the IP address of the instrument, e.g. *http://10.113.1.151*.
2. Type the instrument IP address in the address field of the web browser on your PC, e.g. *http://10.113.1.151*

Tip: The R&S SMBV100B indicates IP address on the screen.

The VNC authentication screen appears.

3. Enter the password and confirm with "OK".
The default password is *instrument*.

After the connection is established, the current screen of the signal generator is displayed and the instrument can be remotely operated.

11.16.2.3 Special Mode QR Code

If your smart device is equipped with a camera and a QR code reader, you can scan the instrument's IP address or access the instrument with the Safari web browser.



QR code readers are available from various manufacturers of the smart devices. The list of supported devices is different according to the smart device. Refer to the manufacturer's website to find out whether a reader is available for your device, and how it is installed.

1. Install the required QR code reader software on your device.
2. Start the reader.
3. On the R&S SMBV100B, select "System Config > Remote Access".
4. In the "Remote Access" dialog, select the "QR-Code" tab.
5. Scan the QR code of the instrument with your smart device.
6. On the device, decode the scanned QR code and pass it to the web browser.
A dialog opens requesting the password for the VNC connection.
7. Enter the password and confirm with "OK".
The default password is *instrument*.

After the connection is established, the current screen of the signal generator is displayed and the instrument can be remotely operated.

11.17 References

11.17.1 LXI Functionality

LAN Extensions for Instrumentation (LXI) is an instrumentation platform for measuring instruments and test systems that is based on standard Ethernet technology. LXI is intended to be the LAN-based successor to GPIB, combining the advantages of Ethernet with the simplicity and familiarity of GPIB.

Like GPIB, LXI determines and standardizes the way the instrument behaves in a LAN. The LXI implementation in the R&S SMBV100B allows you to change certain LAN settings, to reset the LAN connection, and to identify the instrument.



For information about the LXI standard, refer to the LXI website at <http://www.lxistandard.org>.

See also "News from Rohde & Schwarz, article 2006/II - 190".

The LXI functionality in the R&S SMBV100B is characterized by a common LAN implementation, including an ICMP ping responder for diagnostics. The instrument can be configured via a web browser. A LAN Configuration Initialize (LCI) mechanism resets the LAN configuration. The instrument also supports automatic detection in a LAN via the VXI-11 discovery protocol and programming by IVI drivers.

In addition the R&S SMBV100B provides the following LXI-related functionality:

- Integrated "LXI Status" dialog for LXI status indication and reset of the LAN configuration, see [Chapter 11.5.1, "LXI Status Settings"](#), on page 541.
- "LXI Browser Interface", as described in [Chapter 11.5.2.1, "LAN Configuration"](#), on page 543.
- "SCPI Remote Trace" utility, see ["SCPI Remote Trace"](#) on page 545.



Firmware update

To enable the full LXI functionality after a firmware update, shut down and restart the instrument.

11.17.2 Code Generator Templates

This section describes the main structure of the code generator templates, and shows the method by means of the NICVI template.

The code generation is controlled by templates with the following blocks:

Command	Function
#EXTENSION_START #EXTENSION_END	Defines the output file extension.
#INIT_CODE_START #INIT_CODE_END	Contains initial entries, such as included files and libraries, buffer size, commands for synchronization, or creating a VISA session. All entries between start and end are written once at the beginning of the output file.
#COMMAND_CODE_START #COMMAND_CODE_END	Frame for an SCPI command. A command is accessed with %COMMAND.
#NO_COMMAND_CODE_START #NO_COMMAND_CODE_END	Frame for a parameter with no SCPI command available. A parameter is accessed with %PARAMETER.
#EXIT_CODE_START #EXIT_CODE_END	Closes the visa session. All entries between start and end are written once at the end of the output file.

Templates are created in ASCII format with file extension *.expcodetempl.

Example:

Example to the code generator template NICVI.expcodetmpl:

```
#EXTENSION_START
.c
#EXTENSION_END

#INIT_CODE_START
#include <ansi_c.h>
#include <visa.h>
#include <cvirte.h>

#define MAX_BUFFER_SIZE 200
static ViStatus status;
static ViSession defaultRM, handle;

static void write_command(char *command)
{
    char writeBuffer[MAX_BUFFER_SIZE];
    char readBuffer[MAX_BUFFER_SIZE];
    int length;
    int readCount;

    strcpy(writeBuffer, command);
    //append "*OPC?" to sync
    strcat(writeBuffer, "*OPC?");
    length = strlen (writeBuffer);
    writeBuffer[length]='\n';
```

```

        length = length+1;
        viWrite (handle, writeBuffer, length, VI_NULL);
        //read result
        viRead(handle, readBuffer, 100, &readCount);
    }
int main (int argc, char *argv[])
{
    if (InitCVIRTE (0, argv, 0) == 0)
        return -1;    /* out of memory */
        //create a VISA session and return a handle to it
        viOpenDefaultRM (&defaultRM);
        //create a VISA session to the serial port and return a handle to it
        viOpen (defaultRM, (ViRsrc)"TCP/IP::localhost::INSTR", VI_NULL, VI_NULL,
&handle);
#INIT_CODE_END

#COMMAND_CODE_START
    write_command("%COMMAND");
#COMMAND_CODE_END

#NO_COMMAND_CODE_START
    //no SCPI command available for parameter %PARAMETER !
#NO_COMMAND_CODE_END

#EXIT_CODE_START
    viClose (handle);
        viClose (defaultRM);
        return 0;
}
#EXIT_CODE_END

```

11.17.3 Remote Control States

How to I recognize if there is an active remote connection to the instrument?

- Observe the indication on the taskbar.





A softkey in the taskbar indicates if and what kind of remote connections are currently set up.

See also [Chapter 11.4.6, "Active Connections Settings"](#), on page 538.

The following table shows the different remote control states and the associated commands or actions to return to manual control.

Table 11-3: Remote control status icons

GUI symbol	Transition to remote control state...	Transition to manual operation...(local state)
	>R (controller) Remote control, but usable front panel keys. The parameters are in read-only mode.	<ul style="list-style-type: none"> • &GTL (controller) • Tap the "Remote" icon (display) • [Local] (front panel or key emulation)
		A currently performed setting is indicated by the green arrows. The setting must be completed (white arrows), otherwise the instrument remains in remote state.
	&LLO (controller) Remote control with locked front panel keys to prevent user interaction. The parameters are in read-only mode. You can unlock LLO, and thus return to manual operation only via remote control.	<ul style="list-style-type: none"> • &LOCS (controller) • CALL IBLOC (generator%) (controller) Note: The command &REMS returns to "Remote" state.

12 Remote Control Commands

In the following, all remote-control commands are presented in detail with their parameters and the ranges of numerical values.

For an introduction to remote control and the status registers, refer to:

- [Chapter 11, "Network Operation and Remote Control"](#), on page 520
- [Chapter A.1, "Additional Basics on Remote Control"](#), on page 946

12.1 Conventions used in SCPI Command Descriptions

Note the following conventions used in the remote command descriptions:

- **Command usage**
If not specified otherwise, commands can be used both for setting and for querying parameters.
If a command can be used for setting or querying only, or if it initiates an event, the usage is stated explicitly.
- **Parameter usage**
If not specified otherwise, a parameter can be used to set a value and it is the result of a query.
Parameters required only for setting are indicated as **Setting parameters**.
Parameters required only to refine a query are indicated as **Query parameters**.
Parameters that are only returned as the result of a query are indicated as **Return values**.
- **Conformity**
Commands that are taken from the SCPI standard are indicated as **SCPI confirmed**. All commands used by the R&S SMBV100B follow the SCPI syntax rules.
- **Asynchronous commands**
A command which does not automatically finish executing before the next command starts executing (overlapping command) is indicated as an **Asynchronous command**.
- **Reset values (*RST)**
Default parameter values that are used directly after resetting the instrument (*RST command) are indicated as ***RST values**, if available.
- **Factory preset values**
Default parameter values that are reset only by factory preset.
- **Default unit**
This is the unit used for numeric values if no other unit is provided with the parameter.
- **Manual operation**
If the result of a remote command can also be achieved in manual operation, a link to the description is inserted.

12.2 Backward Compatibility with Other Rohde & Schwarz Signal Generators

To allow you to use your existing scripts, the R&S SMBV100B accepts also a defined subset of SCPI parameter values of other Rohde & Schwarz signal generators, like the R&S SMBV. The R&S SMBV100B accepts these values and maps them automatically to the corresponding newly introduced parameters.



Handling of parameters provided for backward compatibility with other Rohde & Schwarz signal generators

The parameter values provided for backwards compatibility are "setting only" values; the query commands return the corresponding new value.

Example:

```
SOURce1:BB:ARbitrary:TRIGger:SOURce EXTernal
```

The backwards compatibility parameter value `EXTernal` is accepted

```
SOURce1:BB:ARbitrary:TRIGger:SOURce?
```

Response: `EGT1`

The query returns the correct new value

12.3 Programming Examples

The corresponding sections of the same title provide simple programming examples for the R&S SMBV100B. The purpose of the examples is to present **all** commands for a given task. In real applications, one would rather reduce the examples to an appropriate subset of commands.

The programming examples have been tested with a software tool which provides an environment for the development and execution of remote tests. To keep the examples as simple as possible, only the "clean" SCPI syntax elements are reported. Non-executable command lines (for example comments) start with two `//` characters.

At the beginning of the most remote control program, an instrument (p)reset is recommended to set the R&S SMBV100B to a definite state. The commands `*RST` and `SYSTem:PRESet` are equivalent for this purpose. `*CLS` also resets the status registers and clears the output buffer.

In all the examples we assume that:

- A remote PC is connected to the instrument
- The remote PC and the instrument are switched on
- A connection between them is established
- The security setting "System Config > Setup > Security > SCPI over LAN" is enabled.

12.4 Common Commands

Common commands are described in the IEEE 488.2 (IEC 625-2) standard. These commands have the same effect and are employed in the same way on different devices. The headers of these commands consist of "*" followed by three letters. Many common commands are related to the Status Reporting System.

Available common commands:

*CLS.....	581
*ESE.....	581
*ESR?.....	581
*IDN?.....	582
*IST?.....	582
*OPC.....	582
*OPT?.....	582
*PRE.....	583
*PSC.....	583
*RCL.....	583
*RST.....	583
*SAV.....	584
*SRE.....	584
*STB?.....	584
*TRG.....	584
*TST?.....	585
*WAI.....	585

*CLS

Clear status

Sets the status byte (STB), the standard event register (ESR) and the `EVENT` part of the `QUESTIONABLE` and the `OPERATION` registers to zero. The command does not alter the mask and transition parts of the registers. It clears the output buffer.

Usage: Setting only

*ESE <Value>

Event status enable

Sets the event status enable register to the specified value. The query returns the contents of the event status enable register in decimal form.

Parameters:

<Value> Range: 0 to 255

*ESR?

Event status read

Returns the contents of the event status register in decimal form and subsequently sets the register to zero.

Return values:

<Contents> Range: 0 to 255

Usage: Query only

***IDN?**

Identification

Returns the instrument identification.

Return values:

<ID> "Rohde&Schwarz,<device type>,<part number>/<serial number>,<firmware version>"

Example: Rohde&Schwarz, SMBV100B,
1423.1003K02/102030, 4.30.005

Usage: Query only

Manual operation: See "[IDN String](#)" on page 538

***IST?**

Individual status query

Returns the contents of the IST flag in decimal form. The IST flag is the status bit which is sent during a parallel poll.

Return values:

<ISTflag> 0 | 1

Usage: Query only

***OPC**

Operation complete

Sets bit 0 in the event status register when all preceding commands have been executed. This bit can be used to initiate a service request. The query form writes a "1" into the output buffer as soon as all preceding commands have been executed. This is used for command synchronization.

***OPT?**

Option identification query

Queries the options included in the instrument. For a list of all available options and their description refer to the data sheet.

Return values:

<Options> The query returns a list of options. The options are returned at fixed positions in a comma-separated string. A zero is returned for options that are not installed.

Usage: Query only

Manual operation: See "OPT String" on page 538

***PRE <Value>**

Parallel poll register enable

Sets parallel poll enable register to the indicated value. The query returns the contents of the parallel poll enable register in decimal form.

Parameters:

<Value> Range: 0 to 255

***PSC <Action>**

Power on status clear

Determines whether the contents of the `ENABLE` registers are preserved or reset when the instrument is switched on. Thus a service request can be triggered when the instrument is switched on, if the status registers ESE and SRE are suitably configured. The query reads out the contents of the "power-on-status-clear" flag.

Parameters:

<Action> 0 | 1
0
 The contents of the status registers are preserved.
1
 Resets the status registers.

***RCL <Number>**

Recall

Loads the instrument settings from an intermediate memory identified by the specified number. The instrument settings can be stored to this memory using the command `*SAV` with the associated number.

It also activates the instrument settings which are stored in a file and loaded using the `MMEMory:LOAD <number>, <file_name.extension>` command.

Manual operation: See "Recall Immediate x" on page 455

***RST**

Reset

Sets the instrument to a defined default status. The default settings are indicated in the description of commands.

The command is equivalent to `SYSTem:PRESet`.

Usage: Setting only

Manual operation: See "Preset" on page 447

*SAV <Number>

Save

Stores the current instrument settings under the specified number in an intermediate memory. The settings can be recalled using the command `*RCL` with the associated number.

To transfer the stored instrument settings in a file, use the command `:MMEMory:STORe:STATe`.

Manual operation: See "Save Immediate x" on page 455

*SRE <Contents>

Service request enable

Sets the service request enable register to the indicated value. This command determines under which conditions a service request is triggered.

Parameters:

<Contents> Contents of the service request enable register in decimal form.
Bit 6 (MSS mask bit) is always 0.
Range: 0 to 255

*STB?

Status byte query

Reads the contents of the status byte in decimal form.

Usage: Query only

*TRG

Trigger

Triggers all actions waiting for a trigger event. In particular, `*TRG` generates a manual trigger signal. This common command complements the commands of the `TRIGger` subsystem.

Usage: Event

***TST?**

Self-test query

Initiates self-tests of the instrument and returns an error code

Return values:

<ErrorCode> **integer > 0 (in decimal format)**
 An error occurred.
 (For details see the Service Manual supplied with the instrument).

0
 No errors occurred.

Usage: Query only

***WAI**

Wait to continue

Prevents servicing of the subsequent commands until all preceding commands have been executed and all signals have settled (see also command synchronization and [*OPC](#)).

Usage: Event

12.5 Preset Commands

The preset commands are not bundled in one subsystem. Therefore, they are listed separately in this section.

In addition, a specific preset command is provided for each digital standard. These specific commands are described in the associated subsystems.

Four presetting actions are available:

- Activating the default state of all internal instrument functions ([*RST](#) on page 583). Functions that concern the integration of the instrument into a measurement setup are not changed, e.g. GPIB address or reference oscillator source settings.
- Activating the preset state of the parameters related to the selected signal path ([:SOURce<hw>:PRESet](#) on page 586)
- Activating the preset state of all parameters that are not related to the signal path ([:DEVice:PRESet](#) on page 586)
- Activating the original state of delivery (factory reset, [:SYSTem:FPRreset](#) on page 586). Only functions that are protected by a password remain unchanged as well as the passwords themselves.

:DEVice:PRESet	586
:SOURce<hw>:PRESet	586
:SYSTem:PRESet	586
:SYSTem:FPRreset	586

:DEVIce:PRESet

Presets all parameters which are not related to the signal path, including the LF generator.

Example: DEV:PRESet
Presets all instruments settings that are not related to the signal path.

Usage: Event

Manual operation: See "[Connect/Disconnect All Remote](#)" on page 417

:SOURce<hw>:PRESet

Presets all parameters which are related to the selected signal path.

Example: SOUR:PRESet
Presets all settings that are related to signal path

Usage: Event

:SYSTem:PRESet

Triggers an instrument reset. It has the same effect as:

- The [Preset] key
- The *RST command

For an overview of the settings affected by the preset function, see [Table 9-1](#)

Example: SYST:PRESet
All instrument settings (also the settings that are not currently active) are reset to their default values.

Usage: Setting only

:SYSTem:FPReset

Triggers an instrument reset to the original state of delivery.

Example: SYST:FPReset
All instrument settings (also the settings that are not currently active) are reset to the factory values.

Usage: Event

Manual operation: See "[Execute Factory Preset](#)" on page 448

12.6 MMEMory Subsystem

The `MMEMory` subsystem (Mass MEMory) contains the commands for managing files and directories as well as for loading and storing complete instrument settings in files.

Mass storage location

Without any additional measures, the R&S SMBV100B stores user files on the internal memory, the [removable memory](#), or if connected, on a memory stick.

Both, the user directory `/var/user/` on the internal memory or the `/usb/` directory on the memory stick, can be used to **preserve** user-defined data. Any directory structure can be created.

The `/var/volatile` directory serves as a RAM drive and can be used to protect sensitive information. The data is available **temporarily**.

If option R&S SMBVB-B80 is installed, the R&S SMBV100B maps the user directory to the [removable memory](#). If a memory is mounted, user data is saved there. Otherwise user data is redirected to the volatile memory.

Default storage location

The R&S SMBV100B stores user data in the user directory.

Depending on the installed options, the user directory is physically located on the internal memory or on the [removable memory](#).

In the file system, user directory is always indicated as `/var/user/`.

In manual control, you access this directory via the "File Manager", see [Chapter 9.8, "Using the File Manager"](#), on page 462. In remote control, you can query it with the command `:SYSTEM:MMEMory:PATH:USER?`.

To query and change the default directory used for mass storage, use the command `:MMEMory:CDIRectory`.

12.6.1 File Naming Conventions

To enable files to be used in different file systems, consider the following file naming conventions:

- The *filename* can be of any length and *is case-sensitive*, i.e it is distinguished between uppercase and lowercase letters.
- All letters and numbers are permitted (numbers are, however, not permitted at the beginning of the filename).
- Avoid using special characters.
- Do not use slashes "\" and "/". These symbols are used in file paths.
- Avoid using the following filenames: `CLOCK$, CON, COM1 to COM4, LPT1 to LPT3, NUL or PRN`
They are reserved by the operating system.

File extension

The file and the optional file *extension* are separated by a period sign. The R&S SMBV100B distinguishes the files according to their extensions; each type of file is assigned a specific file content and hence a specific file extension. Refer to [Chapter A.3, "Extensions for User Files"](#), on page 972 for an overview of the supported file extensions.

Wildcards

The two characters "*" and "?" function as "wildcards", i.e. they are used for selecting several files. The "?" character represents exactly one character, while the "*" character represents all characters up to the end of the filename. "*. *" therefore represents all files in a directory.

Filename and file path

When used in remote control commands, the parameter <filename> is specified as a string parameter with quotation marks. It can contain either the complete path including the root user directory /var/user and filename, or only the filename. The filename must include the file extension. The same applies for the directory /var/volatile and for the parameters <directory_name> and <path>.

Depending on how much information is provided, the values specified in the parameter or with the command `MMEM:CDIR` are used for the path and drive setting in the commands.

12.6.2 Accessing Files in the Default or in a Specified Directory

For better overview and easy file handling, you may not save all user files in the user directory /var/user but rather organize them into subdirectories.

The command syntax defines two general ways to access files with user data in a *specific* directory:

- **Change the current default directory** for mass memory storage and then directly access the files in this default directory, like stored list files, files with user data or save/recall files.
(See [Example "Store the user settings in a file in a specific directory"](#) on page 589).
The subsequent commands for file handling (select, delete, read out files in the directory, etc.) require only specification of the filename. File extension can be omitted; after syntax evaluation of the used command, the R&S SMBV100B filters out the relevant files.
- Define the **absolute file path**, including the user directory /var/user, created subdirectories and filename (see [Example "Load file with user data from a specific directory"](#) on page 589).
As a rule, whenever an absolute file path is determined, it overwrites a previously specified default directory.

The following example explains this rule as a principle. Exceptions of this general rule are stated in the description of the corresponding command. The [Chapter 12.6.3, "Pro-](#)

[gramming Examples](#)", on page 590 explains the general working principle with the commands for mass memory storage.

The same rule applies to the `/var/volatile` directory, see [Example "Working with files in the volatile memory"](#) on page 591.

Example: Store the user settings in a file in a specific directory

This example uses the commands for storing and loading files with custom digital modulation settings. Working with the files of other subsystems or files containing the settings of a particular digital standard (e.g. `SOURCE:BB:EUTRa:SETting:...`), is analogical.

We assume that the directory `/var/user/DigMod` is existing and contains the files `SaveRecallTest.dm` and `dmSavRcl.dm`.

```
// Set the default directory first
MMEMory:CDIRectory "/var/user/DigMod"
SOURCE:BB:DM:SETting:CATalog?
// "SaveRecallTest","dmSavRcl"

// Specify only the file name; the extension *.dm is assigned automatically
SOURCE:BB:DM:SETting:STORe "dmSettings"
SOURCE:BB:DM:SETting:DELeTe "dmSavRcl"
SOURCE:BB:DM:SETting:LOAD "SaveRecallTest"
SOURCE:BB:DM:SETting:CATalog?
// "SaveRecallTest","dmSettings"
```

Example: Load file with user data from a specific directory

This example shows how to use the custom digital modulation commands to set the data source and select a data list. Working with other list files, like control lists (`...CLISt:...`) or lists with modulation data (`...MLISt:...`), and the handling of data list files of other subsystems or of a particular digital standard (like `SOURCE:BB:EUTRa:...:DSElect`), is analogical.

We assume that the directory `/var/user/lists` is existing and contains the files `dlist1.dm_iqd` and `myDList.dm_iqd`.

```
// Select a data list file as data source
SOURCE:BB:DM:SOURce DLISt

// Query the data list files (*.dm_iqd) in the default directory
MMEMory:CDIRectory "/var/user/lists"
SOURCE:BB:DM:DLISt:CATalog?
// "dlist1","myDList"

// Specify the complete path to select a data list file (*.dm_iqd)
// in the specific directory
MMEMory:CDIRectory
SOURCE:BB:DM:DLISt:SElect "/var/user/lists/myDList"
SOURCE:BB:DM:DLISt:DELeTe "/var/user/lists/dlist1"
```

12.6.3 Programming Examples

Example: Storing and loading current settings

This example shows two ways of how to store the current instrument setting in the file `settings.savrcltxt` in the directory `/var/user/savrcl`.



Before the instrument settings can be stored in a file, they have to be stored in an intermediate memory using common command `*SAV <number>`. The specified number is then used in the `:MMEMory:STORe:STATe` command.

Also, after loading a file with instrument settings with command `:MMEMory:LOAD:STATe`, these settings have to be activated with the common command `*RCL <number>`.

```
// Store the current settings in an intermediate memory with number 4
*SAV 4

// store the settings in a file in a specific directory;
// the complete path has to be specified
MMEMory:STORe:STATe 4, "/var/user/savrcl/settings.savrcltxt"

// store the settings in a file in the default directory;
// set the default directory; specify only the file name
MMEMory:CDIRectory "/var/user/savrcl"
*SAV 4
MMEMory:STORe:STATe 4, "settings.savrcltxt"

// Load the stored settings in the intermediate memory 4 and activate them
MMEMory:LOAD:STATe 4, "/var/user/settings.savrcltxt"
*RCL 4
```

Example: Working with files and directories

This example shows how to list files in a directory, list the subdirectories, query the number of files in a directory, create directory, rename and delete files.

```
// Query the current default directory for mass storage,
// change the directory to the default user directory "/var/user"
// and read out the files in it
MMEMory:CDIRectory?
// "/var/user/temp"
MMEMory:CDIRectory
MMEMory:CDIRectory?
// "/var/user/"
MMEMory:CATalog?
// 1282630,8102817792,".,DIR,4096","..,DIR,4096","Log,DIR,4096",
// "settings.savrcltxt,BIN,16949","temp,DIR,4096","test,DIR,4096",
// "list.lsw,BIN,1245201"
// the directory "/var/user" contains the predefined directory "Log",
```

```

// the subdirectories "test" and "temp"
// as well as the files "settings.savrc.txt" and "list.lst"

// query only the subdirectories of the current or specified directory
MMEemory:DCATalog? "/var/user"
// ".", "..", "Log", "temp", "test"

// query only number of subdirectories in the current or specified directory
MMEemory:DCATalog:LENGth? "/var/user"
// 5

// query number of files in the current or specified directory
MMEemory:CATalog:LENGth? "/var/user"
// 7

// Create a new directory for mass memory storage in the specified directory
MMEemory:MDIRectory "/var/user/new"

// Copy the file "settings.savrc.txt" into the new directory
MMEemory:COpy "/var/user/settings.savrc.txt", "/var/user/new/settings.savrc.txt"

// Rename the file "settings.savrc.txt" into the new directory
// and read out the files in this specific directory
MMEemory:CDIRectory "/var/user/new"
MMEemory:MOve "settings.savrc.txt", "settings_new.savrc.txt"
MMEemory:CATalog? "/var/user/new"
// 25141,8102789120, ".", DIR, 4096", ".., DIR, 4096", "settings_new.savrc.txt, BIN, 16949"

// Delete the "test" directory
MMEemory:RDIRectory "/var/user/test"

```

Example: Working with files in the volatile memory

This example shows how to work with files in the `/var/volatile` directory.

```

// Change the default directory for mass storage,
// read out the files, load and play a file with the ARB
MMEemory:CDIRectory "/var/volatile"
MMEemory:CDIRectory?
// "/var/volatile"
MMEemory:CATalog?
//13928,525352960, ".", DIR, 60", ".., DIR, 4096", "list.lst, BIN, 9772"

:SOURce1:LIST:SElect "/var/volatile/list"
:SOURce1:FREquency:MODE LIST
:OUTPut1:STATe 1

```

12.6.4 Remote Control Commands

:MMEMory:CATalog?	592
:MMEMory:CATalog:LENGth?	592
:MMEMory:CDIRectory	593
:MMEMory:COpy	593
:MMEMory:DATA	594
:MMEMory:DATA:UNPRotected	594
:MMEMory:DCATalog?	596
:MMEMory:DCATalog:LENGth?	596
:MMEMory:DELeTe	597
:MMEMory:LOAD:STATe	597
:MMEMory:MDIRectory	597
:MMEMory:MOVE	597
:MMEMory:MSIS	598
:MMEMory:RDIRectory	598
:MMEMory:STORe:STATe	598
:MEMory:HFRee?	598

:MMEMory:CATalog? <path>

Returns the content of a particular directory.

Query parameters:

<path>	string
--------	--------

String parameter to specify the directory.
If you leave out the path, the command returns the contents of the directory selected with [:MMEMory:CDIRectory](#).
The path may be relative or absolute.

Return values:

<UsedDiskSpace>	Byte size of all files in the directory.
<FreeDiskSpace>	Remaining disk space in bytes.
<FileInfo>	<NameFileN>,<SuffixFileN>,<SizeFileN> List of files, separated by commas
	<NameFileN> Name of the file.
	<SuffixFileN> Type of the file. Possible suffixes are: ASCii, BINary, DIRectory
	<SizeFileN> Size of the file in bytes.

Usage: Query only

Manual operation: See "[Directory, File List and Filename](#)" on page 454

:MMEMory:CATalog:LENGth? <Path>

Returns the number of files in the current or in the specified directory.

Query parameters:

<Path> string
String parameter to specify the directory. If the directory is omitted, the command queries the content of the current directory, queried with `:MMEMory:CDIRectory` command.

Return values:

<FileCount> integer
Number of files.

Usage: Query only

:MMEMory:CDIRectory <Directory>

Changes the default directory for mass memory storage. The directory is used for all subsequent `MMEM` commands if no path is specified with them.

Parameters:

<Directory> <directory_name>
String containing the path to another directory. The path can be relative or absolute.
To change to a higher directory, use two dots '..'.

Usage: SCPI confirmed

Manual operation: See "[Directory, File List and Filename](#)" on page 454

:MMEMory:COPY <SourceFile>[,<DestinationFile>]

Copies an existing file to a new file. Instead of just a file, this command can also be used to copy a complete directory together with all its files.

Setting parameters:

<SourceFile> string
String containing the path and file name of the source file

<DestinationFile> string
String containing the path and name of the target file. The path can be relative or absolute.
If <DestinationFile> is not specified, the <SourceFile> is copied to the current directory, queried with the `:MMEMory:CDIRectory` command.

Note: Existing files with the same name in the destination directory are overwritten without an error message.

Usage: Setting only
SCPI confirmed

Manual operation: See "[Cut, Copy&Paste and Delete](#)" on page 464

:MMEMory:DATA <Filename>, <BinaryBlock>
:MMEMory:DATA? <Filename>

The setting command writes the block data <BinaryBlock> to the file identified by <Filename>.

Tip: Use this command to read/transfer stored instrument settings or waveforms directly from/to the instrument.

Parameters:

<BinaryBlock> #<number><length_entry><data>
 #: Hash sign; always comes first in the binary block
 <number>: the first digit indicates how many digits the subsequent length entry has
 <length_entry>: indicates the number of subsequent bytes
 <data>: binary block data for the specified length.
 For files with a size with more than nine digits (gigabytes), the instrument allows the syntax # (<Length>), where <Length> is the file size in decimal format.

Parameters for setting and query:

<Filename> string
 String parameter to specify the name of the file.

Example: MMEMory:DATA '/var/user/test.txt', #15hallo
 Writes the block data to the file test.txt.
 The digit 1 indicates a length entry of one digit; the digit 5 indicate a length of the binary data (hallo) in bytes.
 MMEMory:DATA? '/var/user/test.txt'
 Sends the data of the file test.txt from the instrument to the controller in the form of a binary block.
 Response: #15hallo

Usage: SCPI confirmed

:MMEMory:DATA:UNPRotected <Msus>, <Data>

The **setting** command sends the I/Q data and the marker data to the file defined with the <Msus> parameter. The required tags are created automatically so that the file content follows the waveform file format.

The **query** reads out the I/Q data part or the marker information of the specified file.

Waveform files can also be created with the command [:SOURce<hw>]:BB:ARBitrary:WAVEform:DATA. In this case, the *complete content* of the waveform file must be specified, i.e. not only the I/Q or marker data but all required tags.

(see [Chapter 12.16.4.4, "Waveform, Data and List Format"](#), on page 750).

Parameters:

<Msus>

<Identifier>:<file name>

Mass Storage Unit Specifier

A string that specifies whether I/Q data (NVWFM) or marker data (NVMKR) is transferred and the file name the data is stored in.

If the file with the specified name does not exist, a file is created. Any existing content in the file is *overwritten*.

Complete file path and file extension can also be specified. If omitted, files are stored in the default directory and the extension *.wav is assigned to the file name.

Setting parameters:

<Data>

block data

I/Q data or marker binary data, where the number of marker elements has to be equal to the number of I/Q samples

Binary block data follows the syntax:

#<Digits><Length><IQ0..IxQx...IN-1QN-1> or

#<Digits><Length><M0M1...Mx...MN-1>

#

Indicates the start of the binary block

<Digits>

Decimal value

Gives the number of decimal digits used for the <Length> value

<Length>

Decimal value

Number of bytes the follow in the <Binary data> part

IQ0..IxQx...IN-1QN-1

Binary data in ASCII format

IxQx... represents binary data (16-bit signed integer in 2's complement notation) containing the I and Q component alternately and starting with the I component. Each I and Q component consists of 2 bytes in MSB format (most significant byte first). The values of the 2 bytes in an I component and a Q component are in the range: -32768 to +32767.

M0M1...Mx...MN-1

Binary data in ASCII format

Mx represents one marker byte, where only the last 4 bits are used. These 4 bits are assigned to the 4 possible markers of the instrument, 1 bit per marker: Bit₀ = Marker 1, ... Bit₃ = Marker 4. One 4-bit marker element is required for every I/Q sample.

Example:

```
:MMEM:DATA:UNPR "NVWFM:/var/user/wave.wv",#220<IQ00..IxQx>
// the binary data <IQ00..IxQx> is added to a file named wave.wv
// and saved in the selected directory
// <IQ00..IxQx> contains of 20 bytes, i.e. 5 I/Q samples,
// 2 bytes for each I and Q component
// <IQ00..IxQx> is a placeholder;
// the actual ASCII values are not printable

:MMEMory:DATA:UNPRotected? "NVWFM:/var/user/wave.wv"
:MMEMory:DATA:UNPRotected "NVMKR:/var/user/wave.wv",#185*7uuf5*
// the specified marker data is added to a file named wave.wv
// in the specified directory
// used are printable values;
// used are only the last 4 bits of a byte
:MMEMory:DATA:UNPRotected? "NVMKR:/var/user/wave.wv"
// note that, the query returns binary values
SOURcel:BB:ARbitrary:WAVeform:CLOCK "/var/user/wave.wv",1.1E6
SOURcel:BB:ARbitrary:WAVeform:CLOCK? "/var/user/wave.wv"
```

:MMEMory:DCATalog? <path>

Returns the subdirectories of a particular directory.

Query parameters:

<path> String parameter to specify the directory. If the directory is omitted, the command queries the content of the current directory, queried with **:MMEMory:CDIRectory** command.

Return values:

<Catalog> <file_entry>
Names of the subdirectories separated by colons. The first two strings are related to the parent directory.

Usage: Query only

:MMEMory:DCATalog:LENGth? [<Path>]

Returns the number of subdirectories in the current or specified directory.

Query parameters:

<Path> String parameter to specify the directory. If the directory is omitted, the command queries the contents of the current directory, to be queried with **:MMEMory:CDIRectory** command.

Return values:

<DirectoryCount> integer
Number of parent and subdirectories.

Usage: Query only

:MMEMory:DELeTe <Filename>

Removes a file from the specified directory.

Setting parameters:

<Filename> string
String parameter to specify the name and directory of the file to be removed.

Usage: Event
SCPI confirmed

Manual operation: See "[Cut, Copy&Paste and Delete](#)" on page 464

:MMEMory:LOAD:STATe <SavRclStateNumb>, <file_name>

Loads the specified file stored under the specified name in an internal memory.

After the file has been loaded, the instrument setting must be activated using an *RCL command.

Setting parameters:

<SavRclStateNumb> Determines to the specific <number> to be used with the *RCL command, e.g. *RCL 4.

<file_name> String parameter to specify the file name with extension *.savrcltxt.

Usage: Setting only

Manual operation: See "[Recall](#)" on page 455

:MMEMory:MDIRectory <Directory>

Creates a subdirectory for mass memory storage in the specified directory. If no directory is specified, a subdirectory is created in the default directory. This command can also be used to create a directory tree.

Setting parameters:

<Directory> string
String parameter to specify the new directory.

Usage: Event

Manual operation: See "[Create New Directory](#)" on page 464

:MMEMory:MOVE <SourceFile>, <DestinationFile>

Moves an existing file to a new location or, if no path is specified, renames an existing file.

Setting parameters:

<SourceFile> string
String parameter to specify the name of the file to be moved.

<DestinationFile> string
String parameters to specify the name of the new file.

Usage: Event
SCPI confirmed

Manual operation: See "[Rename](#)" on page 464

:MMEMory:MSIS <Msis>

Defines the drive or network resource (in the case of networks) for instruments with windows operating system, using `msis` (MSIS = Mass Storage Identification String).

Note: Instruments with Linux operating system ignore this command, since Linux does not use drive letter assignment.

Usage: SCPI confirmed

:MMEMory:RDIRectory <Directory>

Removes an existing directory from the mass memory storage system. If no directory is specified, the subdirectory with the specified name is deleted in the default directory.

Setting parameters:

<Directory> string
String parameter to specify the directory to be deleted.

Usage: Event

:MMEMory:STORE:STATe <savrcl_state_nr>, <file_name>

Stores the current instrument setting in the specified file.

The instrument setting must first be stored in an internal memory with the same number using the common command `*SAV`.

Setting parameters:

<savrcl_state_nr> Corresponds to the specific <number> defined with the `*SAV` command, e.g. `*SAV 4`.

<file_name> String parameter to specify the file name with extension `*.savrcltxt`.

Usage: Event

Manual operation: See "[Save](#)" on page 455

:MEMory:HFRee?

Returns the used and available memory in Kb.

Return values:

<TotalPhysMemKb>	integer	Total physical memory.
<ApplicMemKb>	integer	Application memory.
<HeapUsedKb>	integer	Used heap memory.
<HeapAvailableKb>	integer	Available heap memory.

Usage: Query only

12.7 CALibration Subsystem

The CALibration subsystem contains the commands needed for performing internal adjustments. This procedure is triggered by the query commands.

Suffix <hw>

Suffix	Value range	Description
CALibration<hw>	[1]	Optional suffix

Understanding the query response

- 0: error-free execution of the adjustments
- 1: indicates that an error occurred; the process has been canceled

:CALibration:ALL[:MEASure]?	599
:CALibration<hw>:ALL:DATE?	600
:CALibration<hw>:ALL:INformation?	600
:CALibration<hw>:ALL:TEMP?	600
:CALibration<hw>:ALL:TIME?	601
:CALibration:DATA:FACTory:DATE?	601
:CALibration:ROSCillator[:DATA]	601
:CALibration<hw>:IQModulator:FULL?	602
:CALibration<hw>:IQModulator:LOCal?	602
:CALibration<hw>:LEVel:ALCTable[:MEASure]?	602

:CALibration:ALL[:MEASure]?? [<Force>]

Starts all internal adjustments that do not need external measuring equipment.

Query parameters:

<Force> string

Return values:

<Measure> 0 | 1 | OFF | ON

Example:

```
CAL:ALL:MEAS?
// "0"
// Executes the adjustments of all instrument functions.
// When completed, it indicates that the adjustment
// has been performed successfully.
```

Usage: Query only

Manual operation: See "[Adjust All](#)" on page 927

:CALibration<hw>:ALL:DATE?

Queries the date of the most recently executed full adjustment.

Suffix:

<hw>	[1]
	Optional suffix

Return values:

<Date>	string
--------	--------

Example:

```
CAL:ALL:DATE?
// "2016-01-01"
```

Usage: Query only

Manual operation: See "[Last Full Adjustment](#)" on page 928

:CALibration<hw>:ALL:INFormation?

Queries the current state of the internal adjustment.

Return values:

<CallInfoText>	string
----------------	--------

Example:

```
CAL:ALL:INF?
// "Instrument is calibrated, no adjustment required."
// "UNCAL, instrument is warming up."
// "UNCAL, Please perform full adjustment after warming up."
// "UNCAL, Please perform full adjustment."
```

Usage: Query only

Manual operation: See "[Information](#)" on page 928

:CALibration<hw>:ALL:TEMP?

Queries the temperature deviation compared to the calibration temperature.

Suffix:

<hw>	[1]
	Optional suffix

Return values:

<Temperature>	string
---------------	--------

Example: `CALibration:ALL:TEMP?`
`// "+39.00 K"`

Usage: Query only

Manual operation: See ["Temperature Offset Since Last Full Adjustment"](#) on page 928

:CALibration<hw>:ALL:TIME?

Queries the time elapsed since the last full adjustment.

Return values:

<Time> string

Example: `CAL:ALL:TIME?`
`// "22 days"`

Usage: Query only

Manual operation: See ["Time Since Last Full Adjustment"](#) on page 928

:CALibration:DATA:FACTory:DATE?

Queries the date of the last factory calibration.

Return values:

<Date> string

Example: `CAL:DATA:FACT:DATE?`
`// "2016-01-01"`

Usage: Query only

Manual operation: See ["Last Factory Calibration"](#) on page 935

:CALibration:ROSCillator[:DATA] <Data>

Sets a user-defined calibration value for the internal reference frequency.

Parameters:

<Data> integer

0 = the factory value is used (i.e. user-defined calibration is disabled)

Value > 0: positive calibration values are used

Value < 0: negative calibration values are used

Range: depends on other values

*RST: 0

Example: See `[[:SOURce]:ROSCillator[:INTernal]:ADJust[:STATe]` on page 874.

:CALibration<hw>:IQModulator:FULL?

Queries the result of the IQ modulator calibration over the entire frequency range.

Return values:

<Full> 0 | 1 | OFF | ON
*RST: 0

Example:

```
CALibration:IQModulator:FULL?
// 0
// Adjustments are performed successfully
```

Usage: Query only

:CALibration<hw>:IQModulator:LOCal?

Starts adjustment of the I/Q modulator for the currently set frequency and baseband gain. The I/Q modulator is adjusted with respect to carrier leakage, I/Q imbalance and quadrature.

Return values:

<Local> 0 | 1 | OFF | ON
*RST: 0

Example:

```
// Start adjustment for the I/Q modulator
// for the currently set frequency
CALibration:IQModulator:LOCal?
// 0
// Adjustments are performed successfully
```

Usage: Query only

Manual operation: See "[Adjust I/Q Modulator Current Frequency](#)" on page 253

:CALibration<hw>:LEVel:ALCTable[:MEASure]?

Performs ALC adjustments according to the predefined values in the ALC table.

Suffix:

<hw> [1]
Optional suffix

Return values:

<Measure> 0 | 1 | OFF | ON

Example:

```
// start adjustments according to the ALC table
CALibration:LEVel:ALCTable:MEASure?
// 0
```

Usage: Query only

12.8 DIAGnostic Subsystem

The `DIAGnostic` subsystem contains the commands used for instrument diagnosis and servicing. SCPI does not define any `DIAGnostic` commands; the commands listed here are all device-specific. All `DIAGnostic` commands are query commands which are not affected by `*RST`.



The test functions are intended for services purposes.

They are thus password-protected functions. Unlock the corresponding protection level to access them, see `:SYSTEM:PROTECT<ch>[:STATE]`

For more information, see R&S SMBV100B Service Manual.

Common suffixes

The following common suffixes are used in remote commands:

Suffix	Value range	Description
<code>DIAGnostic<hw></code>	[1]	Optional suffix

Example: Programming example

The example lists the commands required to query assemblies and test points for diagnosis purposes.

```
// Query the modules available in the instrument
// and variant and revision state of a certain assembly
DIAGnostic1:BGInfo:CATalog?
// IEC_BOARD,BNC_BOARD,BBMB,FPNL,SSYN,SYNEX,RFMB,...
DIAGnostic1:BGInfo? "SSYN"
// SSYN 1412.6667.02 05.02 100000

// Query the test points available in the instrument
// and trigger the measurement in a selected test point
DIAGnostic1:POINt:CATalog?
// ASATT6HP_M5V7,ASATT6HP_OFFSET,...
DIAGnostic1:MEASure:POINt? "BBB_CODER_BBB_US"
// -1.000000V/°C
```

<code>:DIAGnostic<hw>:BGInfo:CATalog?</code>	603
<code>:DIAGnostic<hw>:BGInfo?</code>	604
<code>:DIAGnostic<hw>:POINt:CATalog?</code>	604
<code>:DIAGnostic<hw>[:MEASure]:POINt?</code>	605

`:DIAGnostic<hw>:BGInfo:CATalog?`

Queries the names of the assemblies available in the instrument.

Return values:

<Catalog> string
List of all assemblies; the values are separated by commas
The length of the list is variable and depends on the instrument equipment configuration.

Example: See [Example "Programming example"](#) on page 603.

Usage: Query only

:DIAGnostic<hw>:BGInfo? [<Board>]

Queries information on the modules available in the instrument, using the variant and revision state.

Query parameters:

<Board> string
Module name, as queried with the command :
[DIAGnostic<hw>:BGInfo:CATalog?](#).
To retrieve a complete list of all modules, omit the parameter.
The length of the list is variable and depends on the instrument equipment configuration.

Return values:

<BgInfo> <Module name> <Module stock number incl. variant> <Module revision> <Module serial number>
List of comma-separated entries, one entry per module.
Each entry for one module consists of four parts that are separated by space characters.

Example: See [Example "Programming example"](#) on page 603.

Usage: Query only

Manual operation: See ["Assembly"](#) on page 935

:DIAGnostic<hw>:POINT:CATalog?

Queries the test points available in the instrument.

For more information, see R&S SMBV100B Service Manual.

Return values:

<Catalog> string
List of comma-separated values, each representing a test point

Example: See [Example "Programming example"](#) on page 603.

Usage: Query only

:DIAGnostic<hw>[:MEASure]:POINT? <Name>

Triggers the voltage measurement at the specified test point and returns the measured voltage.

For more information, see R&S SMBV100B Service Manual.

Query parameters:

<Name> <test point identifier>
 Test point name, as queried with the command :
[DIAGnostic<hw>:POINT:CATalog?](#)

Return values:

<Value> <value><unit>

Example: See [Example "Programming example"](#) on page 603.

Usage: Query only

12.9 DISPlay Subsystem

The DISPlay system contains the commands to set the power-save mode of the instrument.

Programming Examples

Example: Activating screen saver mode and display update

Use the following commands to switch on the screen saver of your instrument or to automatic display. These settings are particularly useful when you control the instrument remotely.

```
// Set the wait time interval and activate the screen saver
:DISPlay:PSAVe:HOLDoff 10
:DISPlay:PSAVe:STATe ON

// Disable the display of the current frequency and level values in remote control
:DISPlay:ANNotation:ALL ON
// :DISPlay:ANNotation:FREQuency ON
// :DISPlay:ANNotation:AMPLitude ON

// Enable automatic update of the display at defined time intervals
:DISPlay:UPDate ON
```

Example: Querying the dialog IDs, opening and closing dialogs

Use the following commands to query the dialog IDs of all currently open dialogs. The dialog ID is a prerequisite for opening and closing dialogs via the remote control.



The dialog ID is also required to define user key actions.

See [Chapter 10.3.3, "Assigning Actions to the \[★ \(User\)\] Key"](#), on page 500.

```
// Query the dialog IDs of all open dialogs
:DISPlay:DIALog:ID?
// CEUltraDLGenSetDlg,_, $A DlgKeyRf_Rosc

// Open and close dialogs via remote control
:DISPlay:DIALog:OPEN "CEUltraDLGenSetDlg,_, $A"
:DISPlay:DIALog:OPEN "DlgKeyRf_Rosc"
:DISPlay:DIALog:CLOSe "DlgKeyRf_Rosc"
:DISPlay:DIALog:CLOSe:ALL

:DISPlay:PSAVe:HOLDoff..... 606
:DISPlay:PSAVe[:STATe]..... 606
:DISPlay:BRIGhtness..... 607
:DISPlay:BUtTon:BRIGhtness..... 607
:DISPlay:UPDate..... 607
:DISPlay:ANNotation:AMPLitude..... 607
:DISPlay:ANNotation:FREQuency..... 608
:DISPlay:ANNotation[:ALL]..... 608
:DISPlay:DIALog:ID?..... 608
:DISPlay:DIALog:OPEN..... 609
:DISPlay:DIALog:CLOSe..... 609
:DISPlay:DIALog:CLOSe:ALL..... 610
```

:DISPlay:PSAVe:HOLDoff <HoldoffTimeMin>

Sets the wait time for the screen saver mode of the display.

Parameters:

<HoldoffTimeMin> integer
 Range: 1 to 60
 *RST: n.a. (factory preset: 10)
 Default unit: minute

Example: see [Example "Activating screen saver mode and display update"](#) on page 605

Manual operation: See ["Wait Time"](#) on page 482

:DISPlay:PSAVe[:STATe] <State>

Activates the screen saver mode of the display.

We recommend that you use this mode to protect the display, if you operate the instrument in remote control.

To define the wait time, use the command `:DISPlay:PSAVe:HOLDoff`.

Parameters:

<State> 0 | 1 | OFF | ON
 *RST: n.a. (factory preset: 0)

Example: See [Example "Activating screen saver mode and display update"](#) on page 605

Manual operation: See ["Screen Saver"](#) on page 482

:DISPlay:BRIGhtness <BRIGhtness>

Sets the brightness of the display.

Parameters:

<BRIGhtness> float
 Range: 1.0 to 20.0
 Increment: 1.0
 *RST: 14.0

Example: `DISPlay:BRIGhtness 14`

Manual operation: See ["Display"](#) on page 482

:DISPlay:BUtTon:BRIGhtness <ButonBrightnes>

Sets the brightness of the [RF on/off] key.

Parameters:

<ButonBrightnes> integer
 Range: 1 to 20
 *RST: n.a. (no preset. default: 14)

Example: `DISPlay:BUtTon:BRIGhtness 15`

Manual operation: See ["RF Hardkey"](#) on page 482

:DISPlay:UPDate <Update>

Activates the refresh mode of the display.

Parameters:

<Update> 0 | 1 | OFF | ON
 *RST: n.a. (factory preset: 1)

Example: See [Example "Activating screen saver mode and display update"](#) on page 605

Manual operation: See ["Display Update is"](#) on page 483

:DISPlay:ANNOtation:AMPLitude <State>

Indicates asterisks instead of the level values in the status bar.

Parameters:

<State> 0 | 1 | OFF | ON
*RST: n.a. (factory preset: 1)

Example: See [Example "Activating screen saver mode and display update"](#) on page 605

Manual operation: See ["Annotation Amplitude"](#) on page 511

:DISPlay:ANNOtation:FREQuency <State>

Indicates asterisks instead of the frequency values in the status bar.

Parameters:

<State> 0 | 1 | OFF | ON
*RST: n.a. (factory preset: 1)

Example: See [Example "Activating screen saver mode and display update"](#) on page 605

Manual operation: See ["Annotation Frequency"](#) on page 511

:DISPlay:ANNOtation[:ALL] <State>

Displays asterisks instead of the level and frequency values in the status bar of the instrument.

We recommend that you use this mode if you operate the instrument in remote control.

Parameters:

<State> 0 | 1 | OFF | ON
*RST: 1

Example: See [Example "Activating screen saver mode and display update"](#) on page 605

:DISPlay:DIALog:ID?

Returns the dialog identifiers of the open dialogs in a string separated by blanks.

Return values:

<DialogIdList> <DialogID#1>< ><DialogID#2>< > ... < ><DialogID#n>

Dialog identifiers are string without blanks. Blanks are represented as \$\$.

Dialog identifiers <DialogID> are composed of two main parts: <DialogName>[<OptionalParts>]

<DialogName>
Meaningful information, mandatory input parameter for the commands:

- :DISPlay:DIALog:OPEN on page 609
- :DISPlay:DIALog:CLOSe on page 609

<Optional parts>
String of \$<X> values, where <X> is a character, interpreted as follows:

- \$q<DialogQualifier>: optional dialog qualifier, usually the letter A or B, as displayed in the dialog title.
- \$i<Instances>: comma-separated list of instance indexes, given in the order h, c, s, d, g, u, 0. Default is zero; the terminating ", 0" can be omitted.
- \$t<TabIds>: comma-separated indexes or tab names; required, if a dialog is composed of several tabs.
- \$x<Left>\$y<Top>\$h<Left>\$w<Top>: position and size; superfluous information.

Example: See [Example "Querying the dialog IDs, opening and closing dialogs"](#) on page 605

Usage: Query only

Manual operation: See ["SCPI"](#) on page 500

:DISPlay:DIALog:OPEN <DialogId>

Opens the specified dialog.

Setting parameters:

<DialogId> string

To find out the dialog identifier, use the query [:DISPlay:DIALog:ID?](#).
The <DialogName> part of the query result is mandatory.

Example: See [Example "Querying the dialog IDs, opening and closing dialogs"](#) on page 605

Usage: Setting only

Manual operation: See ["SCPI"](#) on page 500

:DISPlay:DIALog:CLOSe <DialogId>

Closes the specified dialog.

Setting parameters:

<DialogId> string
 To find out the dialog identifier, use the query `:DISPlay:DIALog:ID?`.
 The <DialogName> part of the query result is sufficient.

Example: See [Example "Querying the dialog IDs, opening and closing dialogs"](#) on page 605

Usage: Setting only

:DISPlay:DIALog:CLOSe:ALL

Closes all open dialogs.

Example: See [Example "Querying the dialog IDs, opening and closing dialogs"](#) on page 605

Usage: Event

12.10 FORMat Subsystem

The commands in the FORMat subsystem determine the format of data returned by the R&S SMBV100B to the controller. This affects all query commands that return a list of numerical data or block data, noted in the descriptions of the commands. The set data format applies to both paths.

<code>:FORMat:BORDER</code>	610
<code>:FORMat:SREGister</code>	611
<code>:FORMat[DATA]</code>	611

:FORMat:BORDER <Border>

Determines the sequence of bytes within a binary block. This only affects blocks which use the IEEE754 format internally.

Parameters:

<Border> NORMal | SWAPped

NORMal
 Expects/sends the *least* significant byte of each IEEE754 floating-point number first and the *most* significant byte last.

SWAPped
 Expects/sends the *most* significant byte of each IEEE754 floating-point number first and the *least* significant byte last.

*RST: NORMal

Example: `FORM:BORD SWAP`
 transfers the data with the most significant bit first.

:FORMat:SREGister <Format>

Determines the numeric format for responses of the status register.

Parameters:

<Format> ASCII | BINary | HEXadecimal | OCTal

ASCII

Returns the register content as a decimal number.

BINary|HEXadecimal|OCTal

Returns the register content either as a binary, hexadecimal or octal number. According to the selected format, the number starts with #B (binary), #H (hexadecimal) or #O (octal).

*RST: ASCII

Example:

FORM:SREG HEX

returns the register content as a hexadecimal number.

:FORMat[:DATA] <Data>

Determines the data format the instrument uses to return data via the IEC/IEEE bus.

The instrument automatically detects the data format used by the controller, and assigns it accordingly. Data format determined by this SCPI command is in this case irrelevant.

Parameters:

<Data> ASCII | PACKed

ASCII

Transfers numerical data as plain text separated by commas.

PACKed

Transfers numerical data as binary block data.

The format within the binary data depends on the command.

The various binary data formats are explained in the description of the parameter types.

*RST: ASCII

Example:

FORM ASC

transfers the data as ASCII data.

12.11 HCOPI Subsystem

The HCOPI subsystem contains the commands to generate and save a hard copy of the display.



To access a stored hard copy file, use the commands of the MEMM subsystem.

Example: Store a hard copy of the display

The following example lists commands to configure and execute a hard copy to an automatic named file.

```
:HCOPY:DEVIce:LANGUage PNG
:HCOPY:FILE:NAME:AUTO:STATE 1
// defines the output format
// sets the instrument to automatically create output file names

// *****
// Configure hard copy options, set automatic naming rules
// An automatically generated file name consists of:
// <Prefix><YYYY><MM><DD><Number>.<Format>
// *****
:HCOPY:DEVIce:LANGUage BMP
// defines output format *.bmp
:HCOPY:REGIon DIALog
// selects the region to be copied
:HCOPY:FILE:AUTO:DIR "/usb/HCopy"
// sets destination directory of automatic named file
:HCOPY:FILE:NAME:AUTO:FILE:PREFIx:STATE 1
:HCOPY:FILE:NAME:AUTO:FILE:PREFIx:"hardcopy"
:HCOPY:FILE:NAME:AUTO:FILE:YEAR:STATE 1
:HCOPY:FILE:NAME:AUTO:FILE:MONTH:STATE 1
// uses automatic naming prefix
// sets automatic naming prefix to "hardcopy"
// uses automatic naming date parameters year and month

// *****
// Execute and transfer the hard copy
// *****
:HCOPY:EXECute
:HCOPY:DATA
// generates a hard copy
// transfers the hard copy to the remote client
:HCOPY:FILE:AUTO:FILE?
// queries the automatic file name
// "hardcopy1607001.bmp"
:HCOPY:FILE:AUTO:NUMBer?
// queries the number in the automatic file name
// "001"
:HCOPY:FILE:AUTO?
// queries the path and file name of the automatically generated file
// "/usb/HCopy/hardcopy1607001.bmp"
```

12.11.1 Hard Copy Settings

With the following commands, you can configure the settings of a hard copy.

:HCOPY:DATA?.....	613
:HCOPY:IMAGe:FORMat.....	613
:HCOPY:DEVIce:LANGUage.....	613
:HCOPY:REGion.....	613
:HCOPY:FILE[:NAME].....	613
:HCOPY[:EXECute].....	614

:HCOPY:DATA?

Transfers the hard copy data directly as a NByte stream to the remote client.

Return values:

<Data> block data

Example: See [Example "Store a hard copy of the display"](#) on page 612

Usage: Query only

:HCOPY:IMAGe:FORMat <Format>

:HCOPY:DEVIce:LANGUage <Language>

Selects the graphic format for the hard copy. You can use both commands alternatively.

Parameters:

<Language> BMP | JPG | XPM | PNG

*RST: PNG

Example: See [Example "Store a hard copy of the display"](#) on page 612

Manual operation: See ["Format"](#) on page 476

:HCOPY:REGion <Region>

Selects the area to be copied.

You can create a snapshot of the screen or an active dialog.

Parameters:

<Region> ALL | DIALog

*RST: ALL

Example: See [Example "Store a hard copy of the display"](#) on page 612

Manual operation: See ["Region"](#) on page 476

:HCOPY:FILE[:NAME] <Name>

Determines the file name and path to save the hard copy, provided automatic naming is disabled.

Note: If you have enabled automatic naming, the instrument automatically generates the file name and directory, see [Chapter 12.11.2, "Automatic Naming"](#), on page 614.

Parameters:

<Name> string

Example: See [Example "Store a hard copy of the display"](#) on page 612

Manual operation: See ["File..."](#) on page 475

:HCOPY[:EXECute]

Generates a hard copy of the current display. The output destination is a file.

Example: See [Example "Store a hard copy of the display"](#) on page 612

Usage: Event

Manual operation: See ["Save"](#) on page 476

12.11.2 Automatic Naming

Use the following commands to automatically assign a file name.

:HCOPY:FILE[:NAME]:AUTO?	614
:HCOPY:FILE[:NAME]:AUTO:DIRectory	614
:HCOPY:FILE[:NAME]:AUTO:DIRectory:CLear	615
:HCOPY:FILE[:NAME]:AUTO:FILE?	615
:HCOPY:FILE[:NAME]:AUTO:STATe	615
:HCOPY:FILE[:NAME]:AUTO[:FILE]:DAY:STATe	615
:HCOPY:FILE[:NAME]:AUTO[:FILE]:MONTH:STATe	615
:HCOPY:FILE[:NAME]:AUTO[:FILE]:YEAR:STATe	615
:HCOPY:FILE[:NAME]:AUTO[:FILE]:NUMBer?	616
:HCOPY:FILE[:NAME]:AUTO[:FILE]:PREFix	616
:HCOPY:FILE[:NAME]:AUTO[:FILE]:PREFix:STATe	616

:HCOPY:FILE[:NAME]:AUTO?

Queries path and file name of the hardcopy file, if you have enabled *Automatic Naming*.

Return values:

<Auto> string

Example: See [Example "Store a hard copy of the display"](#) on page 612

Usage: Query only

:HCOPY:FILE[:NAME]:AUTO:DIRectory <Directory>

Determines the path to save the hard copy, if you have enabled *Automatic Naming*.

If the directory does not yet exist, the instrument automatically creates a new directory, using the instrument name and `/var/user/` by default.

Parameters:

<Directory> string
 *RST: /var/user/

Example: See [Example "Store a hard copy of the display"](#) on page 612

Manual operation: See ["Path..."](#) on page 477

:HCOPY:FILE[:NAME]:AUTO:DIRectory:CLEar

Deletes all files with extensions *.bmp, *.jpg, *.png and *.xpm in the directory set for automatic naming.

Example: See [Example "Store a hard copy of the display"](#) on page 612

Usage: Event

Manual operation: See ["Clear Path"](#) on page 477

:HCOPY:FILE[:NAME]:AUTO:FILE?

Queries the name of the automatically named hard copy file.

An automatically generated file name consists of:

<Prefix><YYYY><MM><DD><Number>.<Format>.

You can activate each component separately, to individually design the file name.

Return values:

<File> string

Example: See [Example "Store a hard copy of the display"](#) on page 612.

Usage: Query only

:HCOPY:FILE[:NAME]:AUTO:STATe <State>

Activates automatic naming of the hard copy files.

Parameters:

<State> 0 | 1 | OFF | ON
 *RST: 1

Example: See [Example "Store a hard copy of the display"](#) on page 612

Manual operation: See ["Automatic Naming"](#) on page 475

:HCOPY:FILE[:NAME]:AUTO[:FILE]:DAY:STATe <State>**:HCOPY:FILE[:NAME]:AUTO[:FILE]:MONTH:STATe <State>****:HCOPY:FILE[:NAME]:AUTO[:FILE]:YEAR:STATe <State>**

Uses the date parameters (year, month or day) for the automatic naming. You can activate each of the date parameters separately.

Parameters:

<State> 0 | 1 | OFF | ON
 *RST: 1

Example: See [Example "Store a hard copy of the display"](#) on page 612

Manual operation: See ["Prefix, Year, Month, Day"](#) on page 477

:HCOPY:FILE[:NAME]:AUTO[:FILE]:NUMBER?

Queries the number that is used as part of the file name for the next hard copy in automatic mode.

At the beginning, the count starts at 0. The R&S SMBV100B searches the specified output directory for the highest number in the stored files. It increases this number by one to achieve a unique name for the new file.

The resulting auto number is appended to the resulting file name with at least three digits.

Return values:

<Number> integer
 Range: 0 to 999999
 *RST: 0

Example: See [Example "Store a hard copy of the display"](#) on page 612

Usage: Query only

Manual operation: See ["Current Auto Number"](#) on page 478

:HCOPY:FILE[:NAME]:AUTO[:FILE]:PREFIX <Prefix>**:HCOPY:FILE[:NAME]:AUTO[:FILE]:PREFIX:STATE <State>**

Uses the prefix for the automatic generation of the file name, provided `PREF:STAT` is activated.

Parameters:

<State> 0 | 1 | OFF | ON
 *RST: 1

Example: See [Example "Store a hard copy of the display"](#) on page 612

Manual operation: See ["Prefix, Year, Month, Day"](#) on page 477

12.12 KBOard Subsystem

The KBOard subsystem contains the commands to set a connected keyboard.

[:KBOard:LAYout](#).....617

:KBOard:LAYout <Layout>

Selects the language for an external keyboard and assigns the keys accordingly.

Parameters:

<Layout> CHINese | DANish | DUTCh | DUTBe | ENGLish | ENGUK |
FINNish | FRENch | FREBe | FRECa | GERMan | ITALian |
JAPAnese | KORean | NORWegian | PORTuguese | RUSSian |
SPANish | SWEDish | ENGUS
*RST: n.a. (factory preset: ENGLish)

Example:

```
:KBOard:LAYout US
// activates American keyboard
```

Manual operation: See "[USB Keyboard > Layout](#)" on page 483

12.13 OUTPut Subsystem

In the OUTPut subsystem, you can configure the output signals.

The LF output signal is defined with the commands of the [Chapter 12.16.10, "SOURce:LFOutput Subsystem"](#), on page 829 system.

Common suffixes

The following common suffixes are used in remote commands:

Suffix	Value range	Description
OUTPut<hw>	[1]	Optional suffix

:OUTPut:ALL[:STATe].....	617
:OUTPut<hw>[:STATe].....	618
:OUTPut<hw>[:STATe]:PON.....	618
:OUTPut<hw>:AMODe.....	618
:OUTPut<hw>:IMPedance?.....	618
:OUTPut<hw>:AFIXed:RANGe:LOWer?.....	619
:OUTPut<hw>:AFIXed:RANGe:UPPer?.....	619
:OUTPut<hw>:PROTection:CLEar.....	619
:OUTPut<hw>:PROTection:TRIPped?.....	619

:OUTPut:ALL[:STATe] <State>

Activates the RF output signal of the instrument.

Parameters:

<State> 0 | 1 | OFF | ON
*RST: n.a. (factory preset: 0)

Example:

```
OUTPut:ALL:STATe 0
```

:OUTPut<hw>[:STATe] <State>

Activates the RF output signal.

Parameters:

<State> 0 | 1 | OFF | ON
*RST: 0

Example: OUTP ON
 Activates the RF output.

Manual operation: See "[RF State/RF ON](#)" on page 262

:OUTPut<hw>[:STATe]:PON <Pon>

Defines the state of the RF output signal when the instrument is switched on.

Parameters:

<Pon> OFF | UNCHanged
*RST: n.a. (factory preset: UNCHanged)

Example: OUTP:PON OFF
 The RF output is deactivated when the instrument is switched on.

Manual operation: See "[Power-On State](#)" on page 484

:OUTPut<hw>:AMODe <AMode>

Sets the attenuator mode at the RF output.

Parameters:

<AMode> AUTO | FIXEd

AUTO

The attenuator adjusts the level settings automatically, within the full variation range.

FIXEd

The attenuator and amplifier stages are fixed at the current position, providing level settings settings with constant output VSWR. The resulting variation range is calculated according to the position.

*RST: AUTO

Example: SOURce:POWer:ALC:STATe 1
 OUTPut:AMODe FIXEd

Manual operation: See "[Mode](#)" on page 347

:OUTPut<hw>:IMPedance?

Queries the impedance of the RF outputs.

Return values:

<Impedance> G1K | G50 | G10K
*RST: G50

Example:

OUTP:IMP?
queries the impedance of RF output.
Response: 50
the impedance is 50 ohms

Usage:

Query only

Manual operation: See "[RF output impedance](#)" on page 262

:OUTPut<hw>:AFIXed:RANGe:LOWer?**:OUTPut<hw>:AFIXed:RANGe:UPPer?**

Queries the settable minimum/maximum value in mode :OUTPut:AMODE FIXed, i.e. when the attenuator is not being adjusted.

See :OUTPut<hw>:AMODE on page 618

Return values:

<Upper> float
Increment: 0.01
Default unit: dBm

Example:

```
OUTPut1:AMODE FIXed
OUTPut1:AFIXed:RANGe:UPPer?
// -27
OUTPut1:AFIXed:RANGe:LOW?
// -50
```

Usage:

Query only

Manual operation: See "[Level Range](#)" on page 348

:OUTPut<hw>:PROTection:CLEar

Resets the protective circuit after it has been tripped.

To define the output state, use the command :OUTPut<hw>[:STATE].

Example:

OUTP:PROT:CLE
Resets the protective circuit of the RF output.

Usage:

Event

Manual operation: See "[Overload](#)" on page 348

:OUTPut<hw>:PROTection:TRIPped?

Queries the state of the protective circuit.

Return values:

<Tripped> 0 | 1 | OFF | ON
 *RST: 0

Example:

OUTP:PROT:TRIP
 queries the state of the protective circuit of the RF output.
 Response: 0
 the protective circuit has not tripped.

Usage:

Query only

Manual operation: See "Overload" on page 348

12.14 SENSE, READ, INITiate and SLISt Subsystems

These subsystems contain the commands for configuring the power measurements with R&S NRP power sensor connected to the R&S SMBV100B.



The local state is set with the `INIT` command. Switching off the local state enhances the measurement performance. Measurements results can be retrieved in local state on or off.

Sensor parameters are set with the `SENSe` commands.

To start the measurement and retrieve the result, use the `:READ<ch>[:POWER]` command.

Suffix	Value range	Description
SENSe<ch>	[1] to 4	Indicates the sensor Sensor mapping: <ul style="list-style-type: none"> • <code>SENSe[1]</code> - default mapping for sensors connected to the [Sensor] connector • <code>SENSe2</code> - sensor connected to a [USB] connector • <code>SENSe3 4</code> - further connected sensors to [USB] connectors, in the connection order Use the <code>:SLISt</code> commands to change the sensor mapping
READ<ch>	[1] to 4	Sensor assignment
INIate<hw>	[1] to 4	Sensor assignment
ELEMent<ch>	[1] to 25	Sensor mapping list

Programming examples

Example: Detecting and assigning a power sensor

```
SLISt:LIST?
// Response: "NRP33SN-V-900007-USB Legacy","NRP-Z211-900001-USB Legacy"
// list of automatically detected sensors

SLISt:SCAN:STATe 1
// searches for sensors connected in the LAN or via the USBTMC protocol

SLISt:LIST?
// Response:
// "NRP33SN-V-900007-USB Legacy","NRP-Z211-900001-USB Legacy",
// "NRP33SN-V-900005-USBTMC","NRP33SN-V-900011-LAN"
// list of automatically detected sensors
// the list can contain more entries

SLISt:ELEMent3:MAPPing SENS1
// maps the third sensor from the list to the first sensor channel

SLISt:SENSor:MAP "NRPS18S-100654-USB Legacy", SENS3
// maps the sensor directly to channel 3
```

Example: Performing a simple power measurement

Prerequisite: The sensor is connected to the instrument and mapped to the first sensor channel.

```
:INITiate1:CONTinuous ON
//Switches the continuous power measurement on

:READ1?
// Triggers the measurement and displays the results
```

Example: Performing a power measurement with a fixed filter

Prerequisite: The sensor is connected to the instrument and mapped to the first sensor channel.

```

SENSe1:SOURce RF
//Sensor measures the power of the RF signal

SENSe1:FILTer:TYPE NSRatio
//Selects fixed noise filter mode

SENSe1:FILTer:NSRatio 0.02 DB
//Sets the maximum noise component in the result to 0.02 DB

SENSe1:FILTer:NSRatio:MTIME 10
//Limits the settling time to 10 seconds.

:SENSe1:APERTure:DEFault:STATe 0
// Deactivates the default aperture time of the sensor

:SENSe1:APERTure:TIME 10e-6
// Sets the aperture time to 10 us

SENSe1:UNIT DBM
//Selects unit dBm for the measured value

:INITiate:CONTinuous ON
//Switches the continous power measurement on

:READ?
//Triggers the measurement and displays the results

```

:SLISt[:LIST]?.....	623
:SLISt:SCAN[:STATe].....	623
:SLISt:ELEMent<ch>:MAPPing.....	623
:SLISt:SENSor:MAP.....	624
:INITiate<hw>[:POWer]:CONTinuous.....	624
:READ<ch>[:POWer]?.....	624
:SENSe<ch>:UNIT[:POWer].....	625
:SENSe<ch>[:POWer]:APERTure:DEFault:STATe.....	625
:SENSe<ch>[:POWer]:APERTure:TIME.....	626
:SENSe<ch>[:POWer]:CORRection:SPDevice:SElect.....	626
:SENSe<ch>[:POWer]:CORRection:SPDevice:STATe.....	626
:SENSe<ch>[:POWer]:CORRection:SPDevice:LIST?.....	627
:SENSe<ch>[:POWer]:DISPlay:PERMANent:PRlority.....	627
:SENSe<ch>[:POWer]:DISPlay:PERMANent:STATe.....	627
:SENSe<ch>[:POWer]:FILTer:LENGth:AUTO?.....	627
:SENSe<ch>[:POWer]:FILTer:LENGth[:USER].....	628
:SENSe<ch>[:POWer]:FILTer:NSRatio.....	628
:SENSe<ch>[:POWer]:FILTer:NSRatio:MTIME.....	629
:SENSe<ch>[:POWer]:FILTer:SONCe.....	629

:SENSe<ch>[:POWer]:FILTer:TYPE.....	629
:SENSe<ch>[:POWer]:FREQUency.....	630
:SENSe<ch>[:POWer]:LOGGing:STATe.....	630
:SENSe<ch>[:POWer]:OFFSet.....	631
:SENSe<ch>[:POWer]:OFFSet:STATe.....	631
:SENSe<ch>[:POWer]:SNUMber?.....	631
:SENSe<ch>[:POWer]:SOURce.....	632
:SENSe<ch>[:POWer]:STATus[:DEVice]?.....	632
:SENSe<ch>[:POWer]:SVERsion?.....	632
:SENSe<ch>[:POWer]:TYPE?.....	632
:SENSe<ch>[:POWer]:ZERO.....	633

:SLISt[:LIST]?

Returns a list of all detected sensors in a comma-separated string.

Return values:

<SensorList> String of comma-separated entries
 Each entry contains information on the sensor type, serial number and interface.
 The order of the entries does not correspond to the order the sensors are displayed in the "NRP Sensor Mapping" dialog.

Example: See [Example "Detecting and assigning a power sensor"](#) on page 621.

Usage: Query only

Manual operation: See "[Sensor Mapping List](#)" on page 366

:SLISt:SCAN[:STATe] <State>

Starts the search for R&S NRP power sensors, connected in the LAN or via the USBTMC protocol.

Parameters:

<State> 0 | 1 | OFF | ON
 *RST: 0

Example: See [Example "Detecting and assigning a power sensor"](#) on page 621.

Manual operation: See "[Scan](#)" on page 366

:SLISt:ELEMent<ch>:MAPPING <Mapping>

Assigns an entry from the [:SLISt\[:LIST\]?](#) to one of the four sensor channels.

Parameters:

<Mapping> SENS1 | SENSor1 | SENS2 | SENSor2 | SENS3 | SENSor3 | SENS4 | SENSor4 | UNMapped

Sensor channel.

*RST: UNMapped

Example:

See [Example "Detecting and assigning a power sensor"](#) on page 621.

Manual operation: See "[Sensor Mapping List](#)" on page 366

:SLISt:SENSor:MAP <SensorId>, <Mapping>

Assigns a sensor directly to one of the sensor channels, using the sensor name and serial number.

To find out the the sensor name and ID, you can get it from the label of the R&S NRP, or using the command `:SLISt:SCAN[:STATe]`. This command detects all R&S NRP power sensors connected in the LAN or via 'USBTMC' protocol.

Setting parameters:

<SensorId> string

<Mapping> enum

Example:

See [Example "Detecting and assigning a power sensor"](#) on page 621.

Usage:

Setting only

Manual operation: See "[Sensor Mapping List](#)" on page 366

:INITiate<hw>[:POWER]:CONTInuous <Continuous>

Switches the local state of the continuous power measurement by R&S NRP power sensors on and off. Switching off local state enhances the measurement performance during remote control.

The remote measurement is triggered with `:READ<ch>[:POWER]?`. This command also returns the measurement results. The local state is not affected, measurement results can be retrieved with local state on or off.

Parameters:

<Continuous> 0 | 1 | OFF | ON

*RST: 0

Example:

INIT1:CONT ON

Switches local state of continuous power measurement on.

Manual operation: See "[State](#)" on page 370

:READ<ch>[:POWER]?

Triggers power measurement and displays the results.

Note: This command does not affect the local state, i.e. you can get results with local state on or off. For long measurement times, we recommend that you use an SRQ for command synchronization (MAV bit).

Suffix:

<ch> 1 to 3

Return values:

<Power> float or float,float

The sensor returns the result in the unit set with command :

[SENSe<ch>:UNIT\[:POWer\]](#)

Certain power sensors, such as the R&S NRP-Z81, return two values, first the value of the average level and - separated by a comma - the peak value.

Example:

```
SENS1:UNIT DBM
// Selects unit dBm for presentation of measurement result
READ1?
// Queries the measurement result of the sensor
// -45.6246576745440230
// -45.6 dBm were measured at the given frequency
```

Example:

```
R&S NRP-Z81
READ1?
-55.62403263352178,-22.419472478812476
-55.6 dBm is the measured average level, -22.4 dBm is the measured peak
```

Usage:

Query only

Manual operation: See "[Level \(Peak\) / Level \(Average\)](#)" on page 370

:SENSe<ch>:UNIT[:POWer] <Power>

Selects the unit (Watt, dBm or dBµV) of measurement result display, queried with :
[READ<ch>\[:POWer\]?](#).

Parameters:

<Power> DBM | DBUV | WATT
*RST: DBM

Example:

```
SENS2:UNIT DBM
Selects dBm as unit for the measured value returned by com-
mand READ.
READ2?
Response: 7.34
7.34 dBm are measured by sensor 2.
```

Manual operation: See "[Level \(Peak\) / Level \(Average\)](#)" on page 370

:SENSe<ch>[:POWer]:APERTure:DEFault:STATe <UseDefAp>

Deactivates the default aperture time of the respective sensor.

To specify a user-defined value, use the command `:SENSe<ch>[:POWer]:APERTure:TIME` on page 626.

Parameters:

<UseDefAp> 0 | 1 | OFF | ON
*RST: 1

Example: See [Example "Performing a power measurement with a fixed filter"](#) on page 622.

Manual operation: See ["Default Aperture Time"](#) on page 373

`:SENSe<ch>[:POWer]:APERTure:TIME <ApTime>`

Defines the aperture time (size of the acquisition interval) for the corresponding sensor.

Parameters:

<ApTime> float
Range: depends on connected power sensor
Increment: 1E-9
*RST: depends on connected power sensor

Example: See [Example "Performing a power measurement with a fixed filter"](#) on page 622.

Manual operation: See ["Aperture Time"](#) on page 373

`:SENSe<ch>[:POWer]:CORRection:SPDevice:SElect <Select>`

Several S-parameter tables can be stored in a sensor. The command selects a loaded data set for S-parameter correction for the corresponding sensor.

Parameters:

<Select> float
*RST: 0

Manual operation: See [" S-Parameter "](#) on page 373

`:SENSe<ch>[:POWer]:CORRection:SPDevice:STATe <State>`

Activates the use of the S-parameter correction data.

Note: If you use power sensors with attenuator, the instrument automatically activates the use of S-parameter data.

Parameters:

<State> 0 | 1 | OFF | ON
*RST: 0

Example: `SENSe1:POWer:CORRection:SPDevice:STATe 1`
`// activates the use of the S-parameters correction data`

Manual operation: See [" S-Parameter "](#) on page 373

:SENSe<ch>[:POWer]:CORRection:SPDevice:LIST?

Queries the list of the S-parameter data sets that have been loaded to the power sensor.

Return values:

<List> string list
*RST: 0

Usage: Query only

Manual operation: See " [S-Parameter](#) " on page 373

:SENSe<ch>[:POWer]:DISPlay:PERMANent:PRiority <Priority>

Selects average or peak power for permanent display.

Parameters:

<Priority> AVERAge | PEAK
*RST: AVERAge

Example:

```
SENS1:DISP:PERM:STAT ON
The permanent viewer is switched on.
SENS1:DISP:PERM:PRI AVER
The measured average power is indicated.
```

:SENSe<ch>[:POWer]:DISPlay:PERMANent:STATe <State>

Activates the permanent display of the measured power level results. The instrument also indicates the sensor type, the connection, the measurement source and the offset if set.

Parameters:

<State> 0 | 1 | OFF | ON
*RST: 0

Example:

```
SENS1:POW:DISP:PERM:STAT ON
The permanent viewer is switched on.
```

Manual operation: See " [Permanent](#) " on page 371

:SENSe<ch>[:POWer]:FILTer:LENGTh:AUTO?

Queries the current filter length in filter mode `AUTO` (`:SENSe<ch>[:POWer]:FILTer:TYPE`)

Return values:

<Auto> float
Range: 1 to 65536

Example: SENS1:FILT:TYPE AUTO
Selects auto filter.
SENS1:FILT:LENG:AUTO?
Queries the automatically set filter length.
Response: 1024

Usage: Query only

Manual operation: See ["Filter Length"](#) on page 372

:SENSe<ch>[:POWer]:FILTer:LENGth[:USER] <User>

Selects the filter length for `SENS:POW:FILT:TYPE USER`. As the filter length works as a multiplier for the time window, a constant filter length results in a constant measurement time (see also ["About the measuring principle, averaging filter, filter length, and achieving stable results"](#) on page 367).

The R&S NRP power sensors provide different resolutions for setting the filter length, depending on the used sensor type:

- Resolution = 1 for R&S NRPxx power sensors
- Resolution = 2ⁿ for sensors of the R&S NRP-Zxx family, with n = 1 to 16

Parameters:

<User> float
Range: 1 to 65536
*RST: 1

Example: SENS1:FILT:TYPE USER
// Selects user filter mode
SENS1:FILT:LENG 16
// Sets a filter length of 16.
// E.g. using a sensor with 20 ms time window,
// the resulting measurement time is 640 ms (2x16x20 ms)

Manual operation: See ["Filter Length"](#) on page 372

:SENSe<ch>[:POWer]:FILTer:NSRatio <NSRatio>

Sets an upper limit for the relative noise content in fixed noise filter mode (: `SENSe<ch>[:POWer]:FILTer:TYPE`). This value determines the proportion of intrinsic noise in the measurement results.

Parameters:

<NSRatio> float
Range: 0.001 to 1
Increment: 0.001
*RST: 0.01

Example: See [Example "Performing a power measurement with a fixed filter"](#) on page 622.

Manual operation: See ["Noise/Signal Ratio"](#) on page 372

:SENSe<ch>[:POWer]:FILTer:NSRatio:MTIME <MTime>

Sets an upper limit for the settling time of the auto-averaging filter in the `NSRatio` mode and thus limits the length of the filter. The filter type is set with command `:SENSe<ch>[:POWer]:FILTer:TYPE`.

Parameters:

<MTime>	float
	Range: 1 to 999.99
	Increment: 0.01
	*RST: 4

Example: See [Example "Performing a power measurement with a fixed filter"](#) on page 622.

Manual operation: See ["Timeout"](#) on page 372

:SENSe<ch>[:POWer]:FILTer:SONCe

Starts searching the optimum filter length for the current measurement conditions. You can check the result with command `:SENS1:POW:FILT:LENG:USER?` in filter mode `USER (:SENSe<ch>[:POWer]:FILTer:TYPE)`.

Example:

```
SENS1:FILT:TYPE USER
Selects user filter mode.
SENS1:FILT:SONC
Activates the search for the optimum filter length.
SENS1:FILT:LENG?
Returns the found optimum filter length.
Response: 128
```

Usage: Event

Manual operation: See ["Auto Once"](#) on page 372

:SENSe<ch>[:POWer]:FILTer:TYPE <Type>

Selects the filter mode. The filter length is the multiplier for the time window and thus directly affects the measurement time.

Parameters:

<Type>

AUTO | USER | NSRatio

AUTO

Automatically selects the filter length, depending on the measured value. The higher the power, the shorter the filter length, and vice versa.

USER

Allows you to set the filter length manually. As the filter-length takes effect as a multiplier of the measurement time, you can achieve constant measurement times.

NSRatio

Selects the filter length (averaging factor) according to the criterion that the intrinsic noise of the sensor (2 standard deviations) does not exceed the specified noise content. You can define the noise content with command `:SENSe<ch>[:POWer]:FILTer:NSRatio`.

Note: To avoid long settling times when the power is low, you can limit the averaging factor limited with the "timeout" parameter (`:SENSe<ch>[:POWer]:FILTer:NSRatio:MTIME`).

*RST: AUTO

Example:

See [Example "Performing a power measurement with a fixed filter"](#) on page 622.

Manual operation:

See ["Filter"](#) on page 371

:SENSe<ch>[:POWer]:FREQUency <Frequency>

Sets the RF frequency of the signal, if signal source "USER" is selected (`:SENSe<ch>[:POWer]:SOURce`).

Parameters:

<Frequency>

float

*RST: 1 GHz

Example:

`SENS1:SOUR USER`

Selects user-defined source.

`SENS1:FREQ 2.44GHz`

Sets the RF frequency of the source which is 2.44 GHz.

Manual operation:

See ["Frequency"](#) on page 371

:SENSe<ch>[:POWer]:LOGGing:STATe <State>

Activates the recording of the power values, measured by a connected R&S NRP power sensor.

Parameters:

<State>

0 | 1 | OFF | ON

*RST: 0

Example: `SENS:LOGG:STAT ON`
 Activates recording of the power measurement of the first sensor.

Manual operation: See ["Enable Logging"](#) on page 373

:SENSe<ch>[:POWer]:OFFSet <Offset>

Sets a level offset which is added to the measured level value after activation with command `:SENSe<ch>[:POWer]:OFFSet:STATe`. The level offset allows, e.g. to consider an attenuator in the signal path.

Parameters:

<Offset> float
 Range: -100.0 to 100.0
 *RST: 0
 Default unit: dB

Example: `SENS1:POW:OFFS 10.0`
 Sets a level offset of 10 dB

Manual operation: See ["Level Offset State,Level Offset"](#) on page 371

:SENSe<ch>[:POWer]:OFFSet:STATe <State>

Activates the addition of the level offset to the measured value. The level offset value is set with command `:SENSe<ch>[:POWer]:OFFSet`.

Parameters:

<State> 0 | 1 | OFF | ON
 *RST: 0

Example: `SENS1:POW:OFFS 0.4dB`
 Sets a level offset of 0.4 dB
`SENS1:POW:OFFS:STAT ON`
 A level offset of 0.4 dB is added to the measured value.

Manual operation: See ["Level Offset State,Level Offset"](#) on page 371

:SENSe<ch>[:POWer]:SNUMber?

Queries the serial number of the sensor.

Return values:

<SNumber> string

Example: `SENS1:SNUM?`
 Queries the serial number.

Usage: Query only

Manual operation: See ["Sensor type and serial number"](#) on page 370

:SENSe<ch>[:POWer]:SOURce <Source>

Determines the signal to be measured.

Note: When measuring the RF signal, the sensor considers the corresponding correction factor at that frequency, and uses the level setting of the instrument as reference level.

Parameters:

<Source> A | USER | RF
*RST: A

Example: See [Example "Performing a power measurement with a fixed filter"](#) on page 622.

Manual operation: See "[Use Frequency Of](#)" on page 371

:SENSe<ch>[:POWer]:STATus[:DEVice]?

Queries if a sensor is connected to the instrument.

Return values:

<Status> 0 | 1 | OFF | ON
*RST: 0

Example: SENS1:STAT?
Response: 1
A sensor is connected.

Usage: Query only

Manual operation: See "[State](#)" on page 370

:SENSe<ch>[:POWer]:SVERsion?

Queries the software version of the connected R&S NRP power sensor.

Return values:

<SVersion> string

Example: SENS1:POW:SVER?
Queries the software version of the power sensor.

Usage: Query only

:SENSe<ch>[:POWer]:TYPE?

Queries the sensor type. The type is automatically detected.

Return values:

<Type> string

- Example:** SENS1:TYPE?
Queries the type of sensor.
Response: NRP-Z21
The R&S NRP-Z21 sensor is used.
- Usage:** Query only
- Manual operation:** See "[Sensor type and serial number](#)" on page 370

:SENSe<ch>[:POWer]:ZERO

Performs zeroing of the sensor.

Zeroing is required after warm-up, i.e. after connecting the sensor.

Note: Switch off or disconnect the RF power source from the sensor before zeroing.

We recommend that you zero in regular intervals (at least once a day), if:

- The temperature has varied more than about 5 °C.
- The sensor has been replaced.
- You want to measure very low power.

Example: SENS1:ZERO
Executes zeroing.

Usage: Event

Manual operation: See "[Zero](#)" on page 370

12.15 SCONfiguration Subsystem

The SCONfiguration subsystem contains the commands for defining the system configuration setting, like stream mapping and used baseband configuration.

Required options

See "[Required options](#)" on page 413.

Example: Distributing the I/Q streams to the output connectors

The following example lists the commands necessary to fulfill this task.

```
// *****
// Map the I/Q streams to the output connectors
// *****
SCONfiguration:OUTPut:MAPPING:RF1:STReam1:STATe ON
SCONfiguration:OUTPut:MAPPING:IQOutput1:STReam3:STATe ON
```

Example: Connecting and configuring external instrument

The following example lists the commands necessary to fulfill this task.

```

SCONfiguration:EXTErnal:DISPlay ALL
SCONfiguration:EXTErnal:REMOte:CLEan
SCONfiguration:EXTErnal:REMOte:SCAN
SCONfiguration:EXTErnal:REMOte:SCAN:STATE?
// 0

SCONfiguration:EXTErnal:IQOutput:DIRection?
// SCONfiguration:EXTErnal:DIGital:IQConnection:STATE?

SCONfiguration:EXTErnal:REMOte:LIST?
// Response: SMBV100A,SGS_2,SGT100A,SMBV_1
SCONfiguration:EXTErnal:REMOte:ADD "SGS_1","USB","100007"
SCONfiguration:EXTErnal:REMOte:ADD "SGT100A","LAN","10.112.11.125","1"
SCONfiguration:EXTErnal:REMOte:LIST?

SCONfiguration:EXTErnal:REMOte:REName "SGS_2","SGS (102030)"
SCONfiguration:EXTErnal:REMOte:LIST?
// Response:
// SMBV100A,SGS (102030),SGT100A,SMBV_1

// Detecting a connected external instrument and connecting it
// SCONfiguration:EXTErnal:DIGital:REMOte:DETECT?
// Response: "SMBV100A"

SCONfiguration:EXTErnal:IQOutput:REMOte:ISElect?
// Response: "SGT100A","A"
SCONfiguration:EXTErnal:IQOutput:REMOte:CONNECT

// Manually defining the externa instrument
SCONfiguration:EXTErnal:IQOutput:REMOte:ISElect "SGS_1","A"
SCONfiguration:EXTErnal:IQOutput:REMOte:CONNECT

SCONfiguration:EXTErnal:IQOutput:INAME?
// Response: "SGS_1 [A]"

// Use an user defined initialization file
// MMEMory:CDIRECTory "/var/user/RcExtInstr"
// SCONfiguration:EXTErnal:REMOte:INITIALIZation:USER:CATalog?
// Response: init_seq_sgs
// SCONfiguration:EXTErnal:IQOutput:REMOte:INITIALIZation:USER:FILE "init_seq_sgs.iec"

SCONfiguration:EXTErnal:ACONnect 1
*RST

SCONfiguration:EXTErnal:REMOte:PURGe
// Disabling remote control of the external instruments
SCONfiguration:EXTErnal:REMOte:DISConnect[:ALL]

```

Example: Configuring master-slave mode

```
// in the first (master) instrument
SOURCE1:ROSCillator:SOURCE INT
SCONfiguration:MULTIinstrument:MODE MAST
SCONfiguration:MULTIinstrument:STATE 1
SCONfiguration:APPLY

// in the second (slave) instrument
SOURCE1:ROSCillator:SOURCE EXT
SOURCE1:ROSCillator:EXTERNAL:FREQUENCY 10MHZ
SCONfiguration:MULTIinstrument:MODE SLAV
SCONfiguration:MULTIinstrument:STATE 1

SOURCE1:INPUT:USER5:DIRection INP
SOURCE1:INPUT:USER4:SIGNal OUTSinc
SOURCE1:INPUT:USER5:DIRection OUTP
OUTPut1:USER5:SIGNal INSinc
SCONfiguration:MULTIinstrument:TRIGger:SYNChronization?
// SYNC
```

- [Multi Instrument Configuration](#)..... 635
- [I/Q Stream Mapping](#)..... 636
- [External RF and I/Q Instruments](#)..... 636

12.15.1 Multi Instrument Configuration

Commands:

```
:SCONfiguration:MULTIinstrument:MODE..... 635
:SCONfiguration:MULTIinstrument:STATE..... 635
:SCONfiguration:MULTIinstrument:TRIGger:SYNChronization?..... 636
```

:SCONfiguration:MULTIinstrument:MODE <MSMode>

Sets if the instrument works as master or as slave.

Parameters:

```
<MSMode>          SLAVe | MASTer
                  *RST:    MASTer
```

Example: See [Example "Configuring master-slave mode"](#) on page 635.

Manual operation: See ["Multi Instrument Trigger"](#) on page 401

:SCONfiguration:MULTIinstrument:STATE <TriggerState>

Activates the selected mode.

Parameters:

```
<TriggerState>    0 | 1 | OFF | ON
                  *RST:    0
```

Example: See [Example "Configuring master-slave mode"](#) on page 635.

Manual operation: See ["State"](#) on page 400

:SCONfiguration:MULTIinstrument:TRIGger:SYNChronization?

Queries if synchronization is achieved.

Return values:

<SyncState> SYNC | NOSync
*RST: NOSync

Example: See [Example "Configuring master-slave mode"](#) on page 635.

Usage: Query only

Manual operation: See ["Synchronisation State"](#) on page 401

12.15.2 I/Q Stream Mapping

Commands:

:SCONfiguration:OUTPut:MAPPing:RF:STReam<st>:STATe..... 636
:SCONfiguration:OUTPut:MAPPing:IQOutput:STReam<st>:STATe..... 636

:SCONfiguration:OUTPut:MAPPing:RF:STReam<st>:STATe <State>
:SCONfiguration:OUTPut:MAPPing:IQOutput:STReam<st>:STATe <State>

Maps the I/Q output streams to the output connectors.

Parameters:

<State> 0 | 1 | OFF | ON
*RST: 0

Example: See [Example "Distributing the I/Q streams to the output connectors"](#) on page 633.

Manual operation: See ["Map Stream X to Connector"](#) on page 414

12.15.3 External RF and I/Q Instruments

:SCONfiguration:EXTernal:DISPlay..... 637
:SCONfiguration:EXTernal:ACONnect..... 637
:SCONfiguration:EXTernal:REMOte:CONNect[:ALL]..... 638
:SCONfiguration:EXTernal:REMOte:DISConnect[:ALL]..... 638
:SCONfiguration:EXTernal:PBEHaviour..... 638
:SCONfiguration:EXTernal:DIGital:DIRection?..... 639
:SCONfiguration:EXTernal:IQOutput:DIRection?..... 639
:SCONfiguration:EXTernal:DIGital:IQConnection:STATe?..... 639
:SCONfiguration:EXTernal:DIGital:RCONnection:STATe?..... 640
:SCONfiguration:EXTernal:IQOutput:RCONnection:STATe?..... 640
:SCONfiguration:EXTernal:DIGital:INAMe?..... 640

:SCONfiguration:EXternal:IQOutput:INAME?.....	640
:SCONfiguration:EXternal:DIgital:RF:COUPling.....	640
:SCONfiguration:EXternal:IQOutput:RF:COUPling.....	640
:SCONfiguration:EXternal:DIgital:RF:FREQUency.....	641
:SCONfiguration:EXternal:IQOutput:RF:FREQUency.....	641
:SCONfiguration:EXternal:DIgital:RF:FREQUency:OFFSet.....	641
:SCONfiguration:EXternal:IQOutput:RF:FREQUency:OFFSet.....	641
:SCONfiguration:EXternal:DIgital:RF:POWer.....	641
:SCONfiguration:EXternal:IQOutput:RF:POWer.....	641
:SCONfiguration:EXternal:DIgital:RF:POWer:OFFSet.....	642
:SCONfiguration:EXternal:IQOutput:RF:POWer:OFFSet.....	642
:SCONfiguration:EXternal:DIgital:RF:STATe.....	642
:SCONfiguration:EXternal:IQOutput:RF:STATe.....	642
:SCONfiguration:EXternal:REMOte:SCAN.....	643
:SCONfiguration:EXternal:REMOte:SCAN:STATe?.....	643
:SCONfiguration:EXternal:REMOte:LIST?.....	643
:SCONfiguration:EXternal:REMOte:ADD.....	643
:SCONfiguration:EXternal:REMOte:REName.....	644
:SCONfiguration:EXternal:DIgital:REMOte:DETEct?.....	644
:SCONfiguration:EXternal:DIgital:REMOte:ISELect.....	645
:SCONfiguration:EXternal:IQOutput:REMOte:ISELect.....	645
:SCONfiguration:EXternal:DIgital:REMOte:CONNEct.....	645
:SCONfiguration:EXternal:IQOutput:REMOte:CONNEct.....	645
:SCONfiguration:EXternal:DIgital:REMOte:INFO?.....	645
:SCONfiguration:EXternal:IQOutput:REMOte:INFO?.....	645
:SCONfiguration:EXternal:DIgital:REMOte:DISCONNEct.....	646
:SCONfiguration:EXternal:IQOutput:REMOte:DISCONNEct.....	646
:SCONfiguration:EXternal:REMOte:INItialization:USER:CATalog?.....	646
:SCONfiguration:EXternal:DIgital:REMOte:INItialization:FILE.....	646
:SCONfiguration:EXternal:IQOutput:REMOte:INItialization:FILE.....	646
:SCONfiguration:EXternal:REMOte:PURGe.....	646
:SCONfiguration:EXternal:REMOte:CLEan.....	647

:SCONfiguration:EXternal:DISPlay <DisplayMode>

Filters the displayed connectors upon the selected criteria.

Parameters:

<DisplayMode> ALL | MAPPed | INPut | OUTPut
*RST: MAPPed

Example: See [Example "Connecting and configuring external instrument"](#) on page 633.

Manual operation: See ["Display"](#) on page 416

:SCONfiguration:EXternal:ACONnect <State>

Enables automatic detection and connection setup of connected external instruments.

Parameters:

<State> 0 | 1 | OFF | ON
*RST: 0

Example:

See [Example "Distributing the I/Q streams to the output connectors"](#) on page 633.

Manual operation: See ["Auto Connect"](#) on page 416

:SCONfiguration:EXTernal:REMote:CONNect[:ALL]

:SCONfiguration:EXTernal:REMote:DISConnect[:ALL]

Triggers the instrument to establish the connections to all configured external RF and I/Q instruments or to disconnect all existing connections.

Example:

See [Example "Connecting and configuring external instrument"](#) on page 633.

Usage:

Event

Manual operation: See ["Connect/Disconnect All Remote"](#) on page 417

:SCONfiguration:EXTernal:PBEHaviour <State>

If enabled, the connection to the external instruments is retained on instrument's preset (*RST).

Parameters:

<State> 0 | 1 | OFF | ON
*RST: n.a. (factory preset: 0)

Example:

```

SCONfiguration:EXTErnal:IQOutput1:RCONnection:STATE?
// 1
SOURce:FREQuency:CW?
// 60000000000
SOURcel:IQ:OUTPup:ANALog:TYPE DIFFerential

SCONfiguration:EXTErnal:PBEHaviour 1
*RST
SOURce:FREQuency:CW?
// 60000000000
SCONfiguration:EXTErnal:IQOutput1:RCONnection:STATE?
// 1
SOURcel:IQ:OUTPup:ANALog:TYPE?
// DIFF

SCONfiguration:EXTErnal:PBEHaviour 0
*RST
SOURce:FREQuency:CW?
// 10000000000
SCONfiguration:EXTErnal:IQOutput1:RCONnection:STATE?
// 0
SOURcel:IQ:OUTPup:ANALog:TYPE?
// SING

```

Manual operation: See ["Preset behavior: Keep connections to external instruments"](#) on page 417

:SCONfiguration:EXTErnal:DIGital:DIRection?**:SCONfiguration:EXTErnal:IQOutput:DIRection?**

Queries the connector direction.

Return values:

```

<Direction>      NONE | IN | OUT
*RST:            IN

```

Example: See [Example "Connecting and configuring external instrument"](#) on page 633.

Usage: Query only

Manual operation: See ["Direction"](#) on page 417

:SCONfiguration:EXTErnal:DIGital:IQConnection:STATE?

Queries the status of the I/Q connection of the digital interfaces.

Return values:

```

<IQConnState>   0 | 1 | OFF | ON

```

Example: See [Example "Connecting and configuring external instrument"](#) on page 633.

Usage: Query only
Manual operation: See "[I/Q Connection](#)" on page 418

:SCONfiguration:EXTernal:DIGital:RCONnection:STATe?
:SCONfiguration:EXTernal:IQOutput:RCONnection:STATe?

Queries the status of the remote connection.

Return values:
 <State> 0 | 1 | OFF | ON

Example: See [Example "Connecting and configuring external instrument"](#) on page 633.

Usage: Query only
Manual operation: See "[Remote Connection Status](#)" on page 418

:SCONfiguration:EXTernal:DIGital:INAMe?
:SCONfiguration:EXTernal:IQOutput:INAMe?

Queries the name of the connected external instrument.

Return values:
 <InstrName> string
 Returns the name of the connected external instrument.
<InstrumentName> (SerialNumber) <Path>
 the instrument name, as retrieved via the DIG I/Q interface
<InstrumentName>[, <RfPath>] or <InstrumentName> (Serial-Number)
 the instrument name, as defined in with the "Remote Config" settings or as defined by the command `:SCONfiguration:EXTernal:REMOte:ADD`

Example: See [Example "Connecting and configuring external instrument"](#) on page 633.

Usage: Query only
Manual operation: See "[Instrument Name](#)" on page 419

:SCONfiguration:EXTernal:DIGital:RF:COUPLing <RfCouplingState>
:SCONfiguration:EXTernal:IQOutput:RF:COUPLing <RfCouplingState>

Enables/disables coupling all major RF setting (like the frequency, level and RF state) of the external instrument to the R&S SMBV100B.

Parameters:
 <RfCouplingState> 0 | 1 | OFF | ON
 *RST: 1

Example: See [Example "Connecting and configuring external instrument"](#) on page 633.

Manual operation: See ["RF Couple"](#) on page 419

```
:SCONfiguration:EXTernal:DIGital:RF:FREQUency <Frequency>
:SCONfiguration:EXTernal:IQOutput:RF:FREQUency <Frequency>
```

In uncoupled mode, sets the RF frequency of the external instrument.

Parameters:

```
<Frequency>          float
                      Range:    100E3 to 3E9
                      Increment: 0.01
                      *RST:     1E9
```

Example:

```
SCONfiguration:EXTernal:IQOutput:RF:COUPling OFF
SCONfiguration:EXTernal:IQOutput:RF:FREQUency 2143E6
// RF frequency of the external instrument is RF = 2.143 GHz
```

Manual operation: See ["\(Delta\) RF Frequency/ RF Level"](#) on page 419

```
:SCONfiguration:EXTernal:DIGital:RF:FREQUency:OFFSet <FreqOffset>
:SCONfiguration:EXTernal:IQOutput:RF:FREQUency:OFFSet <FreqOffset>
```

In coupled mode, offsets the RF frequency of the external instrument with the selected delta value.

Parameters:

```
<FreqOffset>        float
                      Range:    -3E9 to 3E9
                      Increment: 0.01
                      *RST:     0
```

Example:

```
SOURce1:FREQUency:CW 2143E6
SCONfiguration:EXTernal:IQOutput:RF:COUPling ON
SCONfiguration:EXTernal:IQOutput:RF:FREQUency:OFFSet 20E6
// The resulting RF frequency of the external instrument is
// RF = 2143E6 + 20E6 = 2.163 GHz
// Where both the RF frequency and the frequency offset
// are applied at the external instrument
```

Manual operation: See ["\(Delta\) RF Frequency/ RF Level"](#) on page 419

```
:SCONfiguration:EXTernal:DIGital:RF:POWER <Power>
:SCONfiguration:EXTernal:IQOutput:RF:POWER <Power>
```

In uncoupled mode, sets the RF level of the external instrument.

Parameters:

<Power> float
 Range: -130 to 20
 Increment: 0.01
 *RST: -30

Example:

```
SOURce1:POWer:LEVel:IMMediate:AMPLitude -30
SCONfiguration:EXTErnal:IQOutput:RF:COUPling OFF
SCONfiguration:EXTErnal:IQOutput:RF:POWer -20
// RF level of the external instrument is -20 dB
```

Manual operation: See "(Delta) RF Frequency/ RF Level" on page 419

:SCONfiguration:EXTErnal:DIGital:RF:POWer:OFFSet <PowerOffset>
:SCONfiguration:EXTErnal:IQOutput:RF:POWer:OFFSet <PowerOffset>

In coupled mode, offsets the RF level of the external instrument with the selected delta value.

Parameters:

<PowerOffset> float
 Range: -100 to 100
 Increment: 0.01
 *RST: 0

Example:

```
SOURce1:POWer:LEVel:IMMediate:AMPLitude -30
SCONfiguration:EXTErnal:IQOutput:RF:COUPling ON
SCONfiguration:EXTErnal:IQOutput:RF:POWer:OFFSet -20
// RF level of the external instrument is -50 dB
// Where both the RF level and the level offset
// are applied at the external instrument
```

Manual operation: See "(Delta) RF Frequency/ RF Level" on page 419

:SCONfiguration:EXTErnal:DIGital:RF:STATe <RemConnState>
:SCONfiguration:EXTErnal:IQOutput:RF:STATe <RemConnState>

Queries/sets the RF output state of the connected external instrument.

Parameters:

<RemConnState> 0 | 1 | OFF | ON

Example:

```
SCONfiguration:EXTErnal:IQOutput:RF:COUPling ON
OUTput1:STATe ON
SCONfiguration:EXTErnal:IQOutput:RF:STATe?
// 1
```

Example:

```
SCONfiguration:EXTErnal:DIGital:RF:COUPling OFF
SCONfiguration:EXTErnal:DIGital:RF:STATe ON
```

Manual operation: See "RF State" on page 420

:SCONfiguration:EXTernal:REMote:SCAN

Scans the network for connected instruments.

Example: See [Example "Connecting and configuring external instrument"](#) on page 633.

Usage: Event

Manual operation: See ["Detect/Scan"](#) on page 421

:SCONfiguration:EXTernal:REMote:SCAN:STATe?

Queries if scanning is performed or not.

To start the scanning process, use the command `:SCONfiguration:EXTernal:REMote:SCAN` on page 643.

Return values:

<ScanState> 0 | 1 | OFF | ON
1
Scanning process running
0
Not scanning

Example: See [Example "Connecting and configuring external instrument"](#) on page 633.

Usage: Query only

Manual operation: See ["Detect/Scan"](#) on page 421

:SCONfiguration:EXTernal:REMote:LIST?

Lists all available instruments, found by the `:SCONfiguration:EXTernal:REMote:SCAN` command.

Return values:

<InstrNames> String
String with symbolic names and/or alias names

Example: See [Example "Connecting and configuring external instrument"](#) on page 633.

Usage: Query only

Manual operation: See ["External Instrument"](#) on page 422

:SCONfiguration:EXTernal:REMote:ADD <InstrName>, <HwChan>,
<TcplporUsbAddr>[, <RfPathNumber>]

Adds manually an external instrument to the list of available instruments.

Parameters:

<HwChan>	String
	Hardware channel (USB or LAN) used by the remote channel to the external instrument
	Range: "LAN" to "USB"
	*RST: "LAN"
<TcpIporUsbAddr>	String
	IP address or hostname of the connected external instrument
<RfPathNumber>	String
	Determines the number of RF paths the external instrument is equipped with
	Range: "1" to "2"
	*RST: "1"

Setting parameters:

<InstrName>	String
	Alias name of the instrument

Example: See [Example "Connecting and configuring external instrument"](#) on page 633.

Usage: Setting only

Manual operation: See ["External Instrument"](#) on page 422

:SCONfiguration:EXTernal:REMOte:REName

Changes the symbolic name of the instrument.

Example: See [Example "Connecting and configuring external instrument"](#) on page 633.

Usage: Setting only

:SCONfiguration:EXTernal:DIGital:REMOte:DETECT?

Searches for external instruments connected to the particular digital interfaces.

Return values:

<DetectedInstr>	string
	If the detection fails, the query returns "None".

Example: See [Example "Connecting and configuring external instrument"](#) on page 633.

Usage: Query only

Manual operation: See ["Detect/Scan"](#) on page 421

```
:SCONfiguration:EXTernal:DIGital:REMote:ISElect <InstrName>[, <RfPath>]
:SCONfiguration:EXTernal:IQOutput:REMote:ISElect <InstrName>[, <RfPath>]
```

Select an external instrument for the selected connector.

Parameters:

<InstrName> String
 Instrument alias name, as retrieved with the command :
 [SCONfiguration:EXTernal:REMote:LIST?](#) or defined with
 the command :[SCONfiguration:EXTernal:REMote:ADD](#).

<RfPath> String
 Determines the used RF output of the external instrument.

Example: See [Example "Connecting and configuring external instrument"](#)
 on page 633.

Manual operation: See ["External Instrument"](#) on page 422

```
:SCONfiguration:EXTernal:DIGital:REMote:CONNECT
:SCONfiguration:EXTernal:IQOutput:REMote:CONNECT
```

Triggers the connection establishment.

Example: See [Example "Connecting and configuring external instrument"](#)
 on page 633.

Usage: Event

Manual operation: See ["Apply and Connect"](#) on page 423

```
:SCONfiguration:EXTernal:DIGital:REMote:INFO?
:SCONfiguration:EXTernal:IQOutput:REMote:INFO?
```

Queries information on the external instrument.

Return values:

<Info> string
 Returns information in one of the following formats:
 "None"
 An external instrument is not assigned
 <**SymbolicName**>,<**RemoteChannel**>,<**RemoteAd-**
 <**dress**>,<**RF Path**>
 An external instrument is assigned, but not connected
 <**SymbolicName**>,<**RemoteChannel**>,<**RemoteAd-**
 <**dress**>,<**RF Path**>[,<***IDN? String**>]
 An external instrument is assigned and connected

Example: :[SCONfiguration:EXTernal:DIGital:REMote:INFO?](#)
 "SGT (101676)", "LAN", "rssgt100a101676", "A",
 "Rohde&Schwarz,SGT100A,1419.4501k02/101676,3.1.19.4-3.18.251.99"

Usage: Query only

Manual operation: See ["Remote Connection Status"](#) on page 418

:SCONfiguration:EXTernal:DIGital:REMote:DISConnect
:SCONfiguration:EXTernal:IQOutput:REMote:DISConnect

Disconnects the selected remote connection. To disconnect all remote connections at once, use the command `:SCONfiguration:EXTernal:REMote:DISConnect[:ALL]`.

Example: See [Example "Connecting and configuring external instrument"](#) on page 633.

Usage: Event

Manual operation: See ["Remote Connection Status"](#) on page 418

:SCONfiguration:EXTernal:REMote:INITialization:USER:CATalog?

Queries the names of the existing user defined/predefined initialization files.

Per default, the instrument stores user-defined files in the `/var/user/` directory. Use the command `M MEM:CDIRectory` to change the default directory to the currently used one.

Only files with extension `*.iec` are listed.

Example: See [Example "Connecting and configuring external instrument"](#) on page 633.

Usage: Query only

Manual operation: See ["Initialization Sequence"](#) on page 423

:SCONfiguration:EXTernal:DIGital:REMote:INITialization:FILE <Filename>
:SCONfiguration:EXTernal:IQOutput:REMote:INITialization:FILE <Filename>

Queries the currently selected initialization file.

Return values:

<Filename> string
 filename with file extension (`*.iec`)

Example: See [Example "Connecting and configuring external instrument"](#) on page 633.

Manual operation: See ["Initialization Sequence"](#) on page 423

:SCONfiguration:EXTernal:REMote:PURGe

Removes unused instruments from the pool of external instruments.

Example: See [Example "Connecting and configuring external instrument"](#) on page 633.

Usage: Event

Manual operation: See "Clean Unused/Clean All" on page 422

:SCONfiguration:EXTernal:REMote:CLEan

Removes all instruments from the pool of external instruments.

Example: See [Example "Connecting and configuring external instrument"](#) on page 633.

Usage: Event

Manual operation: See "Clean Unused/Clean All" on page 422

12.16 SOURce Subsystem

The SOURce subsystem contains the commands for configuring the digital and analog signals.

Common suffixes

The following common suffixes are used in remote commands:

Suffix	Value range	Description
SOURce<hw>	[1]	<ul style="list-style-type: none"> SOURce[1] = RF output (optional keyword) LF output = SOURce:LFOutput (SOURce is optional keyword)
ENTity<ch>	1	Optional keyword, provided for compatibility with R&S®SMW200A ENTity1:SOURce1 = SOURce1
OUTPut<ch>	[1] to 3	Available markers

- [Connector Settings](#)..... 648
- [SOURce:BBIN Subsystem](#)..... 652
- [Analog Modulation Subsystems](#)..... 659
- [SOURce:BB Subsystem](#)..... 680
- [SOURce:CORRection Subsystem](#)..... 802
- [SOURce:FREQuency Subsystem](#)..... 812
- [SOURce:INPut Subsystem](#)..... 821
- [SOURce:IQ Subsystem](#)..... 822
- [SOURce:IQ:OUTPut Subsystem](#)..... 824
- [SOURce:LFOutput Subsystem](#)..... 829
- [SOURce:LIST Subsystem](#)..... 842
- [SOURce:NOISe Subsystem](#)..... 855
- [SOURce:PGEN Subsystem](#)..... 857
- [SOURce:PHASe Subsystem](#)..... 858

- [SOURce:POWer Subsystem](#)..... 859
- [SOURce:ROSCillator Subsystem](#)..... 869
- [SOURce:SWEEp Subsystem](#)..... 874

12.16.1 Connector Settings

This section summarizes the commands of the `OUTPut` and `INPut` subsystems, necessary to configure the connectors settings. Listed are the commands for configuring the output signals and the inputs for trigger, data, and control signals.

The `...:USER<ch>:...` commands determine the global trigger threshold and input impedance values, that affect all trigger and control signal inputs. The connector settings concern to all digital modulations, the generation of waveforms or multi carrier signals, and all digital standards.

Refer to [Chapter 12.16.7, "SOURce:INPut Subsystem"](#), on page 821 for description of the commands for configuring the inputs for external modulation signals.

Required options

See [Chapter 10.2, "Configuring the Global Connectors"](#), on page 486.

Example: Global connectors settings configuration

```
SOURce1:INPut:USER1:DIRection INP
SOURce1:INPut:USER1:SIGNa1 TRIG1
SOURce1:INPut:USER3:DIRection INP
SOURce1:INPut:USER3:SIGNa1 NSEGM1

SOURce1:INPut:USER5:DIRection INP
SOURce1:INPut:USER5:SIGNa1 TRIG2
SOURce1:INPut:USER:TRIGger:LEVel 1.5
SOURce1:INPut:USER:PULM:LEVel 2

// the signal threshold at USER 1-2 is 1.5 V
// this applies to all input signal, i.e. TRIG1 and NSEGM1
// the signal threshold at USER 3-5 is 2 V
// this applies to all input signal, i.e. TRIG2

SOURce1:INPut:USER1:TRIGger:IMPedance G1K
SOURce1:INPut:USER1:TRIGger:SLOPe POS

SOURce1:INPut:USER2:DIRection OUTP
OUTPut1:USER2:SIGNa1 MARKA2

[:SOURce]:INPut:USER<ch>:DIRection..... 649
:OUTPut:USER<ch>:DIRection..... 649
[:SOURce]:INPut:USER<ch>:SIGNa1..... 649
:OUTPut:USER<ch>:SIGNa1..... 649
:OUTPut:USER<ch>:TRIGger[:IMMediate]..... 650
[:SOURce]:INPut:USER:CLOCK:LEVel..... 650
[:SOURce]:INPut:USER:TRIGger:LEVel..... 650
```

<code>[:SOURce]:INPut:USER:PULM:LEVel</code>	651
<code>[:SOURce]:INPut:USER:CLOCK:IMPedance</code>	651
<code>[:SOURce]:INPut:USER:TRIGger:IMPedance</code>	651
<code>[:SOURce]:INPut:USER:CLOCK:SLOPe</code>	651
<code>[:SOURce]:INPut:USER:TRIGger:SLOPe</code>	652

`[:SOURce]:INPut:USER<ch>:DIRection <Direction>`
`:OUTPut:USER<ch>:DIRection <Direction>`

Determines whether the connector is used as an input or an output.

Suffix:

USER<ch> 1 to 5

Parameters:

<Direction> INPut | OUTPut | UNUSed
 UNUSed = the connector is not defined

Example: See [Example "Global connectors settings configuration"](#)
 on page 648.

Manual operation: See ["User x Connector Direction"](#) on page 492

`[:SOURce]:INPut:USER<ch>:SIGNal <Signal>`

Determines the control signal that is input at the selected connector.

To define the connector direction, use the command `[:SOURce]:INPut:USER<ch>:DIRection`.

Suffix:

USER<ch> 1 to 5

Parameters:

<Signal> TRIG1 | CLOCK1 | NSEGM1 | NONE | SYNCIN
 TRIG1 = Global Trigger
 CLOCK1 = Global Clock
 NSEGM1 = Global Next Segment
 SYNCIN = Baseband Sync In
 NONE = none

Example: See [Example "Global connectors settings configuration"](#)
 on page 648.

Manual operation: See ["Signal"](#) on page 493

`:OUTPut:USER<ch>:SIGNal <Signal>`

Sets the control signal that is output at the selected connector.

To define the connector direction, use the command `:OUTPut:USER<ch>:DIRection`.

Suffix:

USER<ch> 1 to 5

Parameters:

<Signal> MARKA1 | MARKA2 | MARKA3 | NONE | SYNCOUT | SCLock | LATTenuation | BGATe | HOP | CWMODulation | TRIGgered | MTRigger | LOW | HIGH

MARKA<1 | 2 | 3> = Baseband Marker 1/2/3

MTRigger = Manual Trigger, available for USER5

SYNCOUT = Baseband Sync Out

SCLock = Symbol Clock

LATTenuation = Lev Att

BGATA = Burst Gate

HOP = HOP

CWMODulation = CW/Mod

TRIGgered = Triggered

MTRigger = Manual Trigger, available for USER5

LOW|HIGH = Always 0/1

NONE = none

*RST: MARKA1

Example:See [Example "Global connectors settings configuration"](#) on page 648**Manual operation:** See ["Signal"](#) on page 493**:OUTPut:USER<ch>:TRIGger[:IMMediate]**

Generates a short pulse signal and outputs it at the User connector.

This signal can serve as a common external trigger signal for triggering of several R&S SMBV100B, see [Example "Triggering several R&S SMBV100B instruments simultaneously"](#) on page 405.**Suffix:**

USER<ch> 5

Example:See [Example "Global connectors settings configuration"](#) on page 648.**Usage:**

Event

Manual operation: See ["Execute Trigger"](#) on page 494**[:SOURce]:INPut:USER:CLOCK:LEVel <Level>****[:SOURce]:INPut:USER:TRIGger:LEVel <Level>**

Sets the threshold for any input signal at the User1-2 connectors.

Parameters:

<Level> float
 Range: 0.1 to 2
 Increment: 0.1
 *RST: 1

Example: See [Example "Global connectors settings configuration"](#) on page 648.

Manual operation: See ["Threshold User1-2 Input"](#) on page 494

[[:SOURce]:INPut:USER:PULM:LEVel <Level>

Sets the threshold for any input signal at the User3-5 connectors.

Parameters:

<Level> float
 Range: 0.1 to 2
 Increment: 0.1
 *RST: 1
 Default unit: V

Example: See [Example "Global connectors settings configuration"](#) on page 648.

Manual operation: See ["Threshold User3-5 Input/Threshold Pulse Input"](#) on page 495

[[:SOURce]:INPut:USER:CLOCK:IMPedance <Impedance>

[[:SOURce]:INPut:USER:TRIGGer:IMPedance <Impedance>

Selects the input impedance for the external trigger inputs.

Parameters:

<Impedance> G1K | G50
 *RST: G1K

Example: See [Example "Global connectors settings configuration"](#) on page 648.

Manual operation: See ["Impedance Clock/Trigger Input"](#) on page 495

[[:SOURce]:INPut:USER:CLOCK:SLOPe <Slope>

Sets the polarity of the active slope of an externally applied clock signal.

Parameters:

<Slope> NEGative | POSitive
 *RST: POSitive

Manual operation: See ["Clock Input Slope"](#) on page 495

[:SOURce]:INPut:USER:TRIGger:SLOPe <Slope>

Sets the polarity of the active slope of an applied instrument trigger.

Parameters:

<Slope> NEGative | POSitive
*RST: POSitive

Example: See [Example "Global connectors settings configuration"](#) on page 648

Manual operation: See ["Trigger Input Slope"](#) on page 495

12.16.2 SOURce:BBIN Subsystem



The SOURce:BBIN remote control commands will be supported in a future firmware version.

The baseband input cannot be activated.

The baseband input related commands in this section and in the [SCONfiguration Subsystem](#) have no effect because the baseband input interfaces cannot be activated.

The SOURce:BBIN subsystem contains the commands for setting the external digital baseband signal.

Required options

See ["Required Options"](#) on page 427.

Example: Applying an external digital baseband signal (Dig I/Q)

An external digital signal must be applied at the Dig I/Q connectors.

```
// set the sample rate source and query the value
SOURce1:BBIN:SRATE:SOURce DIN
SOURce1:BBIN:SRATE:ACTual?
SOURce1:BBIN:STATE ON

// enable automatic adjustment of the baseband input signal
SOURce1:BBIN:DIGital:ASETting:STATE ON
SOURce1:BBIN:MPERiod 10s
SOURce1:BBIN:ALEVel:EXECute
SOURce1:BBIN:CFACTOR?
SOURce1:BBIN:POWER:PEAK?
SOURce1:BBIN:POWER:RMS?
```

Example: Applying an external digital baseband signal (HS Dig I/Q)

An external digital signal must be applied at the HS Dig I/Q connectors.

```
SOURce1:BBIN:STATe 1
```

```
SOURce1:BBIN:SRATe:SOURce HSD
SOURce1:BBIN:CHANnel0:NAME?
SOURce1:BBIN:CHANnel0:SRATe?
// 100000000
SOURce1:BBIN:CHANnel0:POWer:CFACtor 0.5
SOURce1:BBIN:CHANnel0:POWer:PEAK 3
SOURce1:BBIN:CHANnel0:POWer:RMS?
// 2.5
SOURce1:BBIN:CHANnel0:BB:STATe 1
SOURce1:BBIN:SRATe:SUM?
// 100000000
SOURce1:BBIN:SRATe:MAX?
// 1250000000
```

```
// to set the sample rate per channel
SOURce1:BBIN:SRATe:SOURce USER
SOURce1:BBIN:CHANnel0:SRATe 500000000
SOURce1:BBIN:SRATe:SUM?
// 500000000
```

```
SOURce1:BBIN:MPERiod 3
SOURce1:BBIN:ALEVel:EXECute
```

[SOURce<hw>]:BBIN:STATe.....	654
[SOURce<hw>]:BBIN:DIGital:SOURce.....	654
[SOURce<hw>]:BBIN:DIGital:INterface.....	654
[SOURce<hw>]:BBIN:CHANnel<ch0>:BB.....	654
[SOURce<hw>]:BBIN:CHANnel<ch0>:BB:STATe.....	655
[SOURce<hw>]:BBIN:CHANnel<ch0>:NAME.....	655
[SOURce<hw>]:BBIN:CHANnel<ch0>:POWer:CFACtor.....	655
[SOURce<hw>]:BBIN:CHANnel<ch0>:POWer:PEAK.....	655
[SOURce<hw>]:BBIN:CHANnel<ch0>:POWer:RMS.....	656
[SOURce<hw>]:BBIN:CHANnel<ch0>:SRATe.....	656
[SOURce<hw>]:BBIN:SRATe:SUM?.....	656
[SOURce<hw>]:BBIN:SRATe:MAX?.....	656
[SOURce<hw>]:BBIN:MODE.....	657
[SOURce<hw>]:BBIN:SRATe:SOURce.....	657
[SOURce<hw>]:BBIN:SRATe[ACTual]?.....	657
[SOURce<hw>]:BBIN:DIGital:ASETting:STATe.....	657
[SOURce<hw>]:BBIN:MPERiod.....	658
[SOURce<hw>]:BBIN:ALEVel:EXECute.....	658
[SOURce<hw>]:BBIN:POWer:CFACtor.....	658
[SOURce<hw>]:BBIN:POWer:PEAK.....	658
[SOURce<hw>]:BBIN:POWer:RMS?.....	659
[SOURce<hw>]:BBIN:CDEVice?.....	659

[[:SOURce<hw>]:BBIN:STATe <State>

Switches the feeding of an external analog signal into the signal path on/off.

Parameters:

<State> 0 | 1 | OFF | ON
*RST: 0

Example: See [Example "Applying an external digital baseband signal \(HS Dig I/Q\)"](#) on page 652.

Manual operation: See ["State"](#) on page 429

[[:SOURce<hw>]:BBIN:DIGital:SOURce <DigInpSource>

Defines the connector used as an external signal source.

Parameters:

<DigInpSource> CODER1
*RST: CODER1

Example: See [Example "Applying an external digital baseband signal \(HS Dig I/Q\)"](#) on page 652.

[[:SOURce<hw>]:BBIN:DIGital:INTerface <BBinDigInterfac>

Selects the input connector at that the signal is fed.

Parameters:

<BBinDigInterfac> HSDin | DIN
DIN
Dig I/Q
HSDin
HS Dig I/Q
*RST: HSDin

Example: See [Example "Applying an external digital baseband signal \(HS Dig I/Q\)"](#) on page 652.

Manual operation: See ["Interface"](#) on page 429

[[:SOURce<hw>]:BBIN:CHANnel<ch0>:BB <BbinlqHsChBb>

Sets the baseband to that the channel is mapped.

Parameters:

<BbinlqHsChBb> NONE | A | B | C | D | E | F | G | H
*RST: NONE

Example: See [Example "Applying an external digital baseband signal \(HS Dig I/Q\)"](#) on page 652.

Options: R&S SMBVB-B9

[:SOURce<hw>]:BBIN:CHANnel<ch0>:BB:STATe <BbinIqHsChanSta>

Activates the channel.

Parameters:

<BbinIqHsChanSta> 0 | 1 | OFF | ON
*RST: 0

Example: See [Example "Applying an external digital baseband signal \(HS Dig I/Q\)"](#) on page 652.

Manual operation: See "BB" on page 432

[:SOURce<hw>]:BBIN:CHANnel<ch0>:NAME <BbinIqHsChanNam>

Queries the channel name.

Parameters:

<BbinIqHsChanNam> string

Example: See [Example "Applying an external digital baseband signal \(HS Dig I/Q\)"](#) on page 652.

Manual operation: See "Name" on page 431

[:SOURce<hw>]:BBIN:CHANnel<ch0>:POWER:CFACTOR <BbinIqHsChCrFac>

Sets the crest factor of the individual channels.

Parameters:

<BbinIqHsChCrFac> float
Range: 0 to 30
Increment: 0.01
*RST: 0

Example: See [Example "Applying an external digital baseband signal \(HS Dig I/Q\)"](#) on page 652.

Manual operation: See "Crest Factor" on page 432

[:SOURce<hw>]:BBIN:CHANnel<ch0>:POWER:PEAK <BbinHsChPoPeak>

Sets the peak level per channel relative to full scale.

Parameters:

<BbinHsChPoPeak> float
Range: -60 to 3.02
Increment: 0.01
*RST: 0

Example: See [Example "Applying an external digital baseband signal \(HS Dig I/Q\)"](#) on page 652.

Manual operation: See ["Peak Level"](#) on page 432

[:SOURce<hw>]:BBIN:CHANnel<ch0>:POWer:RMS <BbinIqHsChPoRms>

Queries the estimated RMS level.

Parameters:

<BbinIqHsChPoRms> float

Range: -100 to 10

Increment: 0.01

*RST: 0

Example: See [Example "Applying an external digital baseband signal \(HS Dig I/Q\)"](#) on page 652.

Manual operation: See ["Level"](#) on page 432

[:SOURce<hw>]:BBIN:CHANnel<ch0>:SRATe <BbinIqHsChSaRat>

Sets the sample rate per channel.

Parameters:

<BbinIqHsChSaRat> float

Range: 400 to 100E6

Increment: 0.001

*RST: 100E6

Example: See [Example "Applying an external digital baseband signal \(HS Dig I/Q\)"](#) on page 652.

Manual operation: See ["Sample Rate"](#) on page 432

[:SOURce<hw>]:BBIN:SRATe:SUM?

[:SOURce<hw>]:BBIN:SRATe:MAX?

Queries the maximum sample rate.

Return values:

<DigIqHsOutSRMax> integer

Range: 1050E6 to 1250E6

*RST: 1050E6

Example: See [Example "Applying an external digital baseband signal \(HS Dig I/Q\)"](#) on page 652.

Usage: Query only

Options: R&S SMBVB-B9

Manual operation: See ["Aggregated Link Sample Rate"](#) on page 432

[:SOURce<hw>]:BBIN:MODE <Mode>

Defines that a digital external signal is applied.

Parameters:

<Mode> DIGital
*RST: DIGital

Example: See [Example "Applying an external digital baseband signal \(HS Dig I/Q\)"](#) on page 652.

[:SOURce<hw>]:BBIN:SRATe:SOURce <Source>

Sets the digital interface used to estimate the sample rate.

Parameters:

<Source> DIN | HSDin
DIN
Estimates the sample rate based on the digital input signal.
HSDin
Enabled for [:SOURce<hw>]:BBIN:DIGital:INTerface
HSDin
*RST: HSDin

Example: See [Example "Applying an external digital baseband signal \(HS Dig I/Q\)"](#) on page 652.

Manual operation: See ["Sample Rate Source"](#) on page 429

[:SOURce<hw>]:BBIN:SRATe[:ACTual]?

Queries the sample rate of the external digital baseband signal.

Return values:

<Actual> float

Example: See [Example "Applying an external digital baseband signal \(HS Dig I/Q\)"](#) on page 652.

Usage: Query only

Manual operation: See ["Sample Rate Value"](#) on page 434

[:SOURce<hw>]:BBIN:DIGital:ASETting:STATe <State>

Activates automatic adjustment of the baseband input signal.

Parameters:

<State> 0 | 1 | OFF | ON
*RST: 1

Example: See [Example "Applying an external digital baseband signal \(HS Dig I/Q\)"](#) on page 652.

Manual operation: See ["DIG IQ Auto Setting"](#) on page 432

[:SOURce<hw>]:BBIN:MPERiod <MPeriod>

Sets the recording duration for measuring the baseband input signal by executed [:SOURce<hw>]:BBIN:ALEVel:EXECute.

Parameters:

<MPeriod> integer
 Range: 1 to 32
 *RST: 2
 Default unit: s

Example: See [Example "Applying an external digital baseband signal \(HS Dig I/Q\)"](#) on page 652.

Manual operation: See ["Measurement Period"](#) on page 433

[:SOURce<hw>]:BBIN:ALEVel:EXECute

Starts measuring the input signal. The measurement estimates the crest factor, peak and RMS level.

Example: See [Example "Applying an external digital baseband signal \(HS Dig I/Q\)"](#) on page 652.

Usage: Event

Manual operation: See ["Auto Level Set"](#) on page 433

[:SOURce<hw>]:BBIN:POWER:CFACTOR <CFactor>

Sets the crest factor of the external baseband signal.

Parameters:

<CFactor> float
 Range: 0 to 30
 Increment: 0.01
 *RST: 0
 Default unit: dB

Example: See [Example "Applying an external digital baseband signal \(Dig I/Q\)"](#) on page 652.

Manual operation: See ["Crest Factor"](#) on page 435

[:SOURce<hw>]:BBIN:POWER:PEAK <Peak>

Peak level of the external baseband signal relative to full scale of 0.5 V (in terms of dB full scale).

Parameters:

<Peak> float
 Range: -60 to 3.02
 Increment: 0.01
 *RST: 0
 Default unit: dBfs

Example: See [Example "Applying an external digital baseband signal \(Dig I/Q\)"](#) on page 652

Manual operation: See ["Peak Level"](#) on page 435

[:SOURce<hw>]:BBIN:POWER:RMS?

Queries the RMS level of the external digital baseband signal.

Return values:

<Rms> float
 Range: -100 to 10
 Increment: 0.01
 *RST: 0

Example: see [Example "Applying an external digital baseband signal \(Dig I/Q\)"](#) on page 652

Usage: Query only

Manual operation: See ["Level"](#) on page 435

[:SOURce<hw>]:BBIN:CDEvice?

Indicates the ID of an externally connected Rohde & Schwarz Instrument or Rohde & Schwarz device.

Return values:

<CDevice> string
 "None" - no device is connected.

Example: SOURce:BBIN:CDEvice?
 Queries the connected device ID.

Usage: Query only

Manual operation: See ["Connected Device"](#) on page 430

12.16.3 Analog Modulation Subsystems

Option: see [Chapter 6.11.1, "Required Options"](#), on page 319.

The subsystems in this section describe all commands for analog modulation of the RF signal. Divided in separate sections, you can configure amplitude modulation (AM), frequency modulation (FM), phase modulation (PhiM) and pulse modulation (PULM).

You can perform each of the modulations either with an internally generated modulation signal or with an externally applied signal.

To configure the internal signal, use the commands listed in [Chapter 12.16.10](#), "SOURce:LFOutput Subsystem", on page 829.

For more information:

See [Chapter 6.11](#), "Analog Modulations", on page 319.

12.16.3.1 SOURce:MODulation Subsystem

The command in this subsystem allows you to disable all active modulations at once, and, vice versa, to restore the last active ones.

[:SOURce<hw>]:MODulation[:ALL][:STATe] <State>

Activates all modulations that were active before the last switching off.

Parameters:

<State> 0 | 1 | OFF | ON
 *RST: 0

Example:

```
SOURce1:AM1:DEPTh 30
SOURce1:AM1:SOURce LF1
SOURce1:AM1:STATe 1
SOURce1:FM1:DEVIation 1000
SOURce1:FM1:STATe 1
// disable both modulation
SOURce1:MODulation:ALL:STATe 0
SOURce1:AM1:STATe?
// 0
SOURce1:FM1:STATe?
// 0
// enable both modulation
SOURce1:MODulation:ALL:STATe 1
SOURce1:AM1:STATe?
// 1
SOURce1:FM1:STATe?
// 1
```

Manual operation: See "[Mod on/off]" on page 321

12.16.3.2 SOURce:AM Subsystem

Option: R&S SMBVB-K720

The AM subsystem contains the commands for setting the amplitude modulation and also the broadband amplitude modulation.



Activation of amplitude modulation deactivates ARB, I/Q modulation, digital modulation and all digital standards.

The following examples show some variants for generating AM signals.

Example: Creating an amplitude modulated RF signal

Using the internal LF generator, the following command sequence configures an amplitude modulated signal.

```
// Reset the instrument to start from a defined state
*RST

// Set RF frequency and amplitude
SOURcel:FREQuency:CW 6000000000
SOURcel:POWer:LEVel:IMMediate:AMPLitude -25

// Configure the modulation signal
SOURcel:LFOutput1:SHAPE SINE
SOURcel:LFOutput1:FREQuency 20000

// Configure the amplitude modulation settings and switch AM on
SOURcel:AM1:SOURce LF1
SOURcel:AM1:DEPTTh 30
SOURcel:AM:RATio 40
SOURcel:AM1:DEVIation:MODE UNC
SOURcel:AM1:STATe 1
```

Example: Using combined LF signals

Using the internal LF generators of both paths, the following command sequences configure an amplitude modulated signal with determined deviations depths.

```
// Configure the AM modulation settings with combined LF signal sources
SOURcel:AM1:SOURce LF1
SOURcel:AM1:DEPTTh 32
// Select the modulation signal source for the second path
SOURcel:AM2:SOURce LF2
// Combine the signals of both paths with fixed total deviation depth
SOURcel:AM1:DEVIation:MODE TOT
SOURcel:AM1:DEPTTh:SUM 60

// Query the deviation depth of modulation signal in the second path
SOURcel:AM2:DEPTTh?
// Response: 28

// Combine the signals of both paths with fixed ratio
SOURcel:AM1:DEVIation:MODE RAT
SOURcel:AM1:RATio 100
SOURcel:AM2:DEPTTh 25

// Query the deviation depth of modulation signal in the first path
SOURcel:AM1:DEPTTh?
// Response: 25
```

```
SOURce1:AM1:STATe 1
SOURce1:AM2:STATe 1
```

Example: Using an external signal source

Using an external signal source, you can additionally determine whether you want to use only the AC component of the external modulation signal.

```
// Reset the instrument to start from a defined state
*RST

// Set frequency and amplitude
SOURce1:FREQuency:CW 6000000000
SOURce1:POWer:LEVel:IMMediate:AMPLitude -25

// Configure the amplitude modulation settings and turn on AM
SOURce1:AM1:SOURce EXT1
SOURce1:AM1:DEPTTh 40

// Query the input sensitivity at the external modulation input
SOURce1:AM1:SENSitivity?
// Response: 40
// Since the voltage value for full modulation is 1V,
// the resulting sensitivity is precisely 50%/V.
// This value is assigned to the voltage value for full
// modulation of the input.

// Select the coupling mode AC for external amplitude modulation
SOURce1:INPut:MODext:COUPling1 AC

// For external AM signal input, adjust the sensitivity
SOURce1:AM1:SOURce EXT1
SOURce1:AM1:SENSitivity 25
SOURce1:AM1:SENSitivity?
Response: 25

// Switch on AM and RF signal output
SOURce1:AM1:STATe 1
OUTPut1:STATe 1
```

The following commands are available:

[:SOURce<hw>]:AM<ch>:STATe	663
[:SOURce<hw>]:AM<ch>:SOURce	663
[:SOURce<hw>]:AM<ch>[:DEPTTh]	663
[:SOURce<hw>]:AM:DEPTTh:SUM	664
[:SOURce<hw>]:AM:DEVIation:MODE	664
[:SOURce<hw>]:AM:RATIo	664
[:SOURce<hw>]:AM<ch>:SENSitivity	665

[:SOURce<hw>]:AM<ch>:STATe <State>

Activates amplitude modulation.

Suffix:

<ch> 1 to 2
Modulation signal channel

Parameters:

<State> 0 | 1 | OFF | ON
*RST: 0

Example: See [Example "Creating an amplitude modulated RF signal"](#) on page 661.

Manual operation: See ["State"](#) on page 325

[:SOURce<hw>]:AM<ch>:SOURce <Source>

Selects the modulation source for amplitude modulation.

Suffix:

<ch> 1 to 2
Modulation signal channel

Parameters:

<Source> EXT1 | NOISe | LF2 | LF1 | EXTeRnal | INTeRnal
LF1|LF2
Uses an internally generated LF signal.
EXT1
Uses an externally supplied LF signal.
NOISe
Uses the internally generated noise signal.
INTeRnal
Uses the internally generated signal of LF1.
EXTeRnal
Uses an external LF signal (EXT1).

Example: See [Example "Creating an amplitude modulated RF signal"](#) on page 661.

Manual operation: See ["Source"](#) on page 325

[:SOURce<hw>]:AM<ch>[:DEPTH] <Depth>

Sets the depth of the amplitude modulation in percent.

Suffix:

<ch> 1 to 2
Modulation signal channel

Parameters:

<Depth> float
 Range: 0 to 100
 Increment: 0.1

Example: See [Example "Creating an amplitude modulated RF signal"](#) on page 661.

Manual operation: See ["Depth"](#) on page 328

[:SOURce<hw>]:AM:DEPTH:SUM <AmDepthSum>

Sets the total depth of the LF signal when using combined signal sources in amplitude modulation.

Parameters:

<AmDepthSum> float
 Range: 0 to 100
 Increment: 0.1
 *RST: 30

Example: See [Example "Using combined LF signals"](#) on page 661.

[:SOURce<hw>]:AM:DEVIation:MODE <AmDevMode>

Selects the coupling mode. The coupling mode parameter also determines the mode for fixing the total depth.

Parameters:

<AmDevMode> UNCOupled | TOTal | RATio

UNCOupled

Does not couple the LF signals.
 The deviation depth values of both paths are independent.

TOTal

Couples the deviation depth of both paths.

RATio

Couples the deviation depth ratio of both paths

*RST: UNCOupled

Example: See [Example "Using combined LF signals"](#) on page 661.

[:SOURce<hw>]:AM:RATio <Ratio>

Sets the deviation ratio (path#2 to path#1) in percent.

Parameters:

<Ratio> float
 Range: 0 to 100
 Increment: 0.01
 *RST: 100

Example: See [Example "Creating an amplitude modulated RF signal"](#) on page 661.

Manual operation: See ["Ratio Path2/Path1"](#) on page 329

[:SOURce<hw>]:AM<ch>:SENSitivity <Sensitivity>

Sets the sensitivity of the external signal source for amplitude modulation in %V.

Parameters:

<Sensitivity>	float
	Range: 0 to 100
	Increment: 0.1
	*RST: 30

Example: See [Example "Using an external signal source"](#) on page 662.

Manual operation: See ["Sensitivity"](#) on page 328

12.16.3.3 SOURce:FM Subsystem

Option: R&S SMBVB-K720

The FM subsystem contains the commands for setting the frequency modulation.

Example: Creating a frequency modulated RF signal

Using the internal LF generator, the following command sequence configures a frequency modulated signal.

```
// Reset the instrument to start from a defined state
*RST

// Set RF frequency and amplitude
SOURce1:FREQuency:CW 6000000000
SOURce1:POWer:LEVel:IMMediate:AMPLitude -25

// Configure the modulation signal
SOURce1:LFOutput1:SHAPE SINE
SOURce1:LFOutput1:FREQuency 20000

// Configure the frequency modulation settings and switch FM on
SOURce1:FM1:SOURce LF1
SOURce1:FM1:DEVIation 1000
SOURce1:FM:RATio 40
SOURce1:FM:MODE LNOise
SOURce1:FM1:STATe 1

// Switch on LF and RF signal output
SOURce1:LFOutput1:STATe 1
OUTPut1:STATe 1
```

Example: Using combined LF signals

Using the internal LF generators of both paths, the following command sequences configure a frequency modulated signal with determined deviations.

```
// Configure the FM modulation settings with combined LF signal sources
SOURcel:FM1:SOURce LF1
SOURcel:FM1:DEVIation 1000
// Select the modulation signal source for the second path
SOURcel:FM2:SOURce LF2
// Combine the signals of both paths with fixed total deviation depth
SOURcel:FM1:DEVIation:MODE TOT
SOURcel:FM1:DEVIation:SUM 5000

// Query the deviation depth of modulation signal in the second path
SOURcel:FM2:DEVIation?
// Response: 4000

// Combine the signals of both paths with fixed ratio
SOURcel:FM1:DEVIation:MODE RAT
SOURcel:FM1:RATio 100
SOURcel:FM2:DEVIation 10000

// Query the deviation depth of modulation signal in the first path
SOURcel:FM1:DEVIation?
// Response: 1000

SOURcel:FM1:STATe 1
SOURcel:FM2:STATe 1
```

Example: Using an external signal source

Alternatively configure the frequency modulation settings with an external modulation signal.

```
// Reset the instrument to start from a defined state
*RST

// Set RF frequency and amplitude
SOURcel:FREQuency:CW 6000000000
SOURcel:POWer:LEVel:IMMediate:AMPLitude -25

// Configure the frequency modulation settings and switch FM on
SOURcel:FM1:SOURce EXT1
SOURcel:FM1:DEVIation 5000

// Query the input sensitivity at the external modulation input
:SOURcel:FM1:SENSitivity?
// Response: 1000
// since the voltage value for full modulation is 1V,
// the resulting sensitivity is precisely 5000 Hz/V.
```

```
// Switch on FM and RF signal output
SOURce1:FM1:STATe 1
OUTPut1:STATe 1
```

The following commands are available:

[:SOURce<hw>]:FM<ch>:STATe	667
[:SOURce<hw>]:FM<ch>[:DEViation]	667
[:SOURce<hw>]:FM<ch>:SOURce	668
[:SOURce<hw>]:FM:DEViation:MODE	668
[:SOURce<hw>]:FM:DEViation:SUM	668
[:SOURce<hw>]:FM:RATio	669
[:SOURce<hw>]:FM:MODE	669
[:SOURce<hw>]:FM:SENSitivity?	669

[\[:SOURce<hw>\]:FM<ch>:STATe <State>](#)

Activates frequency modulation.

Suffix:

FM<ch> 1..2
determines the modulation signal channel.

Parameters:

<State> 0 | 1 | OFF | ON
*RST: 0

Example: See [Example "Creating a frequency modulated RF signal"](#)
on page 665.

Manual operation: See ["State"](#) on page 325

[\[:SOURce<hw>\]:FM<ch>\[:DEViation\] <Deviation>](#)

Sets the modulation deviation of the frequency modulation in Hz.

Suffix:

FM<ch> 1|2
Modulation signal channel

Parameters:

<Deviation> float
The maximum deviation depends on the RF frequency and the
selected modulation mode (see data sheet).

Range: 0 to max

Increment: 0.01

*RST: 1E3

Example: See [Example "Creating a frequency modulated RF signal"](#)
on page 665.

Manual operation: See ["Deviation"](#) on page 325

[:SOURce<hw>]:FM<ch>:SOURce <Source>

Selects the modulation source for frequency modulation.

Suffix:

FM<ch> 1|2
Modulation signal channel.

Parameters:

<Source> EXT1 | NOISe | LF2 | LF1 | INTernal | EXTernal

LF1|LF2

Uses an internally generated LF signal.

INTernal

Uses the internally generated signal of LF1.

EXTernal

Uses an external LF signal (EXT1).

NOISe

Uses the internally generated noise signal.

*RST: LF1 <FM1>; LF2 <FM2>

Example: See [Example "Creating a frequency modulated RF signal"](#) on page 665.

Manual operation: See ["Source"](#) on page 325

[:SOURce<hw>]:FM:DEVIation:MODE <FmDevMode>

Selects the coupling mode. The coupling mode parameter also determines the mode for fixing the total deviation.

Parameters:

<FmDevMode> UNCOupled | TOTal | RATio

UNCOupled

Does not couple the LF signals.

The deviation values of both paths are independent.

TOTal

Couples the deviation of both paths.

RATio

Couples the deviation ratio of both paths

*RST: UNCOupled

Example: See [Example "Using combined LF signals"](#) on page 666.

Manual operation: See ["Deviation Mode"](#) on page 325

[:SOURce<hw>]:FM:DEVIation:SUM <FmDevSum>

Sets the total deviation of the LF signal when using combined signal sources in frequency modulation.

Parameters:

<FmDevSum> float
 Range: 0 to 40E6
 Increment: 0.01
 *RST: 1E3

Example: See [Example "Using combined LF signals"](#) on page 666.

Manual operation: See ["Total Depth"](#) on page 326

[:SOURce<hw>]:FM:RATio <Ratio>

Sets the deviation ratio (path2 to path1) in percent.

Parameters:

<Ratio> float
 Range: 0 to 100
 Increment: 0.01
 *RST: 100

Example: See [Example "Creating a frequency modulated RF signal"](#) on page 665.

Manual operation: See ["Ratio Path2/Path1"](#) on page 326

[:SOURce<hw>]:FM:MODE <Mode>

Selects the mode for the frequency modulation.

Parameters:

<Mode> HBANdwidth | LNOise

HBANdwidth

Selects maximum range for modulation bandwidth.

LNOise

Selects optimized phase noise and spurious characteristics with reduced modulation bandwidth and FM deviation.

*RST: HBANdwidth

Example: See [Example "Creating a frequency modulated RF signal"](#) on page 665.

Manual operation: See ["Mode"](#) on page 326

[:SOURce<hw>]:FM:SENSitivity?

Queries the sensitivity of the externally supplied signal for frequency modulation. The sensitivity depends on the set modulation deviation.

Return values:

<Sensitivity> float
 Sensitivity in Hz/V.
 It is assigned to the voltage value for full modulation of the input.
 Range: 0 to max
 Increment: 0.01

Example: See [Example "Using an external signal source"](#) on page 666.

Usage: Query only

12.16.3.4 SOURce:PM Subsystem

Option: R&S SMBVB-K720

The PM subsystem contains the commands for setting the phase modulation. You can configure the internal modulation source (LF generator) with the commands listed in [Chapter 12.16.10, "SOURce:LFOutput Subsystem"](#), on page 829 .

Example: Performing phase modulation

The following example shows a command sequence to perform phase modulation.

```
// Reset the instrument to start from an initial state
*RST; *CLS

// Set the RF signal frequency and level
SOURce:FREQuency:CW 4000000000
SOURce:POWer:LEVel:IMMediate:AMPLitude -25

// Configure the phase modulation settings
SOURce1:LFOutput1:SHAPE SINE
SOURce1:LFOutput1:FREQuency 1000

// Select the LF signal generated by the internal modulation generator
// or the internally generated noise signal
SOURce1:PM1:DEVIation 1
SOURce1:PM1:SOURce LF1
// SOURce1:PM1:SOURce INTERNAL
// SOURce1:PM1:SOURce NOISE
SOURce1:PM1:RATio 40
SOURce1:PM1:MODE HBAN

// Alternatively configure the phase modulation settings for an
// external modulation source and query the input sensitivity.
SOURce1:PM1:SOURce EXT1
// SOURce1:PM1:SOURce EXTERNAL
SOURce1:PM1:DEVIation 1
SOURce1:PM1:SENSitivity?
// Response: 1
// since the voltage value for full modulation is 1V,
```

```
// the resulting sensitivity is precisely 1RAD/V.

// Activate the signal output
SOURce1:PM1:STATe 1
OUTPut1:STATe 1
```

Example: Using combined LF signals

Using the internal LF generators of both paths, the following command sequences configure an phase modulated signal with determined deviations.

```
// Configure the Phase modulation settings with combined LF signal sources
SOURce1:PM1:SOURce LF1
SOURce1:PM1:DEVIation 1.5
// Select the modulation signal source for the second path
SOURce1:PM2:SOURce LF2
// Combine the signals of both paths with fixed total deviation depth
SOURce1:PM1:DEVIation:MODE TOT
SOURce1:PM1:DEVIation:SUM 2

// Query the deviation depth of the modulation signal in the second path
SOURce1:PM2:DEVIation?
// Response: 0.5

// Combine the signals of both paths with fixed ratio
SOURce1:PM1:DEVIation:MODE RAT
SOURce1:PM1:RATio 80
SOURce1:PM2:DEVIation?
// Response: 1.2

// Query the deviation depth of modulation signal in the first path
SOURce1:PM1:DEVIation?
// Response: 1.5
```

```
SOURce1:FM1:STATe 1
SOURce1:FM2:STATe 1
```

The following commands are available:

<code>[SOURce<hw>]:PM<ch>:STATe</code>	671
<code>[SOURce<hw>]:PM<ch>:SOURce</code>	672
<code>[SOURce<hw>]:PM:MODE</code>	672
<code>[SOURce<hw>]:PM:DEVIation:MODE</code>	673
<code>[SOURce<hw>]:PM:DEVIation:SUM</code>	673
<code>[SOURce<hw>]:PM:RATio</code>	673
<code>[SOURce<hw>]:PM:SENSitivity?</code>	674
<code>[SOURce]:PM<ch>:[DEVIation]</code>	674

`[SOURce<hw>]:PM<ch>:STATe <State>`

Activates phase modulation.

Activation of phase modulation deactivates frequency modulation.

Suffix:

PM<ch> 1|2
Sets the modulation signal channel.

Parameters:

<State> 0 | 1 | OFF | ON
*RST: 0

Example: See [Example "Performing phase modulation"](#) on page 670.

Manual operation: See ["State"](#) on page 325

[:SOURce<hw>]:PM<ch>:SOURce <Source>

Selects the modulation source for phase modulation signal.

Suffix:

PM<ch> 1|2
Sets the modulation signal channel.

Parameters:

<Source> EXT1 | NOISe | LF1 | LF2 | INTernal | EXTernal

LF1|LF2

Uses an internally generated LF signal.

EXT1

Uses an externally supplied LF signal.

NOISe

Uses the internally generated noise signal.

INTernal

Uses the internally generated signal of LF1.

EXTernal

Uses an external LF signal (EXT1).

Example: See [Example "Performing phase modulation"](#) on page 670.

Manual operation: See ["Source"](#) on page 325

[:SOURce<hw>]:PM:MODE <Mode>

Selects the mode for the phase modulation.

Parameters:

<Mode> HBANdwidth | HDEViation | LNOise

HBANdwidth

Sets the maximum available bandwidth.

HDEViation

Sets the maximum range for Φ M deviation.

LNOise

Selects a phase modulation mode with phase noise and spurious characteristics close to CW mode.

*RST: HBANdwidth

Example: See [Example "Performing phase modulation"](#) on page 670.

Manual operation: See ["Mode"](#) on page 327

[:SOURce<hw>]:PM:DEViation:MODE <PmDevMode>

Selects the coupling mode. The coupling mode parameter also determines the mode for fixing the total deviation.

Parameters:

<PmDevMode> UNCoupled | TOTal | RATio

UNCoupled

Does not couple the LF signals.

The deviation values of both paths are independent.

TOTal

Couples the deviation of both paths.

RATio

Couples the deviation ratio of both paths

*RST: UNCoupled

Example: See [Example "Using combined LF signals"](#) on page 671

[:SOURce<hw>]:PM:DEViation:SUM <PmDevSum>

Sets the total deviation of the LF signal when using combined signal sources in phase modulation.

Parameters:

<PmDevSum> float
 Range: 0 to 20
 Increment: 1E-6
 *RST: 1

Example: See [Example "Using combined LF signals"](#) on page 671

[:SOURce<hw>]:PM:RATio <Ratio>

Sets the deviation ratio (path2 to path1) in percent.

Parameters:

<Ratio> float
 Range: 0 to 100
 Increment: 0.01
 *RST: 100

Example: See [Example "Performing phase modulation"](#) on page 670.

Manual operation: See ["Ratio Path2/Path1"](#) on page 327

[:SOURce<hw>]:PM:SENSitivity?

Queries the sensitivity of the externally applied signal for phase modulation.

The returned value reports the sensitivity in RAD/V. It is assigned to the voltage value for full modulation of the input.

Return values:

<Sensitivity> float

Example: See [Example "Performing phase modulation"](#) on page 670.

Usage: Query only

[:SOURce]:PM<ch>[:DEVIation] <Deviation>

Sets the modulation deviation of the phase modulation in RAD.

Parameters:

<Deviation> float
 The maximal deviation depends on the RF frequency and the selected modulation mode (see data sheet).
 Range: 0 to max
 Increment: 1
 *RST: 1
 Default unit: RAD

Example: See [Example "Performing phase modulation"](#) on page 670.

Manual operation: See ["Deviation"](#) on page 326

12.16.3.5 SOURce:PULM Subsystem

Option: see [Chapter 6.11.1, "Required Options"](#), on page 319.

The PULM subsystem contains the commands for setting the pulse modulation.

- [Pulse Modulation Settings](#).....674

Pulse Modulation Settings

With the commands described in this section, you can configure the settings for pulse modulation, select the trigger mode and determine delay times for the pulse modulation signal.

Example: Perform pulse modulation

The example shows a command sequence to perform pulse modulation.

```
// Reset the instrument to start from an initial state
*RST; *CLS

// Set the RF signal frequency and level
SOURce:FREQuency:CW 4000000000
SOURce:POWer:LEVel:IMMediate:AMPLitude -25

// Configure the pulse modulation settings
// Select the internal modulation generator,
// set trigger mode, select pulse mode, transition type
// and select the polarity of the internally generated pulse video output
// Trigger a single pulse

SOURce:PULM:SOURce INT
SOURce:PULM:TRIGger:MODE SING
SOURce:PULM:MODE DOUB
SOURce:PULM:TTYPe SMO
SOURce:PULM:OUTPut:VIDeo:POLarity INVerted

SOURce:PULM:TRIG:IMM

// Alternatively configure the pulse modulation settings for
// external modulation source
// Select the source, set the polarity of the external signal,
// select the impedance for the external pulse modulation input/
// for the external pulse modulation trigger input
SOURce:PULM:SOURce EXT
SOURce:PULM:POLarity NORMal
SOURce:PULM:IMPedance G1K

// Configure the pulse generator settings
// Set pulse period, width, and delay
SOURce:PULM:PERiod 10 us
SOURce:PULM:WIDTh 8 us
SOURce:PULM:DOUBle:WIDTh 0.0000012
SOURce:PULM:DOUBle:DELay 0.0000045

// Activate the signal output
SOURce:PGENERator:OUTPut:STATe 1
SOURce:PULM:STATe 1
OUTPut1:STATe 1
```

The following commands are available:

[:SOURce<hw>]:PULM:MODE	676
[:SOURce<hw>]:PULM:TRIGger:MODE	676
[:SOURce]:PULM[:INTernal][:TRAIIn]:TRIGger:IMMediate	676
[:SOURce<hw>]:PULM:PERiod	677
[:SOURce<hw>]:PULM:WIDTh	677

[SOURce<hw>]:PULM:DELay.....	677
[SOURce<hw>]:PULM:DOUBle:DELay.....	677
[SOURce<hw>]:PULM:DOUBle:WIDTh.....	678
[SOURce<hw>]:PULM:DOUBle:STATe.....	678
[SOURce<hw>]:PULM:STATe.....	678
[SOURce<hw>]:PULM:SOURce.....	678
[SOURce<hw>]:PULM:TTYPe.....	678
[SOURce<hw>]:PULM:OUTPut:VIDeo:POLarity.....	679
[SOURce<hw>]:PULM:POLarity.....	679
[SOURce<hw>]:PULM:IMPedance.....	679

[SOURce<hw>]:PULM:MODE <Mode>

Selects the mode for the pulse modulation.

Parameters:

<Mode> SINGle | DOUBle

SINGle

Generates a single pulse.

DOUBle

Generates two pulses within one pulse period.

*RST: SINGle

Example: See [Example "Perform pulse modulation"](#) on page 675.

Manual operation: See ["Pulse Mode"](#) on page 330

[SOURce<hw>]:PULM:TRIGger:MODE <Mode>

Selects a trigger mode - auto, single, external, external single or external gated - for generating the modulation signal.

Parameters:

<Mode> AUTO | EXTernal | EGATe | SINGle | ESINGle

*RST: AUTO

Example: See [Example "Perform pulse modulation"](#) on page 675.

Manual operation: See ["Trigger Mode"](#) on page 330

[SOURce]:PULM[:INTernal][:TRAIIn]:TRIGger:IMMediate

If [:SOURce<hw>] :PULM:TRIGger:MODE SINGle, triggers the pulse generator.

Example: See [Example "Perform pulse modulation"](#) on page 675.

Manual operation: See ["Execute Single Trigger"](#) on page 333

[[:SOURce<hw>]:PULM:PERiod <Period>

Sets the period of the generated pulse, that means the repetition frequency of the internally generated modulation signal.

Parameters:

<Period> float
 The minimum value depends on the installed options
 R&S SMBVB-K22 or R&S SMBVB-K23
 Range: 20E-9 to 100
 Increment: 5E-9
 *RST: 10E-6

Example: See [Example "Perform pulse modulation"](#) on page 675.

Manual operation: See ["Pulse Period"](#) on page 332

[[:SOURce<hw>]:PULM:WIDTH <Width>

Sets the width of the generated pulse, that means the pulse length. It must be at least 20ns less than the set pulse period.

Parameters:

<Width> float
 Range: 20E-9 to 100
 Increment: 10E-9
 *RST: 2E-6

Example: See [Example "Perform pulse modulation"](#) on page 675.

Manual operation: See ["Pulse Width"](#) on page 332

[[:SOURce<hw>]:PULM:DELay <Delay>

Sets the pulse delay.

Parameters:

<Delay> float
 *RST: 1ms

Example: See [Example "Perform pulse modulation"](#) on page 675.

Manual operation: See ["Pulse Delay"](#) on page 333

[[:SOURce<hw>]:PULM:DOUBLE:DELay <Delay>

Sets the delay from the start of the first pulse to the start of the second pulse.

Parameters:

<Delay> float
 *RST: 1E-6

Example: See [Example "Perform pulse modulation"](#) on page 675.

Manual operation: See ["Double Pulse Delay"](#) on page 333

[:SOURce<hw>]:PULM:DOUBLE:WIDTH <Width>

Sets the width of the second pulse.

Parameters:

<Width> float
Increment: 5E-9

Example: See [Example "Perform pulse modulation"](#) on page 675.

Manual operation: See ["Double Pulse Width"](#) on page 333

[:SOURce<hw>]:PULM:DOUBLE:STATe <State>

Provided for backward compatibility with former Rohde & Schwarz signal generators.

Works like the command `[:SOURce<hw>] :PULM:MODE DOUBle`.

Parameters:

<State> 0 | 1 | OFF | ON
*RST: 0

[:SOURce<hw>]:PULM:STATe <State>

Activates pulse modulation.

Parameters:

<State> 0 | 1 | OFF | ON
*RST: 0

Example: See [Example "Perform pulse modulation"](#) on page 675.

Manual operation: See ["State"](#) on page 323

[:SOURce<hw>]:PULM:SOURce <Source>

Selects between the internal (pulse generator) or an external pulse signal for the modulation.

Parameters:

<Source> INTernal | EXTernal
*RST: INTernal

Example: See [Example "Perform pulse modulation"](#) on page 675.

Manual operation: See ["Source"](#) on page 323

[:SOURce<hw>]:PULM:TTYPe <Source>

Sets the transition mode for the pulse signal.

Parameters:

<Source> SMOothed | FAST

SMOothed

flattens the slew rate, resulting in longer rise/fall times.

FAST

enables fast transitions with shortest rise and fall times.

*RST: FAST

Example:See [Example "Perform pulse modulation"](#) on page 675.**Manual operation:**See ["Transition Type"](#) on page 323**[:SOURce<hw>]:PULM:OUTPut:VIDeo:POLarity <Polarity>**

Sets the polarity of the pulse video (modulating) signal, related to the RF (modulated) signal.

Parameters:

<Polarity> NORMal | INVerted

NORMal

the video signal follows the RF signal, that means it is high when RF signal is high and vice versa.

INVerted

the video signal follows in inverted mode.

*RST: NORMal

Example:See [Example "Perform pulse modulation"](#) on page 675.**Manual operation:**See ["Video Polarity"](#) on page 323**[:SOURce<hw>]:PULM:POLarity <Polarity>**

Sets the polarity of the externally applied modulation signal.

Parameters:

<Polarity> NORMal | INVerted

NORMal

Suppresses the RF signal during the pulse pause.

INVerted

Suppresses the RF signal during the pulse.

*RST: NORMal

Example:See [Example "Perform pulse modulation"](#) on page 675.**Manual operation:**See ["Polarity"](#) on page 335**[:SOURce<hw>]:PULM:IMPedance <Impedance>**

Sets the impedance for the external pulse trigger and pulse modulation input.

Parameters:

<Impedance> G50 | G10K
 *RST: G50

Example: See [Example "Perform pulse modulation"](#) on page 675.

Manual operation: See ["Impedance"](#) on page 335

12.16.4 SOURce:BB Subsystem

This subsystem contains all commands for digital signal generation. It is divided into several subsystems which are described separately.

- [SOURce:BB Subsystem General Commands](#)..... 680
- [SOURce:BB:DM Subsystem](#).....683
- [SOURce:BB:ARBitrary Subsystem](#).....707
- [Waveform, Data and List Format](#)..... 750
- [SOURce:BB:MCCW Subsystem](#)..... 771
- [SOURce:AWGN Subsystem](#)..... 787
- [SOURce:BB:IMPairment Subsystem](#)..... 794
- [SOURce:BB:GRAPhics Subsystem](#).....799
- [SOURce:BB:PROGress Subsystem General Commands](#).....802

12.16.4.1 SOURce:BB Subsystem General Commands

The following section describes the commands for setting the frequency shift and the phase offset for the signal at the output of the "Baseband" and "BB Input" blocks.

The following commands are available:

[:SOURce<hw>]:BBIN:FOFFset	680
[:SOURce<hw>]:BB:FOFFset	680
[:SOURce<hw>]:BBIN:POFFset	681
[:SOURce<hw>]:BB:POFFset	681
[:SOURce<hw>]:BB:ROUte	681
[:SOURce<hw>]:BBIN:ROUte	681
[:SOURce<hw>]:BB:POWer:PEAK?	682
[:SOURce<hw>]:BB:CFACtor?	682
[:SOURce<hw>]:BB:POWer:RMS?	682

[:SOURce<hw>]:BBIN:FOFFset <FOffset>

[:SOURce<hw>]:BB:FOFFset <FOffset>

Sets a frequency offset for the internal/external baseband signal. The offset affects the generated baseband signal.

Parameters:

<FOffset> float
 Range: depends on the installed options
 Increment: 0.01
 *RST: 0
 Default unit: Hz
 E.g. -60 MHz to +60 MHz (base unit)

Example:

SOURce1:BB:FOFFset 2MHZ

Manual operation: See ["Frequency Offset"](#) on page 227

[:SOURce<hw>]:BBIN:POFFset <POffset>

Sets the relative phase offset for the external baseband signal.

Parameters:

<POffset> float
 Range: -999.99 to 999.99
 Increment: 0.01
 *RST: 0
 Default unit: DEG

Example:

SOURce1:BBIN:POFFset 0.5

Manual operation: See ["Phase Offset"](#) on page 227

[:SOURce<hw>]:BB:POFFset <POffset>

Sets the relative phase offset for the selected baseband signal.

Parameters:

<POffset> float
 Range: 0 to 359.9
 Increment: 0.01
 *RST: 0
 Default unit: DEG

Example:

SOURce1:BB:POFFset 0.5DEG

Manual operation: See ["Phase Offset"](#) on page 227

[:SOURce<hw>]:BB:ROUte <Route>

[:SOURce<hw>]:BBIN:ROUte <Route>

Selects the signal route for the internal/external baseband signal.

Parameters:

<Route> A

Example:

SOURce1:BBIN:ROUte A

[[:SOURce<hw>]:BB:POWER:PEAK?

Queries the peak level of the baseband signal relative to full scale of 0.5 V (in terms of dB full scale).

Return values:

<Peak> float
Range: -145 to 30
Increment: 0.01
*RST: 0
Default unit: dBfs

Example:

BB:POW:PEAK
Queries the peak level of the baseband signal.

Usage: Query only

[[:SOURce<hw>]:BB:CFACTOR?

Queries the crest factor of the baseband signal.

Return values:

<CFactor> float
Range: 0 to 100
Increment: 0.01
*RST: 0
Default unit: dB

Example:

SOURce1:BB:CFACTOR?
Queries the crest factor of the baseband signal.

Usage: Query only

[[:SOURce<hw>]:BB:POWER:RMS?

Queries the RMS level of the baseband signal relative to full scale of 0.5V (in terms of dB full scale).

Return values:

<Rms> float
Range: -145 to 30
Increment: 0.01
*RST: 0
Default unit: dBfs

Example:

BB:POW:RMS?
Queries the rms level of the baseband signal.

Usage: Query only

12.16.4.2 SOURce:BB:DM Subsystem

This section lists the commands of the `SOURce:BB:DM` subsystem. The commands are divided into sections, where the last one describes how to use lists for digital modulation in remote control, and all other sections describe the configuration of the digital modulation.

Required options

See [Chapter 3.5.1, "Required Options"](#), on page 116

The commands are grouped in the following sections:

• Programming Examples	683
• General Commands	685
• Save/Recall Settings	687
• Filter Settings	689
• Modulation and Coding Settings	690
• Power Ramping	694
• Trigger Settings	696
• Marker Settings	699
• Clock Settings	701
• Handling List Files	701

Programming Examples

Example: Performing general tasks

This example shows how to enable custom digital modulation with predefined settings as basis for further customization (e.g. adjusting the data source); intermediate results and configuration are stored with the save/recall function.

```
// *****
// Reset instrument first
// *****
*RST; *CLS

SOURce:BB:DM:PRESet
SOURce:BB:DM:STANdard W3Gpp
SOURce:BB:DM:SRATe?
// 3840000
SOURce:BB:DM:CODing?
// WCDMA
SOURce:BB:DM:FORMat?
// QPSK45
SOURce:BB:DM:STATe ON
SOURce:BB:DM:SETTing:STORe "/var/user/ digMod/CustDM3GPP"

// *****
// Recall settings
// *****
```

```

MME:CDIR "/var/user/digMod"
SOURCE:BB:DM:SETTING:CATALOG?
// CusDigMod, cdm3gpp, CustDM3GPP
SOURCE:BB:DM:SETTING:DELETE "cdm3gpp"
SOURCE:BB:DM:SETTING:LOAD "CusDigMod"

// *****
// Change the data source
// *****
SOURCE:BB:DM:SOURCE?
// PRBS
SOURCE:BB:DM:PRBS:LENGTH?
// 9
SOURCE:BB:DM:SOURCE DLIST
// Set the default directory and query the existing data lists
MME:CDIR "/var/user/DLists"
SOURCE:BB:DM:DLIST:CATALOG?
// "DList1", "DList2"
// delete a list and create a new data list
SOURCE:BB:DM:DLIST:DELETE "DList1"
SOURCE:BB:DM:DLIST:SELECT "DList2"
// copy the content of an existing data list to the new data list
SOURCE:BB:DM:DLIST:COPY "DList3"
// query the content of the new data list and modify it (append data to it)
FORM ASCII
SOURCE:BB:DM:DLIST:DATA? 2048,1024
// 1,1,0,0,0, ...
SOURCE:BB:DM:DLIST:DATA:APPEND 1,1,1,0,0,0,1,1,0,1...
SOURCE:BB:DM:DLIST:SELECT "DList3"
// query the free memory and number of bit to be utilized
SOURCE:BB:DM:DLIST:FREE?
SOURCE:BB:DM:DLIST:POINTS?

```

Example: Adjusting clock, marker and trigger settings

The following example lists the provided commands

```

// *****
// Clock settings
// *****
SOURCE:BB:DM:CLOCK:SOURCE INTERNAL

// *****
// Configure and enable standard marker signals
// *****
SOURCE:BB:DM:TRIGGER:OUTPUT2:MODE PULSE
SOURCE:BB:DM:TRIGGER:OUTPUT2:PULSE:DIVIDER 5
SOURCE:BB:DM:TRIGGER:OUTPUT2:PULSE:FREQUENCY?
SOURCE:BB:DM:TRIGGER:OUTPUT3:MODE PATTERN
SOURCE:BB:DM:TRIGGER:OUTPUT3:PATTERN #HE0F52,20
SOURCE:BB:DM:TRIGGER:OUTPUT1:MODE RATIO

```

```

SOURce:BB:DM:TRIGger:OUTPut1:ONTime 40
SOURce:BB:DM:TRIGger:OUTPut1:OFFTime 20

SOURce:BB:DM:TRIGger:OUTPut2:DELay 16

// *****
// Configure and enable signal generation
// *****
SOURce:BB:DM:TRIGger:SEQuence SINGLE
SOURce:BB:DM:TRIGger:SEnGth 200
// the first 200 samples will be output after the next trigger event
SOURce:BB:DM:TRIGger:SEQuence ARETrigger
SOURce:BB:DM:TRIGger:SOURce EGT1
// external trigger signal must be provided at the connector
// configured for the external global trigger 1 signal
SOURce:BB:DM:TRIGger:EXternal:SYNChronize:OUTPut ON
SOURce:BB:DM:TRIGger:EXternal:DELay 200
SOURce:BB:DM:TRIGger:EXternal:INHibit 100

// with internal trigger source
SOURce:BB:DM:TRIGger:SEQuence AAUTO
SOURce:BB:DM:TRIGger:SOURce INTernal
SOURce:BB:DM:STAT ON
SOURce:BB:DM:TRIGger:EXEC

```

Example: Enable power ramping

The following example lists the provided commands

```

SOURce:BB:DM:PRAMp:SOURce INTernal
SOURce:BB:DM:PRAM:SHAP COS
SOURce:BB:DM:PRAMp:TIME 5
SOURce:BB:DM:PRAMp:RDELay 0
SOURce:BB:DM:PRAMp:FDELay -1
SOURce:BB:DM:PRAMp:ATTenuation 10
SOURce:BB:DM:PRAMp:BBONly:STATe ON
SOURce:BB:DM:PRAMp:STATe ON

```

General Commands

[:SOURce<hw>]:BB:DM:STATe <State>

Enables/disables digital modulation. Switching on digital modulation turns off all the other digital standards in the same signal path.

Parameters:

<State> 0 | 1 | OFF | ON
 *RST: 0

Example: See [Example "Performing general tasks"](#) on page 683

Manual operation: See ["State"](#) on page 118

[[:SOURce<hw>]:BB:DM:PRESet

Sets the default settings for digital modulation (*RST values specified for the commands).

Not affected is the state set with the command `SOURce<hw>:BB:DM:STATe`

Example: See [Example "Performing general tasks"](#) on page 683

Usage: Event

Manual operation: See ["Set To Default"](#) on page 118

[[:SOURce<hw>]:BB:DM:SRATe <SRate>

Sets the symbol rate in Hz/kHz/MHz or Symb/s / kSymb/s and MSymb/s.

Parameters:

<SRate> float
 Range: 400 to depends on the installed options
 Increment: 0.001
 *RST: 270833.333
 Default unit: Hz

Example: See [Example "Performing general tasks"](#) on page 683.

Manual operation: See ["Symbol Rate"](#) on page 119

[[:SOURce<hw>]:BB:DM:STANdard <Standard>

Selects predefined set of settings according to the selected standard, see [Table 3-6](#).

Parameters:

<Standard> USER | BLUetooth | DECT | ETC | GSM | GSMEdge | NADC | PDC | PHS | TETRa | W3GPp | TDSCdma | CFORward | CREVerse | WORLdspace | TFTS | APCOPH1C4fm | APCOPH1CQpsk | APCOPH2HCpm | APCOPH2HDQpsk | APCOPH2HD8PSKW | APCOPH2HD8PSKN | APCOPH1Lsm | APCOPH1Wcqpsk

A query returns the value `USER` if one the following is true:

- A user-defined custom digital modulation setting was loaded
- One of the associated settings was changed subsequent to the selection of a standard.

*RST: GSM

Example: See [Example "Performing general tasks"](#) on page 683

Manual operation: See ["Set according to Standard"](#) on page 118

[[:SOURce<hw>]:BB:DM:SOURce <Source>

Selects the data source.

Parameters:

<Source> ZERO | ONE | PRBS | PATtern | DLISt
 A sequence of 0 or 1, a pseudo-random sequence with different length, a pattern, or a data list.

*RST: PRBS

Example: See [Example "Performing general tasks"](#) on page 683

Manual operation: See ["Data Source"](#) on page 120

[:SOURce<hw>]:BB:DM:PATtern <Pattern>, <BitCount>

Selects the data pattern for the internal data source.

Parameters:

<Pattern> numeric

*RST: #H0

<BitCount> integer

Range: 1 to 64

*RST: 1

Example:

SOURce:BB:DM:SOURce PATT

SOURce:BB:DM:PATtern #B01110111010101010,17

Generates the user-defined sequence of 0/1 data.

Manual operation: See ["Data Source"](#) on page 120

[:SOURce<hw>]:BB:DM:PRBS[:LENGTH] <Length>

Defines the length of the pseudo-random sequence in accordance with the following equation:

$$\text{Length} = (2^{\text{Length}}) - 1$$

Parameters:

<Length> 9 | 11 | 15 | 16 | 20 | 21 | 23 | PN9 | PN11 | PN15 | PN16 | PN20 |
 PN21 | PN23

*RST: 9

Example: See [Example "Performing general tasks"](#) on page 683

Manual operation: See ["Data Source"](#) on page 120

Save/Recall Settings

[:SOURce<hw>]:BB:DM:STANdard:ULISt:CATalog?

[:SOURce<hw>]:BB:DM:SETTing:CATalog?

Queries the files with digital modulation respectively user standard settings in the default directory. Listed are files with the file extension *.dm and *.dm_stu.

Refer to [Chapter 12.6.2, "Accessing Files in the Default or in a Specified Directory"](#), on page 588 for general information on file handling in the default and a specific directory.

Return values:

<Catalog> "<filename1>,<filename2>,..."
Returns a string of file names separated by commas.

Example: See [Example "Performing general tasks"](#) on page 683

Usage: Query only

Manual operation: See ["Save/Recall"](#) on page 118

[:SOURCE<hw>]:BB:DM:STANDARD:ULIST:STORE <Filename>

[:SOURCE<hw>]:BB:DM:SETTING:STORE <Filename>

Stores the current settings into the selected file; the file extension (* .dm respectively * .dm_stu) is assigned automatically.

Refer to [Chapter 12.6.2, "Accessing Files in the Default or in a Specified Directory"](#), on page 588 for general information on file handling in the default and a specific directory.

Setting parameters:

<Filename> string

Example: See [Example "Performing general tasks"](#) on page 683

Usage: Setting only

Manual operation: See ["Save/Recall"](#) on page 118

[:SOURCE<hw>]:BB:DM:STANDARD:ULIST:LOAD <Filename>

[:SOURCE<hw>]:BB:DM:SETTING:LOAD <Filename>

Loads the selected file from the default or the specified directory. Loaded are files with extension * .dm respectively * .dm_stu.

Refer to [Chapter 12.6.2, "Accessing Files in the Default or in a Specified Directory"](#), on page 588 for general information on file handling in the default and a specific directory.

Setting parameters:

<Filename> string

Example: See [Example "Performing general tasks"](#) on page 683

Usage: Setting only

Manual operation: See ["Save/Recall"](#) on page 118

[[:SOURce<hw>]:BB:DM:STANdard:ULISt:DELeTe <Filename>

[[:SOURce<hw>]:BB:DM:SETTing:DELeTe <Filename>

Deletes the selected file from the default or specified directory. Deleted are files with the file extension *.dm respectively *.dm_stu.

Refer to [Chapter 12.6.2, "Accessing Files in the Default or in a Specified Directory"](#), on page 588 for general information on file handling in the default and a specific directory.

Setting parameters:

<Filename> string

Example: See [Example "Performing general tasks"](#) on page 683

Usage: Setting only

Manual operation: See ["Save/Recall"](#) on page 118

Filter Settings

[[:SOURce<hw>]:BB:DM:FIlTer:TYPE <Type>

The command selects the filter type.

When a standard is selected (:BB:DM:STAN), the filter type and filter parameter are set to the default value.

Parameters:

<Type> RCOSine | COSine | GAUSSs | LGAuss | CONE | COF705 |
 COEqualizer | COFequalizer | C2K3x | APCO25 | SPHase |
 RECTangle | USER | PGAuss | LPASs | DIRac | ENPShape |
 EWPSshape | LTEFilter | LPASSEVM | APCO25Hcpm |
 APCO25Lsm
 *RST: GAUSSs

Example: See [\[:SOURce<hw>\]:BB:DM:FIlTer:PARAmeter:SPHase](#)
 on page 689

Manual operation: See ["Filter"](#) on page 125

[[:SOURce<hw>]:BB:DM:FIlTer:PARAmeter:APCO25 <Apco25>

[[:SOURce<hw>]:BB:DM:FIlTer:PARAmeter:APCO25Lsm:GAUSSs <Gauss>

[[:SOURce<hw>]:BB:DM:FIlTer:PARAmeter:APCO25Lsm:LOWPass <FiltParm>

[[:SOURce<hw>]:BB:DM:FIlTer:PARAmeter:COSine:BANDwidth <Bandwidth>

[[:SOURce<hw>]:BB:DM:FIlTer:PARAmeter:COSine[:ROLLoff] <Cosine>

[[:SOURce<hw>]:BB:DM:FIlTer:PARAmeter:GAUSSs <Gauss>

[[:SOURce<hw>]:BB:DM:FIlTer:PARAmeter:LPASs <LPass>

[[:SOURce<hw>]:BB:DM:FIlTer:PARAmeter:LPASSEVM <LPassEvm>

[[:SOURce<hw>]:BB:DM:FIlTer:PARAmeter:PGAuss <PGauss>

[[:SOURce<hw>]:BB:DM:FIlTer:PARAmeter:RCOSine <RCosine>

[[:SOURce<hw>]:BB:DM:FIlTer:PARAmeter:SPHase <SPhase>

Sets the filter parameter.

Filter Type	Parameter	Parameter Name	Min	Max	Increment	Default
APCO25	Roll-off factor	<Apco25>	0.05	0.99	0.01	0.2
APCO25Lsm	Cut off frequency for the lowpass/gauss filter (:LOWPass/:GAUSS)	<Cosine>	400	25E6	1E-3	270833.333
COSine	Bandwidth	<FiltParm>	400	depends on the installed options ^{*)}	1E-3	270833.333
COSine	Roll-off factor	<Cosine>	0.05	1	0.01	0.35
GAUSS	Roll-off factor	<Gauss>	0.15	100000	0.01	0.3
LPASS	Cut-off frequency	<LPass>	0.05	2	0.01	0.5
LPASSEVM	Cut-off frequency	<LPassEvm>	0.05	2	0.01	0.5
PGAuss	Roll-off factor	<PGAuss>	0.15	2.5	0.01	0.3
RCOSine	Roll-off factor	<RCosine>	0.05	1	0.001	0.35
SPHase	B x T	<SPHase>	0.15	2.5	0.01	2

^{*)} 100E6 (base unit) / 200E6 (R&S SMBVB-K523) / 300E6 (R&S SMBVB-K524)

Example: SOURce:BB:DM:FILTe:TYPE SPHase
 SOURce:BB:DM:FILTer:PARAMeter:SPHase 0.5

Manual operation: See "[Filter Parameter](#)" on page 125

[:SOURce<hw>] :DM:FILTer:PARAMeter <Parameter>

Sets the filter parameter of the currently selected filter type.

To set the filter type, use command [:SOURce<hw>] :BB:DM:FILTer:TYPE on page 689.

Parameters:

<Parameter>

float

Range: 0.05 to 2.5

Increment: 0.01

*RST: 0.35

Example: see [:SOURce<hw>] :BB:DM:FILTer:PARAMeter:SPHase
 on page 689

Modulation and Coding Settings

[:SOURce<hw>] :BB:DM:CODing <Coding>

Selects the modulation coding.

Parameters:

<Coding> OFF | DIFF | DPHS | DGRay | GRAY | GSM | NADC | PDC | PHS | TETRa | APCO25 | PWT | TFTS | INMarsat | VDL | EDGE | APCO25FSK | ICO | CDMA2000 | WCDMA | APCO258PSK

OFF

The coding is automatically disabled if the selected modulation type is not possible with the coding that has been set

DPHS

Phase Difference

DGRay

Difference + Gray

*RST: GSM

Example: See [Example "Performing general tasks"](#) on page 683

Manual operation: See ["Coding"](#) on page 119

[:SOURce<hw>]:BB:DM:FORMat <Format>

Sets the modulation type.

When a standard is selected ([:SOURce<hw>] :BB:DM:STANdard), the modulation type is set to the default value.

Parameters:

<Format> ASK | BPSK | P2DBpsk | QPSK | QPSK45 | OQPSk | P4QPSk | P4DQpsk | PSK8 | P8D8psk | P8EDge | QAM16 | QAM32 | QAM64 | QAM256 | QAM1024 | MSK | FSK2 | FSK4 | USER | FSKVar | QAM128 | QEDGe | QAM16EDge | QAM32EDge | AQPSk | QAM4096 | APSK16 | APSK32 | FSK32 | FSK64 | FSK8 | FSK16 | QAM512 | QAM2048

*RST: MSK

Example: See [Example "Performing general tasks"](#) on page 683

Manual operation: See ["Modulation Type"](#) on page 122

[:SOURce<hw>]:BB:DM:AQPSk:ANGLE <Angle>

For AQPSK modulation, sets the angle alpha between the point (0,0) and the I axis.

Parameters:

<Angle> float
 Range: 0 to 180
 Increment: 0.01
 *RST: 0
 Default unit: Deg

Example: BB:DM:FORM AQPS
 BB:DM:AQPS:ANGL 45

Manual operation: See ["Angle Alpha"](#) on page 123

[:SOURce<hw>]:BB:DM:ASK:DEPTh <Depth>

Sets the ASK modulation depth for modulation type ASK.

Parameters:

<Depth> float
 Range: 0 to 100
 Increment: 0.1
 *RST: 100
 Default unit: PCT

Example:
 BB:DM:FORM ASK
 BB:DM:ASK:DEPT 50 PCT

Manual operation: See ["ASK Depth"](#) on page 123

[:SOURce<hw>]:BB:DM:FSK:DEVIation <Deviation>

Sets the frequency deviation when FSK modulation is selected.

Parameters:

<Deviation> float
 The value range depends on the symbol rate.
 Range: 1 to 40E6
 Increment: 0.5
 *RST: 135416.5

Example:
 SOURce:BB:DM:FORMat FSK4
 SOURce:BB:DM:FSK:DEVIation 1MHZ

Manual operation: See ["FSK Deviation"](#) on page 123

[:SOURce<hw>]:BB:DM:FSK:VARiable:SYMBol<ch0>:DEVIation <Deviation>

Sets the deviation of the selected symbol for variable FSK modulation mode.

Parameters:

<Deviation> float
 The value range depends on the selected symbol rate (see data sheet).
 Range: -40E6 to 40E6
 Increment: 0.5
 Default unit: Hz

Example:
 SOURce:BB:DM:FORMat FSKVar
 SOURce:BB:DM:FSK:VARiable:TYPE FSK4
 SOURce:BB:DM:FSK:VARiable:SYMBol0:DEVIation 135000

Manual operation: See ["Deviation xxxx"](#) on page 124

[:SOURce<hw>]:BB:DM:FSK:VARiable:TYPE <Type>

The command selects the modulation type for Variable FSK.

Parameters:

<Type> FSK4 | FSK8 | FSK16
 *RST: FSK4

Example: See [:SOURce<hw>]:BB:DM:FSK:VARiable:SYMBOL<ch0>:DEVIation on page 692

Manual operation: See "FSK Type" on page 123

[:SOURce<hw>]:BB:DM:APSK16:GAMMa <Gamma>

Sets the gamma function γ for the 16APSK modulation.

Parameters:

<Gamma> G2D3 | G3D4 | G4D5 | G5D6 | G8D9 | G9D10
 GxDy: G = Gamma function, x_y = code rate
 *RST: G2D3

Example: SOURce1:BB:DM:FORMat APSK16
 SOURce1:BB:DM:APSK16:GAMMa G9D10

Manual operation: See "Gamma/Gamma 1" on page 124

[:SOURce<hw>]:BB:DM:APSK32:GAMMa <Gamma>

Sets the gamma function γ for the 32APSK modulation.

Parameters:

<Gamma> G3D4 | G4D5 | G5D6 | G8D9 | G9D10
 GxDy: G = Gamma function, x_y = code rate
 *RST: G3D4

Example: SOURce1:BB:DM:FORMat APSK32
 SOURce1:BB:DM:APSK32:GAMMa G9D10

Manual operation: See "Gamma/Gamma 1" on page 124

[:SOURce<hw>]:BB:DM:SWITChing:STATe <State>

Enables switching between a modulated and an unmodulated signal.

Parameters:

<State> 0 | 1 | OFF | ON
 *RST: 0

Example: SOURce1:BB:DM:SWITChing:STATe ON

Manual operation: See "State Modulation CW Switching" on page 124

Power Ramping

[:SOURce<hw>]:BB:DM:PRAMP:SOURce <Source>

Sets the source for the power ramp control signals.

Parameters:

<Source> INTernal
 *RST: INTernal

Example: See [Example "Enable power ramping"](#) on page 685

Manual operation: See ["Source"](#) on page 127

[:SOURce<hw>]:BB:DM:PRAMP:SHAPE <Shape>

Sets the edge shape of the ramp envelope.

Parameters:

<Shape> LINear | COSine
 *RST: COSine

Example: See [Example "Enable power ramping"](#) on page 685

Manual operation: See ["Ramp Function"](#) on page 127

[:SOURce<hw>]:BB:DM:PRAMP:TIME <Time>

Sets the power ramping rise time and fall time for a burst.

Parameters:

<Time> float
 Range: 0.25 to 16
 Increment: 0.01
 *RST: 1
 Default unit: symbol

Example: See [Example "Enable power ramping"](#) on page 685

Manual operation: See ["Ramp Time"](#) on page 127

[:SOURce<hw>]:BB:DM:PRAMP:FDElay <FDelay>

[:SOURce<hw>]:BB:DM:PRAMP:RDElay <RDelay>

Sets the delay in the rising edge.

Parameters:

<RDelay> float
 Range: 0 to 4
 Increment: 0.01
 *RST: 0
 Default unit: symbol

Example: See [Example "Enable power ramping"](#) on page 685

Manual operation: See ["Rise Delay"](#) on page 128

[:SOURce<hw>]:BB:DM:PRAMP:ATTenuation <Attenuation>

Sets the level attenuation for signal ranges that are flagged with level attribute *attenuated* by the control signal.

Parameters:

<Attenuation> float
 Range: 0 to 50
 Increment: 0.1
 *RST: 15
 Default unit: dB

Example: See [Example "Enable power ramping"](#) on page 685

Manual operation: See ["Attenuation"](#) on page 128

[:SOURce<hw>]:BB:DM:PRAMP:BBONLY[:STATe] <State>

Enables power ramping in the baseband only or mixed power ramping in the baseband and the RF section.

The ON setting is mandatory if, with power ramping active, only the baseband signal is output (I/Q outputs).

Only then can a signal with a defined, predictable level be output.

Parameters:

<State> 0 | 1 | OFF | ON
 *RST: 0

Example: See [Example "Enable power ramping"](#) on page 685.

Manual operation: See ["In Baseband Only"](#) on page 128

[:SOURce<hw>]:BB:DM:PRAMP[:STATe] <State>

Enables or disables power ramping.

Parameters:

<State> 0 | 1 | OFF | ON
 *RST: 0

Example: See [Example "Enable power ramping"](#) on page 685

Manual operation: See ["State"](#) on page 127

Trigger Settings

[[:SOURce<hw>]:BB:DM[:TRIGger]:SEQUence <Sequence>

Selects the trigger mode. For detailed description of the trigger modes, refer to ["Impact of the Trigger Modes on the Signal Generation"](#) on page 97.

Parameters:

<Sequence> AUTO | RETRigger | AAUTo | ARETrigger | SINGLE
 *RST: AUTO

Example: See [Example "Adjusting clock, marker and trigger settings"](#) on page 684

Manual operation: See ["Mode"](#) on page 110

[[:SOURce<hw>]:BB:DM:TRIGger:SOURce <Source>

Selects the trigger signal source and determines the way the triggering is executed. Provided are:

- Internal triggering by a command (INTernal)
- External trigger signal via one of the User x connectors
 - EGT1: External global trigger
 - EGC1: External global clock
- In master-slave mode, the external baseband synchronization signal (BBSY)
- EXTernal: Setting only
 Provided only for backward compatibility with other Rohde & Schwarz signal generators.
 The R&S SMBV100B accepts this value and maps it automatically as follows:
 EXTernal = EGT1

Parameters:

<Source> INTernal|EGT1|EGC1|EXTernal|BBSY
 *RST: INTernal

Example: See [Example "Adjusting clock, marker and trigger settings"](#) on page 684

Manual operation: See ["Source"](#) on page 111

[[:SOURce<hw>]:BB:DM:TRIGger:SLENgth <SLength>

Defines the length of the signal sequence to be output in the SINGLE trigger mode.

Parameters:

<SLength> integer
 Range: 1 to 4294967295
 *RST: 1000
 Default unit: symbol

Example: See [Example "Adjusting clock, marker and trigger settings"](#) on page 684

Manual operation: See ["Signal Duration"](#) on page 111

[:SOURce<hw>]:BB:DM:TRIGger:RMODE?

Queries the status of signal generation.

Return values:

<RMode> STOP | RUN

Example: SOURce1:BB:DM:TRIGger:SOURce ELTRigger
SOURce1:BB:DM:TRIGger:SEQuence ARETrigger
SOURce1:BB:DM:TRIGger:RMODE?
Response: RUN

Usage: Query only

Manual operation: See ["Running/Stopped"](#) on page 111

[:SOURce<hw>]:BB:DM:TRIGger:EXTernal:SYNChronize:OUTPut <Output>

Enables signal output synchronous to the trigger event.

Parameters:

<Output> 0 | 1 | OFF | ON
*RST: 1

Example: See [Example "Adjusting clock, marker and trigger settings"](#) on page 684

Manual operation: See ["Sync. Output to External Trigger/Sync. Output to Trigger"](#) on page 112

[:SOURce<hw>]:BB:DM:TRIGger:ARM:EXECute

Stops signal generation; a subsequent internal or external trigger event restart signal generation.

Example: See also [Example "Adjusting clock, marker and trigger settings"](#) on page 684

Usage: Event

Manual operation: See ["Arm"](#) on page 111

[:SOURce<hw>]:BB:DM:TRIGger:EXECute

Executes a trigger.

Example: See [Example "Adjusting clock, marker and trigger settings"](#) on page 684

Usage: Event

Manual operation: See ["Execute Trigger"](#) on page 111

[[:SOURce<hw>]:BB:DM:TRIGger:DElay:UNIT <TrigDelUnit>

Determines the units the trigger delay is expressed in.

Parameters:

<TrigDelUnit> SAMPLE | TIME
*RST: SAMPLE

Example: See [Example "Specifying delay and inhibit values in time units"](#) on page 710

Manual operation: See ["\(External\) Delay Unit"](#) on page 112

[[:SOURce<hw>]:BB:DM:TRIGger[:EXtErnal]:DElay <Delay>

Specifies the trigger delay.

Parameters:

<Delay> float
Range: 0 to 2147483647
Increment: 0.01
*RST: 0
Default unit: symbol

Example: See [Example "Adjusting clock, marker and trigger settings"](#) on page 684

Manual operation: See ["\(Specified\) External Delay/\(Specified\) Trigger Delay"](#) on page 113

[[:SOURce<hw>]:BB:DM:TRIGger[:EXtErnal]:TDElay <ExtTimeDelay>

Specifies the trigger delay for external triggering. The value affects all external trigger signals.

Parameters:

<ExtTimeDelay> float
Range: 0 to 7929.170398682
Increment: 0.25E-9
*RST: 0
Default unit: s

Example: See [Example "Specifying delay and inhibit values in time units"](#) on page 710

Manual operation: See ["\(Specified\) External Delay/\(Specified\) Trigger Delay"](#) on page 113

[[:SOURce<hw>]:BB:DM:TRIGger[:EXTernal]:RDElay?

Queries the time (in seconds) an external trigger event is delayed for.

Return values:

<ResTimeDelaySec> float
 Range: 0 to 688
 Increment: 0.25E-9
 *RST: 0

Example: See [Example "Specifying delay and inhibit values in time units"](#) on page 710

Usage: Query only

Manual operation: See ["Actual Trigger Delay/Actual External Delay"](#) on page 113

[[:SOURce<hw>]:BB:DM:TRIGger[:EXTernal]:INHibit <Inhibit>

Specifies the number of symbols by which a restart is inhibited.

Parameters:

<Inhibit> integer
 Range: 0 to 21.47*symbRate
 *RST: 0
 Default unit: symbol

Example: See [Example "Adjusting clock, marker and trigger settings"](#) on page 684

Manual operation: See ["External / Trigger Inhibit"](#) on page 112

Marker Settings**[[:SOURce<hw>]:BB:DM:TRIGger:OUTPut<ch>:MODE <Mode>**

Defines the signal for the selected marker output.

For detailed description of the regular marker modes, refer to ["Marker Modes"](#) on page 94.

Parameters:

<Mode> CLISt | PULSe | PATTeRn | RATIo

CLISt

A marker signal that is defined in the selected control list is generated.

*RST: RATIo

Example: See [Example "Adjusting clock, marker and trigger settings"](#) on page 684

Manual operation: See ["Marker Mode"](#) on page 114

```
[:SOURce<hw>]:BB:DM:TRIGger:OUTPut<ch>:ONTime <OnTime>
```

```
[:SOURce<hw>]:BB:DM:TRIGger:OUTPut<ch>:OFFTime <OffTime>
```

Sets the number of symbols in a period (ON time + OFF time) for marker `RATio`.

Parameters:

```
<OffTime>          integer
                    Range:    1 to 16777215
                    *RST:    1
                    Default unit: symbol
```

Example: See [Example "Adjusting clock, marker and trigger settings"](#) on page 684

Manual operation: See ["Marker Mode"](#) on page 114

```
[:SOURce<hw>]:BB:DM:TRIGger:OUTPut<ch>:PATTern <Pattern>, <BitCount>
```

Defines the bit pattern used to generate the marker signal.

Parameters:

```
<Pattern>          numeric
                    *RST:    #H2

<BitCount>        integer
                    0 = marker off, 1 = marker on
                    Range:    1 to 64
                    *RST:    2
```

Example: See [Example "Adjusting clock, marker and trigger settings"](#) on page 684.

Manual operation: See ["Marker Mode"](#) on page 114

```
[:SOURce<hw>]:BB:DM:TRIGger:OUTPut<ch>:PULSe:DIVider <Divider>
```

Sets the divider for pulse marker mode (`PULSe`).

Parameters:

```
<Divider>         integer
                    Range:    2 to 1024
                    *RST:    2
```

Example: See [Example "Adjusting clock, marker and trigger settings"](#) on page 684

Manual operation: See ["Marker Mode"](#) on page 114

```
[:SOURce<hw>]:BB:DM:TRIGger:OUTPut<ch>:PULSe:FREQuency?
```

Queries the pulse frequency of the pulsed marker signal `PULSe`.

Return values:

<Frequency> float

Example: See [Example "Adjusting clock, marker and trigger settings"](#) on page 684**Usage:** Query only**Manual operation:** See ["Marker Mode"](#) on page 114**[:SOURce<hw>]:BB:DM:TRIGger:OUTPut<ch>:DELay <Delay>**

Defines the delay between the signal on the marker outputs and the start of the signal, expressed in terms of symbols.

Parameters:

<Delay> float
 Range: 0 to 16777215
 Increment: 0.001
 *RST: 0

Example: See [Example "Adjusting clock, marker and trigger settings"](#) on page 684**Manual operation:** See ["Marker x Delay"](#) on page 114**Clock Settings****[:SOURce<hw>]:BB:DM:CLOCK:SOURce <Source>**

Selects the clock source:

- INTernal: Internal clock reference

Parameters:

<Source> INTernal
 *RST: INTernal

Example: See [Example "Adjusting clock, marker and trigger settings"](#) on page 684.**Manual operation:** See ["Clock Source"](#) on page 115**Handling List Files****[:SOURce<hw>]:BB:DM:CLISt:CATalog?****[:SOURce<hw>]:BB:DM:FLISt:CATalog?****[:SOURce<hw>]:BB:DM:MLISt:CATalog?****[:SOURce<hw>]:BB:DM:DLISt:CATalog?**Reads out the list files present in the default directory (see [:MMEMory:CDIRectory](#)).

List type	Command	File extension
Data list	...:DLISt...	*.dm_iqd
Control list	...:CLISt...	*.dm_iqc
User filter files	...:FLISt...	*.vaf
User mapping lists	...:MLISt...	*.vam

Refer to [Chapter 12.6.2, "Accessing Files in the Default or in a Specified Directory"](#), on page 588 for general information on file handling in the default and a specific directory.

Return values:

<Catalog> "<filename1>,<filename2>,..."
Returns a string of file names separated by commas.

Example: See [Example "Performing general tasks"](#) on page 683.

Usage: Query only

Manual operation: See ["Data Source"](#) on page 120

[SOURce<hw>]:BB:DM:CLISt:SElect <Filename>

[SOURce<hw>]:BB:DM:FLISt:SElect <Filename>

[SOURce<hw>]:BB:DM:MLISt:SElect <Filename>

[SOURce<hw>]:BB:DM:DLISt:SElect <Select>

Selects the specified list file from the default directory (see :MMEMory:CDIRectory) or in the directory specified with the absolute file path.

If a list with the specified name does not yet exist, it is created. The file extension can be omitted.

Refer to [Chapter 12.6.2, "Accessing Files in the Default or in a Specified Directory"](#), on page 588 for general information on file handling in the default and a specific directory.

List type	Command	File extension
Data list	...:DLISt...	*.dm_iqd
Control list	...:CLISt...	*.dm_iqc
User standard	...:ULISt...	*.dm_stu
User filter files	...:FLISt...	*.vaf
User mapping lists	...:MLISt...	*.vam

Parameters:

<Select> <list name>

Example: See [Example "Performing general tasks"](#) on page 683

Manual operation: See ["Data Source"](#) on page 120

[:SOURce<hw>]:BB:DM:CLIST:DELeTe <Filename>
 [:SOURce<hw>]:BB:DM:FLIST:DELeTe <Filename>
 [:SOURce<hw>]:BB:DM:MLIST:DELeTe <Filename>
 [:SOURce<hw>]:BB:DM:DLIST:DELeTe <Filename>

Deletes the specified list from the default directory (see :MMEMory:CDIRectory) or from the directory specified with the absolute file path.

Refer to [Chapter 12.6.2, "Accessing Files in the Default or in a Specified Directory"](#), on page 588 for general information on file handling in the default and a specific directory.

List type	Command	File extension
Data list	...:DLIST...	*.dm_iqd
Control list	...:CLIST...	*.dm_iqc
User standard	...:ULIST...	*.dm_stu
User filter files	...:FLIST...	*.vaf
User mapping lists	...:MLIST...	*.vam

Setting parameters:

<Filename> string

Example: See [Example "Performing general tasks"](#) on page 683

Usage: Setting only

Manual operation: See ["Select Data List"](#) on page 121

[:SOURce<hw>]:BB:DM:CLIST:FREE?
 [:SOURce<hw>]:BB:DM:FLIST:FREE?
 [:SOURce<hw>]:BB:DM:MLIST:FREE?
 [:SOURce<hw>]:BB:DM:DLIST:FREE?

Queries the list free memory.

List type	Command	File extension
Data list	...:DLIST...	*.dm_iqd
Control list	...:CLIST...	*.dm_iqc
User filter files	...:FLIST...	*.vaf
User mapping lists	...:MLIST...	*.vam

Return values:

<Free> integer
 Range: 0 to INT_MAX
 *RST: 0

Example: See [Example "Performing general tasks"](#) on page 683

Usage: Query only

[:SOURce<hw>]:BB:DM:CLIST:POINTS?

Queries the number of lines (2 bytes) in the currently selected list.

Return values:

<Points> integer
 Range: 0 to INT_MAX
 *RST: 0

Example:

```
SOURce:BB:DM:CLIST:SElect "c_list"
SOURce:BB:DM:CLIST:POINTS?
// 20
// the control list consists of 20 lines
```

Usage: Query only

[:SOURce<hw>]:BB:DM:DLIST:POINTS <Points>

Defines the number of bits in the selected data list to be utilized. When a list is being filled with block data, this data is only ever sent in multiples of 8 bits. However the exact number of bits to be exploited can be set to a different figure. The superfluous bits in the list are then ignored.

Parameters:

<Points> integer
 Range: 0 to INT_MAX
 *RST: 0

Example:

```
SOURce:BB:DM:DLIST:POINTS 234
```

Defines the number of bits in the data list to be utilized as 234 bits. If the list was filled with block data, at least the last 6 bits are ignored.

[:SOURce<hw>]:BB:DM:FLIST:POINTS?

[:SOURce<hw>]:BB:DM:MLIST:POINTS?

Queries the user modulation mapping/user filter list length.

Return values:

<Points> integer
 Range: max
 *RST: 0

Example:

```
BB:DM:FORM USER
BB:DM:MLIST:POIN?
```

Usage: Query only

[[:SOURce<hw>]:BB:DM:CLIST:COPY <Filename>

[[:SOURce<hw>]:BB:DM:DLIST:COPY <Filename>

Copies the selected data list (*.dm_iqd)/ control list (*.dm_iqc) as a new list with name specified by <Filename>. If a list with the specified name exists, it is overwritten. If it does not yet exist, it is created.

The source file has to be available in the default directory (see :MMEMory:CDIRectory).

Refer to [Chapter 12.6.2, "Accessing Files in the Default or in a Specified Directory"](#), on page 588 for general information on file handling in the default and a specific directory.

Setting parameters:

<Filename> string

Example: See [Example "Performing general tasks"](#) on page 683

Usage: Setting only

Manual operation: See ["Select Data List"](#) on page 121

[[:SOURce<hw>]:BB:DM:CLIST:DATA <Data>

Sends the data to the currently selected control list. If the list already contains data, it is *overwritten*. This command only writes data into the data section of the file.

The values for the control signals are sent, arranged in an 8-bit value as defined in [Table 12-1](#).

Table 12-1: Contents of a control lists

Signal	Order	Decimal value of bits
Marker 1	LSB	1
Marker 2		2
Marker 3		4
Marker 4		8
Burst	LSB	16
LevAtt1	LSB	32
CWMod	LSB	64
Hop	MSB	128

The data can also be sent as a binary block, each binary block being a 2-byte value in which the 16 bits represent the binary values (16-bit unsigned integer, 2 bytes, LSB first).

When binary data transmission is in use, use the command :SYSTem:COMMunicate:GPIB:LTERminator EOI to set the termination character mode to 'EOI control data message only' so that a random LF in the data sequence is not interpreted as End, thereby prematurely terminating the data transmission. The command :LTER STAN resets the mode.

According to the specifications, the byte sequence is defined as 'most significant byte first'.

Tip: Control lists are created in binary format. You may however need the control list in an ASCII format, e.g for creating a waveform file with R&S WinIQSIM2. Refer to the example in "[How to Create a Control List Using Tag File Format](#)" on page 767 for description on how to create a control list file in ASCII format manually.

*RST has no effect on data lists.

Setting parameters:

<Data> string

Example:

```
MMEMory:CDirectory "/var/user/clists"
SOURce1:BB:DM:CLIST:SElect "clist_marker3"
SOURce1:BB:DM:CLIST:DATA 0,0,0,0,8,8,8,0,0,0,0...
// Enters the control values in the selected list
// In the example, only ramps for Marker 3 are set.
```

Usage: Setting only

Manual operation: See "[Select Ramp to Edit](#)" on page 132

[:SOURce<hw>]:BB:DM:DLIST:DATA <Data>
[:SOURce<hw>]:BB:DM:DLIST:DATA? [<Start>[, <Count>]]

The **Setting** command sends the bit data to the selected data list. Any existing content in the list is *overwritten*. This command only writes data into the data section of the file.

Data can be sent as block data in binary or packet format (:FORMat ASCii | PACKed), each byte being interpreted as 8 data bits.

When binary data transmission is in use, use the command :SYSTem:COMMunicate:GPIB:LTERminator EOI to set the termination character mode to 'EOI control data message only' so that a random LF in the data sequence is not interpreted as End, thereby prematurely terminating the data transmission. The command . . .LTER STAN resets the mode.

According to the specifications, the byte sequence is defined as 'most significant byte first'.

The **query** reads out the data part of the list file. If the query is expanded by using the two parameters <Start> and <Count>, the list is read out in smaller sections. Without the parameters the total length is always read out starting from address 1.

*RST has no effect on data lists.

Parameters:

<Data> integer
 bit data

Query parameters:

<Start> integer
 Range: 1 to 2147483647

<Count> integer
Range: 1 to 2147483647

Example: See [Example "Performing general tasks"](#) on page 683

[:SOURce<hw>]:BB:DM:DLIST:DATA:APPend <Bits>

Appends the bit data onto the end of the existing data in the selected data list. Existing content in the data list is not overwritten. Hence, you can create long data lists piece-meal.

The command cannot be used with an empty data list, like for example data lists that has just been created. Use the command `[:SOURce<hw>]:BB:DM:DLIST:DATA` first and enter modulation data in the list.

*RST has no effect on data lists.

Setting parameters:

<Bits> 0 | 1 { 0 | 1 } | block data

Example: See [Example "Performing general tasks"](#) on page 683

Usage: Setting only

[:SOURce<hw>]:BB:DM:CLIST:TAG?

[:SOURce<hw>]:BB:DM:DLIST:TAG?

Queries the content of the specified tag in the selected file.

Return values:

<Tag> <control list>, <tag name>

Refer to ["Tag Description"](#) on page 750 for description of the available tag formats.

Example: `SOURce1:BB:DM:DLIST:TAG? "D_list", "date"`
Queries the Date tag in list D_list.

Usage: Query only

12.16.4.3 SOURce:BB:ARbitrary Subsystem

This section list the commands of the `SOURce:BB:ARbitrary` subsystem.

Required options

See [Chapter 3.6.1, "Required Options"](#), on page 145.

The commands are grouped in the following sections:

- [Programming Examples](#).....708
- [General Commands](#).....716
- [Test Signal Commands](#).....717
- [Waveform Commands](#).....720
- [Multi-Segment Commands](#).....724

• Multi-Segment Sequencing Commands.....	729
• Multi-Carrier Commands.....	732
• Trigger Commands.....	744
• Marker Commands.....	747
• Clock Commands.....	749

Programming Examples

Example: Creating test signals

The following example lists commands necessary to configure the different test signals.

```
// *****
// Reset instrument first
// *****
*RST; *CLS
SOURce:BB:ARbitrary:PRESet

// *****
// Create test signals
// *****
SOURce:BB:ARbitrary:SIGNal:TYPE CIQ
SOURce:BB:ARbitrary:TSIGNal:CIQ:I -0.5
SOURce:BB:ARbitrary:TSIGNal:CIQ:Q -0.33
SOURce:BB:ARbitrary:TSIGNal:CIQ:CREate

SOURce:BB:ARbitrary:TSIGNal:SINE:FREQuency 1MHz
SOURce:BB:ARbitrary:TSIGNal:SINE:SAMPles 100
SOURce:BB:ARbitrary:TSIGNal:SINE:PHASe -90
SOURce:BB:ARbitrary:TSIGNal:SINE:CREate:NAMEd "/var/user/ARBtestSignals/sineTest"

SOURce:BB:ARbitrary:TSIGNal:RECTangle:FREQuency 100KHz
SOURce:BB:ARbitrary:TSIGNal:RECTangle:SAMPles 1000
SOURce:BB:ARbitrary:TSIGNal:RECTangle:AMPLitude 0.5
SOURce:BB:ARbitrary:TSIGNal:RECTangle:OFFSet -0.3
SOURce:BB:ARbitrary:TSIGNal:RECTangle:CREate:NAMEd "/var/user/ARBtestSignals/rectTest"

SOURce:ARbitrary:STATe ON
```

Example: Managing waveform files

The following example lists the commands provided for handling of waveform files.

```
// *****
// Reset instrument first
// *****
*RST; *CLS
SOURce:BB:ARbitrary:PRESet

// *****
```

```

// Set the default directory and list the available waveform files
// *****
MME:CDIR "/var/user/ARBtestSigs"
SOURce:BB:ARBitrary:WAVeform:CATalog?
// sineTest,rectTest,ciqTestSignal,waveformTest,test2
SOURce:BB:ARBitrary:WAVeform:CATalog:LENGth?
// 5
// SOURce:BB:ARBitrary:WAVeform:FREE?

// *****
// Select a waveform and query information
// *****
// SOURce:BB:ARBitrary:WAVeform:DELeTe "/var/user/ARBtestSigs/test2"
SOURce:BB:ARBitrary:WAVeform:SELeCt "/var/user/ARBtestSigs/wvTest"
SOURce:BB:ARBitrary:WAVeform:POINts?
// 100
SOURce:BB:ARBitrary:WAVeform:TAG? "TYPE"
// "SMU-WV"
SOURce:BB:ARBitrary:WAVeform:TAG? "COMMENT"
// "Waveform for test purposes"
// alternatively: query the comment tag of the current waveform file
// SOURce:BB:ARBitrary:WAVeform:DATA? "comment"
// "Waveform for test purposes"

// to query the date tag of a specific waveform file
// SOURce:BB:ARBitrary:WAVeform:DATA? "/var/user/ARBtestSigs/waveformTest","date"
// #2192014-04-15;16:19:30

// *****
// Clock settings
// *****
SOURce:BB:ARBitrary:CLOCK:SOURce INTernal
SOURce:BB:ARBitrary:CLOCK?
// 10000000
// or alternatively use SOURce:BB:ARBitrary:WAVeform:TAG? "CLOCK"

// *****
// Configure and enable standard marker signals
// *****
SOURce:BB:ARBitrary:TRIGger:OUTPut1:MODE REStart
SOURce:BB:ARBitrary:TRIGger:OUTPut2:MODE PULSe
SOURce:BB:ARBitrary:TRIGger:OUTPut2:PULSe:DIVider 5
SOURce:BB:ARBitrary:TRIGger:OUTPut2:PULSe:FREQuency?
// 2000000
SOURce:BB:ARBitrary:TRIGger:OUTPut3:MODE PATtern
SOURce:BB:ARBitrary:TRIGger:OUTPut3:PATtern #HE0F52,20
SOURce:BB:ARBitrary:TRIGger:OUTPut1:MODE RATio
SOURce:BB:ARBitrary:TRIGger:OUTPut1:ONTime 40
SOURce:BB:ARBitrary:TRIGger:OUTPut1:OFFTime 20

```

```

SOURce:BB:ARbitrary:TRIGger:OUTPut2:DElay 16

// *****
// Configure and enable signal triggering; start ARB generator
// *****
SOURce:BB:ARbitrary:TRIGger:SEquence SINGLE
SOURce:BB:ARbitrary:TRIGger:SLenGth 200
// the first 200 samples of the current waveform will be output after
// the next trigger event
// SOURce:BB:ARbitrary:TRIGger:SEquence ARETrigger
// SOURce:BB:ARbitrary:TRIGger:SOURce EGT1
// external trigger signal must be provided at the USER connector
SOURce:BB:ARbitrary:TRIGger:EXternal:SYNChronize:OUTPut ON
SOURce:BB:ARbitrary:TRIGger:EXternal:DElay 200
SOURce:BB:ARbitrary:TRIGger:EXternal:INHibit 100

// with internal trigger source
SOURce:BB:ARbitrary:TRIGger:SEquence AAUTO
SOURce:BB:ARbitrary:TRIGger:SOURce INTernal
SOURce:BB:ARbitrary:STAT ON
SOURce:BB:ARbitrary:TRIGger:EXEC

```

Example: Specifying delay and inhibit values in time units

The following example lists the commands necessary to configure the instrument as described in "Specifying delay and inhibit values in time units" on page 102.

```

SOURcel:BB:ARbitrary:CLOCK 1000000
SOURcel:BB:ARbitrary:TRIGger:SEquence AAUT
SOURcel:BB:ARbitrary:TRIGger:SOURce EGT1
SOURcel:BB:ARbitrary:TRIGger:DElay:UNIT SAMP
SOURcel:BB:ARbitrary:TRIGger:EXternal:DElay 100
SOURcel:BB:ARbitrary:TRIGger:EXternal:RDElay?
// Response: 100

SOURcel:BB:ARbitrary:TRIGger:DElay:UNIT TIME
SOURcel:BB:ARbitrary:TRIGger:EXternal:TDElay 0.00001
SOURcel:BB:ARbitrary:TRIGger:EXternal:RDElay?
// Response: 0.00001

SOURcel:BB:ARbitrary:TRIGger:DElay:UNIT SAMP
SOURcel:BB:ARbitrary:TRIGger:EXternal:DElay 10

```

Example: Creating a multi-segment waveform

The following example lists the commands necessary to create a multi-segment waveform.

```

// *****
// Reset instrument first
// *****

```

```

*RST; *CLS
// SOURce:BB:ARBitrary:PRESet

// *****
// Set the default directory and list the available waveform files
// *****
MMEM:CDIR "/var/user/ARB/multi_segment"
SOURce:BB:ARBitrary:WAVeform:CATalog:LENGth?
// 4
SOURce:BB:ARBitrary:WAVeform:CATalog?
// Seg_0, Seg_1, Seg_2, Seg_3
// *****
// List the available configuration files and select/create file
// *****
SOURce:BB:ARBitrary:WSEGment:CONFigure:CATalog?
// multi_segment,ms_waveform
// the directory contains the configuration files multi_segment.inf_mswv
and ms_waveform.inf_mswv
SOURce:BB:ARBitrary:WSEGment:CONFigure:DELeTe "ms_waveform.inf_mswv"
SOURce:BB:ARBitrary:WSEGment:CONFigure:SELeCt
"/var/user/ARB/multi_segment/config.inf_mswv"
// creates new empty configuration file config.inf_mswv

// *****
// Append waveforms to the multi segment sequence
// *****
SOURce:BB:ARBitrary:WSEGment:CONFigure:SEGment:APPend "Seg_0"
// Waveform Seg_0.wv will be the first segment of a
// multi segment waveform created with configuration file config.inf_mswv
SOURce:BB:ARBitrary:WSEGment:CONFigure:SEGment:APPend "Seg_1"
SOURce:BB:ARBitrary:WSEGment:CONFigure:SEGment:APPend "Seg_2"
SOURce:BB:ARBitrary:WSEGment:CONFigure:SEGment:APPend "Seg_3"

SOURce:BB:ARBitrary:WSEGment:CONFigure:BLAnk:APPend 1000,100000000
// adds a blank segment with 1000 samples and 100 MHz clock rate

SOURce:BB:ARBitrary:WSEGment:CONFigure:LEVel:MODE ERMS
SOURce:BB:ARBitrary:WSEGment:CONFigure:CLOCk:MODE HIGHest
// SOURce:BB:ARBitrary:WSEGment:CONFigure:CLOCk:MODE USER
// SOURce:BB:ARBitrary:WSEGment:CONFigure:CLOCk 30000000
SOURce:BB:ARBitrary:WSEGment:CONFigure:MARkEr:MODE TAKE

SOURce:BB:ARBitrary:WSEGment:CONFigure:SELeCt
"/var/user/ARB/multi_segment/config.inf_mswv"
SOURce:BB:ARBitrary:WSEGment:CONFigure:COMMEnt "Multi Segment File"
SOURce:BB:ARBitrary:WSEGment:CONFigure:OFILe "ms_0to3"
SOURce:BB:ARBitrary:WSEGment:CONFigure:SEGment:CATalog?
// /var/user/ARB/multi_segment/Seg_0.wv,/var/user/ARB/multi_segment/Seg_1.wv,
// /var/user/ARB/multi_segment/Seg_2.wv,/var/user/ARB/multi_segment/Seg_3.wv

```

```
// *****
// Create and load the waveforms into the ARB generator; the ARB is activated
// the first segment is output depending on the trigger settings
// *****
// SOURce:BB:ARbitrary:WSEgment:CREate "/var/user/ARB/multi_segment/config.inf_mswv"
SOURce:BB:ARbitrary:WSEgment:CLOad "/var/user/ARB/multi_segment/config.inf_mswv"

SOURce:BB:ARbitrary:TRIGger:SEQuence AAUTO
SOURce:BB:ARbitrary:TRIGger:SOURce INTernal
SOURce:BB:ARbitrary:STAT ON
SOURce:BB:ARbitrary:TRIGger:EXEC
```

Example: Configuring the output order of the segments

The following example lists the commands necessary to trigger the output of the segments in desired playback order. The example lists only the relevant commands.

We assume, that the multi-segment sequence `ms_0to3` composed of four segments, `Seg_0`, `Seg_1`, `Seg_2` and `Seg_3` is created and loaded in the ARB (see [Example "Creating a multi-segment waveform"](#) on page 710). The required output order of the segments is `Seg_0`, `Seg_3 [2]`, `Seg_2`.

```
// *****
// Select a multi segment waveform
// *****
MMEM:CDIR "/var/user/ARB/multi_segment"
SOURce:BB:ARbitrary:WSEgment:CONFigure:CATalog?
// config
SOURce:BB:ARbitrary:WSEgment:CONFigure:SElect "config"
SOURce:BB:ARbitrary:WSEgment:CONFigure:OFILe?
// "/var/user/ARB/multi_segment/ms_0to3"
SOURce:BB:ARbitrary:WSEgment:CLOad "/var/user/ARB/multi_segment/config.inf_mswv"

// *****
// Adjust trigger settings and enable the ARB
// *****
SOURce:BB:ARbitrary:TRIGger:SEQuence AAUTO
SOURce:BB:ARbitrary:TRIGger:SOURce INTernal
SOURce:BB:ARbitrary:STATe ON

// *****
// Select the next segment trigger mode and source
// *****
SOURce:BB:ARbitrary:TRIGger:SMODE NEXT
// SOURce:BB:ARbitrary:TRIGger:SMODE NSEam
SOURce:BB:ARbitrary:WSEgment:NEXT:SOURce INTernal

SOURce:BB:ARbitrary:WSEgment?
// 0
SOURce:BB:ARbitrary:WSEgment:NAME?
// "/var/user/ARB/multi_segment/Seg_0.wv"
```

```

// Seg_0 is output continuously

// *****
// Trigger a switch over to the next segment
// *****
SOURce:BB:ARbitrary:WSEgment:NEXT 3
// stops Seg_0 and starts immediatly Seg_3; Seg_3 is output continuously
SOURce:BB:ARbitrary:TRIGger:EXECute
//restarts Seg_3
SOURce:BB:ARbitrary:WSEgment:NEXT 2
SOURce:BB:ARbitrary:WSEgment:NEXT 0

// *****
// Scrolling trough the segments, i.e. shwitch over in incremental order
// *****
SOURce:BB:ARbitrary:WSEgment:NEXT:EXECute
SOURce:BB:ARbitrary:WSEgment?
// 1
SOURce:BB:ARbitrary:WSEgment:NEXT:EXECute
SOURce:BB:ARbitrary:WSEgment?
// 2

```



Refer to "To apply a manual segment switch to the output segments in the required order" on page 190 for description of the steps necessary to achieve a similar task via manual operation of the instrument.

Example: Using the ARB sequencer

The following example lists the commands necessary to configure a play list. The example lists only the relevant commands.

We assume, that the multi-segment sequence `ms_0to3` composed of four segments, `Seg_0`, `Seg_1`, `Seg_2` and `Seg_3` is created and loaded in the ARB (see [Example "Creating a multi-segment waveform"](#) on page 710). The required output order of the segments is `Seg_0`, `Seg_3 [2]`, `Seg_2`.



The ARB Sequencer mode requires waveform files with equal clock rate!

```

// *****
// Select a multi segment waveform composed from waveforms with equal clock rates
// *****
MMEM:CDIR "/var/user/ARB/multi_segment"
SOURce:BB:ARbitrary:WSEgment:CONFigure:CATalog?
// config
SOURce:BB:ARbitrary:WSEgment:CONFigure:SElect "config"
SOURce:BB:ARbitrary:WSEgment:CLOad "/var/user/ARB/multi_segment/config.inf_mswv"
SOURce:BB:ARbitrary:WSEgment:CONFigure:OFILe?
// "/var/user/ARB/multi_segment/ms_0to3.wv"

```



```
// *****
// Select a sequencing list (*.wvs)
// *****
SOURce:BB:ARbitrary:WSEgment:SEquence:SElect "play_list"
SOURce:BB:ARbitrary:WSEgment:SEquence:APPend ON,0,1,NEXT
// adds the segment number 0 as a new (first) segment in the sequencing list
// this segment is activ and will be repeated once followed by the next segment
SOURce:BB:ARbitrary:WSEgment:SEquence:APPend ON,3,2,NEXT
SOURce:BB:ARbitrary:WSEgment:SEquence:APPend ON,2,1,SEG0

SOURce:BB:ARbitrary:TRIGger:SMODE SEQuencer
SOURce:BB:ARbitrary:TRIGger:SEquence AAUTO
SOURce:BB:ARbitrary:TRIGger:SOURce INTernal
SOURce:BB:ARbitrary:STAT ON
SOURce:BB:ARbitrary:TRIGger:EXEC
```



Refer to ["To apply a manual segment switch to the output segments in the required order"](#) on page 190 for description of the steps necessary to achieve a similar task via manual operation of the instrument.

Example: Adding extra marker signals

The following example lists the commands necessary to add two marker signals, a sequence restart marker and a segment restart marker, to the multi-segment sequence. The example lists only the relevant commands.

```
// *****
// Select the multi segment file and the corresponding configuration list
// *****
MMEM:CDIR "/var/lists/ARB/multi_segment"
SOURce:BB:ARbitrary:WSEgment:CONFigure:CATalog?
// config
SOURce:BB:ARbitrary:WSEgment:CONFigure:SElect "config"
SOURce:BB:ARbitrary:WSEgment:CLOad "/var/user/ARB/multi_segment/config.inf_mswv"
SOURce:BB:ARbitrary:WSEgment:CONFigure:OFILe?
// "/var/user/ARB/multi_segment/ms_0to3.wv"

// *****
// Enable restart markers on marker trace 1 and 2
// *****
SOURce:BB:ARbitrary:WSEgment:CONFigure:MARKer:MODE IGNore
SOURce:BB:ARbitrary:WSEgment:CONFigure:MARKer:FSEgment MRK1
SOURce:BB:ARbitrary:WSEgment:CONFigure:MARKer:ESEgment MRK2

SOURce:BB:ARbitrary:TRIGger:OUTPut1:MODE UNCHanged
SOURce:BB:ARbitrary:TRIGger:OUTPut2:MODE UNCHanged
```

Example: Generating a multi carrier signal

The following example lists the commands necessary to generate a multi carrier signal.

```
// *****
// Generating a multi carrier signal
// *****
// Load a standardized 3GPP downlink test model, e.g. "Test Model 1 16 Channels"
SOURcel:BB:W3Gpp:SETTing:TMODeL:BSTation "Test_Model_1_16channels"
// Confirm that the standardized 3GPP downlink test model is currently selected
SOURcel:BB:W3Gpp:SETTing:TMODeL:BSTation?
// "Test_Model_1_16channels"
// Enable the generation of 3GPP FDD signal
SOURcel:BB:W3Gpp:STATe ON
// Generate a 3GPP FDD ARB waveform file with name "3gpp_arb"
// store the waveform in the default directory ("/var/user")
SOURcel:BB:W3Gpp:WAVEform:CREate "3gpp_arb"

// *****
// Configure a multi carrier scenario with 4 carriers
// and carrier spacing of 5 MHz
// Activate the carriers
// *****
SOURcel:BB:ARBitrary:MCARrier:CARRier:COUNT 4
SOURcel:BB:ARBitrary:MCARrier:CARRier:SPACing 5 MHz
SOURcel:BB:ARBitrary:MCARrier:CARRier1:STATe ON
SOURcel:BB:ARBitrary:MCARrier:CARRier2:STATe ON
SOURcel:BB:ARBitrary:MCARrier:CARRier3:STATe ON
SOURcel:BB:ARBitrary:MCARrier:CARRier4:STATe ON

// *****
// Select and load the waveform file "3gpp_arb" to all 4 carriers
// (the file "3gpp_arb" is in default directory)
// *****
SOURcel:BB:ARBitrary:MCARrier:CARRier1:FILE "3gpp_arb"
SOURcel:BB:ARBitrary:MCARrier:CARRier2:FILE "3gpp_arb"
SOURcel:BB:ARBitrary:MCARrier:CARRier3:FILE "3gpp_arb"
SOURcel:BB:ARBitrary:MCARrier:CARRier4:FILE "3gpp_arb"

// *****
// Trigger the signal caulation and load the waveform in the ARB generator
// *****
// Define the file name of the multi carrier output file, e.g. "3gpp_mc"
SOURcel:BB:ARBitrary:MCARrier:OFIle "3gpp_mc"
// Create and load the multi carrier waveform file in the ARB generator
SOURcel:BB:ARBitrary:MCARrier:CLoad
// Alternatively: create the multi carrier waveform and
// load it subsequently in the ARB generator
// SOURcel:BB:ARBitrary:MCARrier:CREate
// SOURcel:BB:ARBitrary:WAVEform:SELEct"3gpp_mc"
```

```
// Activate the ARB generator
SOURce1:BB:ARbitrary:STATE ON

// *****
// Use the save/recall function to store the settings
// *****
// Query available settings files in a specified directory
MMEM:CDIR "/var/user/waveform"
SOURce1:BB:ARbitrary:MCARrier:SETTING:CATalog?
// mcar1, mcar2
// the directory contains the settings files mcar1.arb_multcarr and mcar2.arb_multcarr
SOURce1:BB:ARbitrary:MCARrier:SETTING:STORE "3gpp_mc"
```

General Commands

[SOURce<hw>]:BB:ARbitrary:PRESet

Sets all ARB generator parameters to their default values.

Example: See ["Programming Examples"](#) on page 708

Usage: Event

Manual operation: See ["Set To Default"](#) on page 152

[SOURce<hw>]:BB:ARbitrary:STATE <State>

Enables the ARB generator.

A waveform must be selected before the ARB generator is activated.

Parameters:

<State> 0 | 1 | OFF | ON
*RST: 0

Example: See ["Programming Examples"](#) on page 708

Manual operation: See ["State"](#) on page 151

[SOURce<hw>]:BB:ARbitrary:PRAMP[:STATE] <ArbPramState>

If activated, the burst gate marker signal included in the ARB waveform file is used as marker signal for the pulse modulator.

Parameters:

<ArbPramState> 0 | 1 | OFF | ON
*RST: 0

Example:

```
SOURce1:BB:ARbitrary:WAVEform:SElect "/var/user/Pulse_PMod_Burst"
SOURce1:BB:ARbitrary:PRAMP:STATE 1
SOURce1:BB:ARbitrary:STATE 1
```

Options: R&S SMBVB-K22

Manual operation: See "RF Power Ramping with Burst Marker" on page 154

Test Signal Commands

<code>[:SOURce<hw>]:BB:ARbitrary:SIGNal:TYPE</code>	717
<code>[:SOURce<hw>]:BB:ARbitrary:TSIGNal:CIQ:I</code>	717
<code>[:SOURce<hw>]:BB:ARbitrary:TSIGNal:CIQ:Q</code>	717
<code>[:SOURce<hw>]:BB:ARbitrary:TSIGNal:RECTangle:AMPLitude</code>	717
<code>[:SOURce<hw>]:BB:ARbitrary:TSIGNal:RECTangle:FREQuency</code>	718
<code>[:SOURce<hw>]:BB:ARbitrary:TSIGNal:RECTangle:OFFSet</code>	718
<code>[:SOURce<hw>]:BB:ARbitrary:TSIGNal:RECTangle:SAMPles</code>	718
<code>[:SOURce<hw>]:BB:ARbitrary:TSIGNal:SINE:FREQuency</code>	719
<code>[:SOURce<hw>]:BB:ARbitrary:TSIGNal:SINE:PHASe</code>	719
<code>[:SOURce<hw>]:BB:ARbitrary:TSIGNal:SINE:SAMPles</code>	719
<code>[:SOURce<hw>]:BB:ARbitrary:TSIGNal:CIQ:CREate:NAMed</code>	720
<code>[:SOURce<hw>]:BB:ARbitrary:TSIGNal:RECTangle:CREate:NAMed</code>	720
<code>[:SOURce<hw>]:BB:ARbitrary:TSIGNal:SINE:CREate:NAMed</code>	720
<code>[:SOURce<hw>]:BB:ARbitrary:TSIGNal:CIQ:CREate</code>	720
<code>[:SOURce<hw>]:BB:ARbitrary:TSIGNal:RECTangle:CREate</code>	720
<code>[:SOURce<hw>]:BB:ARbitrary:TSIGNal:SINE:CREate</code>	720

`[:SOURce<hw>]:BB:ARbitrary:SIGNal:TYPE <ArbSignalType>`

Selects the type of test signal.

Parameters:

<ArbSignalType> SINE | RECT | CIQ
 *RST: SINE

Example: See [Example "Creating test signals"](#) on page 708.

Manual operation: See "Test Signal Form" on page 153

`[:SOURce<hw>]:BB:ARbitrary:TSIGNal:CIQ:I <I>`

`[:SOURce<hw>]:BB:ARbitrary:TSIGNal:CIQ:Q <TSig>`

Sets the value for the I and Q component of the test signal

Parameters:

<TSig> float
 Range: -1 to 1
 Increment: 0.001
 *RST: 0
 Default unit: FS

Example: See [Example "Creating test signals"](#) on page 708

Manual operation: See "I Value, Q Value" on page 158

`[:SOURce<hw>]:BB:ARbitrary:TSIGNal:RECTangle:AMPLitude <Amplitude>`

Sets the digital amplitude of the rectangular wave.

Parameters:

<Amplitude> float
 Range: 0 to 1
 Increment: 0.001
 *RST: 0.800
 Default unit: FS

Example: see [Example "Creating test signals"](#) on page 708

Manual operation: See ["Amplitude"](#) on page 156

[:SOURce<hw>]:BB:ARbitrary:TSIGnal:RECTangle:FREQUENCY <Frequency>

Sets the frequency of the test signal.

Parameters:

<Frequency> float
 Range: 100 to depends on the installed options
 Increment: 0.01
 *RST: 1000
 Default unit: Hz

Example: See [Example "Creating test signals"](#) on page 708.

Manual operation: See ["Frequency"](#) on page 156

[:SOURce<hw>]:BB:ARbitrary:TSIGnal:RECTangle:OFFSet <Offset>

Sets the DC component.

Parameters:

<Offset> float
 Range: -1 to 1
 Increment: 0.001
 *RST: 0
 Default unit: FS

Example: see [Example "Creating test signals"](#) on page 708

Manual operation: See ["Offset DC"](#) on page 157

[:SOURce<hw>]:BB:ARbitrary:TSIGnal:RECTangle:SAMPles <Samples>

Sets the number of sample values required for the rectangular signal per period.

Parameters:

<Samples> integer
 Range: 4 to 1000
 *RST: 100

Example: See [Example "Creating test signals"](#) on page 708

Manual operation: See ["Samples per Period"](#) on page 156

[:SOURce<hw>]:BB:ARbitrary:TSIGnal:SINE:FREQuency <Frequency>

Sets the frequency of the simple sinusoidal test signal.

Parameters:

<Frequency> float
 Range: 100 to depends on the installed options
 Increment: 0.01
 *RST: 1000
 Default unit: Hz

Example: See [Example "Creating test signals"](#) on page 708.

Manual operation: See ["Frequency"](#) on page 155

[:SOURce<hw>]:BB:ARbitrary:TSIGnal:SINE:PHASe <Phase>

Sets the phase offset of the sine wave on the Q channel relative to the sine wave on the I channel.

Parameters:

<Phase> float
 Range: -180 to 180
 Increment: 0.01
 *RST: 90
 Default unit: DEG

Example: see [Example "Creating test signals"](#) on page 708

Manual operation: See ["Phase Offset Q"](#) on page 155

[:SOURce<hw>]:BB:ARbitrary:TSIGnal:SINE:SAMPles <Samples>

Sets the sample rate for the sine signal in samples per period.

The resulting clock rate must not exceed the maximum ARB clock rate (see data sheet).

The maximum value is automatically restricted by reference to the set frequency and has to fulfill the rule $Frequency * Samples \leq ARB \text{ clock rate}$.

Parameters:

<Samples> integer
 Range: 4 to 1000
 *RST: 100

Example: see [Example "Creating test signals"](#) on page 708

Manual operation: See ["Samples per Period"](#) on page 155

```
[:SOURce<hw>]:BB:ARbitrary:TSIGnal:CIQ:CREate:NAMed <Filename>
[:SOURce<hw>]:BB:ARbitrary:TSIGnal:RECTangle:CREate:NAMed <Filename>
[:SOURce<hw>]:BB:ARbitrary:TSIGnal:SINE:CREate:NAMed <Filename>
```

Generates a signal and saves it to a waveform file.

Setting parameters:

<Filename> string

Example: See [Example "Creating test signals"](#) on page 708

Usage: Setting only

Manual operation: See ["Generate Signal File"](#) on page 155

```
[:SOURce<hw>]:BB:ARbitrary:TSIGnal:CIQ:CREate
[:SOURce<hw>]:BB:ARbitrary:TSIGnal:RECTangle:CREate
[:SOURce<hw>]:BB:ARbitrary:TSIGnal:SINE:CREate
```

Generates a signal and uses it as output straight away.

Example: see [Example "Creating test signals"](#) on page 708

Usage: Event

Manual operation: See ["Generate Signal RAM"](#) on page 155

Waveform Commands



The following rule applies for all commands described in this section.

By default, the waveform files are saved in the default directory of the instrument, that is the `/var/user/` directory or the directory specified with the command `:MMEMory:CDIRectory`. To access the waveform files in this default directory, only the file name is required, without the path and the file extension (`*.wv`).

However, to access waveform files located in a directory different to the default one, the complete file path and file name are required.

```
[:SOURce<hw>]:BB:ARbitrary:WAVeform:CATalog?..... 720
[:SOURce<hw>]:BB:ARbitrary:WAVeform:CATalog:LENGth?..... 721
[:SOURce<hw>]:BB:ARbitrary:WAVeform:SELEct..... 721
[:SOURce<hw>]:BB:ARbitrary:WAVeform:DELEte..... 721
[:SOURce<hw>]:BB:ARbitrary:WAVeform:FREE?..... 721
[:SOURce<hw>]:BB:ARbitrary:WAVeform:POINts?..... 722
[:SOURce<hw>]:BB:ARbitrary:WAVeform:DATA..... 722
[:SOURce<hw>]:BB:ARbitrary:WAVeform:TAG?..... 723
[:SOURce<hw>]:BB:ARbitrary:CLOCK..... 723
[:SOURce<hw>]:BB:ARbitrary:WAVeform:CLOCK..... 724
```

```
[:SOURce<hw>]:BB:ARbitrary:WAVeform:CATalog?
```

Reads out the files extension `*.wv` in the default directory.

Return values:

<Catalog> string
Returns a list of the file names separated by commas

Example: see [Example "Managing waveform files"](#) on page 708

Usage: Query only

[:SOURce<hw>]:BB:ARbitrary:WAVEform:CATalog:LENGth?

Reads out the files with extension * .wv in the default directory and returns the number of waveform files in this directory. The default directory is set using command `MMEM:CDIRectory`.

Return values:

<Length> integer
Number of waveform files in default directory
Range: 0 to INT_MAX
*RST: 0

Example: see [Example "Managing waveform files"](#) on page 708

Usage: Query only

[:SOURce<hw>]:BB:ARbitrary:WAVEform:SElect <Filename>

Selects an existing waveform file, i.e. file with extension * .wv.

Parameters:

<Filename> string

Example: See [Example "Managing waveform files"](#) on page 708

Manual operation: See ["Load Waveform/File"](#) on page 152

[:SOURce<hw>]:BB:ARbitrary:WAVEform:DElete <Filename>

Deletes the specified waveform file. If the file is not on the default path, the path must be specified at the same time. The file extension may be omitted. Only files with the file extension * .wv are deleted.

Setting parameters:

<Filename> string

Example: See [Example "Managing waveform files"](#) on page 708

Usage: Setting only

[:SOURce<hw>]:BB:ARbitrary:WAVEform:FREE?

Queries the free disk space on the default path of the instrument's hard disk.

Return values:

<Free> integer
 Range: 0 to INT_MAX
 *RST: 1

Example: See [Example "Managing waveform files"](#) on page 708

Usage: Query only

[:SOURce<hw>]:BB:ARbitrary:WAVEform:POINTs?

Queries the number of samples (the number of I/Q values pairs) in the selected waveform file.

Return values:

<Points> <waveform filename>
 Range: 0 to 1000
 *RST: 1

Example: see [Example "Managing waveform files"](#) on page 708

Usage: Query only

[:SOURce<hw>]:BB:ARbitrary:WAVEform:DATA <Filename>, <Data>**[:SOURce<hw>]:BB:ARbitrary:WAVEform:DATA? <Tag>**

The **setting** command writes the binary block data <data> to the file identified by <filename>. The *complete content* of the waveform file (i.e. including all tags) must be specified; the complete content is transmitted as binary data block.

I/Q data and the marker data can also be written to a file with the command : [MMEMemory:DATA:UNPRotected](#).

Tip: To ensure trouble-free data transmission, set the GPIB delimiter to EOI.

The **query** command retrieves the content of the specified tag of the currently selected waveform file or the waveform file specified with the <filename>.

See also ["Tag Description"](#) on page 750.

Setting parameters:

<Data> block data

Binary block data with the following syntax:
 #<Digits><Length><Binary data>

#
 Indicates the start of the binary block

<Digits>
 Decimal value
 Gives the number of decimal digits used for the <Length> value

<Length>
 Decimal value
 Number of bytes the follow in the <Binary data> part

<Binary data>
 Binary data in ASCII format

Query parameters:

<Tag> 'comment' | 'copyright' | 'date' | 'lacfiter' | 'marker name' | 'poweroffset'

Parameters for setting and query:

<Filename> string

Specifies the name of the waveform file in that the binary data is copied

Example: Query
 See [Example "Managing waveform files"](#) on page 708

Example: Setting

```
SOURce:BB:ARB:WAVEform:DATA "/var/user/test1.wv",#220<binary data>
// Writes the binary block data <binary data> to file test1.wv
// <binary data> contains 20 bytes
// <binary data> is a placeholder;
// the actual ASCII values are not printable
```

[[:SOURce<hw>]:BB:ARbitrary:WAVEform:TAG?

Queries the content of the specified tag of the selected waveform file (see also [Chapter 12.16.4.4, "Waveform, Data and List Format"](#), on page 750).

Return values:

<Tag> 'comment' | 'copyright' | 'date' | 'lacfiter' | 'marker name' | 'poweroffset' | 'samples'

Example: see [Example "Managing waveform files"](#) on page 708

Usage: Query only

[[:SOURce<hw>]:BB:ARbitrary:CLOCK <Clock>

Sets the clock rate.

If you load a waveform, the clock rate is determined as defined with the waveform tag {**CLOCK: frequency**}. This command subsequently changes the clock rate; see data sheet for value range.

Parameters:

<Clock> float
 Range: depends on the installed options
 Increment: 0.001
 *RST: 1E6
 Default unit: Hz
 E.g. 400 Hz to 600 MHz

Example: See [Example "Managing waveform files"](#) on page 708.

Manual operation: See ["Clock Frequency"](#) on page 153

[:SOURce<hw>]:BB:ARbitrary:WAVEform:CLOCK <Filename>, <Clock>

Appends information on the ARB clock rate to specified waveform file. The file must contain I/Q and/or marker data and have been created with the command **:MMEMory:DATA:UNPRotected** on page 594.

Parameters:

<Filename> string
 Complete file path and file name with file extension (* .wv).
 If the file is in the default directory, the file path can be omitted.

Setting parameters:

<Clock> float
 Range: 400 to 100E6
 Increment: 1E-3
 *RST: 1E6

Example: see **:MMEMory:DATA:UNPRotected** on page 594

Multi-Segment Commands**Required options**

See [Chapter 3.7.1, "Required Options"](#), on page 167.

[:SOURce<hw>]:BB:ARbitrary:WSEGment?	725
[:SOURce<hw>]:BB:ARbitrary:WSEGment:NAME?	725
[:SOURce<hw>]:BB:ARbitrary:WSEGment:NEXT	725
[:SOURce<hw>]:BB:ARbitrary:WSEGment:NEXT:EXECute	725
[:SOURce<hw>]:BB:ARbitrary:WSEGment:NEXT:SOURce	726
[:SOURce<hw>]:BB:ARbitrary:WSEGment:LMODe	726
[:SOURce<hw>]:BB:ARbitrary:WSEGment:CONFigure:SEGment:CATalog?	726
[:SOURce<hw>]:BB:ARbitrary:WSEGment:SEQuence:SElect	726
[:SOURce<hw>]:BB:ARbitrary:WSEGment:SEQuence:APPend	727
[:SOURce<hw>]:BB:ARbitrary:WSEGment:CREate	727

<code>[:SOURce<hw>]:BB:ARbitrary:WSEgment:CLOad.....</code>	728
<code>[:SOURce<hw>]:BB:ARbitrary:WSEgment:CONFigure:MARKer:MODE.....</code>	728
<code>[:SOURce<hw>]:BB:ARbitrary:WSEgment:CONFigure:MARKer:ESEgment.....</code>	728
<code>[:SOURce<hw>]:BB:ARbitrary:WSEgment:CONFigure:MARKer:FSEgment.....</code>	728
<code>[:SOURce<hw>]:BB:ARbitrary:TRIGger:SMODE.....</code>	728

`[:SOURce<hw>]:BB:ARbitrary:WSEgment?`

Queries the index of the currently processed segment.

Return values:

<WSegment> integer
 Range: 0 to 1023
 *RST: 0

Example: see [Example "Configuring the output order of the segments"](#)
 on page 712

Usage: Query only

Manual operation: See ["Current Segment/Current Segment Index"](#) on page 186

`[:SOURce<hw>]:BB:ARbitrary:WSEgment:NAME?`

Queries the name of the waveform of the currently output segment of the multi-segment waveform.

Return values:

<Name> string

Example: See [Example "Configuring the output order of the segments"](#)
 on page 712

Usage: Query only

Manual operation: See ["Current Segment/Current Segment Index"](#) on page 186

`[:SOURce<hw>]:BB:ARbitrary:WSEgment:NEXT <Next>`

Selects the segment to be output.

Parameters:

<Next> integer
 Range: 0 to 1023
 *RST: 0

Example: see [Example "Configuring the output order of the segments"](#)
 on page 712

Manual operation: See ["Segment"](#) on page 187

`[:SOURce<hw>]:BB:ARbitrary:WSEgment:NEXT:EXECute`

Triggers manually switchover to the subsequent segment in the multi-segment file.

This command is disabled, if a sequencing play list is enabled.

Example: See [Example "Configuring the output order of the segments"](#) on page 712

Usage: Event

Manual operation: See ["Execute Next Segment"](#) on page 188

[:SOURce<hw>]:BB:ARbitrary:WSEgment:NEXT:SOURce <Source>

Selects the next segment source.

Parameters:

<Source> INTernal | NSEGM1
*RST: INTernal

Example: See [Example "Configuring the output order of the segments"](#) on page 712.

Manual operation: See ["Next Segment Source"](#) on page 188

[:SOURce<hw>]:BB:ARbitrary:WSEgment:LMODe <LevelMode>

Sets how the segments are leveled.

Parameters:

<LevelMode> HIGHest | UNCHanged
*RST: HIGHest

Example: :SOURce1:BB:ARbitrary:WSEgment:LMODe HIGHest

Manual operation: See ["Level Mode"](#) on page 188

[:SOURce<hw>]:BB:ARbitrary:WSEgment:CONFigure:SEgment:CATalog?

Queries the segments of the currently selected configuration file.

Return values:

<Catalog> string

Example: See [Example "Creating a multi-segment waveform"](#) on page 710.

Usage: Query only

Manual operation: See ["Multi Segment Table"](#) on page 177

[:SOURce<hw>]:BB:ARbitrary:WSEgment:SEQuence:SElect <Filename>

Selects the sequencing list (files with extension *.wvs)

Parameters:

<Filename> string

Example: see [Example "Using the ARB sequencer"](#) on page 713

Manual operation: See ["New/Load Sequencing List"](#) on page 183

[:SOURce<hw>]:BB:ARbitrary:WSEgment:SEquence:APPend <State>, <Segment>, <Count>, <Next>

Appends a new segment to the selected sequencing play list.

Setting parameters:

<State> ON | OFF
 Activates/deactivates the appended segment
 *RST: ON

<Segment> integer
 Indicates the number of the segment as in the multi-segment waveform file
 Range: 0 to SegmentCount - 1

<Count> integer
 Defines how many times this segment is repeated
 Range: 1 to 1048575

<Next> NEXT | BLANK | ENDLess | SEG0 | SEG1 | ... | SEG31 | 0...maxSegment
 Determines the action after completing the current segment, like for instance which segment is processed after the processing of the current one is finished.

Example: See [Example "Using the ARB sequencer"](#) on page 713

Usage: Setting only

Manual operation: See ["Append"](#) on page 185

[:SOURce<hw>]:BB:ARbitrary:WSEgment:CREate <FilenameInput>

Creates a multi-segment waveform (*.wv) using the current settings of the specified *configuration file* (*.inf_mswv).

Setting parameters:

<FilenameInput> Absolute file path, file name of the configuration file and file extension (*.inf_mswv)

Example: See [Example "Creating a multi-segment waveform"](#) on page 710

Usage: Setting only

Manual operation: See ["Save List/Save List As..."](#) on page 175

[:SOURce<hw>]:BB:ARBitrary:WSEgment:CLOad <FilenameInput>

Creates a multi-segment waveform using the current entries of the specified *configuration file* (* .inf_mswv).

The ARB generator is activated, the new multi-segment waveform (* .wv) is loaded and the first segment is output in accordance to the trigger settings.

Setting parameters:

<FilenameInput> string
 Absolute file path, file name of the configuration file and file extension (* .inf_mswv)

Example: See [Example "Creating a multi-segment waveform"](#) on page 710

Usage: Setting only

Manual operation: See ["Save List/Save List As..."](#) on page 175

[:SOURce<hw>]:BB:ARBitrary:WSEgment:CONFigure:MARKer:MODE <Mode>

Defines the way the marker information within the separate segments is processed.

Parameters:

<Mode> IGNore | TAKE
 *RST: TAKE

Example: see [Example "Adding extra marker signals"](#) on page 714

Manual operation: See ["Segment Marker"](#) on page 180

[:SOURce<hw>]:BB:ARBitrary:WSEgment:CONFigure:MARKer:ESEgment <Mode>

[:SOURce<hw>]:BB:ARBitrary:WSEgment:CONFigure:MARKer:FSEgment <Mode>

Enables/disables the generation of an additional marker restart signal at the beginning of the first segment (FSEgment) or at the beginning of each segment (ESEgment).

If additional marker generation is enabled, the existing marker signals in the individual segment waveform files are not considered.

Parameters:

<Mode> OFF | MRK1 | MRK2 | MRK3 | MRK4
 *RST: OFF

Example: see [Example "Adding extra marker signals"](#) on page 714

Manual operation: See ["Sequence Restart"](#) on page 180

[:SOURce<hw>]:BB:ARBitrary:TRIGger:SMODE <SMODE>

Selects the extended trigger mode for multi segment waveforms.

Parameters:

<SMODE> SAME | NEXT | SEQuencer | NSEam
 NSEam = Next Segment Seamless
 *RST: NEXT

Example: See [Example "Configuring the output order of the segments"](#) on page 712.

Manual operation: See ["Next Segment Mode"](#) on page 187

Multi-Segment Sequencing Commands**Required options**

See [Chapter 3.7.1, "Required Options"](#), on page 167.

[:SOURce<hw>]:BB:ARbitrary:WSEgment:CONFigure:BLANK:APPend	729
[:SOURce<hw>]:BB:ARbitrary:WSEgment:CONFigure:CATalog?	730
[:SOURce<hw>]:BB:ARbitrary:WSEgment:CONFigure:CLOCK	730
[:SOURce<hw>]:BB:ARbitrary:WSEgment:CONFigure:CLOCK:MODE	730
[:SOURce<hw>]:BB:ARbitrary:WSEgment:CONFigure:LEVel[:MODE]	730
[:SOURce<hw>]:BB:ARbitrary:WSEgment:CONFigure:COMMeNt	731
[:SOURce<hw>]:BB:ARbitrary:WSEgment:CONFigure:DELeTe	731
[:SOURce<hw>]:BB:ARbitrary:WSEgment:CONFigure:OFILe	731
[:SOURce<hw>]:BB:ARbitrary:WSEgment:CONFigure:SEGMeNt:APPend	731
[:SOURce<hw>]:BB:ARbitrary:WSEgment:CONFigure:SELeCt	732

[\[:SOURce<hw>\]:BB:ARbitrary:WSEgment:CONFigure:BLANK:APPend](#)
 <SampCount>, <Frequency>

Adds a blank segment to the multi-segment file.

Setting parameters:

<SampCount> float
 Specifies the number of samples.
 Range: 512 to 1E7
 Increment: 1
 *RST: 1000

<Frequency> float
 Determines the clock rate.
 Range: 400 Hz to depends on the installed options
 Increment: 0.001
 *RST: 1E8

Example: See [Example "Creating a multi-segment waveform"](#) on page 710

Usage: Setting only

Manual operation: See ["Blank Segment"](#) on page 178

[:SOURce<hw>]:BB:ARbitrary:WSEgment:CONFigure:CATalog?

Queries the available configuration files in the default directory. See also [Chapter 3.7.2.3, "File Concept"](#), on page 169.

Return values:

<Catalog> string

Example: see [Example "Creating a multi-segment waveform"](#) on page 710

Usage: Query only

Manual operation: See ["Load List"](#) on page 175

[:SOURce<hw>]:BB:ARbitrary:WSEgment:CONFigure:CLOCK <Clock>

Defines the clock rate used for multi-segment waveform output if the clock mode is USER.

Parameters:

<Clock> float
 Increment: 1E-3
 *RST: max SampleRate

Example: See [Example "Creating a multi-segment waveform"](#) on page 710

Manual operation: See ["User Clock Rate"](#) on page 180

[:SOURce<hw>]:BB:ARbitrary:WSEgment:CONFigure:CLOCK:MODE <Mode>

Selects the clock rate mode for the multi segment waveform. Use the command [\[:SOURce<hw>\]:BB:ARbitrary:WSEgment:CONFigure:CLOCK](#) to define the clock in clock mode user.

Parameters:

<Mode> UNCHanged | HIGHest | USER
 *RST: UNCHanged

Example: See [Example "Creating a multi-segment waveform"](#) on page 710.

Manual operation: See ["Clock"](#) on page 180

[:SOURce<hw>]:BB:ARbitrary:WSEgment:CONFigure:LEVel[:MODE] <Mode>

Selects the level mode, unchanged or equal RMS, for the multi-segment waveform.

Parameters:

<Mode> UNCHanged | ERMS
 *RST: UNCHanged

Example: See [Example "Creating a multi-segment waveform"](#) on page 710.

Manual operation: See ["Level"](#) on page 179

[:SOURce<hw>]:BB:ARbitrary:WSEgment:CONFigure:COMment <Comment>

Enters a comment for the selected configuration file.

Parameters:

<Comment> string

Example: See [Example "Creating a multi-segment waveform"](#) on page 710

Manual operation: See ["Comment"](#) on page 175

[:SOURce<hw>]:BB:ARbitrary:WSEgment:CONFigure:DELeTe <Filename>

Deletes the selected configuration file.

Setting parameters:

<Filename> string

Example: See [Example "Creating a multi-segment waveform"](#) on page 710.

Usage: Setting only

Manual operation: See ["Append/Delete/Shift Seg. Up/Down"](#) on page 178

[:SOURce<hw>]:BB:ARbitrary:WSEgment:CONFigure:OFILe <OFile>

Defines the file name of the output multi-segment waveform.

Parameters:

<OFile> string

Example: See [Example "Creating a multi-segment waveform"](#) on page 710

Manual operation: See ["Save List/Save List As..."](#) on page 175

**[:SOURce<hw>]:BB:ARbitrary:WSEgment:CONFigure:SEGment:APPend
<Waveform>**

Appends the specified waveform to the configuration file.

Setting parameters:

<Waveform> string

Example: see [Example "Creating a multi-segment waveform"](#) on page 710

Usage: Setting only

Manual operation: See ["Append/Delete/Shift Seg. Up/Down"](#) on page 178

[:SOURce<hw>]:BB:ARbitrary:WSEgment:CONFigure:SElect <Filename>

Selects a configuration file from the default directory. If a configuration file with the specified name does not yet exist, it is created. The file extension *.inf_mswv may be omitted.

Parameters:

<Filename> string

Example: see [Example "Creating a multi-segment waveform"](#) on page 710

Manual operation: See ["New List"](#) on page 175

Multi-Carrier Commands**Required options**

See [Chapter 3.8.1, "Required Options"](#), on page 198.

Suffixes

Suffix	Value range
CARRier<ch>	1 to 512

[:SOURce<hw>]:BB:ARbitrary:MCARrier:PRESet	733
[:SOURce<hw>]:BB:ARbitrary:MCARrier:SETTing:CATalog?	733
[:SOURce<hw>]:BB:ARbitrary:MCARrier:SETTing:LOAD	733
[:SOURce<hw>]:BB:ARbitrary:MCARrier:SETTing:STORE	734
[:SOURce<hw>]:BB:ARbitrary:MCARrier:CARRier:COUNT	734
[:SOURce<hw>]:BB:ARbitrary:MCARrier:CARRier:MODE	734
[:SOURce<hw>]:BB:ARbitrary:MCARrier:CARRier:SPACing	734
[:SOURce<hw>]:BB:ARbitrary:MCARrier:SAMPles?	735
[:SOURce<hw>]:BB:ARbitrary:MCARrier:TIME	735
[:SOURce<hw>]:BB:ARbitrary:MCARrier:CFACTOR:MODE	735
[:SOURce<hw>]:BB:ARbitrary:MCARrier:CLIPPing:CFACTOR	736
[:SOURce<hw>]:BB:ARbitrary:MCARrier:CLIPPing:CUTOFF	736
[:SOURce<hw>]:BB:ARbitrary:MCARrier:CLIPPing[STATE]	736
[:SOURce<hw>]:BB:ARbitrary:MCARrier:TIME:MODE	737
[:SOURce<hw>]:BB:ARbitrary:MCARrier:POWER:REFERENCE	737
[:SOURce<hw>]:BB:ARbitrary:MCARrier:OFFile	737
[:SOURce<hw>]:BB:ARbitrary:MCARrier:CLOAd	737
[:SOURce<hw>]:BB:ARbitrary:MCARrier:CLOCK?	738
[:SOURce<hw>]:BB:ARbitrary:MCARrier:CREate	738
[:SOURce<hw>]:BB:ARbitrary:MCARrier:CARRier<ch>:STATE	738
[:SOURce<hw>]:BB:ARbitrary:MCARrier:CARRier<ch>:FREQuency	739
[:SOURce<hw>]:BB:ARbitrary:MCARrier:CARRier<ch>:PHASe	739
[:SOURce<hw>]:BB:ARbitrary:MCARrier:CARRier<ch>:POWER	739
[:SOURce<hw>]:BB:ARbitrary:MCARrier:CARRier<ch>:DELay	740
[:SOURce<hw>]:BB:ARbitrary:MCARrier:CARRier<ch>:FILE	740
[:SOURce<hw>]:BB:ARbitrary:MCARrier:CARRier<ch>:CONFLict?	740

<code>[:SOURce<hw>]:BB:ARbitrary:MCARrier:EDIT:CARRier:STATe</code>	740
<code>[:SOURce<hw>]:BB:ARbitrary:MCARrier:EDIT:CARRier:START</code>	741
<code>[:SOURce<hw>]:BB:ARbitrary:MCARrier:EDIT:CARRier:STOP</code>	741
<code>[:SOURce<hw>]:BB:ARbitrary:MCARrier:EDIT:CARRier:POWer:STEP</code>	741
<code>[:SOURce<hw>]:BB:ARbitrary:MCARrier:EDIT:CARRier:POWer[:START]</code>	741
<code>[:SOURce<hw>]:BB:ARbitrary:MCARrier:EDIT:CARRier:PHASe:STEP</code>	742
<code>[:SOURce<hw>]:BB:ARbitrary:MCARrier:EDIT:CARRier:PHASe[:START]</code>	742
<code>[:SOURce<hw>]:BB:ARbitrary:MCARrier:EDIT:CARRier:DELay:STEP</code>	742
<code>[:SOURce<hw>]:BB:ARbitrary:MCARrier:EDIT:CARRier:DELay[:START]</code>	743
<code>[:SOURce<hw>]:BB:ARbitrary:MCARrier:EDIT:CARRier:FILE</code>	743
<code>[:SOURce<hw>]:BB:ARbitrary:MCARrier:EDIT:CARRier:EXECute</code>	743

`[:SOURce<hw>]:BB:ARbitrary:MCARrier:PRESet`

Sets all the multi-carrier parameters to their default values.

Example: `SOURce1:BB:ARbitrary:MCARrier:PRESet`

Usage: Event

Manual operation: See ["Set to Default"](#) on page 201

`[:SOURce<hw>]:BB:ARbitrary:MCARrier:SETTING:CATalog?`

Queries the available settings files in the specified default directory. Only files with the file extension `*.arb_multcarr` are listed.

Return values:

<Catalog> string

Example: See [Example "Generating a multi carrier signal"](#) on page 715

Usage: Query only

Manual operation: See ["Save/Recall Frame"](#) on page 202

`[:SOURce<hw>]:BB:ARbitrary:MCARrier:SETTING:LOAD <Filename>`

Loads the selected file from the default or the specified directory. Loaded are files with extension `*.arb_multcarr`.

Setting parameters:

<Filename> "<filename>"
 Filename or complete file path; file extension can be omitted

Example: See [Example "Generating a multi carrier signal"](#) on page 715.

Usage: Setting only

Manual operation: See ["Save/Recall Frame"](#) on page 202

[:SOURce<hw>]:BB:ARBitrary:MCARrier:SETTing:STORe <Filename>

Stores the current settings into the selected file; the file extension (*.arb_multcarr) is assigned automatically.

Setting parameters:

<Filename> string
 Filename or complete file path

Example: See [Example "Generating a multi carrier signal"](#) on page 715

Usage: Setting only

Manual operation: See ["Save/Recall Frame"](#) on page 202

[:SOURce<hw>]:BB:ARBitrary:MCARrier:CARRier:COUNT <Count>

Sets the number of carriers in the ARB multi-carrier waveform.

Parameters:

<Count> integer
 Range: 1 to 512
 *RST: 1

Example: See [Example "Generating a multi carrier signal"](#) on page 715

Manual operation: See ["Number of Carriers"](#) on page 202

[:SOURce<hw>]:BB:ARBitrary:MCARrier:CARRier:MODE <Mode>

The command sets the carrier frequency mode.

Parameters:

<Mode> EQUidistant | ARBitrary
 *RST: EQUidistant

Example: BB:ARB:MCAR:CARR:MODE EQU
 Sets an equidistant carrier spacing. The carrier frequency cannot be set.

Manual operation: See ["Mode"](#) on page 202

[:SOURce<hw>]:BB:ARBitrary:MCARrier:CARRier:SPACing <Spacing>

Sets the frequency spacing between adjacent carriers of the multi-carrier waveform (see [Chapter 3.8.2.1, "Defining the Carrier Frequency"](#), on page 199).

Parameters:

<Spacing> float
 Range: 0.0 to depends on the installed options, e.g. 120E6
 Increment: 0.01
 *RST: 0
 Default unit: Hz

Example: See [Example "Generating a multi carrier signal"](#) on page 715

Manual operation: See ["Carrier Spacing"](#) on page 202

[:SOURce<hw>]:BB:ARbitrary:MCARrier:SAMPles?

Queries the resulting file size.

Return values:

<Samples> integer
 Range: 0 to INT_MAX
 *RST: 0
 Default unit: samples

Example: SOURce1:BB:ARbitrary:MCARrier:SAMPles?
 Queries the file size of the currently calculated multi-carrier waveform.

Usage: Query only

Manual operation: See ["File Size"](#) on page 206

[:SOURce<hw>]:BB:ARbitrary:MCARrier:TIME <Time>

Sets the user-defined signal period.

Parameters:

<Time> float
 Range: 0 to 1E9
 Increment: 1E-9
 *RST: 0
 Default unit: s

Example: SOURce1:BB:ARbitrary:MCARrier:MODE USER
 Selects signal period mode user.
 SOURce1:BB:ARbitrary:MCARrier:TIME 10
 Sets a signal period of 10 seconds

Manual operation: See ["Signal Period"](#) on page 204

[:SOURce<hw>]:BB:ARbitrary:MCARrier:CFACTOR:MODE <Mode>

Sets the mode for optimizing the crest factor by calculating the carrier phases.

Parameters:

<Mode> OFF | MIN | MAX
 *RST: OFF

Example:

SOURce1:BB:ARbitrary:MCARrier:CFACTOR:MODE OFF
 Switches off automatic crest factor optimization.

Manual operation: See "[Crest Factor Mode](#)" on page 203

[:SOURce<hw>]:BB:ARbitrary:MCARrier:CLIPping:CFACTOR <CFactor>

Sets the value of the desired crest factor, if baseband clipping is enabled.

A target crest factor above the crest factor of the unclipped multicarrier signal has no effect.

Parameters:

<CFactor> float
 Range: -50 to 50
 Increment: 0.01
 *RST: 50
 Default unit: dB

Example:

See [\[:SOURce<hw>\]:BB:ARbitrary:MCARrier:CLIPping\[:STATe\]](#) on page 736.

Manual operation: See "[Target Crest Factor](#)" on page 203

[:SOURce<hw>]:BB:ARbitrary:MCARrier:CLIPping:CUTOFF <Cutoff>

Sets the cutoff frequency of the final low pass filter, if baseband clipping is enabled.

Parameters:

<Cutoff> float
 Range: 0 to 250E6
 Increment: 0.01
 *RST: 75E6

Example:

See [\[:SOURce<hw>\]:BB:ARbitrary:MCARrier:CLIPping\[:STATe\]](#) on page 736.

Manual operation: See "[Filter Cutoff Frequency](#)" on page 203

[:SOURce<hw>]:BB:ARbitrary:MCARrier:CLIPping[:STATe] <State>

Switches baseband clipping on and off.

Parameters:

<State> 0 | 1 | OFF | ON
 *RST: 0

Example:

```
SOURce1:BB:ARbitrary:MCARrier:CLIPPING:STATE ON
SOURce1:BB:ARbitrary:MCARrier:CLIPPING:CFACTOR 37
SOURce1:BB:ARbitrary:MCARrier:CLIPPING:CUTOFF 50
```

Manual operation: See ["Clipping"](#) on page 203

[:SOURce<hw>]:BB:ARbitrary:MCARrier:TIME:MODE <Mode>

Selects the mode for calculating the resulting signal period of the multi-carrier waveform. The resulting period is always calculated for all carriers in the carrier table irrespective of their state (ON/OFF).

Parameters:

<Mode> USER | LONG | SHORT | LCM
*RST: LONG

Example: BB:ARB:MCAR:TIME:MODE LONG
The resulting signal period is defined by the longest I/Q file in the carrier table. Shorter I/Q files are periodically repeated.

Manual operation: See ["Signal Period Mode"](#) on page 203

[:SOURce<hw>]:BB:ARbitrary:MCARrier:POWER:REFERENCE <Reference>

Defines the way the individual carriers in a composed multi carrier signal are leveled.

Parameters:

<Reference> RMS | PEAK
*RST: RMS

Manual operation: See ["Power Reference"](#) on page 204

[:SOURce<hw>]:BB:ARbitrary:MCARrier:OFILE <OFile>

Defines the output file name for the multi-carrier waveform (file extension * .wv).

This file name is required to calculate the waveform with the commands [:SOURce<hw>]:BB:ARbitrary:MCARrier:CLOAD or [:SOURce<hw>]:BB:ARbitrary:MCARrier:CREATE.

Parameters:

<OFile> string

Example: See [Example "Generating a multi carrier signal"](#) on page 715

Manual operation: See ["Output File"](#) on page 206

[:SOURce<hw>]:BB:ARbitrary:MCARrier:CLOAD

Creates a multi-carrier waveform using the current entries of the carrier table and activates the ARB generator.

Use the command `[:SOURce<hw>] :BB:ARbitrary:MCARrier:OFILe` to define the multi-carrier waveform file name. The file extension is `*.wv`.

Example: See [Example "Generating a multi carrier signal"](#) on page 715

Usage: Event

Manual operation: See ["Create/Create and Load"](#) on page 206

`[:SOURce<hw>] :BB:ARbitrary:MCARrier:CLOCK?`

Queries the resulting sample rate at which the multi-carrier waveform is output by the arbitrary waveform generator. The output clock rate depends on the number of carriers, carrier spacing, and input sample rate of the leftmost or rightmost carriers.

Return values:

<Clock> float
 Range: 400 to Max
 Increment: 1E-3

Example: `BB:ARB:MCAR:CLOC?`
 Queries the ARB multi-carrier output clock rate.

Usage: Query only

Manual operation: See ["Clock Rate"](#) on page 206

`[:SOURce<hw>] :BB:ARbitrary:MCARrier:CREate`

Creates a multi-carrier waveform using the current settings of the carrier table.

Use the command `[:SOURce<hw>] :BB:ARbitrary:MCARrier:OFILe` to define the multi-carrier waveform file name. The file extension is `*.wv`.

Example: See [Example "Generating a multi carrier signal"](#) on page 715

Usage: Event

Manual operation: See ["Create/Create and Load"](#) on page 206

`[:SOURce<hw>] :BB:ARbitrary:MCARrier:CARRier<ch>:STATe <State>`

Enables/diasbled the selected carrier.

Parameters:

<State> 0 | 1 | OFF | ON
 *RST: 0

Example: See [Example "Generating a multi carrier signal"](#) on page 715

Manual operation: See ["State"](#) on page 208

[[:SOURce<hw>]:BB:ARbitrary:MCARrier:CARRier<ch>:FREQuency <Frequency>

Sets or indicates the carrier frequency, depending on the selected carrier frequency mode.

Parameters:

<Frequency> integer
 Range: depends on the installed options
 *RST: 0
 E.g. -60 MHz to +60 MHz (base unit)

Example: SOURce1:BB:ARbitrary:MCARrier:CARRier:MODE ARB
 SOURce1:BB:ARbitrary:MCARrier:CARRier1:
 FREQuency 5.0
 Sets 5.0 MHz carrier frequency.

Manual operation: See "[Carrier Freq \[MHz\]](#)" on page 208

[[:SOURce<hw>]:BB:ARbitrary:MCARrier:CARRier<ch>:PHASe <Phase>

Sets the start phase of the selected carrier.

Parameters:

<Phase> float
 Range: 0 to 359.99
 Increment: 0.01
 *RST: 0
 Default unit: DEG

Example: SOURce1:BB:ARbitrary:MCARrier:CARRier19:PHASe
 90
 Sets a start phase.

Manual operation: See "[Phase](#)" on page 208

[[:SOURce<hw>]:BB:ARbitrary:MCARrier:CARRier<ch>:POWER <Power>

Sets the gain of the selected carrier.

Parameters:

<Power> float
 Range: -80 to 0
 Increment: 0.01
 *RST: 0
 Default unit: dB

Example: SOURce1:BB:ARbitrary:MCARrier:CARRier15:POWER
 -50
 Sets the power of carrier 15 to -50 dB.

Manual operation: See "[Gain](#)" on page 208

[:SOURce<hw>]:BB:ARbitrary:MCARrier:CARRier<ch>:DELay <Delay>

Sets the start delay of the selected carrier.

Parameters:

<Delay> float
 Range: 0 to 1
 Increment: 1E-9
 *RST: 0
 Default unit: s

Example: BB:ARB:MCAR:CARR15:DEL 5us
 sets a start delay of 50 us for carrier 15.

Manual operation: See "Delay" on page 208

[:SOURce<hw>]:BB:ARbitrary:MCARrier:CARRier<ch>:FILE <File>

Selects the file with I/Q data to be modulated onto the selected carrier.

Parameters:

<File> <file name>

Example: See [Example "Generating a multi carrier signal"](#) on page 715

Manual operation: See "File" on page 208

[:SOURce<hw>]:BB:ARbitrary:MCARrier:CARRier<ch>:CONFLICT?

Queries carrier conflicts. A conflict arises when the carriers overlap.

Return values:

<Conflict> 0 | 1 | OFF | ON
 0
 No conflict
 *RST: 0

Example: BB:ARB:MCAR:CARR:CONF?

Usage: Query only

Manual operation: See "!!!" on page 209

[:SOURce<hw>]:BB:ARbitrary:MCARrier:EDIT:CARRier:STATe <State>

Switches all the carriers in the selected carrier range on or off.

Parameters:

<State> 0 | 1 | OFF | ON
 *RST: 1

Example: BB:ARB:MCAR:EDIT:CARR:STAT ON
 Sets all the carriers in the carrier range to ON.

Manual operation: See "[Carrier State](#)" on page 210

```
[:SOURce<hw>]:BB:ARbitrary:MCARrier:EDIT:CARRier:START <Start>
[:SOURce<hw>]:BB:ARbitrary:MCARrier:EDIT:CARRier:STOP <Stop>
```

Selects the last carrier in the carrier range to which the settings shall apply.

Parameters:

```
<Stop>                integer
                        Range:    0 to 511
                        *RST:    0
```

Example: `BB:ARB:MCAR:EDIT:CARR:STOP 4`
The carrier range stops at carrier 4.

Manual operation: See "[Carrier Start/Start](#)" on page 210

```
[:SOURce<hw>]:BB:ARbitrary:MCARrier:EDIT:CARRier:POWER:STEP <Step>
```

Sets the step width by which the starting power of the carriers in the defined carrier range is incremented.

Parameters:

```
<Step>                float
                        Range:    -80 to 80
                        Increment: 0.01
                        *RST:    0
                        Default unit: dB
```

Example: `BB:ARB:MCAR:EDIT:CARR:POW -80dB`
Sets a power of -80 dB for the carriers in the carrier range.
`BB:ARB:MCAR:EDIT:CARR:POW:STEP 1 dB`
The power is incremented by 1dB for each carrier.
That is, the first carrier has -80 dB, the second -79 dB, and so on.

Manual operation: See "[Gain Step](#)" on page 210

```
[:SOURce<hw>]:BB:ARbitrary:MCARrier:EDIT:CARRier:POWER[:START] <Start>
```

Sets the power for the individual carriers in the defined carrier range.

Parameters:

```
<Start>                float
                        Range:    -80 to 0
                        Increment: 0.01
                        *RST:    0
                        Default unit: dB
```

Example: `BB:ARB:MCAR:EDIT:CARR:POW -50 dB`
sets the power of the carriers in the carrier range to -50 dB.

Manual operation: See "Gain Start" on page 210

[[:SOURce<hw>]:BB:ARbitrary:MCARrier:EDIT:CARRier:PHASe:STEP <Step>

Sets the step width by which the start phases of the carriers in the defined carrier range is incremented.

Parameters:

<Step> float
 Range: -359.99 to 359.99
 Increment: 0.01
 *RST: 0
 Default unit: DEG

Example:

BB:ARB:MCAR:EDIT:CARR:PHAS 90 DEG

Sets a start phase of 90° for the carriers in the carrier range.

BB:ARB:MCAR:EDIT:CARR:PHAS:STEP 1 DEG

The start phase is incremented by 1° for each carrier. That is, the first carrier has a start phase of 90°, the second a start phase of 91°, and so on.

[[:SOURce<hw>]:BB:ARbitrary:MCARrier:EDIT:CARRier:PHASe[:START] <Start>

Sets the start phase for the individual carriers in the defined carrier range.

Parameters:

<Start> float
 Range: 0 to 359.99
 Increment: 0.01
 *RST: 0
 Default unit: DEG

Example:

BB:ARB:MCAR:EDIT:CARR:PHAS 90 DEG

sets a start phase of 90° for the carriers in the carrier range.

Manual operation: See "Phase Start" on page 210

[[:SOURce<hw>]:BB:ARbitrary:MCARrier:EDIT:CARRier:DELay:STEP <Step>

Sets the step width by which the start delays of the carriers in the defined carrier range is incremented.

Parameters:

<Step> float
 Range: -1 to 1
 Increment: 1E-9
 *RST: 0
 Default unit: s

Example: `BB:ARB:MCAR:EDIT:CARR:DEL 5 us`
 Sets a start delay of 5 us for the carriers in the carrier range.
`BB:ARB:MCAR:EDIT:CARR:DEL:STEP 1 us`
 The start delay is incremented by 1us for each carrier. That is, the first carrier has a start delay of 5 us, the second a start delay of 6 us, and so on.

Manual operation: See "[Delay Step](#)" on page 211

[:SOURce<hw>]:BB:ARbitrary:MCARrier:EDIT:CARRier:DELay[:START] <Start>

Sets the start delay for the individual carriers in the defined carrier range.

Parameters:

<Start> float
 Range: 0 to 1
 Increment: 1E-9
 *RST: 0
 Default unit: s

Example: `BB:ARB:MCAR:EDIT:CARR:DEL 5us`
 Sets a start delay of 5 us for the carriers in the carrier range.

Manual operation: See "[Delay Start](#)" on page 211

[:SOURce<hw>]:BB:ARbitrary:MCARrier:EDIT:CARRier:FILE <File>

Selects the input file. The data of the file are modulated onto the carriers in the defined carrier range.

Parameters:

<File> string

Example: `BB:ARB:MCAR:EDIT:CARR:FILE`
`"/var/user/temp/IQ_wcdma"`
 selects input file IQ_wcdma.

Manual operation: See "[Input Waveform File](#)" on page 211

[:SOURce<hw>]:BB:ARbitrary:MCARrier:EDIT:CARRier:EXECute

Adopts the settings for the selected carrier range.

Example: `BB:ARB:MCAR:EDIT:CARR:STAR 4`
`BB:ARB:MCAR:EDIT:CARR:STOP 20`
`BB:ARB:MCAR:EDIT:CARR:STAT ON`
`BB:ARB:MCAR:EDIT:CARR:EXEC`

Usage: Event

Manual operation: See "[Apply Assistant Settings](#)" on page 211

Trigger Commands

[:SOURce<hw>]:BB:ARBitrary[:TRIGger]:SEQUence.....	744
[:SOURce<hw>]:BB:ARBitrary:TRIGger:SOURce.....	744
[:SOURce<hw>]:BB:ARBitrary:TRIGger:RMODE?.....	745
[:SOURce<hw>]:BB:ARBitrary:TRIGger:SLENgth.....	745
[:SOURce<hw>]:BB:ARBitrary:TRIGger:SLUNit.....	745
[:SOURce<hw>]:BB:ARBitrary:TRIGger:ARM:EXECute.....	745
[:SOURce<hw>]:BB:ARBitrary:TRIGger:EXECute.....	746
[:SOURce<hw>]:BB:ARBitrary:TRIGger[:EXTErnal]:SYNChronize:OUTPut.....	746
[:SOURce<hw>]:BB:ARBitrary:TRIGger:DELay:UNIT.....	746
[:SOURce<hw>]:BB:ARBitrary:TRIGger[:EXTErnal]:DELay.....	746
[:SOURce<hw>]:BB:ARBitrary:TRIGger[:EXTErnal]:TDELay.....	747
[:SOURce<hw>]:BB:ARBitrary:TRIGger[:EXTErnal]:RDELay?.....	747
[:SOURce<hw>]:BB:ARBitrary:TRIGger[:EXTErnal]:INHibit.....	747

[:SOURce<hw>]:BB:ARBitrary[:TRIGger]:SEQUence <Sequence>

The command selects the trigger mode.

Parameters:

<Sequence> AUTO | RETRigger | AAUto | ARETrigger | SINGLE
*RST: AUTO

Example: See [Example "Managing waveform files"](#) on page 708

Manual operation: See ["Mode"](#) on page 110

[:SOURce<hw>]:BB:ARBitrary:TRIGger:SOURce <Source>

Selects the trigger signal source and determines the way the triggering is executed. Provided are:

- Internal triggering by a command (INTernal)
- External trigger signal via one of the User x connectors
 - EGT1: External global trigger
 - EGC1: External global clock
- In master-slave mode, the external baseband synchronization signal (BBSY)
- EXTernal: Setting only
Provided only for backward compatibility with other Rohde & Schwarz signal generators.
The R&S SMBV100B accepts this value and maps it automatically as follows:
EXTernal = EGT1

Parameters:

<Source> INTernal|EGT1|EGC1|EXTernal|BBSY
*RST: INTernal

Example: See [Example "Managing waveform files"](#) on page 708

Manual operation: See ["Source"](#) on page 111

[:SOURce<hw>]:BB:ARbitrary:TRIGger:RMODe?

Queries the status of waveform output.

Return values:

<RMode> STOP | RUN

Example: see [Example "Managing waveform files"](#) on page 708

Usage: Query only

Manual operation: See ["Running/Stopped"](#) on page 111

[:SOURce<hw>]:BB:ARbitrary:TRIGger:SEnGth <SLength>

Defines the length of the signal sequence that is output in the SINGLE trigger mode.

Parameters:

<SLength> integer

Maximum value depends on the selected units [:

[SOURce<hw>\]:BB:ARbitrary:TRIGger:SLUNit](#) as follows:

SAMPlE: Max = $2^{32}-1$

SEQuence: Max = 1000

Range: 1 to dynamic

*RST: 1

Example: See [Example "Managing waveform files"](#) on page 708

[:SOURce<hw>]:BB:ARbitrary:TRIGger:SLUNit <SLUnit>

Defines the unit for the entry of the length of the signal sequence to be output in the Single trigger mode.

Parameters:

<SLUnit> SEQuence | SAMPlE

*RST: SEQuence

Example: See [Example "Managing waveform files"](#) on page 708

Manual operation: See ["Signal Duration"](#) on page 111

[:SOURce<hw>]:BB:ARbitrary:TRIGger:ARM:EXECute

Stops (arms) waveform output.

Example: See [Example "Managing waveform files"](#) on page 708

Usage: Event

Manual operation: See ["Arm"](#) on page 111

[[:SOURce<hw>]:BB:ARbitrary:TRIGger:EXECute

Executes an internal trigger event.

Example: See [Example "Managing waveform files"](#) on page 708

Usage: Event

Manual operation: See ["Execute Trigger"](#) on page 111

**[[:SOURce<hw>]:BB:ARbitrary:TRIGger[:EXternal]:SYNChronize:OUTPut
<Output>**

Enables signal output synchronous to the trigger event.

Parameters:

<Output> 0 | 1 | OFF | ON
*RST: 1

Example: See [Example "Managing waveform files"](#) on page 708

Manual operation: See ["Sync. Output to External Trigger/Sync. Output to Trigger"](#) on page 112

[[:SOURce<hw>]:BB:ARbitrary:TRIGger:DELay:UNIT <TrigDelUnit>

Sets the units the trigger delay is expressed in.

Parameters:

<TrigDelUnit> SAMPLE | TIME
*RST: SAMPLE

Example: See [Example "Specifying delay and inhibit values in time units"](#) on page 710

Manual operation: See ["\(External\) Delay Unit"](#) on page 112

[[:SOURce<hw>]:BB:ARbitrary:TRIGger[:EXternal]:DELay <Delay>

Specifies the trigger delay.

Parameters:

<Delay> float
Range: 0 to 2147483647
Increment: 0.01
*RST: 0

Example: see [Example "Managing waveform files"](#) on page 708

Manual operation: See ["\(Specified\) External Delay/\(Specified\) Trigger Delay"](#) on page 113

[[:SOURce<hw>]:BB:ARbitrary:TRIGger[:EXternal]:TDElay <ExtTimeDelay>

Specifies the trigger delay for external triggering. The value affects all external trigger signals.

Parameters:

<ExtTimeDelay> float
 Range: 0 to 2147483647/clock rate
 Increment: 1E-9
 *RST: 0
 Default unit: s

Example: See [Example "Specifying delay and inhibit values in time units"](#) on page 710

Manual operation: See ["\(Specified\) External Delay/\(Specified\) Trigger Delay"](#) on page 113

[[:SOURce<hw>]:BB:ARbitrary:TRIGger[:EXternal]:RDElay?

Queries the time (in seconds) an external trigger event is delayed for.

Return values:

<ResTimeDelaySec> float
 Range: 0 to 688
 Increment: 0.25E-9
 *RST: 0

Example: See [Example "Specifying delay and inhibit values in time units"](#) on page 710

Usage: Query only

Manual operation: See ["Actual Trigger Delay/Actual External Delay"](#) on page 113

[[:SOURce<hw>]:BB:ARbitrary:TRIGger[:EXternal]:INHibit <Inhibit>

Specifies the number of symbols by which a restart is inhibited.

Parameters:

<Inhibit> integer
 Range: 0 to 21.47*clockRate
 *RST: 0

Example: see [Example "Managing waveform files"](#) on page 708

Manual operation: See ["External / Trigger Inhibit"](#) on page 112

Marker Commands

[[:SOURce<hw>]:BB:ARbitrary:TRIGger:OUTPut<ch>:MODE..... 748
 [[:SOURce<hw>]:BB:ARbitrary:TRIGger:OUTPut<ch>:ONTime..... 748
 [[:SOURce<hw>]:BB:ARbitrary:TRIGger:OUTPut<ch>:OFFTime..... 748

<code>[:SOURce<hw>]:BB:ARbitrary:TRIGger:OUTPut<ch>:PATtern</code>	748
<code>[:SOURce<hw>]:BB:ARbitrary:TRIGger:OUTPut<ch>:PULSe:DIVider</code>	749
<code>[:SOURce<hw>]:BB:ARbitrary:TRIGger:OUTPut<ch>:PULSe:FREQUency?</code>	749
<code>[:SOURce<hw>]:BB:ARbitrary:TRIGger:OUTPut<ch>:DELay</code>	749

`[:SOURce<hw>]:BB:ARbitrary:TRIGger:OUTPut<ch>:MODE <Mode>`

Defines the signal for the selected marker output.

For detailed description of the regular marker modes, refer to ["Marker Modes"](#) on page 94.

Parameters:

<Mode> UNCHanged | REStart | PULSe | PATtern | RATio

UNCHanged

A marker signal as defined in the waveform file (tag 'marker mode x') is generated.

*RST: UNCHanged

Example: see [Example "Managing waveform files"](#) on page 708

Manual operation: See ["Marker Mode"](#) on page 158

`[:SOURce<hw>]:BB:ARbitrary:TRIGger:OUTPut<ch>:ONTime <OnTime>`

`[:SOURce<hw>]:BB:ARbitrary:TRIGger:OUTPut<ch>:OFFTime <OffTime>`

Sets the number of samples in the ON and OFF periods.

Parameters:

<OffTime> integer
 Range: 1 to 14913079
 *RST: 1

Example: see [Example "Managing waveform files"](#) on page 708

Manual operation: See ["Marker Mode"](#) on page 158

`[:SOURce<hw>]:BB:ARbitrary:TRIGger:OUTPut<ch>:PATtern <Pattern>, <BitCount>`

Defines the bit pattern used to generate the marker signal.

Parameters:

<Pattern> numeric
 *RST: #H2

<BitCount> integer
 0 = marker off, 1 = marker on
 Range: 1 to 64
 *RST: 2

Example: See [Example "Managing waveform files"](#) on page 708.

Manual operation: See ["Marker Mode"](#) on page 158

[:SOURce<hw>]:BB:ARbitrary:TRIGger:OUTPut<ch>:PULSe:DIVider <Divider>

Sets the divider for the pulsed marker signal.

Parameters:

<Divider> integer
 Range: 2 to 1024
 *RST: 2

Example: See [Example "Managing waveform files"](#) on page 708

Manual operation: See ["Marker Mode"](#) on page 158

[:SOURce<hw>]:BB:ARbitrary:TRIGger:OUTPut<ch>:PULSe:FREQUency?

Queries the pulse frequency of the pulsed marker signal. The pulse frequency is derived by dividing the symbol rate by the divider.

Return values:

<Frequency> float
 Increment: 0.001

Example: see [Example "Managing waveform files"](#) on page 708

Usage: Query only

Manual operation: See ["Marker Mode"](#) on page 158

[:SOURce<hw>]:BB:ARbitrary:TRIGger:OUTPut<ch>:DELay <Delay>

Defines the delay between the signal on the marker outputs and the start of the signals.

Parameters:

<Delay> float
 Range: 0 to depends on other values
 Increment: 0.001
 *RST: 0
 Default unit: Symbol

Example: see [Example "Managing waveform files"](#) on page 708

Manual operation: See ["Marker x Delay"](#) on page 114

Clock Commands

[:SOURce<hw>]:BB:ARbitrary:CLOCK:SOURce <Source>

Selects the clock source:

- INTernal: Internal clock reference

Parameters:

<Source> INTernal
 *RST: INTernal

Example: See [Example "Managing waveform files"](#) on page 708.

Manual operation: See ["Clock Source"](#) on page 115

12.16.4.4 Waveform, Data and List Format

The R&S SMBV100B uses a simple tag-oriented format for externally or internally generated waveforms, data and control lists. Files with this format can be transmitted via the GPIB interface from an external computer to the instrument and vice versa. These files are transmitted as a binary data block, using SCPI command [:SOURce<hw>]:BB:ARbitrary:WAVEform:DATA, [:SOURce<hw>]:BB:DM:DLIST:DATA, and [:SOURce<hw>]:BB:DM:CLIST:DATA.

Tag general format

Tags are self-contained information units, enclosed in braces {}. Their general format is {Name: Data} or {Name-Length: Data}. The colon separates the name part and the data part. The colon can be followed by a space for the sake of legibility.

- The **Name** identifies the tag. It is always expressed in capital letters.
- The **Data** is tag-specific, and usually it is in ASCII plain text.
- The **Length** specifies the number of bytes in a WAVEFORM tag, DATA LIST tag, or EMPTYTAG
 Length is an ASCII integer value, defining the number of bytes from the colon : to the end brace }

Rules

Each waveform file must begin with the TYPE tag. The sequence of the remaining tags is arbitrary. For each tag, an indication shows whether it must be included in the file concerned (mandatory) or may be included (optional).

Unknown tags are not analyzed by the R&S SMBV100B; they are left unchanged and saved without an error message for a possible further read back.

R&S SMU waveforms can also be loaded on the instrument, where they are converted internally into an R&S SMBV100B waveform.



In all examples of file contents listed in this section, the tags have been separated by line breaks for better reading.

Tag Description

This section describes the mandatory TYPE tag followed by description of all other tags in an alphabetical order. Most tags are valid for all three file types. If a tag is valid only for a single file type, e.g. only for a waveform, this fact is indicated in the description.

{TYPE: magic, xxxxxxxx}.....	751
{CLOCK: frequency}.....	752
{COMMENT: string}	752
{COPYRIGHT: string}.....	753
{DATA BITLENGTH: BitLength}.....	753
{DATA LIST-Length: #d0d1...dx...dN-1...}.....	753
{DATE: yyyy-mm-dd;hh:mm:ss}.....	754
{EMPTYTAG-Length: #EmptySequence}.....	754
{CONTROL LENGTH: ControlLength}.....	755
{LEVEL OFFS: RMSOffset_dB,PeakOffset_dB}.....	756
{SAMPLES: Samples}.....	757
{[TRACE] LIST [#]: Pos0:State0; Pos1:State1; ...PosN-1:StateN-1}.....	757
{WAVEFORM-Length: #I0Q0I1Q1...IxQx...IN-1QN-1...}.....	758
{MWV_SEGMENT_COUNT: NumOfSeg}.....	759
{MWV_SEGMENT_LENGTH: SamplesSeg0, SamplesSeg1, ..., SamplesSegN-1}.....	759
{MWV_SEGMENT_START: SampleStartOffsetSeg0, SampleStartOffsetSeg1, ..., SampleStartOffsetSegN-1}.....	759
{MWV_SEGMENT_CLOCK_MODE: Mode}.....	760
{MWV_SEGMENT_CLOCK: ClockSeg0, ClockSeg1, ..., ClockSegN-1}.....	760
{MWV_SEGMENT_LEVEL_OFFS: RMSOffs_dBSg0,PeakOffs_dBSg0, ..., RMSOffs_dBSgN-1, PeakOffs_dBSgN-1}.....	760
{MWV_SEGMENT_FILES: "FileNameSeg0.wv", "FileNameSeg1.wv", ..., "FileNameSegN-1.wv"}.....	761
{MWV_SEGMENTx_COMMENT: text}.....	761
{CONTROL LIST WIDTH4-Length: #m0m1...mx...mM-1}.....	761

{TYPE: magic, xxxxxxxx}

(mandatory, must be the first tag in the file)

Identifies the file as a valid R&S SMBV100B file. It must be present and must be the first in the waveform. If a file of the same name exists on the target medium, it is overwritten.

Setting parameters:

magic Designates the file type and has the following values:

SMU-WV

A valid R&S SMBV100B waveform.

SMU-MWV

A valid R&S SMBV100B multi-segment waveform.

SMU-DL

A valid R&S SMBV100B data list.

SMU-CL

A valid R&S SMBV100B control list.

xxxxxxx

Is an ASCII-coded checksum of the data part of the `WAVEFORM` tag in the file. This value is always 0 for data lists and control lists.

The checksum for waveforms is used for detecting transmission errors. If the `TYPE` tag contains 0 or a non-numeric value for the checksum, it is ignored.

It is calculated in accordance with the algorithm given below, where 'start' is a pointer to the first byte after the '#' character in the `WAVEFORM` tag and 'length' is the number of bytes between 'start' and the closing curly bracket (excluding the latter; 'length' must be divisible by 4 without a remainder):

```
UINT32 checksum(void *start, UINT32 length)
{
    UINT32 i, result = 0xA50F74FF;
    for(i=0; i < length/4; i++)
        result = result ^ ((UINT32 *)start)[i];
    return(result);
}
```

Example:

```
{TYPE: SMU-WV,106656}
BB:ARB:WAV:TAG? 'TYPE'
```

Queries the content of the `TYPE` tag.

Response: 'SMU-WV,106656'

This is a valid waveform.

{CLOCK: frequency}

(mandatory for waveforms)

The tag specifies the clock frequency at which the waveform has to be output, in Hz (on multi-segment waveforms this tag contains the maximal clock of all segments).

A query of `ARB:CLOCK?` after loading the waveform returns the value set using the `CLOCK` tag. This value can later be altered with the command `ARB:CLOCK?`.

Example:

```
{CLOCK: 54000000}
BB:ARB:WAV:TAG? 'CLOCK'
```

Queries the content of the `CLOCK` tag.

Response: 54000000

The clock frequency is set to 54 MHz.

Usage: Setting only

{COMMENT: string}

The tag contains a plain text ASCII string of arbitrary length. The string is not analyzed in the R&S SMBV100B. It is used to describe the file. The string is allowed to contain all printable ASCII characters except the closing curly bracket.

Example: {COMMENT: File with data for 3GPP enhanced channels}
 BB:ARB:WAV:TAG? 'COMMENT'
 Queries the content of the COMMENT tag of the selected waveform file.
 Response: 'File with data for 3GPP enhanced channels'
 The comment on the waveform reads "File with data for 3GPP enhanced channels".

Usage: Setting only

{COPYRIGHT: string}

The tag contains an ASCII string of arbitrary length. The string is not analyzed in the R&S SMBV100B. It is used to store copyright information about the file content.

Example: {COPYRIGHT: Rohde&Schwarz}
 BB:ARB:WAV:TAG? 'COPYRIGHT'
 Queries the content of the COPYRIGHT tag of the selected waveform file.
 Response: 'Rohde&Schwarz'
 Copyright resides with Rohde & Schwarz.

Usage: Setting only

{DATA BITLENGTH: BitLength}

(mandatory for data lists)

The tag defines the length of the data field in the DATA LIST tag in bits in ASCII format.

Example: {DATA BITLENGTH: 444}
 BB:DM:DLIS:SEL "/var/user/dl"
 BB:DM:DLIS:TAG? "dl", "DATA BITLENGTH"
 Queries the content of the DATA BITLENGTH tag of the selected data list file.
 Response: '444'
 The data list is 444 bits long.

Usage: Setting only

{DATA LIST-Length: #d0d1...dx...dN-1...}

(mandatory for data lists)

The tag contains the actual bit sequence of the data list in binary format.

Setting parameters:

Length	Defines the number of bytes in the <code>DATA LIST</code> tag in ASCII Format (see <code>{WAVEFORM-Length: #I0Q0I1Q1...IxQx...IN-1QN-1...}</code> for details).
dx	Data bits in binary format (8-bit unsigned characters, MSB first).
Example:	<code>{DATA LIST-17: #d0d1...dx...d127}</code> 16 bytes containing 128 data bits, first bit is the MS bit of the first byte.
Usage:	Setting only

{DATE: yyyy-mm-dd;hh:mm:ss}**(optional)**

The tag contains the date and time at which the file was created. The year must be expressed as four digits. The instrument does not analyze this tag.

Example:	<code>{DATE: 2009-04-02;14:32:12}</code> <code>BB:ARB:WAV:TAG? 'DATE'</code> Queries the content of the <code>DATE</code> tag of the selected waveform file. Response: <code>'2009-04-02;14:32:12'</code> The waveform was created on April 2, 2009 at 14 hrs 32 min
-----------------	--

Usage:	Setting only
---------------	--------------

{EMPTYTAG-Length: #EmptySequence}**(mandatory in automatically generated one and multi-segment waveforms)**

This tag is empty, i.e. contains no data, and is used as placeholder.

Setting parameters:

Length	An ASCII integer value that specifies the number of bytes in the <code>EMPTYTAG</code> , i.e. defines the number of bytes from the colon <code>:</code> to the end brace <code>}</code> Note: If you change the content of a waveform file, change also the <code>{EMPTYTAG-Length}</code> value. For example, if you add a tag or add bytes to a tag, reduce the length by the number of newly introduced bytes.
EmptySequence	An empty sequence containing blanks only. The number of used blanks is calculated as the difference between the hex addresses of the <code>{WAVEFORM}</code> tag and the hash sign <code>#</code> in the <code>{EMPTYTAG}</code> . The <code>{WAVEFORM}</code> tag always starts at hex address <code>#4000</code> .

Example:

```
{TYPE:SMU-WV, 837236424}
{COPYRIGHT:2003 Rohde&Schwarz SMU}
{DATE:2012-07-11;14:38:01}
{SAMPLES:80000}
{CLOCK:86666666.666666666}
{VECTOR MAX:1.000000038569158}
{LEVEL OFFS:3.333553817875577e-07,0}
{MARKER LIST 1:0:1;1:0;1249:0}
{MARKER LIST 2:0:1;1:0;1249:0}
{MARKER LIST 3:0:1;1:0;1249:0}
{MARKER LIST 4:0:1;1:0;1249:0}
{EMPTYTAG-15947:# ...}
{WAVEFORM-320017:#IQIQIQ...}
```

The example waveform file contains 436 (0x1b4) bytes before the # sign in the EMPTYTAG; the hex address of the # sign is 0x1b5. The {WAVEFORM} starts at 0x4000. The EMPTYTAG contains 15946 blanks and has a length of (15946+1) bytes.

Usage: Setting only

{CONTROL LENGTH: ControlLength}

(optional / recommended for marker and control lists)

The tag specifies the length of *all* control or marker list in ASCII format.

The control length influences the way the marker and control lists are processed, in particular the way traces are repeated; see [Figure 12-1](#).

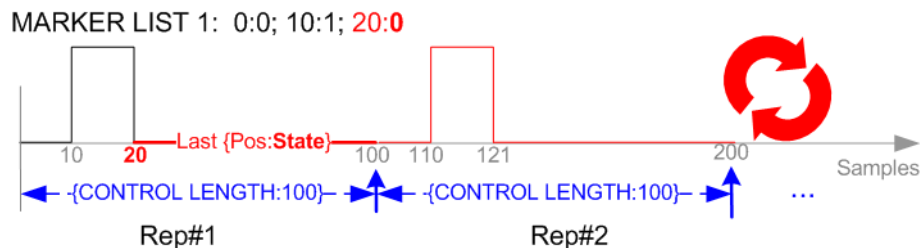

Figure 12-1: Example: Processing of MARKER TRACE if CONTROL LENGTH is specified

If the CONTROL LENGTH tag is not used, the marker and control list length are determined by the last position, that is the last {Pos:State} couple, defined in the particular [TRACE] LIST tag; see [Figure 12-2](#).

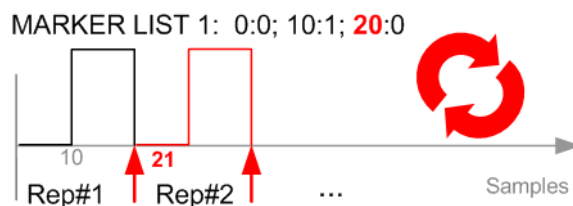

Figure 12-2: Example: Processing of MARKER TRACE if CONTROL LENGTH is not used

To maintain marker signals and waveform data synchronized, set the `CONTROL LENGTH` to be equal to the number of samples specified with the tag `SAMPLES`.

See also "[How to Define Periodically Repeating Traces](#)" on page 762.

Example: `{CONTROL LENGTH: 500}`
`SOURce:BB:ARBitary:CLISt:TAG? 'CONTROL LENGTH'`
 Queries the length of the control list.
 Response: 500

Manual operation: See "[Total List Length](#)" on page 132

{LEVEL OFFS: RMSOffset_dB,PeakOffset_dB}

(recommended for waveforms)

The tag determines the level of the ARB signal in the waveform file. The offset levels define the offset of RMS and peak value relative to the 16-bit full scale modulation (-32767 to + 32767) = 0 dB.

Setting parameters:

RMSOffset_dB Defines the RMS level offset of the signal relative to full scale ARB signal in the `WAVEFORM` tag. The offset is defined in ASCII float format. The value is always positive.
 A 3 dB value indicates that the RMS level of the signal is 3 dBs below the full scale.
 $\text{full scale} = \max. \text{amplitude of vector of I/Q samples} = |S_{IQ}|_{\max} = \sqrt{I^2+Q^2}_{\max} = 0 \text{ dB}$

PeakOffset_dB Defines the peak level offset of the signal relative to full scale for the ARB signal in the `WAVEFORM` tag. The offset is defined in ASCII float format.
 The value usually equals 0 dB as usually the I/Q samples (signed 16-bit integer values) are modulated to full scale: Full scale = 0 dB = $\max. \text{amplitude of vector of I/Q samples} = |S_{IQ}|_{\max} = \sqrt{I^2+Q^2}_{\max} = (2^{15})-1 = 32767$.
 A positive `PeakOffset_dB` value indicates that a headroom to full scale is provided when generating the waveform. A negative `PeakOffset_dB` value indicates that overrange is likely for some samples, i.e. clipping might occur.
 The crest factor can be calculated from the two values as follows:
 $\text{Crest Factor} = |\text{PeakOffset_dB} - \text{RMSOffset_dB}|$

Example: `{LEVEL OFFS: 3.45,2}`
`BB:ARB:WAV:TAG? 'LEVEL OFFS'`
 Queries the content of the `LEVEL OFFS` tag of the selected waveform file.
 Response: 3.45,2
 The level of the waveform is below full scale, clipping does not occur.

Usage: Setting only

{SAMPLES: Samples}**(recommended for waveforms)**

The tag contains the number of I/Q samples in the waveform in ASCII format.

On multi-segment waveforms, this tag contains the total I/Q samples of all segments.

Example: {SAMPLES: 1000}
 BB:ARB:WAV:TAG? 'SAMPLES'
 Queries the content of the SAMPLES tag of the selected waveform file.
 Response: 1000
 The waveform contains 1000 I/Q samples.

Usage: Setting only

See also "[How to Define Periodically Repeating Traces](#)" on page 762.

{[TRACE] LIST [#]: Pos0:State0; Pos1:State1; ...PosN-1:StateN-1}**(mandatory for control lists / optional for waveforms)**

The tag contains the data for the marker and control signals in the control list or the marker signals of ARB waveforms.

Traces are processed different, depending on the selected [CONTROL LENGTH](#).

See also "[How to Define Periodically Repeating Traces](#)" on page 762.

Setting parameters:

[TRACE]	MARKER BURST LEVATT CW MODE HOP MAP Name of the marker or control signal. For ARB waveforms, it is only meaningful to define marker signals; in the ARB multi-segment waveforms these tags are ignored!
[#]	1 .. 3 Sets the marker or control trace number; supported is only LEVATT LIST 1.
Pos	Specifies in ASCII format the position (i.e. sample number or data value), with effect from which the binary State of the marker or of the control signal changes.
State	0 1 Specifies the binary state of the marker or of the control signal from Pos _x to Pos _{x+1} exclusive in ASCII format.

- Example:** `{MARKER LIST 1: 0:0;10:1;20:0;30:1}`
`BB:DM:CLIS:TAG? 'MARKER LIST 1'`
 Queries the content of the `MARKER LIST 1` tag of the selected control list file.
 Response: `'0:0;10:1;20:0;30:1'`
 The marker setting for samples 0 to 9 = 0 (low), for 10 to 19 = 1 (high) and for 20 to 29 = 0. From sample 30 onward the marker setting = 1.
- Example:** `{LEVATT LIST 1: 0:0;10:1;20:0;30:1}`
`BB:DM:CLIS:TAG? 'LEVATT LIST 1'`
 Queries the content of the `LEVATT LIST 1` tag of the selected control list file.
 Response: `'0:0;10:1;20:0;30:1'`
 Level attenuation applies to data values 10 to 19 (high) and from data value 30 onward.
- Usage:** Setting only
- Manual operation:** See "[Select Ramp to Edit](#)" on page 132

{WAVEFORM-Length: #I0Q0I1Q1...IxQx...IN-1QN-1...}

(mandatory for waveforms)

Setting parameters:

- Length** Specifies the number of bytes in a `WAVEFORM` tag and is calculated as follows:

$$\text{Length} = \text{Number of I/Q pairs} * 4 \text{ (2 bytes per I and 2 bytes per Q value)} + 1 \text{ byte (the length of the \#)}$$
- IxQx** `IxQx...` represents binary data (16-bit signed integer in 2's complement notation) containing the I and Q component alternately and starting with the I component. Each component consists of 2 bytes in Little endian format representation, i.e. least significant byte (LSB) first.
 The values of the 2 bytes in an I component and a Q component are in the range 0x0 to 0xFFFF (-32767 to +32767). This value is transferred to the D/A converter.
 This tag is also used to store multi-segment waveforms. The I/Q streams of the individual waveforms are directly concatenated to one collectively waveform I/Q stream.
 The number of segments and the start offset and length of the individual segments inside the total waveform I/Q stream is determined by the additional tags `MWV_SEGMENT_COUNT`, `MWV_SEGMENT_START`, and `MWV_SEGMENT_LENGTH`.
 Further `MWV_SEGMENT_...` tags are also available, for example for level and clock information.

- Example:** **One segment waveform**
 {WAVEFORM-401:#I₀,Q₀,I₁,Q₁,I₂,Q₂,...I₉₉,Q₉₉}
 100 I/Q pairs with 4 bytes each are transmitted - none multi-segment
- Example:** **Multi-segment waveform**
 {WAVEFORM-1201:
 #I_{0,Seg0},Q_{0,Seg0},I_{1,Seg0},Q_{1,Seg0},...I_{99,Seg0},Q_{99,Seg0},I_{0,Seg1},Q_{0,Seg1},I_{1,Seg1},
 Q_{1,Seg1},... I_{199,Seg1},Q_{199,Seg1}}
 2 segments: segment 0 with 100 I/Q pairs; segment 1 with 200 I/Q pairs. Each I/Q pair consists of 2*16 bit = 4 bytes
- Usage:** Setting only

{MWV_SEGMENT_COUNT: NumOfSeg}**(mandatory for multi-segment waveforms)**

The tag contains the number of segments in the multi-segment waveform in ASCII integer format.

- Example:** {MWV_SEGMENT_COUNT: 2}
 Multi-segment waveform with 2 segments

Usage: Setting only

{MWV_SEGMENT_LENGTH: SamplesSeg0, SamplesSeg1, ..., SamplesSegN-1}**(mandatory for multi-segment waveforms)**

The tag contains a list of I/Q sample lengths for every segment in the multi-segment waveform in ASCII integer format.

- Example:** {MWV_SEGMENT_LENGTH: 100,200}
 2 segments: 100 samples in segment 0 and 200 samples in segment 1.

Usage: Setting only

{MWV_SEGMENT_START:

SampleStartOffsetSeg0, SampleStartOffsetSeg1, ..., SampleStartOffsetSegN-1}

(mandatory for multi-segment waveforms)

The tag contains a list of I/Q sample start offsets for every segment in the multi-segment waveform in ASCII integer format.

- Example:** {MWV_SEGMENT_START: 0,100}
 2 segments with 100 samples in segment 0 and 200 samples in segment 1.
 The start offset of first segment is 0 samples, start offset of next segment 1 is the sample length of segment 0 = 100 samples.

Usage: Setting only

{MWV_SEGMENT_CLOCK_MODE: Mode}

(mandatory for multi-segment waveforms)

The tag contains a string in ASCII format which supplies the clock rate mode, that was used for calculation of the multi-segment output waveform (see also "Clock" on page 180).

The tag `CLOCK` contains always the highest clock rate of all segments. The tag `MWV_SEGMENT_CLOCK` contains the clock rates of the individual segments.

Setting parameters:

Mode **UNCHANGED**
The segments may have different clock rates; each segment is output with the clock rate defined in its waveform file.

HIGHEST
All segments are output at the highest available clock rate.

USER
All segments are output at the clock rate defined by the user.
Note: Only upsampling is allowed, no downsampling!

Example: {MWV_SEGMENT_CLOCK_MODE: UNCHANGED}

Usage: Setting only

{MWV_SEGMENT_CLOCK: ClockSeg0, ClockSeg1, ..., ClockSegN-1}

(mandatory for multi-segment waveforms)

The tag contains a list of clock frequencies for every segment in the multi-segment waveform in ASCII floating point format.

Example: {MWV_SEGMENT_CLOCK: 100e6, 80e6}
2 segments: clock of segment 0 is 100 MHz, clock of segment 1 is 80 MHz.
Note: If the segments have different clock frequencies, there are some restrictions on signal output, i.e. seamless switching between segments is only possible, if all segments have the same clock frequency. Software resampling (upsampling) can be used to bring all segments to the same clock.

Usage: Setting only

{MWV_SEGMENT_LEVEL_OFFS:

RMSOffs_dBSg0, PeakOffs_dBSg0, ..., RMSOffs_dBSgN-1, PeakOffs_dBSgN-1}

(mandatory for multi-segment waveforms)

The tag contains a list of level pairs in ASCII floating point format, one pair for every segment in the multi-segment waveform. The first value of a level pair defines the rms offset and the second value the peak offset relative to the 16-bit full scale modulation (-32767; + 32767) = 0 dB. The meaning of one level value pair is the same as in the `LEVEL OFFS` tag for normal waveforms.

Example: {MWV_SEGMENT_LEVEL_OFFS: 3.0,0.0,6.0,0.0}
 2 segments: RMS level of segment 0 is 3 dB below full scale;
 RMS level of segment 1 is 6dB below full scale.
 Peak level of both segments is 0 dB full scale.

Usage: Setting only

{MWV_SEGMENT_FILES:
 "FileNameSeg0.wv", "FileNameSeg1.wv", ..., "FileNameSegN-1.wv"}
(optional for multi-segment waveforms)

The tag contains a list of file names for every segment in the multi-segment waveform in ASCII format.

Example: {MWV_SEGMENT_FILES: "d:\waveforms\sine.wv", "d:\waveforms\rect.wv"}

Usage: Setting only

{MWV_SEGMENTx_COMMENT: text}

(optional for multi-segment waveforms)

The tag contains a user comment for a specific segment $x = [0 \dots \text{NumOfSeg}-1]$ in the multi-segment waveform in ASCII format.

Example: {MWV_SEGMENT1_FILES: segment 1 contains a QPSK signal.}

Usage: Setting only

{CONTROL LIST WIDTH4–Length: #m0m1...mx...mM-1}

(optional for waveforms and multi-segment waveforms)

The tag contains a binary marker element stream, which is output synchronously to the I/Q sample sequence. One marker element m_x consists of 4 bit, which are assigned to the 4 possible marker lines of the instrument (1 bit per marker line). One 4-bit marker element is required for every I/Q sample in the WAVEFORM tag. Hence, the number of marker elements m should be equal to the number of I/Q samples. The CONTROL LENGTH tag has to contain the number of all marker elements m .

MSB 7	Byte						LSB 1
Marker element m_x (synchronous to I/Q Sample x)				Marker element m_{x+1} (synchronous to I/Q Sample $x+1$)			
Marker 4	Marker 3	Marker 2	Marker 1	Marker 4	Marker 3	Marker 2	Marker 1

Figure 12-3: Marker element in 4-bit binary format bit order

For standard waveforms, the `MARKER LIST x` tags are a more compact way to define markers, but in principle this `CONTROL LIST WIDTH4` format can also be used instead of the `MARKER LIST x` tags.

For multi-segment waveforms, this `CONTROL LIST WIDTH4` format is required for marker definition. The binary marker streams of the individual segments are directly concatenated (without any gap) to one collectively marker stream.

Setting parameters:

Length Defines the number of bytes in the `CONTROL LIST WIDTH4` tag in ASCII Format and is calculated as follows:
 $Length = Size\ of\ "\#\ " (1\ byte) + Number\ of\ marker\ elements\ m_x * (4\ bit) / (8\ bits/byte)$
 The value is rounded up for byte alignment.

mx Marker element in 4-bit binary format.

Example: `{CONTROL LIST WIDTH4-51: #m0m1...mx...m99}`
 100 marker elements, each marker element with 4 bits

Usage: Setting only

How to Define Periodically Repeating Traces

If a marker trace is required that marks for example each frame start, it is sufficient to define the trace ones and repeat it over the length of a waveform. This is useful if you describe a long waveform and a periodical marker is required.

The following examples use marker traces; control lists are processed in the same way.

To define periodical marker trace

The waveform in the example on [Figure 12-4](#) consists of 3 frames, each frame is 100-samples long. The waveform is processed continuously ("Trigger Mode > Auto").

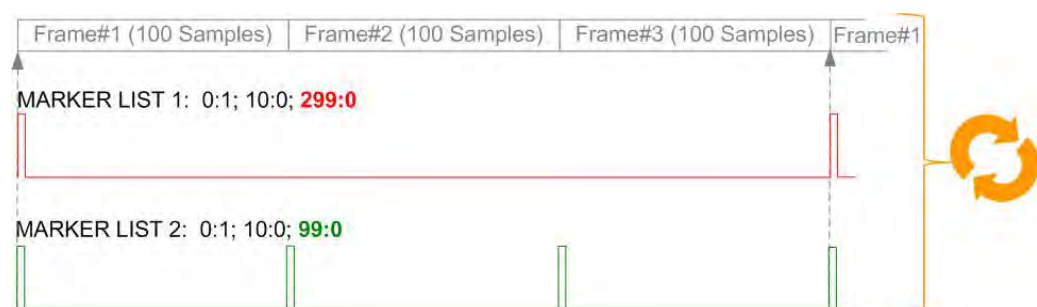

Figure 12-4: Example: Defining marker traces (`CONTROL LENGTH` tag is not used)

To define a restart marker and a frame start marker, use the following tags:

1. The waveform is 300 samples long, i.e. set `{SAMPLES: 300}`.
2. Set two `[TRACE] LIST` tags:
 - For Marker 1 that acts as a restart marker:

```
{MARKER LIST 1: 0:1; 10:0; 299:0}
```

- For Marker 2 that marks each frame start:

```
{MARKER LIST 2: 0:1; 10:0; 99:0}
```

3. Do not use the `CONTROL LENGTH` tag.

The length of the repeated patterns is determined by the last sample number in the `[TRACE] LIST`, that is the last `{Pos:State}`.

Example: How the `CONTROL LENGTH` tag influences the processing of the traces

For the example on [Figure 12-4](#), use the same marker traces and set the `CONTROL LENGTH` tag, e.g. `{CONTROL LENGTH: 150}`.

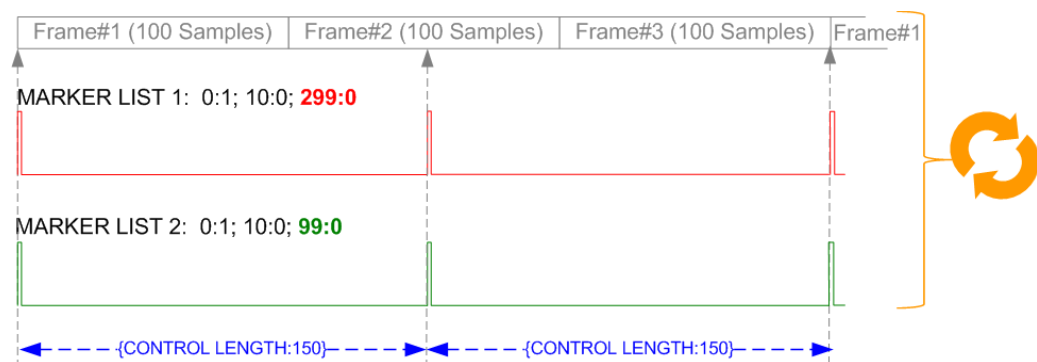

Figure 12-5: Example: Processing of control signals if the `CONTROL LENGTH` tag is used

The length of **all** control signals is determined by the `CONTROL LENGTH`. Observe how the marker traces are processed. In this example, both marker traces are repeated each 150 samples.

How to Manually Create a Waveform Using Tag File Format

The provided example uses a sine function in the I channel and a cosine function in the Q channel, each with 20 points. The example uses a short program written in the programming language C to calculate the sine and cosine values (see [Example "C-program for creating a waveform file"](#) on page 766). They are stored in the file `SICO.txt`. The decimal values in `SICO.txt` are normalized such that they are between -1.0 and $+1.0$. The data is converted into binary format. The appropriate mandatory tags are added and the data is packed into the `WAVEFORM` tag. As result, the waveform file `SICO.wv` is generated.

This example follows the general principle of creating of a waveform manually, using the tag file format. The [Figure 12-6](#) illustrates this general workflow.

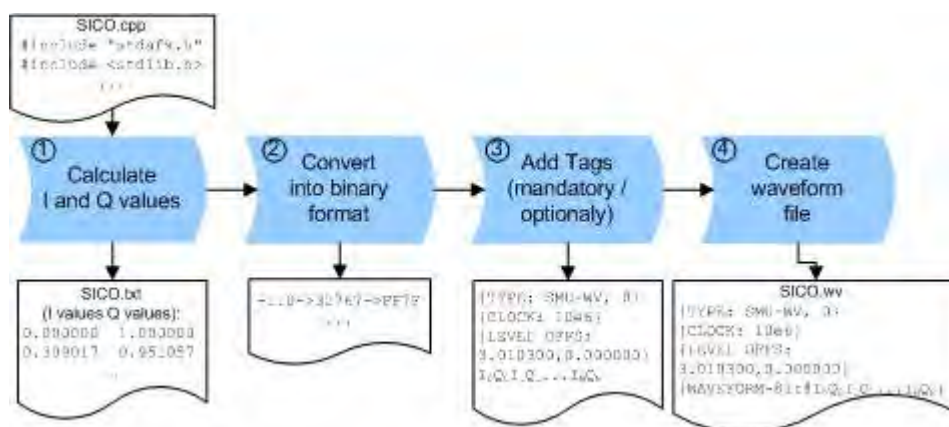

Figure 12-6: Principle of creating a waveform manually

The following steps outline how to create the waveform file `SICO.wv`:

1. Calculate the sine and cosine values, e.g. use the `SICO.cpp` program.

The result is stored in the file `SICO.txt`.

```

0.000000 1.000000
0.309017 0.951057
0.587785 0.809017
0.809017 0.587785
0.951057 0.309017
1.000000 -0.000000
0.951057 -0.309017
0.809017 -0.587785
0.587785 -0.809017
0.309017 -0.951057
-0.000000 -1.000000
-0.309017 -0.951056
-0.587785 -0.809017
-0.809017 -0.587785
-0.951056 -0.309017
-1.000000 0.000000
-0.951056 0.309017
-0.809017 0.587785
-0.587785 0.809017
-0.309017 0.951057

```

Figure 12-7: Contents of `SICO.txt`: first column Sine (I), second column Cosine (Q)

2. Convert the values from the file `SICO.txt` into binary format consisting of 16-bit signed integer numbers. The numeric range between -1.0 and $+1.0$ corresponds to the modulation range of the waveform 16-bit D/A converter of -32767 to $+32767$.

```

+1.0 -> 32767 -> = 0x7FFF
0.0 -> 0 -> = 0x0000
-1.0 -> -32767 -> = 0x8001

```

The [Figure 12-8](#) shows the calculation and conversion steps. The highlighted columns contain the resulting I and Q values represented in Little endian format.

Sample n	deg = 360°/20 * n	I = sin(deg)	I _{quant,dec} = I * FS = I * (2 ¹⁵ -1)	I _{quant,hex}	I _{quant,hex} (Little endian waveform file representation)	Q = cos(deg)	Q _{quant,dec} = I * FS = I * (2 ¹⁵ -1)	Q _{quant,hex}	Q _{quant,hex} (Little endian waveform file representation)
0	0	0.000000	0	0000	0000 I ₀	1.000000	32767	7FFF	FF7F Q ₀
1	18	0.309017	10126	278E	8E27	0.951057	31163	79BB	BB79
2	36	0.587785	19260	4B3C	3C4B	0.809017	26509	678D	8D67
3	54	0.809017	26509	678D	8D67	0.587785	19260	4B3C	3C4B
4	72	0.951057	31163	79BB	BB79	0.309017	10126	278E	8E27
5	90	1.000000	32767	7FFF	FF7F	0.000000	0	0000	0000
6	108	0.951057	31163	79BB	BB79	-0.309017	-10126	D872	72D8
7	126	0.809017	26509	678D	8D67	-0.587785	-19260	B4C4	C4B4
8	144	0.587785	19260	4B3C	3C4B	-0.809017	-26509	9873	7398
9	162	0.309017	10126	278E	8E27	-0.951057	-31163	8645	4586
10	180	0.000000	0	0000	0000	-1.000000	-32767	8001	0180
11	198	-0.309017	-10126	D872	72D8	-0.951057	-31163	8645	4586
12	216	-0.587785	-19260	B4C4	C4B4	-0.809017	-26509	9873	7398
13	234	-0.809017	-26509	9873	7398	-0.587785	-19260	B4C4	C4B4
14	252	-0.951057	-31163	8645	4586	-0.309017	-10126	D872	72D8
15	270	-1.000000	-32767	8001	0180	0.000000	0	0000	0000
16	288	-0.951057	-31163	8645	4586	0.309017	10126	278E	8E27
17	306	-0.809017	-26509	9873	7398	0.587785	19260	4B3C	3C4B
18	324	-0.587785	-19260	B4C4	C4B4	0.809017	26509	678D	8D67
19	342	-0.309017	-10126	D872	72D8	0.951057	31163	79BB	BB79

Figure 12-8: I and Q values calculation and conversion

- Use an ASCII editor which is able to handle binary data. Create and add the following mandatory tags before this binary data set can be further processed:

- CLOCK
- LEVEL OFFS

An example of the SICO.wv file contents could be:

```
{TYPE: SMU-WV, 0}{CLOCK: 10e6}{LEVEL OFFS: 3.010300,0.000000}
0000FF7F8E27BB79 ... 72D8BB79
```

To simplify the example, the checksum is set to 0, i.e. the instrument does not evaluate a checksum.

Tip: The tags TYPE, CLOCK, LEVEL OFFS and WAVEFORM are mandatory for each waveform. All other tags are optional and can be inserted after the TYPE tag in arbitrary order.

- Pack the binary data into a WAVEFORM tag with the described structure.

```
{WAVEFORM-Length: #I0Q0I1Q1I2Q2 ... InQn}
```

- Calculate the Length
Length = Number of I/Q pairs * 4 + 1 = 20*4 + 1 = 81 bytes
- Place the string {WAVEFORM-81: # at the beginning of the data set
- Place the symbol } at the end of the data set

The contents of the waveform file SICO.wv for 20 I/Q pairs is now ready for operation and reads:

```
{TYPE: SMU-WV, 0}
{CLOCK: 10e6}
{LEVEL OFFS: 3.010300,0.000000}
{WAVEFORM-81: #I0Q0I1Q1...InQn}
```

Note: There is no readable representation for binary values in this document. This is why we use the sequence I0Q0I1Q1...InQn to characterize the binary code in the present example.

The following figure shows this waveform in a data editor.

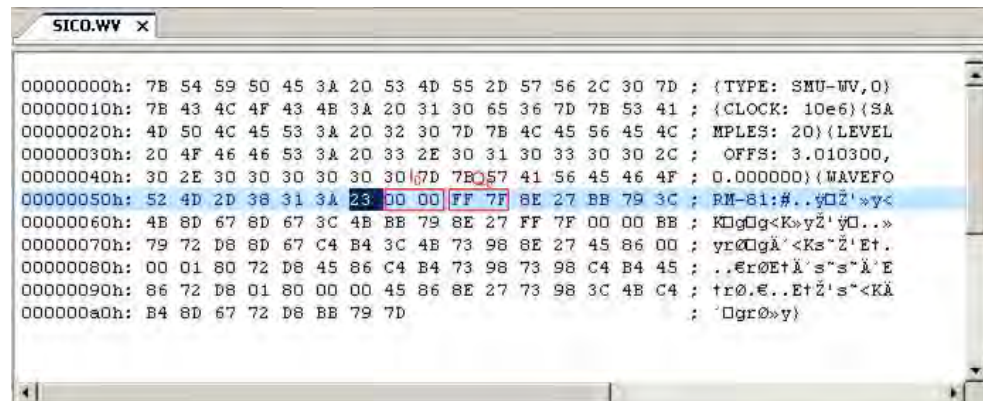

Example: C-program for creating a waveform file

C-program SICO.cpp for creating the file SICO.txt containing 20 sine and cosine pairs, converting them into binary data and creating the waveform file SICO.wv.

```
// SICO.cpp
// Defines the entry point for the console application

#include "stdafx.h"
#include <stdlib.h>
#include <stdio.h>
#include <math.h>

int _tmain(int argc, _TCHAR* argv[])
{
    const unsigned int samples = 20;
    const float pi = 3.141592654f;
    int i;

    // SICO.txt
    // Creating the file SICO.txt containing 20 sine and cosine pairs
    float grad, rad;
    FILE *fp;
    fp = fopen("SICO.txt", "w");
    if (fp == 0)
        return;
    for (i=0; i<samples; i++)
    {
        grad = (360.0f / (float)samples) * (float)i;
        rad = grad * (pi / 180.0f);
        fprintf(fp, "%f %f\n", sin(rad), cos(rad));
    }
    fclose(fp);
}
```

```

// SICO.wv
// Generating a binary data set from the I/Q pairs in the file SICO.txt
// and storing the result to file SICO.wv
FILE *fp_sour, *fp_dest;
float i_float, q_float;
unsigned short i_usint, q_usint;
fp_sour = fopen("SICO.TXT", "rt");
if (fp_sour == 0)
    return -1;
fp_dest = fopen("SICO.WV", "wb");
if (fp_dest == 0)
{
    fclose(fp_sour);
    return -1;
}
// Write required tags to waveform file
fprintf(fp_dest, "{TYPE: SMU-WV,0}");
fprintf(fp_dest, "{CLOCK: 10e6}");
fprintf(fp_dest, "{SAMPLES: %d}", samples);
// RMS, Peak
fprintf(fp_dest, "{LEVEL OFFS: %f,%f}", -1.0f * 20.0f * log10(1.0f/sqrt(2.0f)), 0.0f);
fprintf(fp_dest, "{WAVEFORM-%d:#", (samples * 4) + 1);
for (i=0; i<samples; i++)
{
    // Read I/Q pair from ASCII file
    if (fscanf(fp_sour, "%f %f", &i_float, &q_float) == EOF)
        break;
    // Convert I/Q pair to unsigned short
    i_usint = (unsigned short)floor((i_float * 32767.0) + 0.5);
    q_usint = (unsigned short)floor((q_float * 32767.0) + 0.5);
    // Write converted I/Q pair to waveform file
    fwrite(&i_usint, 2, 1, fp_dest);
    fwrite(&q_usint, 2, 1, fp_dest);
}
fprintf(fp_dest, "}");
fclose(fp_dest);
fclose(fp_sour);
return 0;
}

```

How to Create a Control List Using Tag File Format

The R&S SMBV100B provides the following ways to create a file containing control signals:

- to use the dedicated "Control Data Editor" and create a file in ASCII format and with extension *.dm_iqc, see ["To create a control list in ASCII format manually"](#) on page 134
- To use the tag-oriented format and create a control list file, see ["To create a control list using tag file format"](#) on page 768

- To use SCPI commands and create a file in binary format, see ["To create a control list in binary format"](#) on page 768

To create a control list using tag file format

To create an ASCII control list file directly, use the provided tag commands.

1. Use a hex data editor and create the **mandatory** tags:
 - `TYPE`
 - `[TRACE] LIST`

The `[TRACE] LIST` tag defines the individual markers or control traces in a combined `{Pos:State}` way within the control list period (`CONTROL LENGTH`).

2. Use a hex data editor and create the **recommended** tag `CONTROL LENGTH`.

This tag defines the *periodicity* of the total control list

3. Add the required optional tags.
They can be inserted after the `TYPE` tag in arbitrary order.

An example of the control list file contents could be:

```
{TYPE:SMU-CL}{COPYRIGHT:Rohde&Schwarz}
{DATE:2012-06-11;15:00:09}{HOP LIST:0:0;498:1;506:0}
{CW MODE LIST:0:0;380:1}{LEVATT LIST 3:0:0;464:1}
{BURST LIST:0:0;122:1;270:0;582:1;924:0}
{MARKER LIST 4:0:0;706:1;764:0}
{MARKER LIST 3:0:0;530:1;633:0}
{MARKER LIST 2:0:0;350:1;457:0}
{MARKER LIST 1:0:0;108:1;160:0}
{CONTROL LENGTH:1000}
```

The [Figure 3-10](#) shows the representation of the created control list in the "Control Data Editor".

Compare the displayed ramp values of "Marker 1" and the "Total List Length" with the values in the corresponding tags.

Note: In the provided example, the tags have been separated by line breaks for better reading.

See also [Example "How to assign and activate control signals from a control list"](#) on page 769.

To create a control list in binary format

Generation of a control list in binary format is not necessary but possible.

- Use the commands `BB:DM:CLIST:...` to generate a control list in binary format (see ["Handling List Files"](#) on page 701 and the example in `[:SOURce<hw>] :BB:DM:CLIST:DATA` on page 705).

See also [Example "How to assign and activate control signals from a control list"](#) on page 769.

Example: How to assign and activate control signals from a control list

Note: Irrespectively on the way they are created, generated control lists are not automatically used.

We assume, that a control list `clist.dm_iqc` containing information on marker 2, burst gate and level attenuation control signals is created and stored in the directory `/var/user/temp/`.

The following example shows how to enable the R&S SMBV100B to:

- Use the control list for a particular marker output, e.g. the "Custom Digital Modulation > Marker 2".
- Use the Burst Gate and Level Attenuation control signals as defined in a control list.

```
MMEM:CDIRectory "/var/user/temp"
SOURce1:BB:DM:CLISt:CATalog?
// Response: clist
SOURce1:BB:DM:CLISt:SElect "clist"
SOURce1:BB:DM:TRIGger:OUTPut2:MODE CLISt

SOURce1:BB:DM:PRAMp:SOURce INTernal
```

How to Create a Data List Using Tag File Format

The R&S SMBV100B provides the following ways to create a data list file:

- To use the dedicated "Data List Editor" and create a file with extension `*.dm_iqd`, see ["To create data lists manually"](#) on page 136.
- To use the tag-oriented format and create a data list file, see ["To create a data list file using tag file format"](#) on page 769.
- To use SCPI commands and create a file in binary format, see ["To create a data list in binary format"](#) on page 770.

To create a data list file using tag file format

- ▶ Use a hex data editor and create the mandatory tags: `{TYPE}`, `{DATA BITLENGTH}` and `{DATA LIST}`
Consider the tag syntax and rules.

The following is an example of the data list file content. The tags are separated by line breaks for better reading. The text in brackets is short explanation.

For details, see the tag description:

- `TYPE`
- `{DATA BITLENGTH}`
- `{DATA LIST-Length}`

```
{TYPE:SMU-DL} {COPYRIGHT:Rohde&Schwarz}
{DATE:201-06-11;15:00:09}
{DATA BITLENGTH: 8}
{DATA LIST-2: #d0d1...d7}
```

(1 byte containing 8 data bits d0 to d7 in binary format, where d0 is the MSB)

See also:

- [Figure 3-11](#) for representation of the created data list in the "Data List Editor".

- [Example "How to assign and activate a data list"](#) on page 770

To create a data list in binary format

- ▶ Use the commands `BB:DM:DLIST:...`, see ["Handling List Files"](#) on page 701.

```
MMEM:CDIRectory "/var/user"
// create a new data list file
SOURce1:BB:DM:DLIST:SElect "dl_new"
// append data to the data list and query the content
:FORMat ASCii
SOURce1:BB:DM:DLIST:DATA:APPend 0,1,1,1,0,1,0,1
SOURce1:BB:DM:DLIST:DATA?
// Response: 0,1,1,1,0,1,0,1
```

See also [Example "How to assign and activate a data list"](#) on page 770.

Example: How to assign and activate a data list

Note: Irrespectively on the way they are created, generated data lists are not automatically used.

We assume, that a data list `dl.dm_iqd` is created and stored in the directory `/var/user/`.

The following example shows how to enable the R&S SMBV100B to use this data list as data source for the custom digital modulation.

```
MMEM:CDIRectory "/var/user"
SOURce1:BB:DM:DLIST:CATalog?
// Response: dl
SOURce1:BB:DM:DLIST:SElect "dl"
```

Editing Waveform Files, Data and Control Lists

You can edit the internally and externally crated waveform files, data and control lists. The waveform, data and control lists files contain binary and ASCII data.

Consider the following rules while editing files with binary data.

Rules for editing binary data (waveforms, data and control lists)

- **Use hex data editor**
Always use a hex data editor to edit files containing binary data. Editing of binary data file with a text editor, even if you only change the ASCII part of the file, corrupts the file.
- **Adapt the length information in the {EMPTYTAG}**
If you change the content of a waveform file, change also the {EMPTYTAG-Length} value.
For example, if you add a tag or add bytes to an existing tag, reduce the length information by the number of newly introduced bytes.

12.16.4.5 SOURce:BB:MCCW Subsystem

This subsystem contains the commands for setting the Multi-Carrier CW signals.



The generation of multi-carrier CW signals requires an instrument equipped with the software options R&S SMBVB-K61.

Common Suffixes

The following common suffixes are used in remote commands:

Suffix	Value range	Description
SOURce<ch>	1	Available baseband signals
OUTPut<ch>	1 to 3	Available markers

Required options

See [Chapter 3.9.1, "Required Options"](#), on page 215

Programming Examples

Generating a multi-carrier signal to test the frequency response of a DUT

```
// *****
// Reset the instrument first
// *****
*RST; *CLS

// *****
// Configuring and enabling the multi-carrier signal
// *****
SOURce:BB:MCCW:CARRier:COUNT 81
SOURce:BB:MCCW:CARRier:SPACing 1E6
// Set the number of carriers and their distance
// Further settings stay in default state (for example trigger settings)

SOURce:BB:MCCW:STATe ON
// Enable signal generation

OUTPut ON
// Enable the signal output

// *****
// Storing the current settings
// *****
:MMEMory:MDIR '/var/user/savrcl'
// Create a new directory "savrcl"
*SAV 4
```

```
:MMEMory:STORe:STATe 4, "/var/user/savrcl/mccw_SSB.savrcltxt"
// Store the current settings in an intermediate memory with number 4
// Store the settings file in the specified directory; the complete path
// and filename has to be specified
```

To visualize the configured signal:

- Switch to local mode with the command `&NREN`
- Open the "Multi-carrier Continuous Wave > Carrier Graph"

Generating a multi-carrier signal to test the image rejection of an SSB filter

This example generates a multi-carrier single sideband signal as shown in [Figure 12-9](#).



Figure 12-9: Multi-carrier signal to test the image rejection of an SSB filter

```
// *****
// Reset the instrument first
// *****
*RST; *CLS

// *****
// Configuring and enabling the multi-carrier signal
// *****
SOURce:BB:MCCW:CARRier:COUNT 81
SOURce:BB:MCCW:CARRier:SPACing 1E6
// Set the number of carriers and their distance
// Further settings stay in default state (for example trigger settings)

SOURce:BB:MCCW:EDIT:CARRier:START 40
```

```

SOURce:BB:MCCW:EDIT:CARRier:STOP 80
SOURce:BB:MCCW:EDIT:CARRier:STATe OFF
SOURce:BB:MCCW:EDIT:CARRier:EXECute
// Configure the carrier table for the single sideband signal:
// Set the carriers no. 40 to 80 to "OFF"

SOURce:BB:MCCW:STATe ON
// Enable signal generation

OUTPut ON
// Enable signal output

```

Generating a composed multi-carrier signal

This example generates a multi-carrier signal as shown in [Figure 12-10](#).



Figure 12-10: Composed multi-carrier signal

```

// *****
// Reset the instrument first
// *****
*RST; *CLS

// *****
// Configuring the multi-carrier signal
// *****
SOURce:BB:MCCW:CARRier:COUNT 100
SOURce:BB:MCCW:CARRier:SPACing 500000
// Setup 100 carriers with a spacing of 500kHz

```

```

SOURce:BB:MCCW:CLOCK?
// Return value 128000000
SOURce:BB:MCCW:CFACTOR:MODE SLOW
SOURce:BB:MCCW:CFACTOR 3
SOURce:BB:MCCW:CFACTOR:ACTUAL?
// Return value 3

// *****
// Adjust the settings of a group of carriers
// *****
SOURce:BB:MCCW:CARRIER:LIST:POWER -6,-12,-18,-12,-6,0
// Set the power levels for carriers no. 0 to 5 to -10dB,-15dB,-20dB,-15dB,-10dB,0dB
SOURce:BB:MCCW:CARRIER:LIST:STATE ON,ON,ON,ON,ON,ON,OFF,ON
// Set the state of the carriers no. 0 to 7
SOURce:BB:MCCW:EDIT:CARRIER:START 15
SOURce:BB:MCCW:EDIT:CARRIER:STOP 35
SOURce:BB:MCCW:EDIT:CARRIER:STATE ON
SOURce:BB:MCCW:EDIT:CARRIER:POWER:STAR -10
SOURce:BB:MCCW:EDIT:CARRIER:POWER:STEP 0.5
SOURce:BB:MCCW:EDIT:CARRIER:EXECUTE
// Activates the carriers no. 15 to 35
// Increase the power in 0.5dB steps starting with a power level of -10dB
// Apply the settings

SOURce:BB:MCCW:CARRIER:POWER 38,0
SOURce:BB:MCCW:CARRIER:STATE 38,1
// Set a power level of 0dB for carrier no. 38 and activates it

SOURce:BB:MCCW:EDIT:CARRIER:START 41
SOURce:BB:MCCW:EDIT:CARRIER:STOP 61
SOURce:BB:MCCW:EDIT:CARRIER:STATE ON
SOURce:BB:MCCW:EDIT:CARRIER:POWER:START 0
SOURce:BB:MCCW:EDIT:CARRIER:POWER:STEP -0.5
SOURce:BB:MCCW:EDIT:CARRIER:EXECUTE
// Activates the carriers no. 41 to 61
// Decrease the power in 0.5dB steps starting with a power level of 0dB
// Apply the settings

SOURce:BB:MCCW:EDIT:CARRIER:START 70
SOURce:BB:MCCW:EDIT:CARRIER:STOP 85
SOURce:BB:MCCW:EDIT:CARRIER:STATE ON
SOURce:BB:MCCW:EDIT:CARRIER:EXECUTE
// Activates the carriers no. 70 to 85
// Apply the settings

// *****
// Configuring the clock settings
// *****
SOURce:BB:MCCW:CLOCK:SOURCE INTERNAL

```

```

// *****
// Configuring and enabling marker signals
// *****
SOURce:BB:MCCW:TRIGger:OUTPut1:MODE REStArt
SOURce:BB:MCCW:TRIGger:OUTPut2:MODE PULSe
SOURce:BB:MCCW:TRIGger:OUTPut2:PULSe:DIVider 5
SOURce:BB:MCCW:TRIGger:OUTPut2:PULSe:FREQuency?
SOURce:BB:MCCW:TRIGger:OUTPut3:MODE PATtern
SOURce:BB:MCCW:TRIGger:OUTPut3:PATtern #HE0F52,20
// SOURce:BB:MCCW:TRIGger:OUTPut1:MODE RATIo
// SOURce:BB:MCCW:TRIGger:OUTPut1:ONTime 40
// SOURce:BB:MCCW:TRIGger:OUTPut1:OFFTime 20
SOURce:BB:MCCW:TRIGger:OUTPut2:DELay 16

// *****
// Configuring and enabling signal triggering
// *****
SOURce:BB:MCCW:TRIGger:SEQuence SINGle
SOURce:BB:MCCW:TRIGger:SEnGth 200
// The first 200 samples of the current waveform will be output after
// the next trigger event
SOURce:BB:MCCW:TRIGger:SEQuence ARETrigger
SOURce:BB:MCCW:TRIGger:SOURce INTernal
// SOURce:BB:MCCW:TRIGger:SOURce EGT1
// An external global trigger signal must be provided at the connector
// configured for the External Global Trigger 1 signal
// SOURce:BB:MCCW:TRIGger:EXTernal:SYNChronize:OUTPut ON
// SOURce:BB:MCCW:TRIGger:EXTernal:DELay 200
// SOURce:BB:MCCW:TRIGger:EXTernal:INHibit 100

// *****
// Applying the settings and enabling signal generation
// *****
*TRG
SOURce:BB:MCCW:STATe ON
// Stop the internal trigger manually
SOURce:BB:MCCW:TRIGger:ARM:EXECute
// Execute manual internal trigger, i.e. restarting signal generation
SOURce:BB:MCCW:TRIGger:EXECute
SOURce:BB:MCCW:TRIGger:RMODe?
// RUN

```

General Settings and Carrier Setup Settings

[:SOURce<hw>]:BB:MCCW:PRESet.....	776
[:SOURce<hw>]:BB:MCCW:STATe.....	776
[:SOURce<hw>]:BB:MCCW:CARRier:COUnT.....	776
[:SOURce<hw>]:BB:MCCW:CARRier:SPACing.....	777
[:SOURce<hw>]:BB:MCCW:CLOCK?.....	777
[:SOURce<hw>]:BB:MCCW:CFACtor:MODE.....	777
[:SOURce<hw>]:BB:MCCW:CFACtor.....	777

[SOURce<hw>]:BB:MCCW:CFACtor:ACTual?	778
[SOURce<hw>]:BB:MCCW:CARRier:STATe	778
[SOURce<hw>]:BB:MCCW:CARRier:LIST:STATe	778
[SOURce<hw>]:BB:MCCW:CARRier:PHASe	779
[SOURce<hw>]:BB:MCCW:CARRier:LIST:PHASe	779
[SOURce<hw>]:BB:MCCW:CARRier:POWer	780
[SOURce<hw>]:BB:MCCW:CARRier:LIST:POWer	780
[SOURce<hw>]:BB:MCCW:EDIT:CARRier:PHASe[:START]	781
[SOURce<hw>]:BB:MCCW:EDIT:CARRier:POWer[:START]	781
[SOURce<hw>]:BB:MCCW:EDIT:CARRier:PHASe:STEP	781
[SOURce<hw>]:BB:MCCW:EDIT:CARRier:POWer:STEP	781
[SOURce<hw>]:BB:MCCW:EDIT:CARRier:START	782
[SOURce<hw>]:BB:MCCW:EDIT:CARRier:STOP	782
[SOURce<hw>]:BB:MCCW:EDIT:CARRier:STATe	782
[SOURce<hw>]:BB:MCCW:EDIT:CARRier:EXECute	782

[SOURce<hw>]:BB:MCCW:PRESet

Sets all multi carrier signal parameters to their default values.

Example: See "Programming Examples" on page 771

Usage: Event

Manual operation: See "Set to Default" on page 217

[SOURce<hw>]:BB:MCCW:STATe <State>

Enables/disables the multi carrier CW signal.

Parameters:

<State> 0 | 1 | OFF | ON
*RST: 0

Example: See "Programming Examples" on page 771

Manual operation: See "State" on page 216

[SOURce<hw>]:BB:MCCW:CARRier:COUNT <Count>

Sets the number of carriers in the multi carrier CW signal.

Parameters:

<Count> integer
Range: 1 to 160001
*RST: 64

Example: see "Programming Examples" on page 771

Manual operation: See "Number of Carriers" on page 217

[:SOURce<hw>]:BB:MCCW:CARRier:SPACing <Spacing>

Sets the carrier spacing.

Parameters:

<Spacing>	float
-----------	-------

Value range depends on the available bandwidth and the number of carriers, see "[Cross-reference between total bandwidth, carrier spacing, and number of carriers](#)" on page 217.

Range:	0 to depends on the installed options, e.g. 120E6
Increment:	0.01
*RST:	10E3

Example: See "[Programming Examples](#)" on page 771

Manual operation: See "[Carrier Spacing](#)" on page 217

[:SOURce<hw>]:BB:MCCW:CLOCK?

Queries the output clock rate. The output clock rate depends on the number of carriers and on the selected carrier spacing.

Return values:

<Clock>	float
---------	-------

Range:	0 to Max
Increment:	1E-3
*RST:	0

Example: See "[Programming Examples](#)" on page 771

Usage: Query only

Manual operation: See "[Clock Frequency](#)" on page 217

[:SOURce<hw>]:BB:MCCW:CFACTOR:MODE <Mode>

Sets the mode by which automatic settings minimize the crest factor or hold it at a chosen value.

Parameters:

<Mode>	OFF CHIRp SLOW
--------	--------------------

SLOW
corresponds to the manual control "Target Crest"

*RST:	CHIRp
-------	-------

Example: See "[Programming Examples](#)" on page 771

Manual operation: See "[Optimize Crest Factor Mode](#)" on page 217

[:SOURce<hw>]:BB:MCCW:CFACTOR <CFactor>

Sets the desired crest factor, if the optimization mode target crest factor is used.

Parameters:

<CFactor> float
 Range: 0 to 30
 Increment: 0.01
 *RST: 3

Example: See "Programming Examples" on page 771

Manual operation: See "Desired Crest Factor" on page 218

[:SOURce<hw>]:BB:MCCW:CFACTOR:ACTUAL?

Queries the actual Crest Factor for optimization mode target crest.

Return values:

<Actual> float
 Range: 0 to 100
 Increment: 0.01
 *RST: 3

Example: See "Programming Examples" on page 771

Usage: Query only

[:SOURce<hw>]:BB:MCCW:CARRIER:STATE <CarrierIndex>, <State>

Switches the selected carrier on or off.

Parameters:

<CarrierIndex> integer
 Range: 0 to lastCarrier
 <State> 0 | 1 | OFF | ON
 *RST: 0

Example: See "Programming Examples" on page 771

Manual operation: See "Carrier Table" on page 220

**[:SOURce<hw>]:BB:MCCW:CARRIER:LIST:STATE <Stat0[,Stat1..]>
[:SOURce<hw>]:BB:MCCW:CARRIER:LIST:STATE? <Start>, <Count>**

Switches the carrier on or off with the aid of a value list.

The first value in the list is assigned to the carrier with index 0, the second value to the carrier with index 1, etc. The maximum length corresponds to the maximum number of multi carriers. There is no need to enter all the values every time. Values not set by the value list are set with the default values provided they have already been explicitly set by a previous command. If this is the case, the values continue to apply until overwritten.

Setting parameters:

<Stat0[,Stat1..]> ON | OFF

Query parameters:

<Start>	integer start carrier index Range: 0 to lastCarrier
<Count>	integer number of carriers in the carrier range, starting from the <Start> carrier Range: 1 to lastCarrier

Return values:

<State[,State..]>	select
-------------------	--------

Example: See "Programming Examples" on page 771

Manual operation: See "Carrier Table" on page 220

[[:SOURce<hw>]:BB:MCCW:CARRier:PHASe <CarrierIndex>, <Phase>

For disabled optimization of the crest factor, sets the start phase of the selected carrier.

Parameters:

<CarrierIndex>	integer Range: 0 to lastCarrier
<Phase>	float Range: 0 to 359.99 Increment: 0.01 *RST: 0 Default unit: DEG

Example: see "Programming Examples" on page 771

Manual operation: See "Carrier Table" on page 220

[[:SOURce<hw>]:BB:MCCW:CARRier:LIST:PHASe <Phas0[,Phas1..]>

[[:SOURce<hw>]:BB:MCCW:CARRier:LIST:PHASe? [<Start>[, <Count>]]

Sets the start phase of the carrier with the aid of a value list.

Setting parameters:

<Phas0[,Phas1..]>	float Range: 0 to 360 Increment: 0.01 *RST: 0 Default unit: DEG
-------------------	---

Query parameters:

<Start>	integer start carrier index Range: 0 to lastCarrier
---------	---

<Count> integer
 number of carriers in the carrier range, starting from the
 <Start> carrier
 Range: 1 to max

Return values:

<Phas[,Phas..]> float

Example: see "Programming Examples" on page 771

Manual operation: See "Carrier Table" on page 220

[:SOURce<hw>]:BB:MCCW:CARRIER:POWER <CarrierIndex>, <Power>

Sets the power of the selected carrier.

Parameters:

<CarrierIndex> integer
 Range: 0 to lastCarrier

<Power> float
 Range: -80 to 0
 Increment: 0.01
 *RST: 0

Example: see "Programming Examples" on page 771

Manual operation: See "Carrier Table" on page 220

**[:SOURce<hw>]:BB:MCCW:CARRIER:LIST:POWER <Pow0[,Pow1..]>
 [:SOURce<hw>]:BB:MCCW:CARRIER:LIST:POWER? <Start>, <Count>**

Sets the power of the carrier with the aid of a value list.

Setting parameters:

<Pow0[,Pow1..]> float
 Increment: 0.01
 *RST: 0 dB

Query parameters:

<Start> integer
 start carrier index
 Range: 0 to lastCarrier

<Count> integer
 number of carriers in the carrier range, starting from the
 <Start> carrier
 Range: 1 to lastCarrier

Return values:

<Pow[,Pow..]> float

Example: see "Programming Examples" on page 771

Manual operation: See ["Carrier Table"](#) on page 220

```
[ :SOURce<hw>]:BB:MCCW:EDIT:CARRier:PHASe[:START] <Start>
[:SOURce<hw>]:BB:MCCW:EDIT:CARRier:POWER[:START] <Start>
```

Sets the power/pahse for the starting carrier. The power of the remaining carriers is stepped up or down by the power specified with the `[:SOURce<hw>]:BB:MCCW:EDIT:CARRier:POWER:STEP` command.

Parameters:

```
<Start>          float
                  Range:    -80 to 0
                  Increment: 0.01
                  *RST:     0
```

Example: see ["Programming Examples"](#) on page 771

Manual operation: See ["Power Start"](#) on page 219

```
[ :SOURce<hw>]:BB:MCCW:EDIT:CARRier:PHASe:STEP <Step>
```

For disabled optimization of the crest factor, sets the step width by which the start phase of the carriers in the defined carrier range is incremented.

Parameters:

```
<Step>          float
                  Range:    -359.99 to 359.99
                  Increment: 0.01
                  *RST:     0
```

Example: See ["Programming Examples"](#) on page 771

Manual operation: See ["Phase Step"](#) on page 220

```
[ :SOURce<hw>]:BB:MCCW:EDIT:CARRier:POWER:STEP <Step>
```

Sets the step width by which the starting power of the carriers in the defined carrier range is incremented.

Parameters:

```
<Step>          float
                  Range:    -80 to 80
                  Increment: 0.01
                  *RST:     0
```

Example: See ["Programming Examples"](#) on page 771

Manual operation: See ["Power Step"](#) on page 220

[[:SOURce<hw>]:BB:MCCW:EDIT:CARRier:START <Start>

[[:SOURce<hw>]:BB:MCCW:EDIT:CARRier:STOP <Stop>

Defines the first/last carrier in the carrier range to which joint configuration applies.

Parameters:

<Stop> integer
 Range: 0 to 8191
 *RST: 0

Example: See "Programming Examples" on page 771

Manual operation: See "Carrier Start/Stop" on page 219

[[:SOURce<hw>]:BB:MCCW:EDIT:CARRier:STATe <State>

Switches all the carriers in the selected carrier range on or off.

Parameters:

<State> 0 | 1 | OFF | ON
 *RST: 1

Example: See "Programming Examples" on page 771

Manual operation: See "Carrier State" on page 219

[[:SOURce<hw>]:BB:MCCW:EDIT:CARRier:EXECute

Adopts the settings for the carrier range.

Example: See "Programming Examples" on page 771

Usage: Event

Manual operation: See "Accept" on page 220

Trigger Settings

[[:SOURce<hw>]:BB:MCCW:TRIGger:ARM:EXECute.....	782
[[:SOURce<hw>]:BB:MCCW:TRIGger:EXECute.....	783
[[:SOURce<hw>]:BB:MCCW:TRIGger:EXTErnal:SYNChronize:OUTPut.....	783
[[:SOURce<hw>]:BB:MCCW:TRIGger:RMODE?.....	783
[[:SOURce<hw>]:BB:MCCW:TRIGger:SLENGth.....	783
[[:SOURce<hw>]:BB:MCCW:TRIGger:SOURce.....	784
[[:SOURce<hw>]:BB:MCCW:TRIGger[:EXTErnal]:DELay.....	784
[[:SOURce<hw>]:BB:MCCW:TRIGger[:EXTErnal]:INHibit.....	784
[[:SOURce<hw>]:BB:MCCW[:TRIGger]:SEQUence.....	785

[[:SOURce<hw>]:BB:MCCW:TRIGger:ARM:EXECute

Stops signal generation.

Example: See "Programming Examples" on page 771

Usage: Event
Manual operation: See ["Arm"](#) on page 111

[:SOURce<hw>]:BB:MCCW:TRIGger:EXECute

Executes a trigger.

Example: See ["Programming Examples"](#) on page 771

Usage: Event

Manual operation: See ["Execute Trigger"](#) on page 111

[:SOURce<hw>]:BB:MCCW:TRIGger:EXTernal:SYNChronize:OUTPut <Output>

Enables signal output synchronous to the trigger event.

Parameters:

<Output> 0 | 1 | OFF | ON
 *RST: 1

Example: See ["Programming Examples"](#) on page 771

Manual operation: See ["Sync. Output to External Trigger/Sync. Output to Trigger"](#) on page 112

[:SOURce<hw>]:BB:MCCW:TRIGger:RMODE?

Queries the status of signal generation for all trigger mode, if multi-carrier CW generation is on.

Return values:

<RMode> STOP | RUN

Example: See ["Programming Examples"](#) on page 771

Usage: Query only

Manual operation: See ["Running/Stopped"](#) on page 111

[:SOURce<hw>]:BB:MCCW:TRIGger:SLENgth <SLength>

Defines the length of the signal sequence to be output in the "Single" trigger mode.

Parameters:

<SLength> integer
 Range: 1 to 1000
 *RST: 1
 Default unit: samples

Example: See ["Programming Examples"](#) on page 771

Manual operation: See ["Signal Duration"](#) on page 111

[[:SOURce<hw>]:BB:MCCW:TRIGger:SOURce <Source>

Selects the trigger signal source and determines the way the triggering is executed. Provided are:

- Internal triggering by a command (INTernal)
- External trigger signal via one of the User x connectors
 - EGT1: External global trigger
 - EGC1: External global clock
- In master-slave mode, the external baseband synchronization signal (BBSY)
- EXTernal: Setting only
Provided only for backward compatibility with other Rohde & Schwarz signal generators.
The R&S SMBV100B accepts this value and maps it automatically as follows:
EXTernal = EGT1

Parameters:

<Source> INTernal|EGT1|EGC1|EXTernal|BBSY
*RST: INTernal

Example: See "[Programming Examples](#)" on page 771

Manual operation: See "[Source](#)" on page 111

[[:SOURce<hw>]:BB:MCCW:TRIGger[:EXTernal]:DELay <Delay>

Specifies the trigger delay.

Parameters:

<Delay> float
Range: 0 to 2147483647
Increment: 0.01
*RST: 0
Default unit: samples

Example: See "[Programming Examples](#)" on page 771

Manual operation: See "[\(Specified\) External Delay/\(Specified\) Trigger Delay](#)" on page 113

[[:SOURce<hw>]:BB:MCCW:TRIGger[:EXTernal]:INHibit <Inhibit>

Specifies the number of samples by which a restart is inhibited following an external trigger event.

Parameters:

<Inhibit> integer
Range: 0 to 21.47*clockRate
*RST: 0

Example: See "[Programming Examples](#)" on page 771

Manual operation: See ["External / Trigger Inhibit"](#) on page 112

[:SOURce<hw>]:BB:MCCW[:TRIGger]:SEQUence <Sequence>

Selects the trigger mode. For detailed description of the trigger modes, refer to ["Impact of the Trigger Modes on the Signal Generation"](#) on page 97.

Parameters:

<Sequence> AUTO | RETRigger | AAUto | ARETrigger | SINGLE
*RST: AUTO

Example: See ["Programming Examples"](#) on page 771

Manual operation: See ["Mode"](#) on page 110

Marker Settings

[:SOURce<hw>]:BB:MCCW:TRIGger:OUTPut<ch>:MODE	785
[:SOURce<hw>]:BB:MCCW:TRIGger:OUTPut<ch>:ONTime	785
[:SOURce<hw>]:BB:MCCW:TRIGger:OUTPut<ch>:OFFTime	785
[:SOURce<hw>]:BB:MCCW:TRIGger:OUTPut<ch>:PATTern	786
[:SOURce<hw>]:BB:MCCW:TRIGger:OUTPut<ch>:PULSe:DIVider	786
[:SOURce<hw>]:BB:MCCW:TRIGger:OUTPut<ch>:PULSe:FREQuency?	786
[:SOURce<hw>]:BB:MCCW:TRIGger:OUTPut<ch>:DELay	786

[:SOURce<hw>]:BB:MCCW:TRIGger:OUTPut<ch>:MODE <Mode>

Defines the signal for the selected marker output. For detailed description of the regular marker modes, refer to ["Marker Modes"](#) on page 94.

Parameters:

<Mode> REStart | PULSe | PATTern | RATio
*RST: REStart

Example: See ["Programming Examples"](#) on page 771

Manual operation: See ["Marker Mode"](#) on page 114

[:SOURce<hw>]:BB:MCCW:TRIGger:OUTPut<ch>:ONTime <OnTime>

[:SOURce<hw>]:BB:MCCW:TRIGger:OUTPut<ch>:OFFTime <OffTime>

Sets the number of samples in the off period of the corresponding marker signal.

Parameters:

<OffTime> integer
Range: 1 to 16777215
*RST: 1

Example: see ["Programming Examples"](#) on page 771

Manual operation: See ["Marker Mode"](#) on page 114

[:SOURce<hw>]:BB:MCCW:TRIGger:OUTPut<ch>:PATTern <Pattern>, <BitCount>

Defines the bit pattern used to generate the marker signal.

Parameters:

<Pattern> numeric
 *RST: #H2

<BitCount> integer
 0 = marker off, 1 = marker on
 Range: 1 to 64
 *RST: 2

Example: See "[Programming Examples](#)" on page 771.

Manual operation: See "[Marker Mode](#)" on page 114

[:SOURce<hw>]:BB:MCCW:TRIGger:OUTPut<ch>:PULSe:DIVider <Divider>

Sets the divider for pulse marker mode.

Parameters:

<Divider> integer
 Range: 2 to 1024
 *RST: 2

Example: See "[Programming Examples](#)" on page 771

Manual operation: See "[Marker Mode](#)" on page 114

[:SOURce<hw>]:BB:MCCW:TRIGger:OUTPut<ch>:PULSe:FREQuency?

Queries the pulse frequency of the pulsed marker signal.

Return values:

<Frequency> float
 Increment: 1E-3

Example: see "[Programming Examples](#)" on page 771

Usage: Query only

Manual operation: See "[Marker Mode](#)" on page 114

[:SOURce<hw>]:BB:MCCW:TRIGger:OUTPut<ch>:DELay <Delay>

Defines the delay between the signal on the marker outputs and the start of the signals, expressed as number of samples.

Parameters:

<Delay> float
 Range: 0 to 16777215
 Increment: 0.001
 *RST: 0

Example: See "Programming Examples" on page 771

Manual operation: See "Marker x Delay" on page 114

Clock Settings

[SOURce<hw>]:BB:MCCW:CLOCK:SOURce..... 787

[SOURce<hw>]:BB:MCCW:CLOCK:SOURce <Source>

Selects the clock source:

- INTernal: Internal clock reference

Parameters:

<Source> INTernal
 *RST: INTernal

Example: See "Programming Examples" on page 771.

Manual operation: See "Clock Source" on page 115

12.16.4.6 SOURce:AWGN Subsystem

The SOURce:AWGN subsystem contains the commands for setting the noise generator.

Required options

See Chapter 4.1.1, "Required Options", on page 229.

Programming Examples**Example: Generating a pure noise signal**

The following example generates a pure noise signal with specified bandwidth and noise level.

```
SOURce1:AWGN:MODE ONLY
SOURce1:AWGN:BWIDth 3840000
SOURce1:AWGN:BWIDth:RATio 2
SOURce1:AWGN:STATe ON
SOURce1:AWGN:BWIDth:NOISe?
// Response: 7680000
SOURce1:AWGN:DISP:MODE RFA
SOURce1:AWGN:POWer:NOISe -80
// SOURce1:POWer:LEVel:IMMediate:AMPlitude?
```

```
// Response: -80
SOURcel:AWGN:POWer:NOISe:TOTal?
```

Example: Generating a CW interferer signal

The following example generates a CW interferer signal with specified target frequency and level.

```
SOURcel:AWGN:MODE CW
SOURcel:AWGN:FREQuency:TARGet 20000000
SOURcel:AWGN:STATe ON
SOURcel:AWGN:FREQuency:RESult?

SOURcel:AWGN:POWer:RMODe CARRier
SOURcel:AWGN:CNRatio 10
SOURcel:AWGN:POWer:CARRier -80
// the Level display indicates the PEP of the carrier
// SOURcel:POWer:LEVel:IMMediate:AMPlitude?
// Response: -80
// Query the power of the interfering signal
SOURcel:AWGN:POWer:NOISe?
// Response: -90
SOURcel:AWGN:POWer:SUM?
// Response: -79.5860731484178
SOURcel:AWGN:POWer:SUM:PEP?
// Response: -80
```

Example: Generating an additive noise signal

The following example shows how to adjust the AWGN settings to generate a signal with the following characteristics:

- The carrier signal is an uplink EUTRA/LTE signal with:
 - "Channel Bandwidth = 1.4 GHz", i.e. "Occupied Bandwidth = 1.080 MHz"
 - "RF Frequency = 1.950 GHz"
 - "RF Level = -76 dBm"
- Required is an SNR of 12.7 dB

```
SOURcel:FREQuency:CW 1950000000
SOURcel:POWer:LEVel:IMMediate:AMPlitude -76

SOURcel:AWGN:MODE ADD
// set the system bandwidth to the occupied bandwidth
SOURcel:AWGN:BWIDth 1080000
SOURcel:AWGN:BWIDth:RATio 1.5
SOURcel:AWGN:STATe ON
SOURcel:AWGN:BWIDth:NOISe?
// Response: 1620000
```

```

SOURce1:AWGN:DISP:MODE RFA
SOURce1:AWGN:POWer:MODE CN
SOURce1:AWGN:POWer:RMODE CARRier
SOURce1:AWGN:BRATe?
// Response: 100000
SOURce1:AWGN:CNRatio 12.7
SOURce1:AWGN:ENRatio?
// Response: 23.0342375548695
SOURce1:AWGN:POWer:CARRier?
// Response: -76
// the Level display indicates the PEP of the carrier

// Query the resulting noise power, in the system and total bandwidth
SOURce1:AWGN:POWer:NOISe?
// Response: -88.7
SOURce1:AWGN:POWer:NOISe:TOTal?
// Response: -88.7
// Query the carrier+noise power and PEP
SOURce1:AWGN:POWer:SUM?
// Response: -75.7728170942726
SOURce1:AWGN:POWer:SUM:PEP?
// Response: -76

```

[SOURce<hw>]:AWGN:STATe.....	789
[SOURce<hw>]:AWGN:MODE.....	790
[SOURce<hw>]:AWGN:BWIDth.....	790
[SOURce<hw>]:AWGN:BWIDth:RATio.....	790
[SOURce<hw>]:AWGN:BWIDth:NOISe?.....	791
[SOURce<hw>]:AWGN:DISP:MODE.....	791
[SOURce<hw>]:AWGN:POWer:MODE.....	791
[SOURce<hw>]:AWGN:POWer:RMODE.....	791
[SOURce<hw>]:AWGN:BRATe.....	792
[SOURce<hw>]:AWGN:CNRatio.....	792
[SOURce<hw>]:AWGN:ENRatio.....	792
[SOURce<hw>]:AWGN:POWer:CARRier.....	792
[SOURce<hw>]:AWGN:POWer:NOISe.....	793
[SOURce<hw>]:AWGN:POWer:NOISe:TOTal?.....	793
[SOURce<hw>]:AWGN:POWer:SUM?.....	793
[SOURce<hw>]:AWGN:POWer:SUM:PEP?.....	794
[SOURce<hw>]:AWGN:FREQuency:TARGet.....	794
[SOURce<hw>]:AWGN:FREQuency:RESult?.....	794

[SOURce<hw>]:AWGN:STATe <State>

Activates or deactivates the AWGN generator.

Parameters:

<State> 0 | 1 | OFF | ON
 *RST: 0

Example: See [Example "Generating a pure noise signal"](#) on page 787.

Manual operation: See ["State"](#) on page 234

[[:SOURce<hw>]:AWGN:MODE <Mode>

Determines how the interfering signal is generated.

Parameters:

<Mode> ONLY | ADD | CW

ADD

The AWGN noise signal is added to the baseband signal.

ONLY

The pure AWGN noise signal is modulated to the carrier. The connection to the baseband is interrupted

CW

The sine interfering signal is added to the baseband signal.

*RST: ADD

Example: See [Example "Generating an additive noise signal"](#) on page 788

Manual operation: See ["Mode"](#) on page 234

[[:SOURce<hw>]:AWGN:BWIDth <BWidth>

Sets the system bandwidth.

Parameters:

<BWidth> float
 Range: 1000 to 80E6
 Increment: 100
 *RST: 3.84E6

Example: See [Example "Generating an additive noise signal"](#) on page 788.

Manual operation: See ["System Bandwidth"](#) on page 235

[[:SOURce<hw>]:AWGN:BWIDth:RATio <Ratio>

Sets the ratio of minimum real noise bandwidth to system bandwidth, see also ["Signal and noise parameters"](#) on page 230.

Parameters:

<Ratio> float
 Range: 1 to Max
 Increment: 0.1
 *RST: 1

Example: see [Example "Generating an additive noise signal"](#) on page 788

Manual operation: See ["Minimum Noise/System Bandwidth Ratio"](#) on page 235

[SOURce<hw>]:AWGN:BWIDth:NOISe?

Queries the real noise bandwidth.

Return values:

<Noise> float
 Range: 0 to 200E6
 Increment: 100
 *RST: 0

Example: See [Example "Generating an additive noise signal"](#) on page 788

Usage: Query only

Manual operation: See ["Noise Bandwidth"](#) on page 240

[SOURce<hw>]:AWGN:DISP:MODE <Mode>

Sets the output to that the AWGN settings are related.

Parameters:

<Mode> RFA | IQOUT1
 *RST: RF

Example: See [Example "Generating an additive noise signal"](#) on page 788.

Manual operation: See ["Show Powers for Output"](#) on page 236

[SOURce<hw>]:AWGN:POWer:MODE <Mode>

Selects the mode for setting the noise level.

Parameters:

<Mode> CN | SN | EN
 *RST: SN

Example: see [Example "Generating an additive noise signal"](#) on page 788

Manual operation: See ["Set Noise Power Via"](#) on page 237

[SOURce<hw>]:AWGN:POWer:RMODE <RMode>

Determines whether the carrier or the noise level is kept constant when the C/N value or Eb/N0 value is changed.

Parameters:

<RMode> CARRier | NOISe
 *RST: CARRier

Example: See [Example "Generating an additive noise signal"](#) on page 788

Manual operation: See ["Reference Mode"](#) on page 237

[[:SOURce<hw>]:AWGN:BRATe <BRate>

Sets the bit rate used for calculation of bit energy to noise power ratio.

Valid units are bps, kbps and mabps as well as b/s, kb/s and mab/s.

Parameters:

<BRate> float
 Range: 400 to depends on the installed options
 Increment: 0.001
 *RST: 100000

Example: see [Example "Generating an additive noise signal"](#) on page 788

Manual operation: See ["Bit Rate"](#) on page 237

[[:SOURce<hw>]:AWGN:CNRatio <CnRatio>

Sets the carrier/interferer ratio.

Parameters:

<CnRatio> float
 Range: -50 to 45
 Increment: 0.01
 *RST: 0

Example: See [Example "Generating an additive noise signal"](#) on page 788

Manual operation: See ["Carrier/Noise Ratio, Signal/Noise Ratio"](#) on page 237

[[:SOURce<hw>]:AWGN:ENRatio <EnRatio>

Sets the ratio of bit energy to noise power density.

Parameters:

<EnRatio> float
 Range: -50 to depends on the installed options
 Increment: 0.01
 *RST: 15.84
 Default unit: dB

Example: See [Example "Generating an additive noise signal"](#) on page 788

Manual operation: See [" \$E_b/N_0\$ "](#) on page 238

[[:SOURce<hw>]:AWGN:POWer:CARRier <Carrier>

Sets the carrier power.

Parameters:

<Carrier> float
 Increment: 0.01
 *RST: 0

Example: see [Example "Generating an additive noise signal"](#) on page 788

Manual operation: See ["Carrier Power, Signal Power"](#) on page 238

[:SOURce<hw>]:AWGN:POWer:NOISe <Noise>

Sets the power of the noise signal in the system respectively total bandwidth.

Parameters:

<Noise> float
Increment: 0.01

Example: see [Example "Generating an additive noise signal"](#) on page 788

Manual operation: See ["Noise Power \(System Bandwidth\), Interferer Power"](#) on page 239

[:SOURce<hw>]:AWGN:POWer:NOISe:TOTal?

Queries the noise level in the total bandwidth.

Return values:

<Total> float
Range: -145 to 20
Increment: 0.01
*RST: -30

Example: see [Example "Generating an additive noise signal"](#) on page 788

Usage: Query only

Manual operation: See ["Noise Power \(Total Bandwidth\)"](#) on page 240

[:SOURce<hw>]:AWGN:POWer:SUM?

Queries the overall power of the noise/interferer signal plus useful signal

Return values:

<Sum> float
Range: -145 to 20
Increment: 0.01
*RST: 0

Example: see [Example "Generating an additive noise signal"](#) on page 788

Usage: Query only

Manual operation: See ["Carrier + Noise Power, Signal + Noise Power \(System Bandwidth\), Carrier + Interferer Power, Signal + Interferer Power"](#) on page 240

[[:SOURce<hw>]:AWGN:POWer:SUM:PEP?

Queries the peak envelope power of the overall signal comprised of noise signal plus useful signal.

Return values:

<Pep> float
 Range: -145 to 20
 Increment: 0.01
 *RST: 0

Example: see [Example "Generating an additive noise signal"](#) on page 788

Usage: Query only

Manual operation: See ["Carrier + Noise PEP, Signal + Noise PEP \(Total Bandwidth\), Carrier + Interferer PEP, Signal + Interferer PEP"](#) on page 240

[[:SOURce<hw>]:AWGN:FREQuency:TARGet <Target>

Sets the desired frequency of the sine wave.

Parameters:

<Target> float
 Range: -40E6 to 40E6
 Increment: 0.01
 *RST: 0

Example: see [Example "Generating a CW interferer signal"](#) on page 788

Manual operation: See ["Target CW Frequency Offset"](#) on page 235

[[:SOURce<hw>]:AWGN:FREQuency:RESult?

Queries the actual frequency of the sine wave.

Return values:

<Result> float
 Range: -40E6 to 40E6
 Increment: 0.01
 *RST: 0

Example: see [Example "Generating a CW interferer signal"](#) on page 788

Usage: Query only

Manual operation: See ["Resulting CW Frequency Offset"](#) on page 240

12.16.4.7 SOURce:BB:IMPairment Subsystem

This subsystem contains the commands for the analog and digital I/Q impairments.

Suffixes

The following suffixes are used:

Suffix	Value range	Description
RF<ch>, IQOutput<ch>	1	IQ connector

Required options

See [Chapter 4.2.1, "Required Options"](#), on page 243.

[:SOURce]:BB:IMPairment:IQOutput<ch>:DELay	795
[:SOURce]:BB:IMPairment:RF<ch>:DELay	795
[:SOURce<hw>]:IQ:IMPairment:IQRatio[:MAGNitude]	796
[:SOURce]:BB:IMPairment:IQOutput<ch>:IQRatio[:MAGNitude]	796
[:SOURce]:BB:IMPairment:RF<ch>:IQRatio[:MAGNitude]	796
[:SOURce<hw>]:IQ:IMPairment:LEAKage:I	796
[:SOURce<hw>]:IQ:IMPairment:LEAKage:Q	796
[:SOURce]:BB:IMPairment:IQOutput<ch>:LEAKage:I	796
[:SOURce]:BB:IMPairment:IQOutput<ch>:LEAKage:Q	796
[:SOURce]:BB:IMPairment:RF<ch>:LEAKage:I	796
[:SOURce]:BB:IMPairment:RF<ch>:LEAKage:Q	796
[:SOURce<hw>]:IQ:IMPairment:QUADrature[:ANGLE]	797
[:SOURce]:BB:IMPairment:IQOutput<ch>:QUADrature[:ANGLE]	797
[:SOURce]:BB:IMPairment:RF<ch>:QUADrature[:ANGLE]	797
[:SOURce]:BB:IMPairment:IQOutput<ch>:SKEW	797
[:SOURce]:BB:IMPairment:RF<ch>:SKEW	797
[:SOURce<hw>]:IQ:IMPairment[:STATE]	798
[:SOURce]:BB:IMPairment:IQOutput<ch>:STATE	798
[:SOURce]:BB:IMPairment:RF<ch>:STATE	798
[:SOURce]:BB:IMPairment:IQOutput<ch>:POFFset	798
[:SOURce]:BB:IMPairment:RF<ch>:POFFset	798
[:SOURce<hw>]:BB:IMPairment:OPTimization:MODE	798

[:SOURce]:BB:IMPairment:IQOutput<ch>:DELay <Delay>

[:SOURce]:BB:IMPairment:RF<ch>:DELay <Delay>

Defines the time delay of both I and Q vectors between the marker signal at the marker outputs relative to the signal generation start.

A positive value means that the I and Q vectors delay relative to the marker/trigger and vice versa.

Table 12-2: Value range

Output	Min	Max	Resolution
RF<ch>	0	10E-6	1E-12
IQOutput<ch>	-500E-9	500E-9	1E-12
BBMM<ch>	-500E-9	500E-9	1E-12

Parameters:

<Delay> float
 Range: 0 to 10E-6
 Increment: 1E-12
 *RST: 0

Example: SOURce:BB:IMPairment:RF1:DELay 32.0E-9

Manual operation: See "[IQ Delay](#)" on page 248

[:SOURce<hw>]:IQ:IMPairment:IQRatio[:MAGNitude] <Magnitude>
[:SOURce]:BB:IMPairment:IQOutput<ch>:IQRatio[:MAGNitude] <IqRatio>
[:SOURce]:BB:IMPairment:RF<ch>:IQRatio[:MAGNitude] <IqRatio>

Sets the ratio of I modulation to Q modulation (amplification imbalance) of the corresponding digital channel.

Table 12-3: Value range

Impairments	Min [dB]	Max [dB]	Resolution
Digital	-4	4	0.0001
Analog	-1	1	0.0001

Parameters:

<IqRatio> float
 The setting value can be either in dB or %. An input in percent is rounded to the closest valid value in dB.
 Range: -4 to 4
 Increment: 1E-4
 *RST: 0
 Default unit: dB | PCT (setting command) / dB (result value)

Example: SOURce:BB:IMPairment:RF1:IQRatio:MAGNitude 10 PCT
 SOURce:BB:IMPairment:RF1:IQRatio:MAGNitude?
 // 0.848
 // the value is returned in dB

Manual operation: See "[Gain Imbalance](#)" on page 247

[:SOURce<hw>]:IQ:IMPairment:LEAKage:I <I>
[:SOURce<hw>]:IQ:IMPairment:LEAKage:Q <Q>
[:SOURce]:BB:IMPairment:IQOutput<ch>:LEAKage:I <I>
[:SOURce]:BB:IMPairment:IQOutput<ch>:LEAKage:Q <Q>
[:SOURce]:BB:IMPairment:RF<ch>:LEAKage:I <I>
[:SOURce]:BB:IMPairment:RF<ch>:LEAKage:Q <Q>

Determines the leakage amplitude of the I or Q signal component of the corresponding stream

Parameters:

<Q> float
 Range: -10 to 10
 Increment: 0.01
 *RST: 0

Example:

SOURce:BB:IMPairment:RF1:LEAKage:Q 4 PCT
 Sets the leakage for the Q-component to 4 percent.

Manual operation: See "[I/Q Offset](#)" on page 247

[:SOURce<hw>]:IQ:IMPairment:QUADrature[:ANGLE] <Angle>
[:SOURce]:BB:IMPairment:IQOutput<ch>:QUADrature[:ANGLE] <Angle>
[:SOURce]:BB:IMPairment:RF<ch>:QUADrature[:ANGLE] <Angle>

Sets a quadrature offset (phase angle) between the I and Q vectors deviating from the ideal 90 degrees.

A positive quadrature offset results in a phase angle greater than 90 degrees.

Table 12-4: Value range

Impairments	Min [dB]	Max [dB]	Resolution
Digital	-30	30	0.01
Analog	-10	10	0.01

Parameters:

<Angle> float
 Range: -30 to 30
 Increment: 0.01
 *RST: 0
 Default unit: DEG

Example:

SOURce:BB:IMPairment:RF1:QUADrature:ANGLE -5
 Sets the quadrature offset to -5 degrees.

Manual operation: See "[Quadrature Offset](#)" on page 248

[:SOURce]:BB:IMPairment:IQOutput<ch>:SKEW <Skew>
[:SOURce]:BB:IMPairment:RF<ch>:SKEW <Skew>

Sets a delay between the Q vector and the I vector of the corresponding stream.

Parameters:

<Skew> float
 Range: -500E-9 to 500E-9
 Increment: 1E-12
 *RST: 0

Manual operation: See "[Skew](#)" on page 248

```
[:SOURce<hw>]:IQ:IMPairment[:STATe] <State>
[:SOURce]:BB:IMPairment:IQOutput<ch>:STATe <State>
[:SOURce]:BB:IMPairment:RF<ch>:STATe <State>
```

Activates the impairment or correction values LEAKage, QUADrature and IQRatio for the corresponding stream.

Parameters:

```
<State>          0 | 1 | OFF | ON
*RST:           0
```

Example: SOURce1:BB:IMPairment:RF1:STATe ON
Activates digital impairment.

Manual operation: See "State" on page 247

```
[:SOURce]:BB:IMPairment:IQOutput<ch>:POFFset <PhaseOffset>
[:SOURce]:BB:IMPairment:RF<ch>:POFFset <PhaseOffset>
```

Adds an additional phase offset after the stream mapper.

You can shift the phase at the different stages in the signal generation flow, see:

- [\[:SOURce<hw>\]:BB:POFFset](#) on page 681

Parameters:

```
<PhaseOffset>   float
Range:          -999.99 to 999.99
Increment:      0.01
*RST:           0
```

Example: SOURce:BB:IMPairment:RF1:POFFset 0

Manual operation: See "Phase Offset" on page 248

```
[:SOURce<hw>]:BB:IMPairment:OPTimization:MODE <Mode>
```

Sets the optimization mode.

Parameters:

```
<Mode>          FAST | QHIGH
```

FAST
Optimization by compensation for I/Q skew.

QHIGH
Optimization by compensation for I/Q skew and frequency response correction.
This mode interrupts the RF signal. Do not use it in combination with the uninterrupted level settings and strictly monotone modes RF level modes.
(See [\[:SOURce<hw>\]:POWER:LBEHaviour](#) on page 863.)

```
*RST:          FAST
```

Example: SOURce1:IQ:SOURce BASeband
 SOURce1:BB:IMPairment:OPTimization:MODE FAST

Manual operation: See "Optimization Mode" on page 255

12.16.4.8 SOURce:BB:GRAPhics Subsystem

This subsystem contains the commands used to setup the graphical display.

Required options

See Chapter 7.1.1, "Required Options", on page 378.

[:SOURce<hw>]:BB:GRAPhics:MODE.....	799
[:SOURce<hw>]:BB:GRAPhics:SRATe:MODE.....	799
[:SOURce<hw>]:BB:GRAPhics:SRATe:USER.....	800
[:SOURce]:BB:GRAPhics:CLOSE.....	800
[:SOURce]:BB:GRAPhics:ADD.....	800
[:SOURce]:BB:GRAPhics:SOURce.....	800
[:SOURce]:BB:GRAPhics:FFTLen.....	801
[:SOURce]:BB:GRAPhics:FFTFscale.....	801
[:SOURce<hw>]:BB:GRAPhics:TRIGger:SOURce.....	801

[:SOURce<hw>]:BB:GRAPhics:MODE <Mode>

Selects the graphics mode of the graphical signal display.

Parameters:

<Mode> IQ | VECTor | CCDF | PSPectrum | CONSTellation | EYEI | EYEQ
 *RST: IQ

Example: BB:GRAP:MODE VECT
 Selects the vector diagram graphics mode.

Manual operation: See "Mode" on page 387

[:SOURce<hw>]:BB:GRAPhics:SRATe:MODE <Mode>

Sets how the time resolution of the signal is determined. Maximum resolution corresponds to a diagram covering the entire signal bandwidth. The higher the resolution is, the shorter the length of the displayed signal segment will be for the specified recording depth.

Parameters:

<Mode> AUTO | FULL | USER
 *RST: AUTO

Example: BB:GRAP:SRAT:MODE FULL
 Sets the sample rate mode.

Manual operation: See "Sample Rate Mode" on page 388

[[:SOURce<hw>]:BB:GRAPhics:SRATe:USER <User>

(Enabled for BB:GRAP:SRAT:MODE USER)

Selects the signal bandwidth for the diagram. The setting range moves between the minimum and maximum bandwidth which is possible for the selected graphical signal display. The selection is made graphically by moving the pointer.

Parameters:

<User> float
 Range: 0.01 to 100
 Increment: 0.01
 *RST: 10
 Default unit: PCT

Example: BB:GRAP:SRAT:USER 20
 sets the sample rate factor.

Example: BB:GRAP:SRAT:MODE USER
 sets the sample rate mode.

Manual operation: See ["Sample Rate"](#) on page 388

[[:SOURce]:BB:GRAPhics:CLOSe

Closes all graphical signal displays.

Usage: Event

Manual operation: See ["Remove"](#) on page 389

[[:SOURce]:BB:GRAPhics:ADD <Size>

Adds a graphical signal display (according to the current MODE, SOURce, SRATe:* and TRIGger:* settings).

Setting parameters:

<Size> MAXimized | MINimized

Usage: Setting only

Manual operation: See ["Add"](#) on page 388

[[:SOURce]:BB:GRAPhics:SOURce <Source>

Defines the signal acquisition point, that is the location in the signal flow where the displayed signal is tapped from.

See [Chapter 7.1.2.2, "Signal Acquisition Points"](#), on page 383.

Parameters:

<Source> STRA | BBA | RFA | BBIA

STRA
Stream A; input stream of the "IQ Stream Mapper"

BBA
Baseband signal

BBIA
Digital baseband input signals

RFA
RF signal

*RST: STRA

Manual operation: See "Source" on page 387

[[:SOURce]:BB:GRAPhics:FFTLen <Mode>

Sets the FFT size.

Parameters:

<Mode> LEN256 | LEN512 | LEN1024 | LEN2048 | LEN4096

*RST: LEN2048

Example: SOURce:BB:GRAPhics:FFTLen LEN2048

Manual operation: See "FFT Length" on page 387

[[:SOURce]:BB:GRAPhics:FFTFscale <State>

Defines the normalization of the power values in the power spectrum diagram.

Parameters:

<State> 0 | 1 | OFF | ON

1
Normalized power in dBFS

0
Shows power distribution in dB/Hz

*RST: 0

Example:

```
SOURce:BB:GRAPhics:FFTFscale PSpectrum
SOURce:BB:GRAPhics:FFTFscale 1
// the power spectrum shows the normalized power in dBFS
```

Manual operation: See "Full Scale (dBFS)" on page 387

[[:SOURce<hw>]:BB:GRAPhics:TRIGger:SOURce <Source>

Defines the trigger for the starting time of the graphic recording.

Parameters:

<Source> SOFTware | MARKer
 *RST: SOFTware

Example:

SOURce1:BB:GRAPhics:TRIGger:SOURce MARKer
 Sets the trigger source.

Manual operation: See ["Trigger Source"](#) on page 387

12.16.4.9 SOURce:BB:PROGress Subsystem General Commands

In the R&S SMBV100B, some calculation processes take longer time. While operating the instrument manually, you can observe the status of an initiated process by the busy indicator. The following commands fulfill the same task in the remote control operation.

Example: Querying the status of the Create Waveform file process

The following is an example on how to use these commands to retrieve information about how many percent of the initiated process are completed.

```
[ :SOURce<hw> ]:BB:PROGress:MCODer?.....802
[ :SOURce<hw> ]:BB:PROGress:MCODer:ARBitrary:MCARrier?.....802
[ :SOURce<hw> ]:BB:PROGress:MCODer:ARBitrary:WSEGment?.....802
```

```
[ :SOURce<hw> ]:BB:PROGress:MCODer?
[ :SOURce<hw> ]:BB:PROGress:MCODer:ARBitrary:MCARrier?
[ :SOURce<hw> ]:BB:PROGress:MCODer:ARBitrary:WSEGment?
```

Queries the status of an initiated process, like for example the calculation of a signal in accordance to a digital standard, or the calculation of a multi-carrier or multi-segment waveform file.

Return values:

<WSegment> integer
 Indicates the task progress in percent
 Range: 0 to 100
 *RST: 100

Example: See [Example "Querying the status of the Create Waveform file process"](#) on page 802

Usage: Query only

12.16.5 SOURce:CORRection Subsystem

The SOURce:CORRection subsystem contains the commands for defining correction values for external test assemblies.

You can acquire the correction values any time, regardless of the modulation settings of the generator. The correction is performed by adding the correction values to the output level of the respective RF frequency.

Determine the correction values in one of the following ways:

- Measure the RF output level at several frequency points and enter the value pairs manually in a table
- Connect an R&S NRP to the generator output signal and send the command [: SOURce<hw>] : CORRection : CSET : DATA [: SENSor<ch>] [: POWer] : SONCe to fill the table automatically.

Correction values can be stored in files with the predefined file extension *.uco.

Refer to [Chapter 12.6.2, "Accessing Files in the Default or in a Specified Directory"](#), on page 588 for general information on file handling in the default and in a specific directory.

Programming example

The examples in this section assume that:

- The files are stored in the default directory.
- *RST does not affect data lists.

Example: Create a table with user-defined correction values for the RF level

The following example shows a command sequence to create and activate a list for assigning level correction values to arbitrary RF frequencies. Further hardware settings are not considered.

```
// Reset the instrument to start from an initial state
// Query the available user correction list files in the default directory
// Select a file or create a new one
// *****
*RST; *CLS
SOURcel:CORRection:CSET:CATalog?
// Response: shows the name of available user correction files (if applicable)
// Select a file
SOURcel:CORRection:CSET:SElect "/var/user/ucor1"
// Create a new file (if not existing)
SOURcel:CORRection:CSET:SElect "/var/user/ucor2"

// Enter the frequency/level value pairs in the table;
// existing data is overwritten
// Query the number of frequency/power entries in the selected list
SOURcel:CORRection:CSET:DATA:FREQuency 100MHz,110MHz,120MHz,130MHz,140MHz,150MHz
SOURcel:CORRection:CSET:DATA:POWer -10,-7.5,-5.0,-2.5,0,2.5
SOURcel:CORRection:CSET:DATA:FREQuency:POINTs?
// 6
SOURcel:CORRection:CSET:DATA:POWer:POINTs?
// 6

// Enable user correction mode and RF output
SOURcel:CORRection:STATe 1
OUTPut1:STATe ON
```

```
// Query the currently used correction value
SOURcel:CORRection:VALue?
// -2.5

// Delete a user correction file
SOURcel:CORRection:CSET:DELEte "/var/user/ucor1.uco"
```

Example: Fill user correction data with sensor

The following example shows a command sequence to fill a user correction list automatically supported by a connected R&S NRP.

```
// Fill a user correction list with the level values
// measured by an R&S NRP,
// store the data in a file and enable multi level user correction.

*RST; *CLS

SOURcel:CORRection:CSET:SElect "/var/user/Ucor1_AutoFill.uco"
SOURcel:CORRection:CSET:DATA:FREQuency 100MHz,110MHz,120MHz,130MHz,140MHz,150MHz
SOURcel:CORRection:ZERoing:STATe 1
SOURcel:CORRection:CSET:DATA:SENSor1:POWer:SONce
// Query the number of automatically filled correction level values
SOURcel:CORRection:CSET:DATA:POWer:POINTs?
// 6
SOURcel:CORRection:STATe 1

// Query the correction value at a certain frequency
FREQ 120000000
SOURcel:CORRection:VALue?
// -52.13
```

Example: User correction data exchange

The following example shows a command sequence to export a user correction list (here the list created with the example before) into an ASCII file. Further hardware settings are not considered.

```
// Select a user correction file for exporting to file in ASCII format
// Set ASCII data parameters
// Set the ASCII file extension, the decimal separator
// and the column separator for the ASCII data
SOURcel:CORRection:DEXChange:AFILe:CATalog?
// my_ucor
SOURcel:CORRection:CSET:CATalog?
// ucor1,Ucor1_AutoFill
SOURcel:CORRection:CSET:SElect "/var/user/Ucor1_AutoFill.uco"
SOURcel:CORRection:DEXChange:AFILe:EXTension CSV
SOURcel:CORRection:DEXChange:AFILe:SEParator:DECimal DOT
SOURcel:CORRection:DEXChange:AFILe:SEParator:COLumn COMMa
```

```
// Select source and destination
SOURcel:CORRection:DEXChange:AFILe:SElect "/var/user/ucor2ASCII"

// Export the user correction data into the ASCII file
SOURcel:CORRection:DEXChange:MODE EXPort
SOURcel:CORRection:DEXChange:EXECute

// Query the available ASCII files with extension .csv
SOURcel:CORRection:DEXChange:AFILe:CATalog?
// ucor2ASCII,my_ucor

// Import a user correction ASCII file
SOURcel:CORRection:DEXChange:MODE IMPort
SOURcel:CORRection:DEXChange:AFILe:SElect "/var/user/my_ucor"
SOURcel:CORRection:DEXChange:EXECute
```

- [Correction Settings](#).....805
- [Correction Data Exchange](#).....808
- [Frequency Response Commands](#).....810

12.16.5.1 Correction Settings

[:SOURce<hw>]:CORRection:CSET:DATA:FREQUency <Frequency>

Enters the frequency value in the table selected with `[:SOURce<hw>] :CORRection:CSET [:SElect]`.

Parameters:

<Frequency> Frequency#1[, Frequency#2, ...]
String of values with default unit Hz.

Example: See [Example "Create a table with user-defined correction values for the RF level"](#) on page 803 .

Manual operation: See ["Edit List Mode Data"](#) on page 315

[:SOURce<hw>]:CORRection:CSET:DATA:POWer <Power>

Enters the level values to the table selected with `[:SOURce<hw>] :CORRection:CSET [:SElect]`.

Parameters:

<Power> Power#1[, Power#2, ...]
String of values with default unit dB.
*RST: 0

Example: See [Example "Create a table with user-defined correction values for the RF level"](#) on page 803 .

Manual operation: See ["Edit List Mode Data"](#) on page 315

[[:SOURce<hw>]:CORRection:CSET:DATA:FREQUency:POINts?

[[:SOURce<hw>]:CORRection:CSET:DATA:POWer:POINts?

Queries the number of frequency/level values in the selected table.

Return values:

<Points> integer
 Range: 0 to 10000
 *RST: 0

Example: See [Example "Create a table with user-defined correction values for the RF level"](#) on page 803 .

Usage: Query only

[[:SOURce<hw>]:CORRection:CSET:DATA[:SENSor<ch>][:POWer]:SONCe

Fills the selected user correction table with the level values measured by the power sensor for the given frequencies.

To select the used power sensor set the suffix in key word `SENSe`.

Example: See [Example "Fill user correction data with sensor"](#) on page 804.

Usage: Event

Manual operation: See "[Fill User Correction Data with Sensor](#)" on page 360

[[:SOURce<hw>]:CORRection:CSET[:SELEct] <Filename>

Selects or creates a file for the user correction data.

If the file with the selected name does not exist, a new file is created.

Parameters:

<Filename> string
 Filename or complete file path; file extension can be omitted.

Example: See [Example "Create a table with user-defined correction values for the RF level"](#) on page 803 .

Manual operation: See "[UCOR Data](#)" on page 356

[[:SOURce<hw>]:CORRection:VALue?

Queries the current value for user correction.

Return values:

<Value> float
 Range: -100 to 100
 Increment: 0.01
 *RST: 0

Example: See [Example "Create a table with user-defined correction values for the RF level"](#) on page 803 .

Usage: Query only

Manual operation: See ["User Correction"](#) on page 356

[:SOURce<hw>]:CORRection:ZERoing:STATe <State>

Activates the zeroing procedure before filling the user correction data acquired by a sensor.

Parameters:

<State> 0 | 1 | OFF | ON
*RST: 1

Example: See [Example "Fill user correction data with sensor"](#) on page 804.

Manual operation: See [" Fill User Correction Data with Sensor"](#) on page 360

[:SOURce<hw>]:CORRection:CSET:DATA[:SENSor<ch>][:POWER]:SONCe

Fills the selected user correction list with the level values measured by the power sensor for the given frequencies.

Suffix:

SENSor<ch> Defines the used power sensor, i.e. the sensor whose values are used.

Example: See [Example "Fill user correction data with sensor"](#) on page 804.

Usage: Event

[:SOURce<hw>]:CORRection[:STATe] <State>

Activates user correction with the currently selected table.

Parameters:

<State> 0 | 1 | OFF | ON
*RST: 0

Example: See [Example "Create a table with user-defined correction values for the RF level"](#) on page 803 .

Manual operation: See ["State"](#) on page 356

[:SOURce]:CORRection:CSET:CATalog?

Queries a list of available user correction tables.

Return values:

<Catalog> string
List of list filenames, separated by commas

Example: See [Example "Create a table with user-defined correction values for the RF level"](#) on page 803 .

Usage: Query only

Manual operation: See ["UCOR Data"](#) on page 356

[:SOURce]:CORRection:CSET:DELeTe <Filename>

Deletes the specified user correction list file.

Setting parameters:

<Filename> string
Filename or complete file path; file extension is optional.

Example: See [Example "Create a table with user-defined correction values for the RF level"](#) on page 803 .

Usage: Setting only

Manual operation: See ["UCOR Data"](#) on page 356

12.16.5.2 Correction Data Exchange

With the following commands, you can configure user correction lists and export or import them accordingly.

[:SOURce<hw>]:CORRection:DEXChange:AFILe:CATalog?

Queries the available ASCII files for export or import of user correction data in the current or specified directory.

Return values:

<Catalog> string
List of ASCII files *.txt or *.csv, separated by commas.

Example: See [Example "Create a table with user-defined correction values for the RF level"](#) on page 803 .

Usage: Query only

Manual operation: See ["Select \(ASCII\) Source/Select \(ASCII\) Destination"](#) on page 313

[:SOURce<hw>]:CORRection:DEXChange:AFILe:EXTension <Extension>

Determines the extension of the ASCII files for file import or export, or to query existing files.

Parameters:

<Extension> TXT | CSV
 *RST: TXT

Example: See [Example "User correction data exchange"](#) on page 804 .

Manual operation: See ["ASCII File Settings"](#) on page 313

[[:SOURce<hw>]:CORRection:DEXChange:AFILe:SElect <Filename>

Selects the ASCII file to be imported or exported.

Parameters:

<Filename> string
 Filename or complete file path; file extension can be omitted.

Example: See [Example "User correction data exchange"](#) on page 804 .

Manual operation: See ["Select \(ASCII\) Source/Select \(ASCII\) Destination"](#) on page 313

[[:SOURce<hw>]:CORRection:DEXChange:AFILe:SEParator:COLumn <Column>

Selects the separator between the frequency and level column of the ASCII table.

Parameters:

<Column> TABulator | SEMicolon | COMMa | SPACe
 *RST: COMMa

Example: See [Example "User correction data exchange"](#) on page 804 .

Manual operation: See ["ASCII File Settings"](#) on page 313

[[:SOURce<hw>]:CORRection:DEXChange:AFILe:SEParator:DECimal <Decimal>

Sets the decimal separator used in the ASCII data between '.' (decimal point) and ',' (comma) with floating-point numerals.

Parameters:

<Decimal> DOT | COMMa
 *RST: DOT

Example: See [Example "User correction data exchange"](#) on page 804 .

Manual operation: See ["ASCII File Settings"](#) on page 313

[[:SOURce<hw>]:CORRection:DEXChange:EXECute

Executes the import or export of the selected correction list, according to the previously set transfer direction with command `[[:SOURce<hw>]:CORRection:DEXChange:MODE`.

Example: See [Example "User correction data exchange"](#) on page 804 .

Usage: Event

Manual operation: See "Import / Export" on page 313

[:SOURce<hw>]:CORRection:DEXChange:MODE <Mode>

Determines import or export of a user correction list.

Specify the source or destination file with the command [:SOURce<hw>] :
CORRection:DEXChange:SElect.

Parameters:

<Mode> IMPort | EXPort
*RST: IMPort

Example: See Example "User correction data exchange" on page 804 .

Manual operation: See " Mode " on page 312

[:SOURce<hw>]:CORRection:DEXChange:SElect <Filename>

Selects the ASCII file for import or export, containing a user correction list.

Parameters:

<Filename> string
Filename or complete file path; file extension can be omitted.

Example: See Example "User correction data exchange" on page 804 .

Manual operation: See "Select Source/Select ASCII Destination" on page 313

12.16.5.3 Frequency Response Commands

This section lists the frequency response commands related to the I/Q modulator.

Example: Enabling high-quality optimization

```
SOURce1:CORRection:FRESponse:RF:OPTimization:MODE QHIG
SOURce1:CORRection:FRESponse:RF:OPTimization:BANDwidth:MODE AUTO
SOURce1:CORRection:FRESponse:RF:OPTimization:BANDwidth:VALue?
// 160000000
SOURce1:CORRection:FRESponse:RF:OPTimization:LOCAl
```

[:SOURce<hw>]:CORRection:FRESponse:RF:OPTimization:MODE.....	810
[:SOURce<hw>]:CORRection:FRESponse:RF:OPTimization:BANDwidth:MODE.....	811
[:SOURce<hw>]:CORRection:FRESponse:RF:OPTimization:BANDwidth[:VALue].....	811
[:SOURce<hw>]:CORRection:FRESponse:RF:OPTimization:LOCAl.....	812

**[:SOURce<hw>]:CORRection:FRESponse:RF:OPTimization:MODE
<FreqRespOptMode>**

Sets the optimization mode.

The value selected here is used also as optimization mode in the I/Q modulator, and vice versa.

For details, see R&S SMBV100B User Manual.

Parameters:

<FreqRespOptMode> FAST | QHIGh

FAST

Optimization by compensation for I/Q skew.

QHIGh

Optimization by compensation for I/Q skew and frequency response correction.

This mode interrupts the RF signal. Do not use it in combination with the uninterrupted level settings and strictly monotone modes RF level modes

*RST: FAST

Example: See [Example "Enabling high-quality optimization"](#) on page 810.

[:SOURce<hw>]:CORRection:FRESponse:RF:OPTimization:BANDwidth:MODE
<FreqRespOptBwMo>

For [:SOURce<hw>]:CORRection:FRESponse:RF:OPTimization:MODE QHIG|QHT, sets how the signal bandwidth is estimated: automatically or manually with the command [:SOURce<hw>]:CORRection:FRESponse:RF:OPTimization:BANDwidth[:VALue].

Parameters:

<FreqRespOptBwMo>AUTO | MANual

*RST: AUTO

Example: See [Example "Enabling high-quality optimization"](#) on page 810.

Manual operation: See ["Optimization Bandwidth"](#) on page 257

[:SOURce<hw>]:CORRection:FRESponse:RF:OPTimization:BANDwidth[:VALue]
<FreqRespOptBwVa>

Sets the signal compensation bandwidth for [:SOURce<hw>]:CORRection:FRESponse:RF:OPTimization:BANDwidth:MODEMAN.

Parameters:

<FreqRespOptBwVa> integer

Range: depends on options to depends on options

*RST: depends on options

Example: See [Example "Enabling high-quality optimization"](#) on page 810.

Manual operation: See ["Bandwidth"](#) on page 257

[:SOURce<hw>]:CORRection:FRESponse:RF:OPTimization:LOCal

For [:SOURce<hw>]:CORRection:FRESponse:RF:OPTimization:MODEQHIG, triggers optimization for the current settings.

Example: See [Example "Enabling high-quality optimization"](#) on page 810.

Usage: Event

Manual operation: See ["Optimize for current setting"](#) on page 257

12.16.6 SOURce:FREQuency Subsystem

The SOURce:FREQuency subsystem contains the commands used to define the frequency settings for the RF sources and sweeps.

Example: Frequency configuration

```
SOURce1:FREQuency:MODE CW
SOURce1:FREQuency:CW 6000000000
SOURce1:FREQuency:OFFSet 2000000000
SOURce1:FREQuency:MULTiplier 1.5
SOURce1:FREQuency:CW?
// 11000000000

// SOURce1:FREQuency:STEP:MODE USER
// SOURce1:FREQuency:STEP:INCRement 1000000
// SOURce1:FREQuency:CW UP

SOURce1:PHASe 2
SOURce1:PHASe:REFerence
```

Example: Set up of LO coupling and LO level adjustment with three Rohde & Schwarz signal generators

This example shows the command sequences for coupling the oscillator signal of three signal generators connected according to the setup on [Figure 12-11](#).

Connect the instruments in a daisy-chain regarding the LO signal:

- Connect the LO Out of the first generator with LO In of the second
- Connect the LO Out of the second generator with LO In of the third.

The frequency is assumed to be 5 GHz.

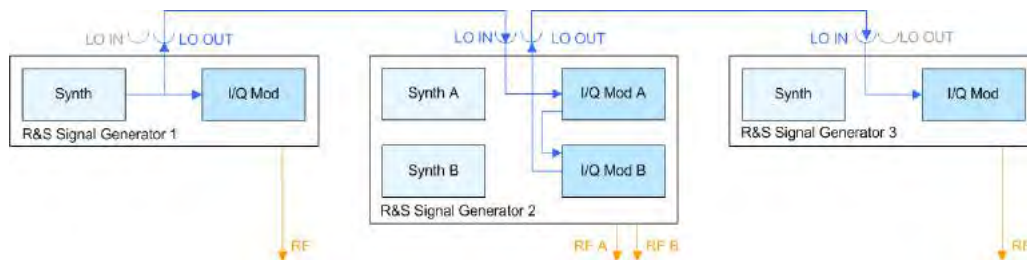

Figure 12-11: Set up of LO coupling with three Rohde & Schwarz signal generators

Signal generator#1 = One-path instrument, uses its internal oscillator signal.

Signal generator#2 = Two-paths instrument; receives the LO signal from the first instrument and assigns it to both paths

Signal generator#3 = One-path instrument; receives the LO signal from the second instrument

```
// *****
// Address and reset the first instrument
// *****
*RST; *CLS

// *****
// Configure the oscillator signal of the first instrument
// *****
SOURCE:FREQUENCY 5 GHz
SOURCE:FREQUENCY:LOSCillator:MODE INTERNAL
SOURCE:FREQUENCY:LOSCillator:OUTPut:STATE ON
SOURCE:FREQUENCY:LOSCillator:OUTPut:FREQUENCY?
// Response: 100000000

// *****
// Address and reset the second instrument, e.g. a R&S SMW
// *****
*RST; *CLS

// *****
// Configure the oscillator signal of the second instrument
// *****
SOURCE1:FREQUENCY 5 GHz
SOURCE1:FREQUENCY:LOSCillator:MODE ECoupled
SOURCE1:FREQUENCY:LOSCillator:OUTPut:STATE ON
```

```

// *****
// If the attenuation between the interconnection LO OUT and LO IN is
// greater than 1 dB at the oscillator frequency,
// we recommend that you perform the LO level adjustment
// *****
:CALibration:LOSCillator:COupling:LOCAL?

// *****
// Address and reset the third instrument
// *****
*RST; *CLS

// *****
// Configure the oscillator signal of the third next instrument
// *****
SOURce:FREQuency 5 GHz
SOURce:FREQuency:LOSCillator:MODE EXTernal
SOURce:FREQuency:LOSCillator:OUTPut:STATe OFF

```

See also:

- ["To configure LO coupling with cascaded instruments to achieve phase coherence" on page 282](#)

[:SOURce<hw>]:FREQuency:LOSCillator:INPut:FREQuency?	814
[:SOURce<hw>]:FREQuency:LOSCillator:MODE	815
[:SOURce<hw>]:FREQuency:LOSCillator:OUTPut:FREQuency?	815
[:SOURce<hw>]:FREQuency:LOSCillator:OUTPut:STATe	815
[:SOURce<hw>]:FREQuency:MODE	815
[:SOURce<hw>]:FREQuency[:CW FIXed]	816
[:SOURce<hw>]:FREQuency[:CW FIXed]:RCL	817
[:SOURce<hw>]:FREQuency:MANual	817
[:SOURce<hw>]:FREQuency:MULTIplier	818
[:SOURce<hw>]:FREQuency:OFFSet	818
[:SOURce<hw>]:FREQuency:CENTer	819
[:SOURce<hw>]:FREQuency:SPAN	819
[:SOURce<hw>]:FREQuency:START	819
[:SOURce<hw>]:FREQuency:STOP	820
[:SOURce<hw>]:FREQuency:STEP:MODE	820
[:SOURce<hw>]:FREQuency:STEP[:INCRement]	821

[\[:SOURce<hw>\]:FREQuency:LOSCillator:INPut:FREQuency?](#)

Queries the required external reference frequency.

Return values:

<Frequency>	float
	Range: 100E3 to 20E9
	Increment: 0.01
	*RST: 0

Example:

See [Example "Set up of LO coupling and LO level adjustment with three Rohde & Schwarz signal generators"](#) on page 813.

Usage: Query only
Manual operation: See ["Mandatory LO IN Frequency"](#) on page 282

[[:SOURce<hw>]:FREQUENCY:LOSCillator:MODE <Mode>

Selects the mode of the local oscillator coupling.

Parameters:

<Mode> INTernal | EXTernal
 *RST: INTernal

Example: See [Example "Set up of LO coupling and LO level adjustment with three Rohde & Schwarz signal generators"](#) on page 813.

Manual operation: See ["Mode"](#) on page 281

[[:SOURce<hw>]:FREQUENCY:LOSCillator:OUTPut:FREQUENCY?

Queries the current frequency of the local oscillator at the [LO Out] connector.

Return values:

<Frequency> float
 Range: 100E3 to 20E9
 Increment: 0.01
 *RST: 0

Example: See [Example "Set up of LO coupling and LO level adjustment with three Rohde & Schwarz signal generators"](#) on page 813.

Usage: Query only

Manual operation: See ["LO OUT Frequency"](#) on page 282

[[:SOURce<hw>]:FREQUENCY:LOSCillator:OUTPut:STATE <State>

Activates the LO output.

Parameters:

<State> 0 | 1 | OFF | ON
 *RST: 0

Example: See [Example "Set up of LO coupling and LO level adjustment with three Rohde & Schwarz signal generators"](#) on page 813.

Manual operation: See ["Out State"](#) on page 281

[[:SOURce<hw>]:FREQUENCY:MODE <Mode>

Sets the frequency mode for generating the RF output signal. The selected mode determines the parameters to be used for further frequency settings.

Parameters:

<Mode>

CW | FIXed | SWEep | LIST

CW|FIXed

Sets the fixed frequency mode. CW and FIXed are synonyms. The instrument operates at a defined frequency, set with command `[:SOURce<hw>] :FREQuency [:CW | FIXed]`.

SWEep

Sets sweep mode.

The instrument processes frequency (and level) settings in defined sweep steps.

Set the range and current frequency with the commands:

`[:SOURce<hw>] :FREQuency:START` on page 819 and `[:SOURce<hw>] :FREQuency:STOP` on page 820,

`[:SOURce<hw>] :FREQuency:SPAN` on page 819,

`[:SOURce<hw>] :FREQuency:CENTer` on page 819,

`[:SOURce<hw>] :FREQuency:MANual` on page 817

`[:SOURce<hw>] :FREQuency:MANual` on page 817

LIST

Sets list mode.

The instrument processes frequency and level settings by means of values loaded from a list.

To configure list mode settings, use the commands of the [Chapter 12.16.11, "SOURce:LIST Subsystem"](#), on page 842.

*RST: CW

Example:

See [Example "Frequency configuration"](#) on page 812

Example:

See [Example "Setup an RF frequency or power sweep"](#) on page 875

Manual operation:

See ["State \(RF frequency sweep\)"](#) on page 301

`[:SOURce<hw>] :FREQuency [:CW | FIXed] <Fixed>`

Sets the frequency of the RF output signal in the selected path.

The effect depends on the selected mode:

- In CW mode (`FREQ:MODE CW | FIXed`), the instrument operates at a fixed frequency.
- In sweep mode (`FREQ:MODE SWE`), the value applies to the sweep frequency. The instrument processes the frequency settings in defined sweep steps.
- In user mode (`FREQ:STEP:MODE USER`), you can vary the current frequency step by step.

Parameters:

<Fixed>

float

The following settings influence the value range:

An offset set with the command `[:SOURce<hw>] :FREQuency:OFFSet`**Numerical value**

Sets the frequency in CW and sweep mode

UP|DOWN

Varies the frequency step by step in user mode.

The frequency is increased or decreased by the value set with the command `[:SOURce<hw>] :FREQuency:STEP [:INCRement]`.

Range: (RFmin + OFFSet) to (RFmax + OFFSet)

*RST: 100 MHz

Example:See [Example "Frequency configuration"](#) on page 812**Example:**See [Example "Setup an RF frequency or power sweep"](#) on page 875**Manual operation:** See ["Frequency"](#) on page 264**[:SOURce<hw>] :FREQuency [:CW|FIXed] :RCL <Rcl>**Set whether the RF frequency value is retained or taken from a loaded instrument configuration, when you recall instrument settings with command `*RCL`.**Parameters:**

<Rcl>

INCLude | EXCLude

INCLude

Takes the frequency value of the loaded settings.

EXCLude

Retains the current frequency when an instrument configuration is loaded.

*RST: INCLude

Example:`SOURce1:FREQuency:CW:RCL INCLude`**Manual operation:** See ["Exclude Frequency"](#) on page 455**[:SOURce<hw>] :FREQuency:MANual <Manual>**Sets the frequency and triggers a sweep step manually if `SWEep:MODE MAN`.

Parameters:

<Manual>

float

You can select any frequency within the setting range, where:

START is set with [:SOURce<hw>]:FREQuency:START

STOP is set with [:SOURce<hw>]:FREQuency:STOP

OFFSet is set with [:SOURce<hw>]:FREQuency:OFFSet

Range: (START + OFFSet) to (STOP + OFFSet)

Increment: 0.01Hz

*RST: 100 MHz

Default unit: Hz

Example:

See [Example "Setup an RF frequency or power sweep"](#) on page 875

Manual operation: See ["Current Frequency"](#) on page 302

[[:SOURce<hw>]:FREQuency:MULTiplier <Multiplier>

Sets the multiplication factor $N_{\text{FREQ:MULT}}$ of a subsequent downstream instrument.

The parameters offset $f_{\text{FREQ:OFFSer}}$ and multiplier $N_{\text{FREQ:MULT}}$ affect the frequency value set with the command [FREQ](#).

The query [FREQ?](#) returns the value corresponding to the formula:

$$f_{\text{FREQ}} = f_{\text{RFout}} * N_{\text{FREQ:MULT}} + f_{\text{FREQ:OFFSer}}$$

See ["RF frequency and level display with a downstream instrument"](#) on page 262.

Parameters:

<Multiplier>

float

Range: 1 to dynamic

Increment: 0.001

*RST: 1

Example:

See [Example "Frequency configuration"](#) on page 812

Manual operation: See ["Multiplier"](#) on page 265

[[:SOURce<hw>]:FREQuency:OFFSet <Offset>

Sets the frequency offset $f_{\text{FREQ:OFFSet}}$ of a downstream instrument.

The parameters offset $f_{\text{FREQ:OFFSer}}$ and multiplier $N_{\text{FREQ:MULT}}$ affect the frequency value set with the command [FREQ](#).

The query [FREQ?](#) returns the value corresponding to the formula:

$$f_{\text{FREQ}} = f_{\text{RFout}} * N_{\text{FREQ:MULT}} + f_{\text{FREQ:OFFSer}}$$

See ["RF frequency and level display with a downstream instrument"](#) on page 262.

Note: The offset also affects RF frequency sweep.

Parameters:

<Offset> float
 Increment: 0.01
 *RST: 0

Example: See [Example "Frequency configuration"](#) on page 812

Manual operation: See ["Offset"](#) on page 265

[:SOURce<hw>]:FREQUENCY:CENTer <Center>

Sets the center frequency of the sweep.

See [Chapter 6.10.2.1, "Correlating Parameters in Sweep Mode"](#), on page 294.

Parameters:

<Center> float
 Range: 300 kHz to RFmax
 Increment: 0.01 Hz
 *RST: 300E6
 Default unit: Hz

Example: See [Example "Setup an RF frequency or power sweep"](#) on page 875

Manual operation: See ["Center Frequency"](#) on page 306

**[:SOURce<hw>]:FREQUENCY:SPAN **

Sets the span of the frequency sweep range.

See [Chapter 6.10.2.1, "Correlating Parameters in Sweep Mode"](#), on page 294.

Parameters:

 float
 Full frequency range
 Increment: 0.01
 *RST: 400E6

Example: See [Example "Setup an RF frequency or power sweep"](#) on page 875

Manual operation: See ["Span"](#) on page 306

[:SOURce<hw>]:FREQUENCY:STARt <Start>

Sets the start frequency for the RF sweep.

See [Chapter 6.10.2.1, "Correlating Parameters in Sweep Mode"](#), on page 294.

Parameters:

<Start> float
 Range: 300kHz to RFmax
 Increment: 0.01Hz
 *RST: 100 MHz

Example: See [Example "Setup an RF frequency or power sweep"](#) on page 875

Manual operation: See "[Start Frequency/Stop Frequency](#)" on page 306

[:SOURce<hw>]:FREQUENCY:STOP <Stop>

Sets the stop frequency range for the RF sweep.

See [Chapter 6.10.2.1, "Correlating Parameters in Sweep Mode"](#), on page 294.

Parameters:

<Stop> float
 Range: 300kHz to RFmax
 Increment: 0.01Hz
 *RST: 500 MHz
 Default unit: Hz

Example: See [Example "Setup an RF frequency or power sweep"](#) on page 875

Manual operation: See "[Start Frequency/Stop Frequency](#)" on page 306

[:SOURce<hw>]:FREQUENCY:STEP:MODE <Mode>

Defines the type of step size to vary the RF frequency at discrete steps with the commands [FREQ UP](#) or [FREQ DOWN](#).

Parameters:

<Mode> DECimal | USER
DECimal
 Increases or decreases the level in steps of ten.
USER
 Increases or decreases the level in increments, set with the command [FREQ:STEP\[:INCR\]](#).
 *RST: DECimal

Example:

```
// increasing the RF frequency with a step size of 50 KHz
SOURce1:FREQUENCY:STEP 50E3
SOURce1:FREQUENCY:STEP:MODE USER
SOURce1:FREQUENCY:CW UP
```

Manual operation: See "[Variation Active](#)" on page 265

[[:SOURce<hw>]:FREQUENCY:STEP[:INCREMENT] <Increment>

Sets the step width.

You can use this value to vary the RF frequency with command [FREQ UP](#) or [FREQ DOWN](#), if you have activated [FREQ:STEP:MODE USER](#).

Note: This value also applies to the step width of the rotary knob on the instrument and, in user-defined step mode, increases or decreases the frequency.

Parameters:

<Increment> float
 Range: 0 Hz to RFmax - 100 kHz
 Increment: 0.01 Hz
 *RST: 1E6

Example: See [Example "Frequency configuration"](#) on page 812

Manual operation: See ["Variation Step"](#) on page 265

12.16.7 SOURce:INPut Subsystem

The `SOURce:INPut` subsystem contains the commands for configuring the inputs for external modulation signals. The instrument trigger setting influences all sweeps and is effective in the List mode (Instrument Trigger).

[\[:SOURce<hw>\]:INPut:MODext:COUPling](#).....821
[\[:SOURce<hw>\]:INPut:MODext:IMPedance<ch>](#).....821
[\[:SOURce\]:INPut:TRIGger:SLOPe](#)..... 822

[[:SOURce<hw>]:INPut:MODext:COUPling <Coupling>

Selects the coupling mode for an externally applied modulation signal.

Parameters:

<Coupling> AC | DC
AC
 Passes the AC signal component of the modulation signal.
DC
 Passes the modulation signal with both components, AC and DC.
 *RST: AC

Example: `SOURce1:INPut:MODext:COUPling AC`
`SOURce1:INPut:MODext:IMPedance G50`

Manual operation: See ["Coupling \(AC/DC\)"](#) on page 339

[[:SOURce<hw>]:INPut:MODext:IMPedance<ch> <Impedance>

Sets the impedance for the externally supplied modulation signal.

Parameters:

<Impedance> G50 | G600 | HIGH
 G50 = 50 Ohm to ground
 G600 = 600 Ohm to ground
 HIGH = 100 kOhm to ground
 *RST: HIGH

Example:

See `[:SOURce<hw>] :INPut:MODext:COUPling`
 on page 821.

Manual operation: See "[Impedance](#)" on page 340

[:SOURce] :INPut:TRIGger:SLOPe <Slope>

Sets the polarity of the active slope of an applied instrument trigger.

Parameters:

<Slope> NEGative | POSitive
 *RST: POSitive

Example:

`INP:TRIG:SLOP NEG`
 Activates the falling slope of the external trigger signal at the
 trigger input.

Manual operation: See "[Trigger Slope](#)" on page 305

12.16.8 SOURce:IQ Subsystem

The `SOURce:IQ` subsystem contains the commands for configuring the I/Q modulation.

Required options

See [Chapter 5.1, "Required Options"](#), on page 251.

<code>[:SOURce<hw>] :IQ:SOURce</code>	822
<code>[:SOURce<hw>] :IQ:STATe</code>	823
<code>[:SOURce<hw>] :IQ:GAIN</code>	823
<code>[:SOURce<hw>] :BB:IQGain</code>	823
<code>[:SOURce<hw>] :IQ:CREStfactor</code>	823
<code>[:SOURce<hw>] :IQ:SWAP[:STATe]</code>	824
<code>[:SOURce<hw>] :IQ:WBState</code>	824

[:SOURce<hw>] :IQ:SOURce <Source>

Selects the input signal source for the I/Q modulator.

Parameters:

<Source> BASeband | ANALog

External signals disable the amplitude modulation, an enabled custom digital modulation, any configured digital standard or an applied digital baseband input signal.

Example:

SOURce1:IQ:SOURce ANALog

Selects an external analog signal as the input signal. The signal must be applied at the I and Q inputs.

Manual operation: See "[Source](#)" on page 253

[:SOURce<hw>]:IQ:STATe <State>

Enables/disables the I/Q modulation.

Parameters:

<State> 0 | 1 | OFF | ON

*RST: 0

Example:

IQ:STAT ON

activates I/Q modulation.

Manual operation: See "[State](#)" on page 253

[:SOURce<hw>]:IQ:GAIN <Gain>

[:SOURce<hw>]:BB:IQGain <IqGain>

Optimizes the modulation of the I/Q modulator for a subset of measurement requirement.

Parameters:

<IqGain> DBM4 | DBM2 | DB0 | DB2 | DB4 | DB8 | DB6

Dynamic range of 16 dB divided into 2 dB steps.

DB0|DB2|DB4|DB6|DB8

Activates the specified gain of 0 dB, +2 dB, +4 dB, +6 dB, +8 dB

DBM2|DBM4

Activates the specified gain of -2 dB, -4 dB

*RST: DB4

Example:

SOURce1:BB:IQGain DB2

SOURce1:IQGain DB2

Manual operation: See "[\(Baseband\) Gain](#)" on page 255

[:SOURce<hw>]:IQ:CREStfactor <CrestFactor>

Specifies the crest factor for the external analog signal.

Parameters:

<CrestFactor> float
 Range: 0 to 35
 Increment: 0.01
 *RST: 0
 Default unit: dB

Example:

IQ:CRES 10
 specifies 10 dB crest factor for the external analog signal.

Manual operation: See "[Crest Factor](#)" on page 255

[:SOURce<hw>]:IQ:SWAP[:STATe] <State>

Swaps the I and Q channel.

Parameters:

<State> 0 | 1 | OFF | ON
 *RST: 0

Example:

IQ:SWAP ON
 swaps the I and Q channel.

Manual operation: See "[I/Q Swap](#)" on page 253

[:SOURce<hw>]:IQ:WBSTate <WbState>

Activates wideband mode.

This setting automatically optimizes the settings for wideband modulation signals (>5 MHz, State ON).

Parameters:

<WbState> 0 | 1 | OFF | ON
 *RST: 0

Example:

IQ:WBST ON
 switches to wideband mode.

Manual operation: See "[I/Q Wideband](#)" on page 254

12.16.9 SOURce:IQ:OUTPut Subsystem

The SOURce:IQ:OUTPut subsystem contains the commands for configuring the analog and digital I/Q output signals.

For information about the required options, see:

- [Chapter 8.7, "I/Q Analog Output Settings"](#), on page 435

For information on the connector and interfaces the analog and digital I/Q signals are output at, see:

Chapter 8.4.1.4, "Overview of the Input and Output Signals and Interfaces", on page 407.

12.16.9.1 SOURce:IQ:OUTPut:ANALog Commands

This section describes the commands of the output of an analog I/Q signal.

Example: Enabling and configuring the analog output

```
SCONfiguration:OUTPut:MAPPING:IQOutput1:STReam1:STATe 1
```

```
SOURce1:IQ:OUTPut:ANALog:PRESet
SOURce1:IQ:OUTPut:ANALog:TYPE DIFF
SOURce1:IQ:OUTPut:ANALog:MODE VAR
SOURce1:IQ:OUTPut:LEVel 2
SOURce1:IQ:OUTPut:ANALog:BIAS:COUPling:STATe 1
SOURce1:IQ:OUTPut:ANALog:BIAS:I 1
SOURce1:IQ:OUTPut:ANALog:BIAS:Q?
// 1
SOURce1:IQ:OUTPut:ANALog:OFFSet:I 2
SOURce1:IQ:OUTPut:ANALog:OFFSet:Q 2.5
SOURce1:IQ:OUTPut:ANALog:STATe 1
```

[SOURce<hw>]:IQ:OUTPut:ANALog:STATe.....	825
[SOURce<hw>]:IQ:OUTPut[:ANALog]:PRESet.....	826
[SOURce<hw>]:IQ:OUTPut[:ANALog]:SETTing:CATalog?.....	826
[SOURce<hw>]:IQ:OUTPut[:ANALog]:SETTing:STORE.....	826
[SOURce<hw>]:IQ:OUTPut[:ANALog]:SETTing:LOAD.....	826
[SOURce<hw>]:IQ:OUTPut[:ANALog]:SETTing:DELeTe.....	827
[SOURce<hw>]:IQ:OUTPut[:ANALog]:TYPE.....	827
[SOURce<hw>]:IQ:OUTPut[:ANALog]:MODE.....	827
[SOURce<hw>]:IQ:OUTPut:LEVel.....	827
[SOURce<hw>]:IQ:OUTPut[:ANALog]:BIAS:COUPling[:STATe].....	828
[SOURce<hw>]:IQ:OUTPut[:ANALog]:BIAS:I.....	828
[SOURce<hw>]:IQ:OUTPut[:ANALog]:BIAS:Q.....	828
[SOURce<hw>]:IQ:OUTPut[:ANALog]:OFFSet:I.....	828
[SOURce<hw>]:IQ:OUTPut[:ANALog]:OFFSet:Q.....	828
[SOURce<hw>]:IQ:OUTPut[:ANALog]:POWer:DATTenuation.....	829

[SOURce<hw>]:IQ:OUTPut:ANALog:STATe <State>

Activates the specified analog I/Q output.

Parameters:

<State> 0 | 1 | OFF | ON
*RST: 0

Example:

```
SOURce:IQ:OUTPut:ANALog:STATe ON
```

Activates the output of the analog I/Q signal on the [I/Q Out 1] connectors.

Manual operation: See "State" on page 438

[:SOURce<hw>]:IQ:OUTPut[:ANALog]:PRESet

Sets the default settings (*RST values specified for the commands).

Not affected are:

- The state set with the command `[:SOURce<hw>]:IQ:OUTPut:ANALog:STATe`.
- If `SCONfiguration:EXTernal:PBEHaviour 1`, the I/Q output type set with the command `[:SOURce<hw>]:IQ:OUTPut[:ANALog]:TYPE`.

Example: See [Example "Enabling and configuring the analog output"](#) on page 825.

Usage: Event

Manual operation: See "Set to Default" on page 438

[:SOURce<hw>]:IQ:OUTPut[:ANALog]:SETTING:CATalog?

Queries the files with I/Q output settings in the default directory. Listed are files with the file extension `*.iqout`.

Usage: Query only

Manual operation: See "Save/Recall" on page 438

[:SOURce<hw>]:IQ:OUTPut[:ANALog]:SETTING:STORe <Filename>

Stores the current settings into the selected file; the file extension (`*.iqout`) is assigned automatically.

Setting parameters:

<Filename> "<filename>"
 Filename or complete file path

Usage: Setting only

Manual operation: See "Save/Recall" on page 438

[:SOURce<hw>]:IQ:OUTPut[:ANALog]:SETTING:LOAD <Filename>

Loads the selected file from the default or the specified directory. Loaded are files with extension `*.iqout`.

Setting parameters:

<Filename> "<filename>"
 Filename or complete file path

Usage: Setting only

Manual operation: See "Save/Recall" on page 438

[:SOURce<hw>]:IQ:OUTPut[:ANALog]:SETting:DELeTe <Filename>

Deletes the selected file from the default or specified directory. Deleted are files with the file extension *.iqout.

Setting parameters:

<Filename> "<filename>"
Filename or complete file path

Usage: Setting only

Manual operation: See "[Save/Recall](#)" on page 438

[:SOURce<hw>]:IQ:OUTPut[:ANALog]:TYPE <Type>

Sets the type of the analog signal.

Parameters:

<Type> SINGLE | DIFFerential
*RST: SING (if SCONfiguration:EXTernal:PBEHaviour 0) /
 - (if SCONfiguration:EXTernal:PBEHaviour 1)

Example: SOURce1:IQ:OUTPup:ANALog:TYPE DIFFerential

Options: DIFFerential requires R&S SMBVB-K17

Manual operation: See "[I/Q Connection](#)" on page 418

[:SOURce<hw>]:IQ:OUTPut[:ANALog]:MODE <Mode>

Determines the mode for setting the output parameters.

Parameters:

<Mode> FIXed | VARiable | VATTenuated
FIXed
Locks the I/Q output settings
VARiable
Unlocks the settings
VATTenuated
Attenuates the signal with the value set with the command [:
[SOURce<hw>\]:IQ:OUTPut\[:ANALog\]:POWER:
DATTenuation.](#)
*RST: FIXed

Example: See [Example "Enabling and configuring the analog output"](#)
on page 825.

Manual operation: See "[Mode](#)" on page 439

[:SOURce<hw>]:IQ:OUTPut:LEVel <Level>

Sets the off-load voltage V_p of the analog I/Q signal output.

The value range is adjusted so that the maximum overall output voltage does not exceed 4V, see ["Maximum overall output voltage"](#) on page 437.

Parameters:

<Level> float
 Range: 0.02V to 4V
 Increment: 1E-4
 *RST: 1
 Default unit: V

Example: See [Example "Enabling and configuring the analog output"](#) on page 825.

Manual operation: See ["I/Q Level Vp EMF"](#) on page 440

[[:SOURce<hw>]:IQ:OUTPut[:ANALog]:BIAS:COUPling[:STATe] <State>

Couples the bias setting of the I and Q signal components.

Parameters:

<State> 0 | 1 | OFF | ON
 *RST: 0

Example: See [Example "Enabling and configuring the analog output"](#) on page 825.

Manual operation: See ["Couple I/Q Bias"](#) on page 440

[[:SOURce<hw>]:IQ:OUTPut[:ANALog]:BIAS:I <I>
[[:SOURce<hw>]:IQ:OUTPut[:ANALog]:BIAS:Q <Q>

Specifies the amplifier bias V_{bias} of the respective I or Q component.

The value range is adjusted so that the maximum overall output voltage does not exceed 4V, see ["Maximum overall output voltage"](#) on page 437.

Parameters:

<Q> float
 Range: -3.6V to 3.6V
 Increment: 1E-4
 *RST: 0
 Default unit: V

Example: See [Example "Enabling and configuring the analog output"](#) on page 825.

Manual operation: See ["Bias \(EMF\)"](#) on page 440

[[:SOURce<hw>]:IQ:OUTPut[:ANALog]:OFFSet:I <I>
[[:SOURce<hw>]:IQ:OUTPut[:ANALog]:OFFSet:Q <Q>

Sets an offset V_{offset} between the inverting and non-inverting input of the differential analog I/Q output signal.

The value range is adjusted so that the maximum overall output voltage does not exceed 4V, see ["Maximum overall output voltage"](#) on page 437.

Parameters:

<Q> float
 Range: -0.3V to 0.3V
 Increment: 1E-4
 *RST: 0
 Default unit: V

Example: See [Example "Enabling and configuring the analog output"](#) on page 825.

Manual operation: See ["Offset \(EMF\)"](#) on page 441

[:SOURce<hw>]:IQ:OUTPut[:ANALog]:POWer:DATTenuation <DAttenuation>

For [:SOURce<hw>] : IQ : OUTPut [:ANALog] : MODEVATTenuated, set the attenuation with that the signal is attenuated.

Parameters:

<DAttenuation> float
 Range: -3.522 to 80
 Increment: 1E-3
 *RST: 0

Example: SOURce1:IQ:OUTPut:ANALog:MODE VATTenuated
 SOURce1:IQ:OUTPut:ANALog:POWer:DATTenuation 10

Manual operation: See ["Digital Attenuation"](#) on page 440

12.16.10 SOURce:LFOutput Subsystem

The SOURce:LFOutput subsystem contains the commands for setting the LF signal source in CW and Sweep mode and for analog modulation.

Example: Setup an LF sweep

The following example shows a command sequence to set up an LF sweep.

```
// Reset the instrument to start from an initial state
*RST; *CLS

// Set the trigger mode, the sweep mode and the sweep range
TRIGger1:LFFSweep:SOURce SINGLE
SOURce1:LFOutput1:SWEep:FREQuency:MODE AUTO
SOURce1:LFOutput1:FREQuency:START 1 kHz
SOURce1:LFOutput1:FREQuency:STOP 7 kHz

// Select linear spacing
// Select the waveform shape for the frequency sweep cycle
// Set the step width and the dwell time.
```

```

SOURcel:LFOutput1:SWEep:FREQuency:SPACing LINear
SOURcel:LFOutput1:SWEep:FREQuency:SHApe SAWtooth
SOURcel:LFOutput1:SWEep:FREQuency:STEP:LINear 100 Hz
SOURcel:LFOutput1:SWEep:FREQuency:DWELl 150 ms
// Alternatively to the step width set the number of steps
SOURcel:LFOutput1:SWEep:FREQuency:POINts 61

// Activate change to start frequency while waiting for next trigger
// Prerequisites: sweep mode single and sweep waveform sawtooth
SOURcel:LFOutput:SWEep:FREQuency:RETRace 1

// Activate the LF frequency sweep
SOURcel:LFOutput:FREQuency:MODE SWE

// Trigger the sweep (depending on the set mode) and query the status
// Perform a one-off LF sweep
SOURcel:LFOutput1:SWEep:FREQuency:EXECute
SOURcel:LFOutput1:SWEep:FREQuency:RUNning?
// 1
// the sweep is running

// *****
// For manual step LF sweep use the following commands
*RST; *CLS
SOURcel:LFOutput:SWEep:FREQuency:MODE MANual
// Activate the LF frequency sweep
SOURcel:LFOutput:FREQuency:MODE SWEep
// Activate LF Output1.
SOURcel:LFOutput1:STATE 1
// Input the frequency manually for each step
SOURcel:LFOutput1:FREQuency:MANual 2 kHz
SOURcel:LFOutput1:FREQuency:MANual 2.1 kHz
// Alternatively use UP or DOWN parameter with set step width.
SOURcel:LFOutput1:SWEep:FREQuency:STEP:LINear 500 Hz
SOURcel:LFOutput1:FREQuency:MANual UP

```

Example: Configuring the LF generator

The following is a simple example on how to configure the LF generator and output the generated signal.

```

// configure the signal of the LF1 generator
SOURcel:LFOutput1:SHApe SQU
SOURcel:LFOutput1:SHApe:PULSe:PERiod 0.001
SOURcel:LFOutput1:SHApe:PULSe:WIDTh 0.0005
SOURcel:LFOutput1:SHApe:PULSe:DCYCLE 0.5
// configure the signal of the LF1 generator
SOURcel:LFOutput2:SHApe SINE
SOURcel:LFOutput2:FREQuency 1000000
SOURcel:LFOutput2:PERiod?
// 0.000001

```

```
// changing the LF signal shape
// SOURce1:LFOutput2:SHAPE TRAP
// SOURce1:LFOutput2:SHAPE:PULSE:PERIOD 0.2
// SOURce1:LFOutput2:SHAPE:TRAPeZE:RISE 0.0001
// SOURce1:LFOutput2:SHAPE:TRAPeZE:FALL 0.001
// SOURce1:LFOutput2:SHAPE:TRAPeZE:FALL 0.0001
// SOURce1:LFOutput2:SHAPE:TRAPeZE:HIGh 0.0005
// SOURce1:LFOutput2:SHAPE TRI
// SOURce1:LFOutput2:SHAPE:PULSE:PERIOD 0.1
// SOURce1:LFOutput2:SHAPE:TRIangle:RISE 0.0001

// activate the LF output and select the LF1 as signal source
// configure the LF output signal
SOURce1:LFOutput1:FREQuency:MODE CW
SOURce1:LFOutput1:STATe 1
SOURce1:LFOutput1:SOURce LF1
SOURce1:LFOutput1:INTernal:VOLTagE 1
SOURce1:LFOutput1:OFFSet 0.001
```

- [LF Generator Settings](#).....831
- [LF Sweep Settings](#).....839

12.16.10.1 LF Generator Settings

With the commands described in this section, you can configure the LF signal source.

[:SOURce]:LFOutput<ch>:BANDwidth?	832
[:SOURce]:LFOutput<ch>:FREQuency	832
[:SOURce<hw>]:LFOutput<ch>:PERIOD?	832
[:SOURce<hw>]:LFOutput:FREQuency:MANual	833
[:SOURce<hw>]:LFOutput:FREQuency:MODE	833
[:SOURce<hw>]:LFOutput:FREQuency:STOP	834
[:SOURce<hw>]:LFOutput:FREQuency:START	834
[:SOURce]:LFOutput<ch>[:STATe]	834
[:SOURce]:LFOutput<ch>:INTernal:VOLTagE	834
[:SOURce]:LFOutput:OFFSet	835
[:SOURce]:LFOutput<ch>:SOURce	835
[:SOURce]:LFOutput:SIMPedance	835
[:SOURce]:LFOutput<ch>:SOURce:PATH	836
[:SOURce]:LFOutput:VOLTagE	836
[:SOURce<hw>]:LFOutput<ch>:SHAPE	836
[:SOURce<hw>]:LFOutput<ch>:SHAPE:PULSE:DCYCLE	836
[:SOURce<hw>]:LFOutput<ch>:SHAPE:PULSE:PERIOD	837
[:SOURce<hw>]:LFOutput<ch>:SHAPE:PULSE:WIDTH	837
[:SOURce<hw>]:LFOutput<ch>:SHAPE:TRAPeZE:FALL	837
[:SOURce<hw>]:LFOutput<ch>:SHAPE:TRAPeZE:HIGh	837
[:SOURce<hw>]:LFOutput<ch>:SHAPE:TRAPeZE:PERIOD	838

<code>[:SOURce<hw>]:LFOOutput<ch>:SHAPE:TRAPeZe:RISE</code>	838
<code>[:SOURce<hw>]:LFOOutput<ch>:SHAPE:TRlAngle:PERiod</code>	838
<code>[:SOURce<hw>]:LFOOutput<ch>:SHAPE:TRlAngle:RISE</code>	838

`[:SOURce]:LFOOutput<ch>:BANDwidth?`

Queries the bandwidth of the external LF signal.

Return values:

<Bandwidth> BW0M2 | BW10m
 *RST: BW10m

Example:

```
LFO:BAND?
// BW10m
// the bandwidth of the externally supplied LF signal is 10 MHz
```

Usage: Query only

Manual operation: See "[Bandwidth](#)" on page 340

`[:SOURce]:LFOOutput<ch>:FREQuency <Frequency>`

Sets the frequency of the LF signal in `[:SOURce<hw>]:LFOOutput:FREQuency:MODE` CW | FIXed mode.

Note

- If signal source "Internal" is set, the instrument performs the analog modulations (AM/FM/PhiM/PM) with this frequency.
- In sweep mode (`[:SOURce<hw>]:LFOOutput:FREQuency:MODE` SWE), the frequency is coupled with the sweep frequency.

Parameters:

<Frequency> float
 Range: depends on the installed options
 *RST: 1000
 Default unit: Hz

Example:

```
SOURce1:LFOOutput1:FREQuency 5 kHz
// sets the LF frequency
```

Manual operation: See "[Frequency](#)" on page 338

`[:SOURce<hw>]:LFOOutput<ch>:PERiod?`

Queries the repetition frequency of the sine signal.

Return values:

<LfSinePeriod> float
 Range: 1E-6 to 100
 Increment: 10E-9
 *RST: 0.001
 Default unit: s

Example: See [Example "Configuring the LF generator"](#) on page 830.

Usage: Query only

[:SOURce<hw>] :LFOutput:FREQuency:MANual <Manual>

Sets the frequency of the subsequent sweep step if `LFO :SWE :MODE MAN`.

Use a separate command for each sweep step.

Parameters:

<Manual> float

You can select any value within the setting range, where:

START is set with `[:SOURce<hw>] :LFOutput:FREQuency:START`

STOP is set with `[:SOURce<hw>] :LFOutput:FREQuency:STOP`

Range: START to STOP

Increment: 0.1

*RST: 1000

Example: See [Example "Setup an LF sweep"](#) on page 829.

Manual operation: See ["Current Frequency"](#) on page 302

[:SOURce<hw>] :LFOutput:FREQuency:MODE <Mode>

Sets the mode for the output of the LF generator frequency, and determines the commands to be used for frequency settings.

Parameters:

<Mode> CW | FIXed | SWEep

CW|FIXed

Sets the fixed-frequency mode. CW and FIXed are synonyms.

To set the output frequency, use command `[:SOURce] :LFOutput<ch>:FREQuency`

SWEep

Sets sweep mode.

To set the frequency, use the commands:

`[:SOURce<hw>] :LFOutput:FREQuency:START` and `[:SOURce<hw>] :LFOutput:FREQuency:STOP`

Or `[:SOURce<hw>] :LFOutput:FREQuency:MANual`

*RST: CW

Example: See [Example "Setup an LF sweep"](#) on page 829.

Manual operation: See ["State \(LF frequency sweep\)"](#) on page 301

[[:SOURce<hw>]:LFOutput:FREQUENCY:STOP <Stop>

[[:SOURce<hw>]:LFOutput:FREQUENCY:START <Start>

Sets the start/stop frequency for [[:SOURce<hw>]:LFOutput:FREQUENCY:MODE
SWEep.

Parameters:

<Start> float
Range: 0.1 Hz to 1 MHz
Increment: 0.1
*RST: 1 KHz

<Stop> float
Range: 0.1 Hz to 1 MHz
Increment: 0.1 Hz
*RST: 100 KHz

Example: See [Example "Setup an LF sweep"](#) on page 829.

Manual operation: See [" Start Frequency/Stop Frequency "](#) on page 306

[[:SOURce]:LFOutput<ch>[:STATe] <State>

Activates LF signal output.

Parameters:

<State> 0 | 1 | OFF | ON
*RST: 0

Example: See [Example "Configuring the LF generator"](#) on page 830.

Manual operation: See ["State"](#) on page 342

[[:SOURce]:LFOutput<ch>:INTERNAL:VOLTage <Voltage>

Sets the output voltage for the LF generators.

The sum of both values must not exceed the overall output voltage, set with command
[\[:SOURce\]:LFOutput:VOLTage](#).

Suffix:

<ch> [1]2
LF1 and LF2

Parameters:

<Voltage> float
Range: 0 to 4
Increment: 0.001
*RST: 1

Example: See [Example "Configuring the LF generator"](#) on page 830.

Manual operation: See ["Output Voltage"](#) on page 342

[[:SOURce]:LFOutput:OFFSet <Offset>

Sets a DC offset at the LF Output.

Parameters:

<Offset> float
 Range: depends on lfo voltage
 Increment: 0.001
 *RST: 0

Example: See [Example "Configuring the LF generator"](#) on page 830.

Manual operation: See ["DC-Offset"](#) on page 342

[[:SOURce]:LFOutput<ch>:SOURce <Source>

Determines the LF signal to be synchronized, when monitoring is enabled.

Parameters:

<Source> LF1 | LF2 | NOISe | AM | FMPM | EXT1
LF1|LF2
 Selects an internally generated LF signal.
NOISe
 Selects an internally generated noise signal.
EXT1
 Selects an externally supplied LF signal
AM
 Selects the AM signal.
FMPM
 Selects the signal also used by the frequency or phase modulations.
 *RST: LF1

Example: See [Example "Configuring the LF generator"](#) on page 830.

Manual operation: See ["Source"](#) on page 342

[[:SOURce]:LFOutput:SIMPedance <SImpedance>

Selects the impedance of the LF output.

Parameters:

<SImpedance> G600 | G50
 *RST: G50

Example:

```
SOURce:LFOutput:SIMPedance G600
// Sets the output impedance of the LF generator to 600 Ohm
```

Manual operation: See ["Source Impedance"](#) on page 342

[[:SOURce]:LFOutput<ch>:SOURce:PATH <SourPath>

Determines the path of the LF output source.

Parameters:

<SourPath> A | B
*RST: A

Example:

LFO:SOUR:PATH?
Queries the currently set path for the LF output signal source.

[[:SOURce]:LFOutput:VOLTage <Voltage>

Sets the voltage of the LF output.

Parameters:

<Voltage> float
Range: dynamic (see data sheet)
Increment: 0.001
*RST: 1

Example:

SOURce:LFOutput:VOLTage 1.5

[[:SOURce<hw>]:LFOutput<ch>:SHAPE <Shape>

Selects the waveform shape of the LF signal.

Parameters:

<Shape> SINE | SQUARE | TRIangle | TRAPeze
*RST: SINE

Example:

See [Example "Configuring the LF generator"](#) on page 830.

Options:

TRIangle|TRAPeze require R&S SMBVB-K24

Manual operation:

See ["Shape"](#) on page 337

[[:SOURce<hw>]:LFOutput<ch>:SHAPE:PULSE:DCYCLE <DCycle>

Sets the duty cycle for the shape pulse.

Parameters:

<DCycle> float
Range: 1E-6 to 100
Increment: 1E-6
*RST: 50
Default unit: PCT

Example:

See [Example "Configuring the LF generator"](#) on page 830.

Manual operation:

See ["Pulse Duty Cycle"](#) on page 338

[[:SOURce<hw>]:LFOutput<ch>:SHAPE:PULSE:PERiod <Period>

Sets the period of the generated pulse. The period determines the repetition frequency of the internal signal.

Parameters:

<Period> float
Range: 1E-6 to 100
Increment: 1E-8
*RST: 1E-3

Example: See [Example "Configuring the LF generator"](#) on page 830.

Manual operation: See ["Period"](#) on page 338

[[:SOURce<hw>]:LFOutput<ch>:SHAPE:PULSE:WIDTH <Width>

Sets the pulse width of the generated pulse.

Parameters:

<Width> float
Range: 1E-6 to 100
Increment: 1E-8
*RST: 5E-4

Example: See [Example "Configuring the LF generator"](#) on page 830.

Manual operation: See ["Pulse Width"](#) on page 338

[[:SOURce<hw>]:LFOutput<ch>:SHAPE:TRAPEze:FALL <Fall>

Selects the fall time for the trapezoid shape of the LF generator.

Parameters:

<Fall> float
Range: 1E-6 to 100
Increment: 10E-9
*RST: 250E-6

Example: See [Example "Configuring the LF generator"](#) on page 830.

Manual operation: See ["Trapezoid Rise / Fall"](#) on page 339

[[:SOURce<hw>]:LFOutput<ch>:SHAPE:TRAPEze:HIGh <High>

Sets the high time for the trapezoid signal of the LF generator.

Parameters:

<High> float
Range: 1E-6 to 100
Increment: 10E-9
*RST: 250E-6

Example: See [Example "Configuring the LF generator"](#) on page 830.

Manual operation: See ["Trapezoid High"](#) on page 339

[:SOURce<hw>]:LFOutput<ch>:SHAPE:TRAPeZe:PERiod <Period>

Sets the period of the generated trapezoid shape. The period determines the repetition frequency of the internal signal.

Parameters:

<Period>	float
Range:	1E-6 to 100
Increment:	1E-8
*RST:	1E-3

Example: See [Example "Configuring the LF generator"](#) on page 830.

Manual operation: See ["Period"](#) on page 338

[:SOURce<hw>]:LFOutput<ch>:SHAPE:TRAPeZe:RISE <Rise>

Selects the rise time for the trapezoid shape of the LF generator.

Parameters:

<Rise>	float
Range:	1E-6 to 100
Increment:	10E-9
*RST:	250E-6

Example: See [Example "Configuring the LF generator"](#) on page 830.

Manual operation: See ["Trapezoid Rise / Fall"](#) on page 339

[:SOURce<hw>]:LFOutput<ch>:SHAPE:TRlangle:PERiod <Period>

Sets the period of the generated pulse. The period determines the repetition frequency of the internal signal.

Parameters:

<Period>	float
Range:	1E-6 to 100
Increment:	10E-9
*RST:	0.001

Example: See [Example "Configuring the LF generator"](#) on page 830.

Manual operation: See ["Period"](#) on page 338

[:SOURce<hw>]:LFOutput<ch>:SHAPE:TRlangle:RISE <Rise>

Selects the rise time for the triangle single of the LF generator.

Parameters:

<Rise> float
 Range: 1E-6 to 100
 Increment: 10E-9
 *RST: 0.5E-3

Example: See [Example "Configuring the LF generator"](#) on page 830.

Manual operation: See ["Triangle Rise"](#) on page 338

12.16.10.2 LF Sweep Settings

With the commands described in this section, you can configure the sweep of the LF signal.

[:SOURce<hw>]:LFOutput:SWEep[:FREQUENCY]:DWELI	839
[:SOURce<hw>]:LFOutput:SWEep[:FREQUENCY]:EXECute	839
[:SOURce<hw>]:LFOutput:SWEep[:FREQUENCY]:MODE	840
[:SOURce<hw>]:LFOutput:SWEep[:FREQUENCY]:POINts	840
[:SOURce<hw>]:LFOutput:SWEep[:FREQUENCY]:RETRace	840
[:SOURce<hw>]:LFOutput:SWEep[:FREQUENCY]:RUNNING?	841
[:SOURce<hw>]:LFOutput:SWEep[:FREQUENCY]:SHAPE	841
[:SOURce<hw>]:LFOutput:SWEep[:FREQUENCY]:SPACing	841
[:SOURce<hw>]:LFOutput:SWEep[:FREQUENCY]:STEP:LOGarithmic	841
[:SOURce<hw>]:LFOutput:SWEep[:FREQUENCY]:STEP[LINear]	842

[:SOURce<hw>]:LFOutput:SWEep[:FREQUENCY]:DWELI <Dwell>

Sets the dwell time for each frequency step of the sweep.

Parameters:

<Dwell> float
 Range: 0.005 to 100
 Increment: 100E-6
 *RST: 0.01
 Default unit: s

Example: See [Example "Setup an LF sweep"](#) on page 829.

Manual operation: See [" Dwell Time "](#) on page 304

[:SOURce<hw>]:LFOutput:SWEep[:FREQUENCY]:EXECute

Immediately starts an LF sweep.

[\[:SOURce<hw>\]:LFOutput:SWEep\[:FREQUENCY\]:MODE](#) determines which sweep is executed, e.g. `SOURce:LFOutput:SWEep:FREQUENCY:MODE STEP`.

Example: See [Example "Setup an LF sweep"](#) on page 829.

Usage: Event

Manual operation: See [" Execute Single Sweep "](#) on page 305

[:SOURce<hw>] :LFOutput:SWEep[:FREQuency]:MODE <Mode>

Sets the cycle mode of the LF sweep.

Parameters:

<Mode>

AUTO | MANual | STEP

AUTO

Performs a complete sweep cycle from the start to the end value when a trigger event occurs.

The dwell time determines the time period until the signal switches to the next step.

MANual

Performs a single sweep step when a manual trigger event occurs.

The trigger system is not active. To trigger each frequency step of the sweep individually, use the command `[:SOURce<hw>] :LFOutput:FREQuency:MANual` on page 833.

STEP

Each trigger command triggers one sweep step only.

The frequency increases by the value set with the coammnds:

`[:SOURce<hw>] :LFOutput:SWEep[:FREQuency]:STEP[:LINear]` (linear spacing)

`[:SOURce<hw>] :LFOutput:SWEep[:FREQuency]:STEP:LOGarithmic` (logarithmic spacing)

*RST: AUTO

Example: See [Example "Setup an LF sweep"](#) on page 829.

Manual operation: See ["Mode"](#) on page 302

[:SOURce<hw>] :LFOutput:SWEep[:FREQuency]:POINts <Points>

Sets the number of steps in an LF sweep.

For information on how the value is calculated and the interdependency with other parameters, see [Chapter 6.10.2.1, "Correlating Parameters in Sweep Mode"](#), on page 294

Parameters:

<Points>

integer

Range: 2 to POINts

*RST: 50

Example: See [Example "Setup an LF sweep"](#) on page 829.

[:SOURce<hw>] :LFOutput:SWEep[:FREQuency]:RETRace <State>

Activates that the signal changes to the start frequency value while it is waiting for the next trigger event.

You can enable this feature, when you are working with sawtooth shapes in sweep mode "Single" or "External Single".

Parameters:

<State> 0 | 1 | OFF | ON
 *RST: 0

Manual operation: See ["Retrace"](#) on page 303

[[:SOURce<hw>]:LFOutput:SWEep[:FREQUENCY]:RUNNING?

Queries the current status of the LF frequency sweep mode.

Return values:

<State> 0 | 1 | OFF | ON

Example: See [Example "Setup an LF sweep"](#) on page 829.

Usage: Query only

[[:SOURce<hw>]:LFOutput:SWEep[:FREQUENCY]:SHAPE <Shape>

Sets the cycle mode for a sweep sequence (shape).

Parameters:

<Shape> SAWTooth | TRIangle
 *RST: SAWTooth

Example: See [Example "Setup an LF sweep"](#) on page 829.

Manual operation: See [" Shape"](#) on page 303

[[:SOURce<hw>]:LFOutput:SWEep[:FREQUENCY]:SPACING <Spacing>

Selects linear or logarithmic sweep spacing.

Parameters:

<Spacing> LINear | LOGarithmic
 *RST: LINear

Example: See [Example "Setup an LF sweep"](#) on page 829.

Manual operation: See [" Spacing"](#) on page 304

**[[:SOURce<hw>]:LFOutput:SWEep[:FREQUENCY]:STEP:LOGarithmic
 <Logarithmic>**

Sets the step width factor for logarithmic sweeps to calculate the frequencies of the steps.

For information on how the value is calculated and the interdependency with other parameters, see [Chapter 6.10.2.1, "Correlating Parameters in Sweep Mode"](#), on page 294

Parameters:

<Logarithmic> float
 The unit is mandatory
 Range: 0.01 to 100
 Increment: 0.01
 *RST: 1
 Default unit: PCT

Example: See [Example "Setup an LF sweep"](#) on page 829.

Manual operation: See "[Step Linear/Step Logarithmic](#)" on page 307

[:SOURce<hw>]:LFOutput:SWEep[:FREQUENCY]:STEP[:LINEar] <Linear>

Sets the step width for the linear sweep.

For information on how the value is calculated and the interdependency with other parameters, see [Chapter 6.10.2.1, "Correlating Parameters in Sweep Mode"](#), on page 294

Parameters:

<Linear> float
 Range: 0.1 to STOP-START
 Increment: 0.1
 *RST: 1000

Example: See [Example "Setup an LF sweep"](#) on page 829.

Manual operation: See "[Step Linear/Step Logarithmic](#)" on page 307

12.16.11 SOURce:LIST Subsystem

The SOURce:LIST subsystem contains all commands for defining lists and for handling of list files.

List files have the predefined file extension *.lsw.

Refer to [Chapter 12.6.2, "Accessing Files in the Default or in a Specified Directory"](#), on page 588 for general information on file handling in the default and in a specific directory.



- *RST does not affect data lists.
- SCPI refers to the individual lists as segments.

Example: Create an RF list and activate the list mode

The following example shows a command sequence to create an RF list and to activate the list mode. Further hardware settings are not considered.

```
// Reset the instrument to start from an initial state
// Query the available list files in the default
```

```

// directory /var/user
// Select the list file or create it (if not existing)
*RST; *CLS
SOUR1:LIST:CAT?
// Response:- shows the name of available list files (if applicable)
SOUR1:LIST:SEL "/var/user/list1.lsw"

// Write the frequency/level/dwell time values in the selected list file
// existing data is overwritten
// Query the number of frequency/power/dwell time entries in the selected list
// Query the amount of free memory (in bytes) for list mode lists
SOUR1:LIST:FREQ 58 MHz, 61 MHz, 73 MHz, 86 MHz, 91 MHz, 92 MHz, 98 MHz
SOUR1:LIST:POW 13 dBm, 12 dBm, 5 dBm, 3 dBm, 0 dBm, 4 dBm, 6 dBm
SOUR1:LIST:DWEL:LIST 10000, 100000, 200000, 19000, 10000, 150000, 220000
SOUR1:LIST:FREQ:POIN?
// 7
SOUR1:LIST:POW:POINT?
// 7
SOUR1:LIST:DWEL:LIST:POIN?
// 7
SOUR1:LIST:FREE?
// 2147483647 (bytes of free memory)

// Use dwell times from list
// Configure the list mode parameters
// Enable RF output
SOUR1:LIST:MODE AUTO
SOUR1:LIST:TRIG:SOUR AUTO
SOUR1:LIST:DWEL:MODE "LIST"

OUTP1:STAT ON

// Use global dwell time
// Set only a part of the list (value pairs 3 to 5) to be processed
// Configure the list mode parameters using global dwell time
// Enable RF output
SOUR1:LIST:IND:START 2
SOUR1:LIST:IND:STOP 4
SOUR1:LIST:MODE AUTO
SOUR1:LIST:TRIG:SOUR AUTO
SOUR1:LIST:DWEL:LIST 500 ms
OUTP1:STAT ON

// Enable the list mode
// Trigger the list (depending on the mode, not needed with trigger
// mode AUTO); query the current index
// Reset the list to the starting point
SOUR1:FREQ:MODE LIST
SOUR1:LIST:TRIG:EXEC
SOUR1:LIST:RUNN?
SOUR1:LIST:IND?

```

```

// 3
// value changes when the value is queried again
SOUR1:LIST:RES

// For list mode STEP use the following commands
*RST; *CLS
// Change list mode to STEP
SOUR1:LIST:MODE STEP
// Activate RF Output1
OUTP1:STAT 1
// Activate the list mode
SOUR1:FREQ:MODE LIST
// For each step: select frequency/powerlevel pair as index from the list
SOUR1:LIST:IND 2
SOUR1:LIST:IND 3
SOUR1:LIST:IND 4

// Use the selected list for path B (with List Mode B default settings)
SOUR2:LIST:SEL "/var/user/list1.lsw"
OUTP2:STAT ON
SOUR2:FREQ:MODE LIST
SOUR2:LIST:IND?
// 2
// value changes when the value is queried again

// Deactivate the list mode
SOUR1:FREQ:MODE CW

```

Example: List mode data exchange

The following example shows a command sequence to export a list (here the RF list created with the example before) into an ASCII file. Further hardware settings are not considered.

```

*RST; *CLS
LIST:DEXC:MODE EXP

// Set ASCII data parameters
// Set the ASCII file extension, the decimal separator
// and the column separator for the ASCII data
SOUR1:LIST:DEXC:AFIL:EXT CSV
SOUR1:LIST:DEXC:AFIL:SEP:DEC DOT
SOUR1:LIST:DEXC:AFIL:SEP:COL COMM

// Select source and destination path/directory
// Query available listfiles in default directory "/var/user"
SOUR1:LIST:CAT?
// list1
SOUR1:LIST:DEXC:AFIL:SEL "/var/user/list1ASCII"
SOUR1:LIST:DEXC:SEL "/var/user/list1"

```

```
// Export the list file data into the ASCII file
SOUR1:LIST:DEXC:EXEC

// Query the available ASCII files with extension .csv
SOUR1:LIST:DEXC:AFIL:CAT?
// Response: "list1ASCII"

// Deactivate the list mode
SOUR1:FREQ:MODE CW
```

- [List Mode Settings](#).....845
- [List Mode File Operation](#).....851
- [List Mode Data Exchange](#).....853

12.16.11.1 List Mode Settings

With the following commands, you can create list mode data, select the trigger mode and determine the dwell time.

[:SOURce<hw>]:LIST:DWELI	845
[:SOURce<hw>]:LIST:DWELI:MODE	846
[:SOURce<hw>]:LIST:DWELI:LIST	846
[:SOURce<hw>]:LIST:DWELI:LIST:POINts?	846
[:SOURce<hw>]:LIST:FREQuency	847
[:SOURce<hw>]:LIST:FREQuency:POINts?	847
[:SOURce<hw>]:LIST:INDEx	847
[:SOURce<hw>]:LIST:INDEx:STARt	848
[:SOURce<hw>]:LIST:INDEx:STOP	848
[:SOURce<hw>]:LIST:MODE	848
[:SOURce<hw>]:LIST:POWEr	848
[:SOURce<hw>]:LIST:POWEr:POINts?	849
[:SOURce<hw>]:LIST:RMODE	849
[:SOURce<hw>]:LIST:TRIGger:EXECute	849
[:SOURce<hw>]:LIST:TRIGger:SOURce	850
[:SOURce<hw>]:LIST:RUNNing?	850

[[:SOURce<hw>]:LIST:DWELI <Dwell>

Sets the global dwell time. The instrument generates the signal with the frequency / power value pairs of each list entry for that particular period.

See also [Significant Parameters and Functions](#).

Parameters:

<Dwell>	float
	Range: 1E-3 to 100
	Increment: 1E-6
	*RST: 0.01

Example: See [Example "Create an RF list and activate the list mode"](#) on page 842.

Manual operation: See ["Global Dwell Time"](#) on page 310

[:SOURce<hw>]:LIST:DWELI:MODE <DwellMode>

Selects the dwell time mode.

Parameters:

<DwellMode>

LIST | GLOBal

LIST

Uses the dwell time, specified in the data table for each value pair individually.

GLOBal

Uses a constant dwell time, set with command [:
[SOURce<hw>\]:LIST:DWELI.](#)

*RST: GLOBal

Example: See [Example "Create an RF list and activate the list mode"](#) on page 842.

Manual operation: See ["Dwell Time Mode"](#) on page 310

[:SOURce<hw>]:LIST:DWELI:LIST <Dwell>

Enters the dwell time values in the selected list in μ s.

Parameters:

<Dwell>

<Dwell#1>{, <Dwell#2>, ...} | block data

You can either enter the data as a list of numbers, or as binary block data. The list of numbers can be of any length, with the list entries separated by commas.

In binary block format, 8 (4) bytes are always interpreted as a floating-point number with double accuracy. See also :
[FORMat \[:DATA\]](#) on page 611 for more details.

Example: See [Example "Create an RF list and activate the list mode"](#) on page 842.

Manual operation: See ["Edit List Mode Data"](#) on page 315

[:SOURce<hw>]:LIST:DWELI:LIST:POINTs?

Queries the number (points) of dwell time entries in the selected list.

Return values:

<Points>

integer

Range: 0 to INT_MAX

*RST: 0

Example: See [Example "Create an RF list and activate the list mode"](#) on page 842.

Usage: Query only

[[:SOURce<hw>]:LIST:FREQuency <Frequency>

Enters the frequency values in the selected list.

Parameters:

<Frequency>

<Frequency#1>{, <Frequency#2>, ...} | block data

You can either enter the data as a list of numbers, or as binary block data.

The list of numbers can be of any length, with the list entries separated by commas.

In binary block format, 8 (4) bytes are always interpreted as a floating-point number with double accuracy.

See also :FORMat [:DATA].

Range: 300 kHz to RFmax (depends on the installed options)

Example: See [Example "Create an RF list and activate the list mode"](#) on page 842.

Manual operation: See ["Edit List Mode Data"](#) on page 315

[[:SOURce<hw>]:LIST:FREQuency:POINts?

Queries the number (points) of frequency entries in the selected list.

Return values:

<Points>

integer

Range: 0 to INT_MAX

*RST: 0

Example: See [Example "Create an RF list and activate the list mode"](#) on page 842.

Usage: Query only

[[:SOURce<hw>]:LIST:INDex <Index>

Sets the list index in [LIST:MODE STEP](#).

After the trigger signal, the instrument processes the frequency and level settings of the selected index.

Parameters:

<Index>

integer

*RST: 0

Example: See [Example "Create an RF list and activate the list mode"](#) on page 842.

Manual operation: See ["Current Index"](#) on page 309

[[:SOURce<hw>]:LIST:INDEX:START <Start>

[[:SOURce<hw>]:LIST:INDEX:STOP <Stop>

Sets the start and stop index of the index range which defines a subgroup of frequency/level value pairs in the current list.

Parameters:

<Start>/<Stop> integer
 Index range
 Only values inside this range are processed in list mode
 Range: 0 to list length
 *RST: 0

Example: See [Example "Create an RF list and activate the list mode"](#) on page 842.

Manual operation: See "[List Range from/to](#)" on page 312

[[:SOURce<hw>]:LIST:MODE <Mode>

Sets the list mode.

The instrument processes the list according to the selected mode and trigger source, see [LIST:TRIG:SOUR AUTO](#), [SING](#) or [EXT](#).

Parameters:

<Mode> AUTO | STEP
AUTO
 Each trigger event triggers a complete list cycle.
STEP
 Each trigger event triggers only one step in the list processing cycle. The list is processed in ascending order.
 In this mode, you can select between [LIST:TRIG:SOUR SING](#) or [EXT](#).
 *RST: AUTO

Example: See [Example "Create an RF list and activate the list mode"](#) on page 842.

Manual operation: See "[Mode](#)" on page 309

[[:SOURce<hw>]:LIST:POWER <Power>

Enters the level values in the selected list. The number of level values must correspond to the number of frequency values. Existing data is overwritten.

Parameters:

<Power> <Power#1>{, <Power#2>, ...} | block data
 You can either enter the data as a list of numbers, or as binary block data.
 The list of numbers can be of any length, with the list entries separated by commas.
 In binary block format, 8 (4) bytes are always interpreted as a floating-point number with double accuracy.
 See also :FORMat [:DATA].
 Range: depends on the installed options
 Default unit: dBm

Example: See [Example "Create an RF list and activate the list mode"](#) on page 842.

Manual operation: See ["Edit List Mode Data"](#) on page 315

[:SOURce<hw>]:LIST:POWer:POINts?

Queries the number (points) of level entries in the selected list.

Return values:

<Points> integer
 Range: 0 to INT_MAX
 *RST: 0

Example: See [Example "Create an RF list and activate the list mode"](#) on page 842.

Usage: Query only

[:SOURce<hw>]:LIST:RMODe <RMode>

Selects the run mode for processing the list.

Parameters:

<RMode> LIVE
LIVE
 Generates the signal by processing the list directly.
 *RST: LIVE

Example: See [Example "Create an RF list and activate the list mode"](#) on page 842.

[:SOURce<hw>]:LIST:TRIGger:EXECute

Starts the processing of a list in list mode.

Example: See [Example "Create an RF list and activate the list mode"](#) on page 842.

Usage: Event

Manual operation: See "[Execute Single](#)" on page 311

[:SOURce<hw>]:LIST:TRIGger:SOURce <Source>

Selects the trigger source for processing lists.

The names of the parameters correspond to those in sweep mode. SCPI standard uses other names for the parameters; these names are also accepted by the instrument. The SCPI names should be used if compatibility is an important consideration. For an overview, see the following table:

Rohde & Schwarz name	SCPI name	Command in manual control
AUTO	IMMediate	MODE AUTO
SINGle	BUS	MODE SINGLE or STEP
EXTeRnal	EXTeRnal	MODE EXT TRIG SINGLE or EXT TRIG STEP

Parameters:

<Source>

SINGle | BUS | AUTO | EXTeRnal | IMMediate

AUTO|IMMediate

The trigger is free-running, i.e. the trigger condition is fulfilled continuously. The selected list is restarted as soon as it is finished.

SINGle|BUS

The list is triggered by the command `[:SOURce<hw>] :LIST:TRIGger:EXECute`. The list is executed once.

EXTeRnal

The list is triggered externally and executed once.

*RST: AUTO

Example:

See [Example "Create an RF list and activate the list mode"](#) on page 842.

Manual operation: See "[Mode](#)" on page 309

[:SOURce<hw>]:LIST:RUNNing?

Queries the current state of the list mode.

Return values:

<State>

0 | 1 | OFF | ON

1

Signal generation based on the list mode is active.

Example:

See [Example "Create an RF list and activate the list mode"](#) on page 842.

Usage:

Query only

12.16.11.2 List Mode File Operation

The following section covers basic commands to file handling in list mode.

<code>[[:SOURce<hw>]:LIST:CATalog?</code>	851
<code>[[:SOURce<hw>]:LIST:DELeTe</code>	851
<code>[[:SOURce<hw>]:LIST:DELeTe:ALL</code>	851
<code>[[:SOURce<hw>]:LIST:FREE?</code>	852
<code>[[:SOURce<hw>]:LIST:RESet</code>	852
<code>[[:SOURce<hw>]:LIST:SElect</code>	852

`[[:SOURce<hw>]:LIST:CATalog?`

Queries the available list files in the specified directory.

Return values:

<Catalog> string
 List of list filenames, separated by commas

Example: See [Example "Create an RF list and activate the list mode"](#) on page 842.

Usage: Query only

Manual operation: See "[List Mode Data](#)" on page 311

`[[:SOURce<hw>]:LIST:DELeTe <Filename>`

Deletes the specified list.

Setting parameters:

<Filename> string
 Filename or complete file path; file extension is optional.

Example: See `[[:SOURce<hw>]:LIST:DELeTe:ALL` on page 851.

Usage: Setting only

Manual operation: See "[List Mode Data](#)" on page 311

`[[:SOURce<hw>]:LIST:DELeTe:ALL`

Deletes all lists in the set directory.

This command can only be executed, if:

- No list file is selected.
- List mode is disabled.

Example:

```

SOUR1:LIST:CAT?
// list,my_list
SOUR1:LIST:DEL "/var/user/list1"
SOUR1:LIST:CAT?
// my_list
SOUR1:FREQ:MODE?
// LIST
SOUR1:LIST:SEL?
// /var/user/my_list.lsw
//deactivate list mode
SOUR1:FREQ:MODE CW
SOUR1:LIST:DELeTe:ALL
SOUR1:LIST:CAT?
// -
// all list files are deleted

```

Usage: Event

Manual operation: See " [List Mode Data](#) " on page 311

[[:SOURce<hw>]:LIST:FREE?

Queries the amount of free memory (in bytes) for list mode lists.

Return values:

```

<Free>          integer
                 Range:    0 to INT_MAX
                 *RST:    0

```

Example: See [Example "Create an RF list and activate the list mode"](#) on page 842.

Usage: Query only

[[:SOURce<hw>]:LIST:RESet

Jumps to the beginning of the list.

Example: See [Example "Create an RF list and activate the list mode"](#) on page 842.

Usage: Event

Manual operation: See " [Reset](#) " on page 310

[[:SOURce<hw>]:LIST:SElect <Filename>

Selects or creates a data list in list mode.

If the list with the selected name does not exist, a new list is created.

Parameters:

<Filename> string
 Filename or complete file path; file extension can be omitted.

Example: See [Example "Create an RF list and activate the list mode"](#) on page 842.

Manual operation: See "[List Mode Data](#)" on page 311

12.16.11.3 List Mode Data Exchange

With the following commands, you can configure lists in ASCII format and export or import them accordingly.

<code>[:SOURce<hw>] :LIST:DEXChange:AFILe:CATalog?</code>	853
<code>[:SOURce<hw>] :LIST:DEXChange:EXECute</code>	853
<code>[:SOURce<hw>] :LIST:DEXChange:AFILe:EXTension</code>	854
<code>[:SOURce<hw>] :LIST:DEXChange:AFILe:SElect</code>	854
<code>[:SOURce<hw>] :LIST:DEXChange:AFILe:SEParator:COLumn</code>	854
<code>[:SOURce<hw>] :LIST:DEXChange:AFILe:SEParator:DECimal</code>	854
<code>[:SOURce<hw>] :LIST:DEXChange:MODE</code>	855
<code>[:SOURce<hw>] :LIST:DEXChange:SElect</code>	855

[:SOURce<hw>] :LIST:DEXChange:AFILe:CATalog?

Queries the available ASCII files for export or import of list mode data in the current or specified directory.

Return values:

<Catalog> string
 List of ASCII files *.txt or *.csv, separated by commas.

Example: See [Example "List mode data exchange"](#) on page 844.

Usage: Query only

Manual operation: See "[Select \(ASCII\) Source/Select \(ASCII\) Destination](#)" on page 313

[:SOURce<hw>] :LIST:DEXChange:EXECute

Executes the import or export of the selected list file, according to the previously set transfer direction with command `[:SOURce<hw>] :LIST:DEXChange:MODE`

Example: See [Example "List mode data exchange"](#) on page 844.

Usage: Event

Manual operation: See "[Import / Export](#)" on page 313

[:SOURce<hw>]:LIST:DEXChange:AFILe:EXTension <Extension>

Determines the extension of the ASCII file for import or export, or to query existing files.

Parameters:

<Extension> TXT | CSV
*RST: TXT

Example: See [Example "List mode data exchange"](#) on page 844.

Manual operation: See ["ASCII File Settings"](#) on page 313

[:SOURce<hw>]:LIST:DEXChange:AFILe:SElect <Filename>

Selects the ASCII file to be imported or exported.

Parameters:

<Filename> string
Filename or complete file path; file extension can be omitted.

Example: See [Example "List mode data exchange"](#) on page 844.

Manual operation: See ["Select \(ASCII\) Source/Select \(ASCII\) Destination"](#) on page 313

[:SOURce<hw>]:LIST:DEXChange:AFILe:SEParator:COLumn <Column>

Selects the separator between the frequency and level column of the ASCII table.

Parameters:

<Column> TABulator | SEMicolon | COMMa | SPACe
*RST: COMMa

Example: See [Example "List mode data exchange"](#) on page 844.

Manual operation: See ["ASCII File Settings"](#) on page 313

[:SOURce<hw>]:LIST:DEXChange:AFILe:SEParator:DECimal <Decimal>

Sets "." (decimal point) or "," (comma) as the decimal separator used in the ASCII data with floating-point numerals.

Parameters:

<Decimal> DOT | COMMa
*RST: DOT

Example: See [Example "List mode data exchange"](#) on page 844.

Manual operation: See ["ASCII File Settings"](#) on page 313

[:SOURce<hw>]:LIST:DEXChange:MODE <Mode>

Determines the import or export of a list.

Specify the source or destination file with the command `[:SOURce<hw>] :LIST:DEXChange:SElect`.

Parameters:

<Mode> IMPort | EXPort
*RST: IMPort

Example: See [Example "List mode data exchange"](#) on page 844.

Manual operation: See [" Mode "](#) on page 312

[:SOURce<hw>]:LIST:DEXChange:SElect <Filename>

Selects the ASCII file for import or export, containing a list.

Parameters:

<Filename> string
 Filename or complete file path; file extension can be omitted.

Example: See [Example "List mode data exchange"](#) on page 844.

Manual operation: See ["Select Source/Select ASCII Destination"](#) on page 313

12.16.12 SOURce:NOISe Subsystem

The SOURce:NOISe subsystem contains the commands for setting the noise modulation signal. The noise generator is optional.

Example: Configuring the noise generator

```
SOURce1:NOISe:DIStributioN GAUSS
SOURce1:NOISe:BANdwidth 10000000
SOURce1:NOISe:BANdwidth:STATe 1
```

```
SOURce1:LFOutput1:SOURce NOIS
SOURce1:LFOutput1:STATe 1
```

```
SOURce1:NOISe:LEVel:RELative?
// -83.86
SOURce1:NOISe:LEVel:ABSolute?
// -13.86
```

<code>[:SOURce<hw>]:NOISe:BANdwidth BWIDth</code>	856
<code>[:SOURce<hw>]:NOISe:BWIDth:STATe</code>	856
<code>[:SOURce<hw>]:NOISe:DIStributioN</code>	856
<code>[:SOURce<hw>]:NOISe:LEVel:RELative?</code>	856
<code>[:SOURce<hw>]:NOISe:LEVel[ABSolute]?</code>	857

[[:SOURce<hw>]:NOISe:BANDwidth|BWIDTH <BWidth>

Sets the noise level in the system bandwidth when bandwidth limitation is enabled.

Parameters:

<BWidth>	float
	Range: 100E3 to 10E6
	Increment: 100E3
	*RST: 100E3

Example: See [Example "Configuring the noise generator"](#) on page 855.

Manual operation: See ["Bandwidth"](#) on page 341

[[:SOURce<hw>]:NOISe:BWIDth:STATe <State>

Activates noise bandwidth limitation.

Parameters:

<State>	0 1 OFF ON
	*RST: 0

Example: See [Example "Configuring the noise generator"](#) on page 855.

Manual operation: See ["Bandwidth"](#) on page 341

[[:SOURce<hw>]:NOISe:DISTRibution <Distribution>

Sets the distribution of the noise power density.

Parameters:

<Distribution>	GAUSSs EQUal
	*RST: GAUSSs

Example: See [Example "Configuring the noise generator"](#) on page 855.

Manual operation: See ["Distribution"](#) on page 340

[[:SOURce<hw>]:NOISe:LEVel:RELative?

Queries the level of the noise signal per Hz in the total bandwidth.

Return values:

<Relative>	float
	Range: -149.18 to -52.67
	Increment: 0.1
	*RST: -69.84

Example: See [Example "Configuring the noise generator"](#) on page 855.

Usage: Query only

Manual operation: See ["Noise Density"](#) on page 343

[[:SOURce<hw>]:NOISe:LEVel[:ABSolute]]?

Queries the level of the noise signal in the system bandwidth within the enabled bandwidth limitation.

Return values:

<Absolute> float
Noise level within the bandwidth limitation
*RST: 3.84 MHz

Example: See [Example "Configuring the noise generator"](#) on page 855.

Usage: Query only

Manual operation: See ["Noise Level"](#) on page 343

12.16.13 SOURce:PGEN Subsystem

The PGEN subsystem contains the commands for setting output of the pulse modulation signal.

Example: Using pulse generator as source for pulse modulation

```
// select pulse generator as source for pulse modulation
// enable pulse modulation
SOURce1:PULM:SOURce INT
SOURce1:PULM:STATe 1
// pulse generator and signal output are also activated
SOURce1:PGENerator:STATe?
// 1
SOURce1:PGENerator:OUTPut:STATe?
// 1
PGENerator:OUTPut:POLarity NORMal
// to disable pulse generator
SOURce1:PGENerator:STATe 0
// activate the pulse modulation of the RF carrier
SOURce1:PULM:STATe 1
```

[[:SOURce<hw>]:PGENerator:OUTPut:POLarity]..... 857
[[:SOURce<hw>]:PGENerator:OUTPut[:STATe]]..... 858
[[:SOURce<hw>]:PGENerator:STATe]..... 858

[[:SOURce<hw>]:PGENerator:OUTPut:POLarity <Polarity>

Sets the polarity of the pulse output signal.

Parameters:

<Polarity> NORMal | INVerted

NORMal

Outputs the pulse signal during the pulse width, that means during the high state.

INVerted

Inverts the pulse output signal polarity. The pulse output signal is suppressed during the pulse width, but provided during the low state.

*RST: NORMal

Example:See [Example "Using pulse generator as source for pulse modulation"](#) on page 857.**Manual operation:** See ["Pulse Output Polarity"](#) on page 333**[[:SOURce<hw>]:PGENERator:OUTPUT[:STATe] <State>**

Activates the output of the pulse modulation signal.

Parameters:

<State> 0 | 1 | OFF | ON

*RST: 0

Example:See [Example "Using pulse generator as source for pulse modulation"](#) on page 857.**Manual operation:** See ["Pulse Output State"](#) on page 333**[[:SOURce<hw>]:PGENERator:STATe <State>**

Enables the output of the video/sync signal.

If the pulse generator is the current modulation source, activating the pulse modulation automatically activates the signal output and the pulse generator.

Parameters:

<State> 0 | 1 | OFF | ON

*RST: 0

Example:See [Example "Using pulse generator as source for pulse modulation"](#) on page 857.

12.16.14 SOURce:PHASe Subsystem

This subsystem contains the commands for adjusting the phase of the RF output signal relative to a reference signal of the same frequency.

Example: Programming Example

```
// change the phase relative to the current phase
SOURce1:PHASe 2 DEG
// adopt the setting as the current phase
SOURce1:PHASe:REFerence
```

The following commands are available:

[:SOURce<hw>]:PHASe	859
[:SOURce<hw>]:PHASe:REFerence	859

[:SOURce<hw>]:PHASe <Phase>

Specifies the phase variation relative to the current phase.

Parameters:

<Phase>	float
Range:	-720 to 720
Increment:	0.1
*RST:	0
Default unit:	DEG

Example: See [Example "Programming Example"](#) on page 859.

Manual operation: See ["Delta Phase"](#) on page 271

[:SOURce<hw>]:PHASe:REFerence

Assigns the value set with command [\[:SOURce<hw>\]:PHASe](#) as the reference phase.

Example: See [Example "Programming Example"](#) on page 859.

Usage: Event

Manual operation: See ["Reset Delta Phase Display"](#) on page 271

12.16.15 SOURce:POWer Subsystem

The `SOURce:POWer` subsystem contains the commands for setting the output level, level control and level correction of the RF signal.

The default units are dBm. To change the units, perform one of the following:

- Enter the unit after the numerical value
Example: `:POW 0.5V`
- Set the unit with the command `:UNIT:POWer`.

[:SOURce<hw>]:POWer:ALC[:STATe]	860
[:SOURce<hw>]:POWer:ALC:DSEnsitivity	861
[:SOURce<hw>]:POWer:ALC:SONCe	861
[:SOURce<hw>]:POWer:ALC:SLEVel	862
[:SOURce<hw>]:POWer:ATTenuation:DIGital	862

<code>[:SOURce<hw>]:POWer:ATTenuation:RFOff:MODE</code>	862
<code>[:SOURce<hw>]:POWer:EMF:STATe</code>	863
<code>[:SOURce<hw>]:POWer:LBEHaviour</code>	863
<code>[:SOURce<hw>]:POWer:LIMit[:AMPLitude]</code>	863
<code>[:SOURce<hw>]:POWer:LMODe</code>	864
<code>[:SOURce<hw>]:POWer:MANual</code>	864
<code>[:SOURce<hw>]:POWer:MODE</code>	864
<code>[:SOURce<hw>]:POWer:PEP?</code>	865
<code>[:SOURce<hw>]:POWer:POWer</code>	865
<code>[:SOURce<hw>]:POWer:STARt</code>	866
<code>[:SOURce<hw>]:POWer:STOP</code>	866
<code>[:SOURce<hw>]:POWer:STEP:MODE</code>	866
<code>[:SOURce<hw>]:POWer:STEP[:INCRement]</code>	867
<code>[:SOURce<hw>]:POWer[:LEVel][:IMMediate]:OFFSet</code>	867
<code>[:SOURce<hw>]:POWer[:LEVel][:IMMediate]:RCL</code>	868
<code>[:SOURce<hw>]:POWer[:LEVel][:IMMediate][:AMPLitude]</code>	868
<code>[:SOURce<hw>]:POWer:RANGe:LOWer?</code>	869
<code>[:SOURce<hw>]:POWer:RANGe:UPPer?</code>	869
<code>[:SOURce]:POWer:WIGNore</code>	869

`[:SOURce<hw>]:POWer:ALC[:STATe] <State>`

Activates automatic level control in the selected mode.

Note: The ALC states `POW:ALC:STAT OFF` and `POW:ALC:STAT ONS` use a short sample pulse to set the level control. The level of this sample pulse corresponds to the sample level setting of the full PEP of the R&S SMBV100B. It does not consider any signal headroom, e.g. applied to a user-defined ARB waveform.

NOTICE: Risk of DUT damage due to high input power

If you generate signals with large headroom using `POW:ALC:SLEV FULL` in combination with `POW:ALC:STAT OFF` or `POW:ALC:STAT ONS`, the R&S SMBV100B generates a short sample pulse with full RF output power.

To protect the DUT from damage due to high input power, use the setting `POW:ALC:SLEV ATT` or `POW:ALC:SLEV MIN`.

Parameters:

<State>

AUTO | OFFTable | ON | ONSample | ONTable

AUTO

Adjusts the output level to the operating conditions automatically.

OFFTable

Controls the level with the attenuation values of the internal ALC table.

ON

Activates internal level control permanently.

ONSample

Starts the internal level control with the first change.

ONTable

Starts with the attenuation setting from the table and continues with automatic level control.

*RST: AUTO

Example:

POW:ALC ON

Activates internal level control.

Manual operation:

See "State" on page 350

[:SOURce<hw>]:POWER:ALC:DSENSitivity <Sensitivity>

Sets the sensitivity of the ALC detector.

Parameters:

<Sensitivity>

AUTO | FIXed

AUTO

Selects the optimum sensitivity automatically.

FIXed

Fixes the internal level detector.

*RST: AUTO

Example:

POW:ALC:DSEN FIX

Manual operation:

See "Detector Sensitivity" on page 351

[:SOURce<hw>]:POWER:ALC:SONCe

Activates level control for correction purposes temporarily.

Example:

POW:ALC OFF

Deactivates automatic level control at the RF output.

POW:ALC:SONC

Executes level control (once).

Usage:

Event

Manual operation:

See "Readjust" on page 270

```
[SOURce<hw>]:POWer:ALC:SLEVel <SampLevel>
```

Sets the sample level of automatic level control (ALC).

NOTICE: Risk of DUT damage due to high input power

If you generate signals with large headroom using `POW:ALC:SLEV FULL` in combination with `POW:ALC:STAT OFF` or `POW:ALC:STAT ONS`, the R&S SMBV100B generates a short sample pulse with full RF output power.

To protect the DUT from damage due to high input power, use the setting `POW:ALC:SLEV ATT` or `POW:ALC:SLEV MIN`.

Parameters:

<SampLevel> FULL | MINimum | ATTenuated
*RST: FULL

Example: `POW:ALC:SLEV MIN`
Sets the automatic level control to minimum.

Manual operation: See "Sample Level" on page 352

```
[SOURce<hw>]:POWer:ATTenuation:DIGital <AttDigital>
```

Sets a relative attenuation value for the baseband signal.

Parameters:

<AttDigital> float
Range: -3.522 to 80
Increment: 1E-3
*RST: 0

Manual operation: See "Digital Attenuation" on page 268

```
[SOURce<hw>]:POWer:ATTenuation:RFOff:MODE <Mode>
```

Selects the state the attenuator is to assume if the RF signal is switched off.

Parameters:

<Mode> UNCHanged | FATTenuation
FATTenuation
The attenuator switches to maximum attenuation
UNCHanged
Retains the current setting and keeps the output impedance constant during RF off.
*RST: n.a. (factory preset: FATTenuation)

Example: `SOURce1:POWer:ATTenuation:RFOff:MODE FATTenuation`
// maximum attenuation is used when the RF output is deactivated

Manual operation: See "RF OFF Mode" on page 348

[[:SOURce<hw>]:POWER:EMF:STATe <State>

Displays the signal level as voltage of the EMF. The displayed value represents the voltage over a 50 Ohm load.

Parameters:

<State> 0 | 1 | OFF | ON
 *RST: n.a. (factory preset: 0)

Example:

POW:EMF:STAT 1
 Activates voltage level display.

Manual operation: See " [Display Level as Voltage of EMF](#) " on page 484

[[:SOURce<hw>]:POWER:LBEHaviour <Behaviour>

Selects the level behavior at the RF output over time.

Parameters:

<Behaviour> AUTO | UNINterrupted | MONotone | CVSWr | USER

UNINterrupted|MONotone

Do not use the uninterrupted level settings and strictly monotone modes in combination with the high-quality optimization mode (see [[:SOURce<hw>]:BB:IMPairment:OPTimization:MODE on page 798).

CVSWr

Constant VSWR

USER

Read only

*RST: AUTO

Example:

SOURce1:POWER:LBEHaviour AUTO

Manual operation: See " [Setting Characteristics](#) " on page 268

[[:SOURce<hw>]:POWER:LIMit[:AMPLitude] <Amplitude>

Limits the maximum RF output level in CW and sweep mode.

It does not influence the "Level" display or the response to the query [[:SOURce<hw>]:POWER[:LEVel] [:IMMediate] [:AMPLitude].

Parameters:

<Amplitude> float
 Range: depends on the installed options
 Increment: 0.01
 *RST: n.a. (factory preset: 30)

Example:

SOURce1:POWER:LIMit:AMPLitude 10

Manual operation: See " [Limit](#) " on page 267

[:SOURce<hw>] :POWER:LMODe <LevMode>

Sets the RF level mode.

Parameters:

<LevMode> NORMAl | LOWNoise | LOWDistortion

NORMAl

Supplies the RF signal with the standard power level of the instrument.

LOWNoise

Supplies a very low noise sinewave signal.

LOWDistortion

Supplies a very pure sinewave signal.

*RST: NORMAl

Example:

SOURce1:POWER:LMODe LOWD

Sets low distortion mode. The instrument reduces distortions of the RF signal to a minimum.

Manual operation: See " [Mode](#) " on page 269

[:SOURce<hw>] :POWER:MANual <Manual>

Sets the level for the subsequent sweep step if [SWE:POW:MODE MAN](#).

Use a separate command for each sweep step.

Parameters:

<Manual> float

You can select any level within the setting range, where:

START is set with [:SOURce<hw>] :POWER:START

STOP is set with [:SOURce<hw>] :POWER:STOP

OFFSet is set with [:SOURce<hw>] :POWER [:LEVel] [:IMMediate] :OFFSet

Range: (START + OFFSet) to (STOP + OFFSet)

Increment: 0.01

Default unit: dBm

Example:

See [Example "Setup an RF frequency or power sweep"](#) on page 875

Manual operation: See " [Current Level](#) " on page 302

[:SOURce<hw>] :POWER:MODE <Mode>

Selects the operating mode of the instrument to set the output level.

Parameters:

<Mode> CW | FIXed | SWEep

CW|FIXed

Operates at a constant level.

CW and FIXed are synonyms.

To set the output level value, use the command [:SOURce<hw>] :POWer [:LEVel] [:IMMediate] [:AMPLitude].

SWEep

Sets sweep mode.

Set the range and current level with the commands:

[:SOURce<hw>] :POWer:STARt and [:SOURce<hw>] :POWer:STOP,
[:SOURce<hw>] :POWer:MANual.

*RST: CW

Example: See [Example "Setup an RF frequency or power sweep"](#) on page 875

Manual operation: See ["State \(RF level sweep\)"](#) on page 301

[:SOURce<hw>] :POWer:PEP?

Queries the PEP (Peak Envelope Power) of digital modulation or digital standards at the RF output. This value corresponds to the level specification, displayed in the status bar (header).

Return values:

<Pep> float

Example:

POW:PEP?

Response: "4"

The PEP value of digital modulation is 4 dBm at the RF output.

Usage:

Query only

[:SOURce<hw>] :POWer:POWer <Power>

Sets the level at the RF output connector.

This value does not consider a specified offset.

The command [:SOURce<hw>] :POWer [:LEVel] [:IMMediate] [:AMPLitude] sets the level of the "Level" display, that means the level containing offset.

See ["RF frequency and level display with a downstream instrument"](#) on page 262.

Parameters:

<Power> float
 Level at the RF output, without level offset
 Range: See data sheet
 Increment: 0.01
 Default unit: dBm

Example:

SOURce1:POWer:POWer 15
 Sets the level at RF output

Manual operation: See "[Amplitude](#)" on page 267

[:SOURce<hw>]:POWer:START <Start>

[:SOURce<hw>]:POWer:STOP <Stop>

Sets the RF start/stop level in sweep mode.

Parameters:

<Stop> float
 Sets the setting range calculated as follows:
 (Level_min + OFFSet) to (Level_max + OFFSet)
 Where the values are set with the commands:
[\[:SOURce<hw>\]:POWer\[:LEVel\]\[:IMMediate\]:OFFSet](#)
[\[:SOURce<hw>\]:POWer:START](#)
[\[:SOURce<hw>\]:POWer:STOP](#)
 Range: Minimum level to maximum level
 *RST: -30 (Start)/ -10 (Stop)
 Default unit: dBm

Example:

See [Example "Setup an RF frequency or power sweep"](#) on page 875

Manual operation: See "[Start Level / Stop Level](#)" on page 308

[:SOURce<hw>]:POWer:STEP:MODE <Mode>

Defines the type of step width to vary the RF output power step-by-step with the commands [POW UP](#) or [POW DOWN](#).

Parameters:

<Mode> DECimal | USER
DECimal
 Increases or decreases the level in steps of ten.
USER
 Increases or decreases the level in increments, determined with the command [\[:SOURce<hw>\]:POWer:STEP\[:INCRement\]](#).
 *RST: DECimal

Example:

```
// increasing the RF level with a step size of 2 dB
SOURce1:POWer:STEP:INCRement 2
SOURce1:POWer:STEP:MODE USER
SOURce1:POWer:LEVel:IMMediate:AMPLitude UP
```

Manual operation: See "[Variation Active](#)" on page 265

[:SOURce<hw>]:POWer:STEP[:INCRement] <Increment>

Specifies the step width in the appropriate path for `POW:STEP:MODE USER`.

To adjust the level step-by-step with this increment value, use the command `POW UP`, or `POW DOWN`.

Note: The command also sets "Variation Step" in the manual control, that means the user-defined step width for setting the level with the rotary knob or the [Up/Down] arrow keys.

Parameters:

<Increment>	float
	Range: 0 to 100
	Increment: 0.01
	*RST: 1
	Default unit: dB

Example: See `[:SOURce<hw>] :POWer:STEP:MODE` on page 866.

Manual operation: See "[Variation Step](#)" on page 265

[:SOURce<hw>]:POWer[:LEVel][:IMMediate]:OFFSet <Offset>

Sets the level offset of a downstream instrument.

The level at the RF output is not changed.

To query the resulting level, as it is at the output of the downstream instrument, use the command `[:SOURce<hw>] :POWer [:LEVel] [:IMMediate] [:AMPLitude]`.

See "[RF frequency and level display with a downstream instrument](#)" on page 262.

Note: The level offset also affects the RF level sweep.

Parameters:

<Offset>	float
	Range: -200 to 200
	Increment: 0.01
	*RST: 0
	Default unit: dB
	Level offset is always expreced in dB; linear units (V, W, etc.) are not supported

Example:

```
POWer:OFFSet 10
Sets the RF level offset to 10 dB
```

Manual operation: See "[Offset](#)" on page 268

[:SOURce<hw>]:POWER[:LEVel][:IMMediate]:RCL <Rcl>

Determines whether the current level is retained or if the stored level setting is adopted when an instrument configuration is loaded.

Parameters:

<Rcl> INCLude | EXCLude

INCLude

Takes the current level when an instrument configuration is loaded.

EXCLude

Retains the current level when an instrument configuration is loaded.

*RST: INCLude

Example:

POW:RCL INCL

Takes the level value from an instrument configuration loaded with command *RCL.

Manual operation: See "Exclude Level" on page 455

[:SOURce<hw>]:POWER[:LEVel][:IMMediate][:AMPLitude] <Amplitude>

Sets the RF level applied to the DUT.

To activate the RF output use command :OUTPut<hw>[:STATe] ("RF On"/"RF Off").

The following applies $POWER = RF \text{ output level} + OFFSET$, where:

- POWER is the values set with [:SOURce<hw>]:POWER[:LEVel][:IMMediate][:AMPLitude]
- RF output level is set with [:SOURce<hw>]:POWER:POWER
- OFFSET is set with [:SOURce<hw>]:POWER[:LEVel][:IMMediate]:OFFSET

Parameters:

<Amplitude> float

The following settings influence the value range:

OFFSET set with the command [:SOURce<hw>]:POWER[:LEVel][:IMMediate]:OFFSET

Numerical value

Sets the level

UP|DOWN

Varies the level step by step.

The level is increased or decreased by the value set with the command [:SOURce<hw>]:POWER:STEP[:INCRement].

Range: (Level_min + OFFSET) to (Level_max + OFFSET)

*RST: -30

Default unit: dBm

Example:

POWER -30

Sets the RF level

Example: See also [:SOURce<hw>]:POWer:STEP:MODE on page 866.

Manual operation: See "Amplitude" on page 267

[:SOURce<hw>]:POWer:RANGe:LOWer?

[:SOURce<hw>]:POWer:RANGe:UPPer?

Queries the current interruption-free range of the level.

Return values:

<Upper> float
 Increment: 0.01
 Default unit: dBm

Example:

```
SOURce1:POWer:RANGe:UPPer?
// -15
SOURce1:POWer:RANGe:LOW?
// -50
```

Usage: Query only

Manual operation: See "Level Range" on page 269

[:SOURce]:POWer:WIGNore <State>

Ignores level range warnings.

Parameters:

<State> 0 | 1 | OFF | ON
 *RST: n.a. (factory preset: 0)

Example: SOURce:POWer:WIGNore 1

12.16.16 SOURce:ROSCillator Subsystem

The SOURce:ROSCillator subsystem contains the commands for setting the external and internal reference frequency.



The commands of this subsystem are not affected by an instrument reset (*RST on page 583).

Example: Configuring the reference oscillator

```
// Using 100 MHz external reference source
SOURce:ROSCillator:PRESet
SOURce:ROSCillator:SOURce EXT
SOURce:ROSCillator:EXTernal:RFOff:STATe 1
SOURce:ROSCillator:EXTernal:FREQuency 100MHZ
SOURce:ROSCillator:EXTernal:SBANdwidth WIDE
// 100 MHz (loop thought) and 1 GHz output
SOURce:ROSCillator:OUTPut:FREQuency:MODE LOOP
SOURce:ROSCillator:OUTPut:ALternate:FREQuency:MODE DER1G
SOURce:ROSCillator:INTernal:ADJust:STATe 0

// Variable external reference frequency
// SOURce:ROSCillator:EXTernal:FREQuency VAR
// SOURce:ROSCillator:EXTernal:FREQuency:VARIABLE 100000000

// Using the internal reference frequency
SOURce:ROSCillator:SOURce INT
SOURce:ROSCillator:INTernal:TUNing:STATe 1
SOURce:ROSCillator:INTernal:TUNing:SLOPe LOW
// 10 MHz and 1 GHz output
SOURce:ROSCillator:OUTPut:FREQuency:MODE DER10M
SOURce:ROSCillator:OUTPut:ALternate:FREQuency:MODE DER1G
```

[:SOURce]:ROSCillator:PRESet	870
[:SOURce]:ROSCillator:SOURce	870
[:SOURce]:ROSCillator:EXTernal:RFOff[:STATe]	871
[:SOURce]:ROSCillator:EXTernal:FREQuency	871
[:SOURce]:ROSCillator:EXTernal:FREQuency:VARIABLE	871
[:SOURce]:ROSCillator:EXTernal:SBANdwidth	872
[:SOURce]:ROSCillator:EXTernal:MLRange?	872
[:SOURce]:ROSCillator:EXTernal:NSBandwidth?	872
[:SOURce]:ROSCillator:OUTPut:FREQuency:MODE	872
[:SOURce]:ROSCillator:OUTPut:ALternate:FREQuency:MODE	873
[:SOURce]:ROSCillator[:INTernal]:ADJust:VALue	873
[:SOURce]:ROSCillator[:INTernal]:ADJust[:STATe]	874

[:SOURce]:ROSCillator:PRESet

Resets the reference oscillator settings.

Example: See [Example "Configuring the reference oscillator"](#) on page 870.

Usage: Event

Manual operation: See ["Set to Default"](#) on page 276

[:SOURce]:ROSCillator:SOURce <Source>

Selects between internal or external reference frequency.

Parameters:

<Source> INTernal | EXTernal
 *RST: n.a. (factory preset: INTernal)

Example: See [Example "Configuring the reference oscillator"](#) on page 870.

Manual operation: See ["Source"](#) on page 276

[[:SOURce]:ROSCillator:EXTernal:RFOFF[:STATe] <State>

Determines that the RF output is turned off when the external reference signal is selected, but missing.

Parameters:

<State> 0 | 1 | OFF | ON
 *RST: n.a. (factory preset: 0)

Example: See [Example "Configuring the reference oscillator"](#) on page 870.

Manual operation: See ["Deactivate RF Output \(if external reference is missing\)"](#) on page 276

[[:SOURce]:ROSCillator:EXTernal:FREQUENCY <Frequency>

Sets the frequency of the external reference.

Parameters:

<Frequency> 100MHZ | 1GHZ | VARiable | 10MHZ
 *RST: n.a. (factory preset: 10MHZ)

Example: See [Example "Configuring the reference oscillator"](#) on page 870.

Options: VARiable requires R&S SMBVB-K704
 1GHZ requires R&S SMBVB-B3

Manual operation: See ["External Reference Frequency"](#) on page 276

[[:SOURce]:ROSCillator:EXTernal:FREQUENCY:VARiable <Frequency>

Specifies the user-defined external reference frequency.

Parameters:

<Frequency> float
 Range: 1E6 to 100E6
 Increment: 0.1
 *RST: n.a. (factory preset: 1E7)
 Default unit: Hz

Example: See [Example "Configuring the reference oscillator"](#) on page 870.

Options: R&S SMBVB-K704

Manual operation: See ["Variable Reference Frequency"](#) on page 277

[[:SOURce]:ROSCillator:EXTernal:SBANDwidth <SBandwidth>

Selects the synchronization bandwidth for the external reference signal.

For more information, see data sheet.

Parameters:

<SBandwidth> WIDE | NARRow

NARRow

The synchronization bandwidth is a few Hz.

Suitable for external reference sources with phase noise worse than the R&S SMBV100B.

WIDE

Uses the widest possible synchronization bandwidth.

For more information, see data sheet.

*RST: n.a. (factory preset)

Example: See [Example "Configuring the reference oscillator"](#) on page 870.

Manual operation: See ["Synchronization Bandwidth"](#) on page 277

[[:SOURce]:ROSCillator:EXTernal:MLRange?

Queries the minimum locking range for the selected external reference frequency.

Return values:

<MinLockRange> string

Example: SOUR:ROSC:EXT:MLR?

Usage: Query only

Manual operation: See ["Minimum Locking Range"](#) on page 277

[[:SOURce]:ROSCillator:EXTernal:NSBandwidth?

Queries the nominal synchronization bandwidth for the selected external reference frequency and synchronization bandwidth.

Return values:

<NomBandwidth> string

Example: SOUR:ROSC:EXT:NSB?

Usage: Query only

Manual operation: See ["Nominal Synchronization Bandwidth"](#) on page 277

[[:SOURce]:ROSCillator:OUTPut:FREQuency:MODE <OutpFreqMode>

Selects the mode for the output reference frequency.

Parameters:

<OutpFreqMode> DER10M | OFF | LOOPthrough

OFF
Disables the output.

DER10M
Sets the output reference frequency to 10 MHz.
The reference frequency is derived from the internal reference frequency.

LOOPthrough
This option is unavailable for
ROSCillator:EXTernal:FREQuency 1GHZ. Forwards the
input reference frequency to the reference frequency output.

*RST: n.a. (factory preset: DER10M)

Example: See [Example "Configuring the reference oscillator"](#) on page 870.

Manual operation: See ["Reference Output/1GHz Reference Output"](#) on page 278

[:SOURce]:ROSCillator:OUTPut:ALternate:FREQuency:MODE <OutpFreqMode>

Sets the output reference frequency.

Parameters:

<OutpFreqMode> LOOPthrough | DER1G | OFF

OFF
Disables the output.

DER1G
Sets the output reference frequency to 1 GHz.
The reference frequency is derived from the internal reference frequency.

LOOPthrough
If [:SOURce]:ROSCillator:EXTernal:FREQuency1GHZ,
forwards the input reference frequency to the reference frequency output.

*RST: n.a. (factory preset: OFF)

Example: See [Example "Configuring the reference oscillator"](#) on page 870.

Options: DER1G requires R&S SMBVB-B3

Manual operation: See ["Reference Output/1GHz Reference Output"](#) on page 278

[:SOURce]:ROSCillator[:INTernal]:ADJust:VALue <Value>

Specifies the frequency correction value (adjustment value).

Parameters:

<Value> integer

*RST: 0

Example: See `[:SOURce] :ROSCillator [:INTernal] :ADJust [:STATe]` on page 874

Manual operation: See "Adjustment Value" on page 279

`[:SOURce] :ROSCillator [:INTernal] :ADJust [:STATe] <State>`

Determines whether the calibrated (off) or a user-defined (on) **adjustment value** is used for fine adjustment of the frequency.

Parameters:

<State> 0 | 1 | OFF | ON

0

Fine adjustment with the calibrated frequency value

1

User-defined adjustment value

The instrument is no longer in the calibrated state.

The calibration value is, however, not changed. The instrument resumes the calibrated state if you send

`SOURce:ROSCillator:INTernal:ADJust:STATe 0.`

*RST: n.a. (factory preset: 0)

Example:

```
// query calibration value
CALibration:ROSCillator?
// 32767
// Set an internal source
// Activate user-defined adjustment value of 1000
SOURce:ROSCillator:SOURce INT
SOURce:ROSCillator:INTernal:ADJust:STATe 1
SOURce:ROSCillator:INTernal:ADJust:VALue 1000

// to resume calibrated state
SOURce:ROSCillator:INTernal:ADJust:VALue 0
SOURce:ROSCillator:INTernal:ADJust:STATe 0
// or
// SYSTem:FPRest
```

Manual operation: See "Adjustment Active" on page 279

12.16.17 SOURce:SWEep Subsystem

The `SOURce:SWEep` subsystem contains the commands for configuring RF sweep signals.



- The keyword [:FREQUENCY] can be omitted, then the commands are SCPI-compliant.
- To activate an RF sweep mode, use the following commands:
 - RF frequency sweep: SOURce:FREQuency:MODE SWEEp (SOURce:FREQuency:MODE CW (off))
 - RF level sweep: SOURce:POWer:MODE SWEEp (SOURce:POWer:MODE CW (off))
- All sweeps, including the LF sweep, can be set independently of each other.

For detailed information on the sweep modes and the triggering, see [Chapter 6.10.1, "Signal Generation and Triggering in the Sweep and List Modes"](#), on page 286.

Example: Setup an RF frequency or power sweep

The following example shows a command sequence to set up an RF frequency sweep, triggered by the execute command. For an RF power sweep, replace FREQUENCY in the SWEEp commands with POWer.

Exceptions are the power spacing (defined with LINear only) and the power step width (defined with LOGarithmic only).

```
// Reset the instrument to start from an initial state
// Switch off display update to improve performance
// (especially with short dwell times)
// Set the sweep mode (first two commands) and the sweep range
// Select linear spacing
// Select the waveform shape for the frequency sweep
*RST; *CLS
SYSTEM:DISPlay:UPDate OFF
TRIGger1:FSWEEP:SOURce SINGLE
SOURce1:SWEEp:FREQuency:MODE AUTO
SOURce1:FREQuency:SPAN 300 MHz
SOURce1:FREQuency:CENTer 200 MHz
// Alternatively use
// SOURce1:FREQuency:STARt 50 MHz
// SOURce1:FREQuency:STOP 350 MHz
SOURce1:SWEEp:FREQuency:SPACing LINear
SOURce1:SWEEp:FREQuency:SHAPE SAWTooth

// Activate change to start frequency while waiting for next trigger
// Prerequisites: sweep mode single and sweep waveform sawtooth
SOURce1:SWEEp:FREQuency:RETRace 1
// Alternatively reset all sweeps to their initial value
SOURce1:SWEEp:RESet:ALL

// Set the step width and dwell time
SOURce1:SWEEp:FREQuency:STEP:LINear 1 MHz
// Alternatively set the number of steps, then the sweep step width is
// set automatically
SOURce1:SWEEp:FREQuency:POINts 301
```

```

SOURce1:SWEep:FREQuency:DWELL 500 ms
// With logarithmic spacing select the step width as follows
// (steps of 10 percent of the previous frequency in each instance)
SOURce1:SWEep:FREQuency:SPACing LOG
SOURce1:SWEep:FREQuency:STEP:LOGarithmic 10PCT

// Activate the sweep
// Trigger the sweep (depending on the set mode) and query the status
SOURce1:FREQuency:MODE SWEep
// Perform a one-off RF frequency sweep
SOURce1:SWEep:FREQuency:EXECute
SOURce1:SWEep:FREQuency:RUNning?
// 1
// the frequency sweep is running

// For manual step RF sweep use the following commands
*RST; *CLS
// Activate manual step RF sweep
SOURce1:SWEep:FREQuency:MODE MANual
// Activate the RF frequency sweep.
SOURce1:FREQuency:MODE SWEep
// Activate RF Output1.
Output1:STATe 1
// Input the frequency manually for each step
SOURce1:FREQuency:MANual 200 MHz
SOURce1:FREQuency:MANual 201 MHz
// Alternatively use the UP or DOWN commands with the set step width.
SOURce1:SWEep:FREQuency:STEP:LINear 1 MHz
SOURce1:FREQuency:MANual UP

[:SOURce<hw>]:SWEep:POWer:DWELL.....877
[:SOURce<hw>]:SWEep:POWer:MODE.....877
[:SOURce<hw>]:SWEep:POWer:POINts.....877
[:SOURce<hw>]:SWEep:POWer:SPACing:MODE?.....878
[:SOURce<hw>]:SWEep:POWer:STEP[:LOGarithmic].....878
[:SOURce<hw>]:SWEep[:FREQuency]:DWELL.....878
[:SOURce<hw>]:SWEep[:FREQuency]:MODE.....878
[:SOURce<hw>]:SWEep[:FREQuency]:POINts.....879
[:SOURce<hw>]:SWEep[:FREQuency]:SPACing.....879
[:SOURce<hw>]:SWEep:POWer:SHApe.....880
[:SOURce<hw>]:SWEep[:FREQuency]:SHApe.....880
[:SOURce<hw>]:SWEep:POWer:EXECute.....880
[:SOURce<hw>]:SWEep[:FREQuency]:EXECute.....880
[:SOURce<hw>]:SWEep:POWer:RETRace.....881
[:SOURce<hw>]:SWEep[:FREQuency]:RETRace.....881
[:SOURce<hw>]:SWEep:POWer:RUNning?.....881
[:SOURce<hw>]:SWEep[:FREQuency]:RUNning?.....881
[:SOURce<hw>]:SWEep[:FREQuency]:STEP:LOGarithmic.....881
[:SOURce<hw>]:SWEep[:FREQuency]:STEP[:LINear].....881
[:SOURce<hw>]:SWEep:RESet[:ALL].....882

```

[:SOURce<hw>] :SWEep:POWer:DWELI <Dwell>

Sets the dwell time for a level sweep step.

Parameters:

<Dwell>	float
	Range: 0.005 to 100
	Increment: 100E-6
	*RST: 0.01

Manual operation: See " [Dwell Time](#) " on page 304

[:SOURce<hw>] :SWEep:POWer:MODE <Mode>

Sets the cycle mode for the level sweep.

Parameters:

<Mode>	AUTO MANual STEP
--------	----------------------

AUTO

Each trigger triggers exactly one complete sweep.

MANual

The trigger system is not active. You can trigger every step individually with the command `[:SOURce<hw>] :POWer:MANual`.

The level value increases at each step by the value that you define with `[:SOURce<hw>] :POWer:STEP [:INCRement]`.

Values directly entered with the command `[:SOURce<hw>] :POWer:MANual` are not taken into account.

STEP

Each trigger triggers one sweep step only. The level increases by the value entered with `[:SOURce<hw>] :POWer:STEP [:INCRement]`.

*RST:	AUTO
-------	------

Example: See [Example "Setup an RF frequency or power sweep"](#) on page 875.

Manual operation: See "[Mode](#)" on page 302

[:SOURce<hw>] :SWEep:POWer:POINts <Points>

Sets the number of steps within the RF level sweep range.

See [Chapter 6.10.2.1, "Correlating Parameters in Sweep Mode"](#), on page 294.

Parameters:

<Points>	integer
	Range: 2 to Max

Example: See [Example "Setup an RF frequency or power sweep"](#) on page 875.

[[:SOURce<hw>]:SWEep:POWer:SPACing:MODE?

Queries the level sweep spacing. The sweep spacing for level sweeps is always linear.

Return values:

<Mode> LINear
*RST: LINear

Example:

SWE:POW:SPAC:MODE?
queries the sweep spacing for a level sweep at RF output.
Result: "LIN"
linear spacing

Usage: Query only

[[:SOURce<hw>]:SWEep:POWer:STEP[:LOGarithmic] <Logarithmic>

Sets a logarithmically determined step size for the RF level sweep. The level is increased by a logarithmically calculated fraction of the current level.

See [Chapter 6.10.2.1, "Correlating Parameters in Sweep Mode"](#), on page 294.

Parameters:

<Logarithmic> float
The unit dB is mandatory.
Range: 0.01 to 139 dB
Increment: 0.01
*RST: 1
Default unit: dB

Example: See [Example "Setup an RF frequency or power sweep"](#) on page 875.

Manual operation: See "[Step](#)" on page 308

[[:SOURce<hw>]:SWEep[:FREQUENCY]:DWELI <Dwell>

Sets the dwell time for a frequency sweep step.

Parameters:

<Dwell> float
Range: 0.005 to 100
Increment: 100E-6
*RST: 0.01

Manual operation: See "[Dwell Time](#)" on page 304

[[:SOURce<hw>]:SWEep[:FREQUENCY]:MODE <Mode>

Sets the cycle mode for the frequency sweep.

Parameters:

<Mode> AUTO | MANual | STEP

AUTO

Each trigger event triggers exactly one complete sweep.

MANual

The trigger system is not active. You can trigger every step individually by input of the frequencies with the command [: SOURce<hw>] : FREQuency : MANual.

STEP

Each trigger event triggers one sweep step. The frequency increases by the value entered with [: SOURce<hw>] : SWEep [: FREQuency] : STEP [: LINear] (linear spacing) or [: SOURce<hw>] : SWEep [: FREQuency] : STEP : LOGarithmic (logarithmic spacing).

*RST: AUTO

Example: See [Example "Setup an RF frequency or power sweep"](#) on page 875.**Manual operation:** See ["Mode"](#) on page 302**[: SOURce<hw>] : SWEep [: FREQuency] : POINts <Points>**

Sets the number of steps within the RF frequency sweep range.

See [Chapter 6.10.2.1, "Correlating Parameters in Sweep Mode"](#), on page 294.

Two separate POINts values are used for linear or logarithmic sweep spacing ([: SOURce<hw>] : SWEep [: FREQuency] : SPACing LIN | LOG). The command always affects the currently set sweep spacing.

Parameters:

<Points> integer

Range: 2 to Max

Example: See [Example "Setup an RF frequency or power sweep"](#) on page 875.**[: SOURce<hw>] : SWEep [: FREQuency] : SPACing <Spacing>**

Selects the mode for the calculation of the frequency intervals, with which the current frequency at each step is increased or decreased.

The keyword [: FREQuency] can be omitted; then the command is SCPI-compliant.

Parameters:

<Spacing> LINear | LOGarithmic

LINear

Sets a fixed frequency value as step width and adds it to the current frequency.

The linear step width is entered in Hz, see [:SOURce<hw>]:SWEep[:FREQuency]:STEP[:LINear].

LOGarithmic

Sets a constant fraction of the current frequency as step width and adds it to the current frequency.

The logarithmic step width is entered in %, see [:SOURce<hw>]:SWEep[:FREQuency]:STEP:LOGarithmic.

*RST: LINear

Example:

See [Example "Setup an RF frequency or power sweep"](#) on page 875.

Manual operation: See "[Spacing](#)" on page 304

[:SOURce<hw>]:SWEep:POWer:SHAPE <Shape>

[:SOURce<hw>]:SWEep[:FREQuency]:SHAPE <Shape>

Determines the waveform shape for a frequency sweep sequence.

Parameters:

<Shape> SAWTooth | TRIangle

*RST: SAWTooth

Example:

See [Example "Setup an RF frequency or power sweep"](#) on page 875.

Manual operation: See "[Shape](#)" on page 303

[:SOURce<hw>]:SWEep:POWer:EXECute

[:SOURce<hw>]:SWEep[:FREQuency]:EXECute

Executes an RF frequency sweep.

The command performs a single sweep and is therefore only effective in manual sweep mode.

Example:

See [Example "Setup an RF frequency or power sweep"](#) on page 875.

Usage:

Event

Manual operation: See "[Execute Single Sweep](#)" on page 305

```
[:SOURce<hw>]:SWEep:POWer:RETRace <State>
```

```
[:SOURce<hw>]:SWEep[:FREQuency]:RETRace <State>
```

Activates that the signal changes to the start frequency value while it is waiting for the next trigger event.

You can enable this feature, when you are working with sawtooth shapes in sweep mode "Single" or "External Single".

Parameters:

```
<State>          0 | 1 | OFF | ON
                  *RST:      0
```

Example: See [Example "Setup an RF frequency or power sweep"](#) on page 875.

Manual operation: See ["Retrace"](#) on page 303

```
[:SOURce<hw>]:SWEep:POWer:RUNNING?
```

```
[:SOURce<hw>]:SWEep[:FREQuency]:RUNNING?
```

Queries the current sweep state.

Return values:

```
<State>          0 | 1 | OFF | ON
```

Example: See [Example "Setup an RF frequency or power sweep"](#) on page 875.

Usage: Query only

```
[:SOURce<hw>]:SWEep[:FREQuency]:STEP:LOGarithmic <Logarithmic>
```

Sets a logarithmically determined step width for the RF frequency sweep. The value is added at each sweep step to the current frequency.

See [Chapter 6.10.2.1, "Correlating Parameters in Sweep Mode"](#), on page 294.

Parameters:

```
<Logarithmic>   float
                  The unit is mandatory.
                  Range:      0.01 to 100
                  Increment:  1E-3
                  *RST:      1
                  Default unit: PCT
```

Example: See [Example "Setup an RF frequency or power sweep"](#) on page 875.

Manual operation: See [" Step Linear/Step Logarithmic "](#) on page 307

```
[:SOURce<hw>]:SWEep[:FREQuency]:STEP[:LINear] <Linear>
```

Sets the step width for linear sweeps.

See [Chapter 6.10.2.1, "Correlating Parameters in Sweep Mode"](#), on page 294.

Omit the optional keywords so that the command is SCPI-compliant.

Parameters:

<Linear> float
 Range: 0.001 Hz to (STOP - START)
 Increment: 0.01

Example: See [Example "Setup an RF frequency or power sweep"](#) on page 875.

Manual operation: See [" Step Linear/Step Logarithmic "](#) on page 307

[:SOURce<hw>]:SWEep:RESet[:ALL]

Resets all active sweeps to the starting point.

Usage: Event

Manual operation: See [" Reset Sweep "](#) on page 305

12.17 SYSTem Subsystem

The SYSTem subsystem contains a series of commands for general functions which do not directly affect signal generation.

Example: Retrieving information on network-related settings

```
SYSTem:COMMunicate:NETWork:STATus?
// 1
SYSTem:PROTection1:STATe 0,123456

SYSTem:COMMunicate:NETWork:IPAdDress:MODE STAT
SYSTem:COMMunicate:NETWork:IPAdDress "10.113.0.104"
SYSTem:COMMunicate:NETWork:IPAdDress:DNS "10.0.2.166"
SYSTem:COMMunicate:NETWork:COMMon:HOSTname?
// "SMBV100B-102030"
SYSTem:COMMunicate:NETWork:COMMon:WORKgroup "instrument"
SYSTem:COMMunicate:NETWork:COMMon:DOMain "rsint.net"
SYSTem:COMMunicate:NETWork:IPAdDress:GATeway "10.113.0.1"
SYSTem:COMMunicate:NETWork:IPAdDress:SUBNet:MASK "255.255.252.0"
SYSTem:COMMunicate:NETWork:MACaddress "08 00 27 a3 a1 70"
SYSTem:PROTection1:STATe 1
```

Example: Finding out the used VISA resource strings

```

SYSTem:COMMunicate:NETWork:RESource?
// "TCPIP::10.113.0.104::inst0::INSTR"

SYSTem:COMMunicate:HISLip:RESource?
// "TCPIP::10.113.0.104::hislip0::INSTR"

SYSTem:COMMunicate:GPIB:RESource?
// "GPIB::28::INSTR"
SYSTem:COMMunicate:GPIB:SELF:ADDRESS?
// 28
SYSTem:COMMunicate:GPIB:LTERminator?
// STAN

SYSTem:COMMunicate:SERial:RESource?
// "ASRL1::INSTR"
SYSTem:COMMunicate:SERial:SBITs?
// 1
SYSTem:COMMunicate:SERial:BAUD?
// 115200
SYSTem:COMMunicate:SERial:PARity?
// NONE

SYSTem:COMMunicate:SOCKeT:RESource?
// "TCPIP::10.113.0.104::5025::SOCKET"
SYSTem:COMMunicate:USB:RESource?
// "USB::0x0AAD:0x01df:100001::INSTR"

```

Example: Querying the error queue

```

SYSTem:ERRor:STATic?
// -221,"Settings conflict", 153,"Input voltage out of range", ...
// returns all static errors that are collected in the error queue

SYSTem:ERRor:HISTory?
// 90,"Info;(*)Instrument startup... (Mar-13-2017/ 10:25:16-601 ms)", ...
// returns all entries of the error queue

SYSTem:ERRor:HISTory:CLEar
// deletes the history entries

```

:SYSTem:ERRor:ALL?	885
:SYSTem:ERRor:CODE:ALL?	885
:SYSTem:ERRor:CODE[:NEXT]?	886
:SYSTem:ERRor:COUNT?	886
:SYSTem:ERRor[:NEXT]?	887
:SYSTem:ERRor:GNEXT?	887
:SYSTem:ERRor:HISTory?	887
:SYSTem:ERRor:HISTory:CLEar	888
:SYSTem:ERRor:STATic?	888

:SYSTem:ULOCK.....	888
:SYSTem:DLOCK.....	889
:SYSTem:KLOCK.....	889
:SYSTem:SAV.....	889
:SYSTem:RCL.....	889
:SYSTem:PROTect<ch>[:STATe].....	890
:SYSTem:SECurity:VOLMode[:STATe].....	890
:SYSTem:COMMunicate:GPIB:LTERminator.....	891
:SYSTem:COMMunicate:GPIB:RESource?.....	891
:SYSTem:COMMunicate:GPIB[:SELF]:ADDRes.....	891
:SYSTem:COMMunicate:HISLip:RESource?.....	892
:SYSTem:COMMunicate:NETWork:IPADdress.....	892
:SYSTem:COMMunicate:NETWork:IPADdress:MODE.....	892
:SYSTem:COMMunicate:NETWork:MACAddress.....	892
:SYSTem:COMMunicate:NETWork:RESource?.....	893
:SYSTem:COMMunicate:NETWork:REStart.....	893
:SYSTem:COMMunicate:NETWork:STATus?.....	893
:SYSTem:COMMunicate:NETWork[:COMMon]:DOMain.....	893
:SYSTem:COMMunicate:NETWork[:COMMon]:HOSName.....	893
:SYSTem:COMMunicate:NETWork[:COMMon]:WORkgroup.....	894
:SYSTem:COMMunicate:NETWork[:IPADdress]:DNS.....	894
:SYSTem:COMMunicate:NETWork[:IPADdress]:GATeway.....	894
:SYSTem:COMMunicate:NETWork[:IPADdress]:SUBNet:MASK.....	894
:SYSTem:COMMunicate:SERial:BAUD.....	895
:SYSTem:COMMunicate:SERial:PARity.....	895
:SYSTem:COMMunicate:SERial:RESource?.....	895
:SYSTem:COMMunicate:SERial:SBITS.....	895
:SYSTem:COMMunicate:SOCKet:RESource?.....	896
:SYSTem:COMMunicate:USB:RESource?.....	896
:SYSTem:HELP:EXPort.....	896
:SYSTem:IDENtification.....	896
:SYSTem:IDENtification:PRESet.....	897
:SYSTem:IRESpone.....	897
:SYSTem:ORESpone.....	897
:SYSTem:LANGuage.....	898
:SYSTem:INFORmation:SCPI.....	898
:SYSTem:SECurity:SANitize[:STATe].....	898
:SYSTem:SECurity:SUPolicy.....	899
:SYSTem:SPECification?.....	899
:SYSTem:SPECification:VERSIon.....	900
:SYSTem:SPECification:IDENtification:CATalog?.....	900
:SYSTem:SPECification:PARAmeter?.....	901
:SYSTem:SPECification:VERSIon:CATalog?.....	901
:SYSTem:SPECification:VERSIon:FACTory?.....	901
:SYSTem:SRData?.....	902
:SYSTem:STARtup:COMPLete?.....	902
:SYSTem:DATE.....	902
:SYSTem:NTP:HOSTName.....	903
:SYSTem:NTP:STATe.....	903
:SYSTem:TIME.....	903

:SYSTem:TIME:ZONE.....	904
:SYSTem:TIME:ZONE:CATalog?.....	904
:SYSTem:UPTime?.....	904
:SYSTem:BIOS:VERSion?.....	904
:SYSTem:VERSion?.....	904
:SYSTem:OSYStem?.....	905
:SYSTem:MMEMory:PATH:USER?.....	905
:SYSTem:DFPR?.....	905
:SYSTem:REBoot.....	905
:SYSTem:REStart.....	906
:SYSTem:SHUTdown.....	906
:SYSTem:WAIT.....	906
:SYSTem:FILEs:TEMPorary:DELeTe.....	906

:SYSTem:ERRor:ALL?

Queries the error/event queue for all unread items and removes them from the queue. The response is a comma separated list of error number and a short description of the error in FIFO order.

Positive error numbers are instrument-dependent. Negative error numbers are reserved by the SCPI standard.

Return values:

<All> string
 List of: Error/event_number,"Error/event_description">[:Device-dependent info]"
 If the queue is empty, the response is 0, "No error"

Example:

SYST:ERR:ALL?
 queries all entries in the error queue.
 Response: 0, 'no error'
 No errors have occurred since the error queue was last read out.

Usage: Query only

Manual operation: See "[Clear History](#)" on page 942

:SYSTem:ERRor:CODE:ALL?

Queries all entries in the error queue and then deletes them. Only the error numbers are returned and not the entire error text.

Return values:

<All> string
0
 "No error", i.e. the error queue is empty
positive value
 Positive error numbers denote device-specific errors
negative value
 Negative error numbers denote error messages defined by SCPI.

Example:

SYST:ERR:CODE:ALL
 queries all entries in the error queue.
 Response: 0
 no errors have occurred since the error queue was last read out.

Usage:

Query only

:SYSTem:ERRor:CODE[:NEXT]?

Queries the oldest entry in the error queue and then deletes it. Only the error number is returned and not the entire error text.

Return values:

<Next> string
0
 "No error", i.e. the error queue is empty
positive value
 Positive error numbers denote device-specific errors
negative value
 Negative error numbers denote error messages defined by SCPI.

Example:

SYST:ERR:CODE
 queries the oldest entry in the error queue.
 Response: 0
 No errors have occurred since the error queue was last read out.

Usage:

Query only

:SYSTem:ERRor:COUNT?

Queries the number of entries in the error queue. If the error queue is empty, '0' is returned.

Return values:

<Count> integer

Example:

SYST:ERR:COUN
 queries the number of entries in the error queue.
 Response: 1
 One error has occurred since the error queue was last read out.

Usage: Query only

:SYSTem:ERRor[:NEXT]?

Queries the error/event queue for the oldest item and removes it from the queue. The response consists of an error number and a short description of the error.

Positive error numbers are instrument-dependent. Negative error numbers are reserved by the SCPI standard.

Return values:

<Next> string
 Error/event_number,"Error/event_description">[;Device-dependent info]"
 If the queue is empty, the response is 0, "No error"

Example:

```
SYST:ERR?
queries the oldest entry in the error queue.
Response: 0, 'no error'
No errors have occurred since the error queue was last read out.
```

Usage: Query only

Manual operation: See "[Show History / Show Static](#)" on page 942

:SYSTem:ERRor:GNEXt?

Queries the next error from a global persistent error/event queue. The response consists of an error number and a short description of the error.

Positive error numbers are instrument-dependent. Negative error numbers are reserved by the SCPI standard.

Return values:

<NextGlobalError> string
 Error/event number, "Error/event description" > [;Device dependent info]"

Example:

```
SYST:ERR:GNEX?
// Returns the next error message from the persistent error queue.
```

Usage: Query only

Manual operation: See "[Show History / Show Static](#)" on page 942

:SYSTem:ERRor:HISTory?

Queries the error history.

Return values:

<ErrorHistory> string
 Returns all entries of the error queue.
 The result size can reach several kilobytes.

Example: See [Example "Querying the error queue"](#) on page 883.
Usage: Query only

:SYSTem:ERRor:HISTory:CLEar

Clears the error history.

Example: See [Example "Querying the error queue"](#) on page 883

Usage: Event

Manual operation: See ["Clear History"](#) on page 942

:SYSTem:ERRor:STATic?

Returns a list of all errors existing at the time when the query is started. This list corresponds to the display on the info page under manual control.

Return values:

<StaticErrors> string

Example: See [Example "Querying the error queue"](#) on page 883

Usage: Query only

:SYSTem:ULOCK <Mode>

Locks or unlocks the user interface of the instrument.

Parameters:

<Mode> ENABLEd | DONLy | DISabled | TOFF | VNConly

ENABLEd

Unlocks the display, the touchscreen and all controls for the manual operation.

DONLy

Locks the touchscreen and controls for the manual operation of the instrument. The display shows the current settings.

VNConly

Locks the touchscreen and controls for the manual operation, and enables remote operation over VNC. The display shows the current settings.

TOFF

Locks the touchscreen for the manual operation of the instrument. The display shows the current settings.

DISabled

Locks the display, the touchscreen and all controls for the manual operation.

*RST: n.a. (factory preset: ENABLEd)

Example: :SYST:ULOC DIS
 \\ activates the user interface lock, including display and controls.

Manual operation: See "User Interface" on page 511

:SYSTem:DLOCK <DispLockStat>

Disables the manual operation via the display, including the front panel keyboard of the instrument and the Local key.

Parameters:

<DispLockStat> 0 | 1 | OFF | ON
 *RST: n.a. (factory preset: 0)

Example: SYST:DLOC ON
 Activates the display lock. The instrument cannot be operated via the display until it has been enabled with SYST:DLOC OFF.

Manual operation: See "User Interface" on page 511

:SYSTem:KLOCK <State>

Disables the front panel keyboard of the instrument including the Local key.

Parameters:

<State> 0 | 1 | OFF | ON
 *RST: n.a. (factory preset: 0)

Example: SYST:KLOC ON
 Locks the front panel and external controls.
 To enable the controls, send SYST:KLOC OFF.

Manual operation: See "User Interface" on page 511

:SYSTem:SAV <Pathname>

Saves the current instrument settings to a file with defined filename.

Setting parameters:

<Pathname> string

Example: SYSTem:SAV
 "/var/user/Instrument_settings.svrcltxt"

Usage: Setting only

:SYSTem:RCL <Pathname>

Loads a file with previously saved instrument settings.

Setting parameters:

<Pathname> string

Example: SYSTEM:RCL
 "/var/user/Instrument_settings.svrcltxt"

Usage: Setting only

:SYSTEM:PROTECT<ch>[:STATE] <State>[, <Key>]

Activates and deactivates the specified protection level.

Suffix:

<ch> Indicates the protection level.
 See also "[Protection](#)" on page 505

Parameters:

<State> 0 | 1 | OFF | ON
 *RST: n.a. (factory preset: 1)

Setting parameters:

<Key> integer

The respective functions are disabled when the protection level is activated. No password is required for activation of a level. A password must be entered to deactivate the protection level. The default password for the first level is 123456. This protection level is required to unlock internal adjustments for example.

Example: // to activate protection level
 SYSTEM:PROTECT1:STATE 1
 // internal adjustments or hostname cannot be changed
 // to unlock protection level 1
 SYSTEM:PROTECT1:STATE 0,123456
 // internal adjustments are accessible

Manual operation: See "[Protection Level/Password](#)" on page 507

:SYSTEM:SECURITY:VOLMODE[:STATE] <SecPassWord>, <MmemProtState>

Activates volatile mode, so that no user data can be written to the internal memory permanently.

To enable volatile mode, reboot the instrument. Otherwise the change has no effect.

Parameters:

<MmemProtState> 0 | 1 | OFF | ON
 *RST: 0

Setting parameters:

<SecPassWord> string

Current security password
The default password is 123456.

Example: SYSTEM:SECURITY:VOLMODE:STATE "123456", 1
 SYSTEM:REBOOT

Manual operation: See ["Volatile Mode"](#) on page 510

:SYSTem:COMMunicate:GPIB:LTERminator <LTerminator>

Sets the terminator recognition for remote control via GPIB interface.

Parameters:

<LTerminator> STANdard | EOI

EOI

Recognizes an LF (Line Feed) as the terminator only when it is sent with the line message EOI (End of Line). This setting is recommended particularly for binary block transmissions, as binary blocks may coincidentally contain a character with value LF (Line Feed), although it is not determined as a terminator.

STANdard

Recognizes an LF (Line Feed) as the terminator regardless of whether it is sent with or without EOI.

*RST: n.a. (factory preset: STANdard)

Example: See [Example "Finding out the used VISA resource strings"](#) on page 883.

:SYSTem:COMMunicate:GPIB:RESource?

Queries the visa resource string for remote control via the GPIB interface.

To change the GPIB address, use the command `:SYSTem:COMMunicate:GPIB[:SELF]:ADDRes`.

Return values:

<Resource> string

Example: See [Example "Finding out the used VISA resource strings"](#) on page 883.

Usage: Query only

:SYSTem:COMMunicate:GPIB[:SELF]:ADDRes <Address>

Sets the GPIB address.

Parameters:

<Address> integer
 Range: 0 to 30
 *RST: 28

Example: See [Example "Finding out the used VISA resource strings"](#) on page 883.

:SYSTem:COMMunicate:HISLip:RESource?

Queries the VISA resource string . This string is used for remote control of the instrument with HiSLIP protocol.

Return values:

<Resource> string

Example: See [Example "Finding out the used VISA ressource strings"](#) on page 883.

Usage: Query only

:SYSTem:COMMunicate:NETWork:IPADdress <IpAddress>

Sets the IP address.

Parameters:

<IpAddress> string
Range: 0.0.0.0. to ff.ff.ff.ff

Example: See [Example "Retrieving information on network-related settings"](#) on page 882.

Manual operation: See ["IP Address"](#) on page 534

:SYSTem:COMMunicate:NETWork:IPADdress:MODE <Mode>

Selects manual or automatic setting of the IP address.

Parameters:

<Mode> AUTO | STATic
*RST: n.a. (factory preset: AUTO)

Example: See [Example "Retrieving information on network-related settings"](#) on page 882.

Example: `SYSTem:COMMunicate:NETWork:IPADdress:MODE STATic`
`SYSTem:COMMunicate:NETWork:IPADdress "10.113.0.105"`

Manual operation: See ["Address Mode"](#) on page 533

:SYSTem:COMMunicate:NETWork:MACAddress <MacAddress>

Queries the MAC address of the network adapter.

This is a password-protected function. Unlock the protection level 1 to access it, see : [SYSTem:PROTECT<ch>\[:STATe\]](#).

Parameters:

<MacAddress> string

Example: See [Example "Retrieving information on network-related settings"](#) on page 882.

Manual operation: See ["MAC Address"](#) on page 535

:SYSTem:COMMunicate:NETWork:RESource?

Queries the visa resource string for Ethernet instruments.

Return values:

<Resource> string

Example: See [Example "Finding out the used VISA ressource strings"](#) on page 883.

Usage: Query only

:SYSTem:COMMunicate:NETWork:REStart

Restarts the network.

Example:

```
SYSTem:COMMunicate:NETWork:REStart
// Terminates the network connection and sets it up again
```

Usage: Event

Manual operation: See ["Restart Network"](#) on page 533

:SYSTem:COMMunicate:NETWork:STATus?

Queries the network configuration state.

Return values:

<State> 0 | 1 | OFF | ON

Example: See [Example "Retrieving information on network-related settings"](#) on page 882.

Usage: Query only

Manual operation: See ["Network Status"](#) on page 532

:SYSTem:COMMunicate:NETWork[:COMMON]:DOMain <Domain>

Determines the primary suffix of the network domain.

Parameters:

<Domain> string

Example: See [Example "Retrieving information on network-related settings"](#) on page 882.

Manual operation: See ["DNS Suffix"](#) on page 534

:SYSTem:COMMunicate:NETWork[:COMMON]:HOSTname <Hostname>

Sets an individual hostname for the vector signal generator.

Note: We recommend that you do not change the hostname to avoid problems with the network connection. If you change the hostname, be sure to use a unique name.

This is a password-protected function. Unlock the protection level 1 to access it, see : [SYSTem:PROTECT<ch>\[:STATe\]](#).

Parameters:

<Hostname> string

Example: See [Example "Retrieving information on network-related settings"](#) on page 882.

Manual operation: See ["Hostname"](#) on page 533

:SYSTem:COMMunicate:NETWork[:COMMON]:WORKgroup <Workgroup>

Sets an individual workgroup name for the instrument.

Parameters:

<Workgroup> string

Example: See [Example "Retrieving information on network-related settings"](#) on page 882.

Manual operation: See ["Workgroup"](#) on page 533

:SYSTem:COMMunicate:NETWork[:IPAdDress]:DNS <DNS>

Determines or queries the network DNS server to resolve the name.

Parameters:

<DNS> string

Example: See [Example "Retrieving information on network-related settings"](#) on page 882.

Manual operation: See ["DNS Server"](#) on page 534

:SYSTem:COMMunicate:NETWork[:IPAdDress]:GATeway <Gateway>

Sets the IP address of the default gateway.

Parameters:

<Gateway> string

Range: 0.0.0.0 to ff.ff.ff.ff

Example: See [Example "Retrieving information on network-related settings"](#) on page 882.

Manual operation: See ["Default Gateway"](#) on page 534

:SYSTem:COMMunicate:NETWork[:IPAdDress]:SUBNet:MASK <Mask>

Sets the subnet mask.

Parameters:

<Mask> string

Example:

See [Example "Retrieving information on network-related settings"](#) on page 882.

Manual operation: See ["Subnet Mask"](#) on page 534

:SYSTem:COMMunicate:SERial:BAUD <Baud>

Defines the baudrate for the serial remote control interface.

Parameters:

<Baud> 2400 | 4800 | 9600 | 19200 | 38400 | 57600 | 115200

*RST: n.a. (factory preset: 115200)

Example:

See [Example "Finding out the used VISA resource strings"](#) on page 883.

Manual operation: See ["Baud Rate"](#) on page 536

:SYSTem:COMMunicate:SERial:PARity <Parity>

Enters the parity for the serial remote control interface.

Parameters:

<Parity> NONE | ODD | EVEN

*RST: n.a. (factory preset: NONE)

Example:

See [Example "Finding out the used VISA resource strings"](#) on page 883.

Manual operation: See ["Parity"](#) on page 536

:SYSTem:COMMunicate:SERial:RESource?

Queries the visa resource string for the serial remote control interface. This string is used for remote control of the instrument.

Return values:

<Resource> string

Example:

See [Example "Finding out the used VISA resource strings"](#) on page 883.

Usage:

Query only

:SYSTem:COMMunicate:SERial:SBITs <SBits>

Defines the number of stop bits for the serial remote control interface.

Parameters:

<SBits> 1 | 2
 *RST: n.a. (factory preset: 1)

Example: See [Example "Finding out the used VISA resource strings"](#) on page 883.

Manual operation: See ["Stop Bits"](#) on page 537

:SYSTEM:COMMunicate:SOCKet:RESource?

Queries the visa resource string for remote control via LAN interface, using TCP/IP socket protocol.

Return values:

<Resource> string

Example: See [Example "Finding out the used VISA resource strings"](#) on page 883.

Usage: Query only

:SYSTEM:COMMunicate:USB:RESource?

Queries the visa resource string for remote control via the USB interface.

Return values:

<Resource> string

Example: See [Example "Finding out the used VISA resource strings"](#) on page 883.

Usage: Query only

:SYSTEM:HELP:EXPort

Saves the online help as zip archive in the user directory.

Example:

```
:SYSTEM:HELP:EXPort
MMEM:CDIR?
// "/var/user"
MMEM:CAT?
// ..,"Log,DIR,4096","help.tgz,BIN,69836600"
// confirms that help zip archive is saved.
```

Usage: Event

Manual operation:: "Setup > Help > Export Help to User Path"

:SYSTEM:IDENTification <Identification>

Selects the mode to determine the "IDN String" and the "OPT String" for the instrument, selected with command `:SYSTEM:LANGuage`.

Note: While working in an emulation mode, the R&S SMBV100B specific command set is disabled, that is, the SCPI command `SYST:IDEN` is discarded.

Parameters:

<Identification> AUTO | USER

AUTO
Automatically determines the strings.

USER
User-defined strings can be selected.

*RST: n.a. (factory preset: AUTO)

Example:

```
SYST:IDEN AUTO
```

Automatically assigns the OPT and IDN strings according to the selected instrument language.

Manual operation: See "[Mode](#)" on page 537

:SYSTEM:IDENTification:PRESet

Sets the *IDN and *OPT strings in user defined mode to default values.

Example:

```
SYST:IDEN USER
SYST:IDEN:PRES
```

Usage: Event

Manual operation: See "[Set to Default](#)" on page 538

:SYSTEM:IRESpOse <IdnResponse>

Defines the user defined identification string for *IDN.

Note: While working in an emulation mode, the instrument's specific command set is disabled, i.e. the SCPI command `SYST:IRES` is discarded.

Parameters:

<IdnResponse> string

Example:

```
SYST:IDEN USER
// Selects a user-defined identification
SYST:IRES "Test Device"
// Defines the identification string 'test device'
*IDN?
// Response: 'test device'
```

Manual operation: See "[IDN String](#)" on page 538

:SYSTEM:ORESpOse <OResponse>

Defines the user defined response string for *OPT.

Note: While working in an emulation mode, the instrument's specific command set is disabled, i.e. the SCPI command `SYST:ORES` is discarded.

Parameters:**<OResponse>** string**Example:**

```

SYST:IDEN USER
// Selects a user-defined identification
SYST:ORES "Test Option"
// Defines the OPT string 'test option'
*OPT?
// Response: 'test option'

```

Manual operation: See "[OPT String](#)" on page 538**:SYSTem:LANGUage <Language>**

Sets the remote control command set.

Parameters:**<Language>** string**Example:**

```

SYSTem:LANGUage "SCPI"
// selects SCPI command set

```

Manual operation: See "[Language](#)" on page 537**:SYSTem:INFormation:SCPI <InfoString>**

Inserts system information in recorded SCPI command lists, for example information on a missing command.

Parameters:**<InfoString>** string**Example:**

```

SYST:INF:SCPI "missing command"
enters the information into a recorded SCPI command list.

```

:SYSTem:SECurity:SANitize[:STATe] <SecPassWord>, <MmemProtState>

Sanitizes the internal memory.

Parameters:

<MmemProtState> 0 | 1 | OFF | ON
***RST:** 0

Setting parameters:**<SecPassWord>** string**Example:**

```

SYSTem:SECurity:SANitize[:STATe] 1
//

```

Manual operation: See "[Sanitize](#)" on page 510

:SYSTem:SECurity:SUPolicy <SecPassWord>, <Update Policy>

Configures the automatic signature verification for firmware installation.

Parameters:

<Update Policy> STRict | CONFirm | IGNore
*RST: n.a. (factory preset: CONFirm)

Setting parameters:

<SecPassWord> string

Manual operation: See "[Secure Update Policy](#)" on page 508

:SYSTem:SPECification? <Id>

Retrieves data sheet information for a specific parameter.

Setting parameters:

<Id> string
Identifies the name of the entry in the data sheet, as queried with the command `:SYSTem:SPECification:IDENTification:CATalog?` on page 900

Return values:

<ValList> float
Comma-separated list with the specified and, if available, the typical value of the parameter, as specified in the data sheet. See also "[Data Sheet](#)" on page 546.

Example:

Retrieving instruments specification

Note: The following values are merely an example.

```
// query the data sheet versions stored in the instrument
:SYSTEM:SPECification:VERSion:CATalog?
// "04.03,04.02,04.01,04.00,03.04,03.03,03.02,03.01,03.00,
// 02.96,02.95,02.94,02.02,02.01,02.00,01.03,01.02,01.01,01.00"

// query the data sheet version with that the instrument was delivered
:SYSTEM:SPECification:VERSion:FACTory?
// "04.00"

// select a data sheet version
:SYSTEM:SPECification:VERSion?
// 04.00
:SYSTEM:SPECification:VERSion "04.01"
// selects one particular data sheet version
// queries regarding data sheet parameters (IDs) and their values
// refer to this particular data sheet

// query the IDs of all parameters
// listed in the selected data sheet version
:SYSTEM:SPECification:IDENtification:CATalog?
// "ID_RF_FREQ_SETTING_TIME_ALC_ON_MS,ID_RF_FREQ_SETTING_TIME_MS,..."

// query the data sheet information on a specific parameter,
// defined by its ID
:SYSTEM:SPECification? "ID_RF_FREQ_SETTING_TIME_ALC_ON_MS"
// returned is the specified and, if available,
// the typical value of the parameter
```

Usage:

Query only

:SYSTEM:SPECification:VERSion <Version>

Selects a data sheet version from the data sheets saved on the instrument.

Further queries regarding the data sheet parameters (<Id>) and their values refer to the selected data sheet.

To query the list of data sheet versions, use the command `:SYSTEM:SPECification:VERSion:CATalog?` on page 901.**Parameters:**

<Version> string

Example: See `:SYSTEM:SPECification?` on page 899.**:SYSTEM:SPECification:IDENtification:CATalog?**

Queries the parameter identifiers (<Id>) available in the data sheet.

Return values:

<IdList> string
Comma-separated string of the parameter identifiers (<Id>)

Example: See [:SYSTem:SPECification?](#) on page 899.

Usage: Query only

:SYSTem:SPECification:PARAmeter? <Id>[, <Parameter>]

Retrieves data sheet information for a specific parameter.

Setting parameters:

<Id> string
Identifies the name of the entry in the data sheet.
Query the data sheet parameters with the command [:SYSTem:SPECification:IDENTification:CATalog?](#).

<Parameter> float
An additional value the result (ValList) depends on.

Return values:

<ValList> float
Comma-separated list with the specified and, if available, the typical value of the parameter, as specified in the data sheet.

Example: **Note:** The following values are merely an example. Your instrument may not support the same parameters.

```
SYST:SPEC:PAR? "ID_RF_FREQ_SETTING_TIME_MS",0.1
SYST:SPEC:PAR? "ID_RF_LEVEL_MAX_GENERAL_DBM",
0.1
```

Usage: Query only

:SYSTem:SPECification:VERSion:CATalog?

Queries all data sheet versions stored in the instrument.

Return values:

<VersCatalog> string

Example: See [:SYSTem:SPECification?](#) on page 899.

Usage: Query only

:SYSTem:SPECification:VERSion:FACTory?

Queries the data sheet version of the factory setting.

Return values:

<Version> string

Example: See [:SYSTem:SPECification?](#) on page 899.

Usage: Query only
Manual operation: See "Versions" on page 937

:SYSTEM:SRData?

Queries the SCPI recording data from the internal file.

This feature enables you to transfer an instrument configuration to other test environments, as e.g. laboratory virtual instruments.

Return values:

<FileData> block data

Example:

```
SYSTEM:SRData?
// #3118:SOURce1:ROSCillator:SOURce EXT
// :SOURce1:FREQuency:CW 4000000000
// :SOURce1:FREQuency:OFFSet 1000000
// :SOURce1:AM1:STATe 1
// :OUTPut1:STATe 1
```

Usage: Query only

:SYSTEM:STARtup:COMPLete?

Queries if the startup of the instrument is completed.

Return values:

<Complete> 0 | 1 | OFF | ON
 *RST: 0

Example:

```
SYST:STAR:COMP?
Response: 1
the startup of the instrument is completed.
```

Usage: Query only

:SYSTEM:DATE <Year>, <Month>, <Day>

Queries or sets the date for the instrument-internal calendar.

This is a password-protected function. Unlock the protection level 1 to access it, see : [SYSTEM:PROTECT<ch>\[:STATe\]](#).

Parameters:

<Year> integer
 <Month> integer
 Range: 1 to 12
 <Day> integer
 Range: 1 to 31

Example: :SYSTem:DATE?
 // 2016,05,01

Manual operation: See ["Date"](#) on page 923

:SYSTem:NTP:HOSTname <NTPName>

Sets the address of the NTP server. You can enter the IP address, or the hostname.

Parameters:
<NTPName> string

Example: SYSTem:NTP:HOSTname "pool.ntp.org"

Manual operation: See ["NTP Address"](#) on page 923

:SYSTem:NTP:STATe <UseNtpState>

Activates clock synchronization via NTP.

Parameters:
<UseNtpState> 0 | 1 | OFF | ON
*RST: n.a. (factory preset: 0)

Example: SYSTem:NTP:STATe 1

Manual operation: See ["Use Time from NTP Server"](#) on page 924

:SYSTem:TIME <Hour>, <Minute>, <Second>

Queries or sets the time for the instrument-internal clock.

This is a password-protected function. Unlock the protection level 1 to access it, see : [SYSTem:PROTeCt<ch>\[:STATe\]](#).

Parameters:
<Hour> integer
 Range: 0 to 23

<Minute> integer
 Range: 0 to 59

<Second> integer
 Range: 0 to 59

Example: SYSTem:TIME?
 // 10,27,14

Manual operation: See ["Time"](#) on page 923

:SYSTEM:TIME:ZONE <TimeZone>

Sets the timezone. You can query the list of the available timezones with **:SYSTEM:TIME:ZONE:CATalog?**.

Parameters:

<TimeZone> string

Manual operation: See "Timezone" on page 923

:SYSTEM:TIME:ZONE:CATalog?

Queries the list of available timezones.

Return values:

<Catalog>

Usage: Query only

Manual operation: See "Timezone" on page 923

:SYSTEM:UPTime?

Queries the up time of the operating system.

Return values:

<UpTime> "<ddd.hh:mm:ss>"

Example:

SYSTEM:UPTime?

Response: "0.08:11:00"

Usage: Query only

:SYSTEM:BIOS:VERSion?

Queries the BIOS version of the instrument.

Return values:

<Version> string

Example:

SYST:BIOS:VERS?

queries the BIOS version.

Response: 123456

Usage: Query only

:SYSTEM:VERSion?

Queries the SCPI version the instrument's command set complies with.

Return values:

<Version> string

Example: `SYST:VERS`
 queries the SCPI version.
 Response: "1996"
 The instrument complies with the SCPI version from 1996.

Usage: Query only

:SYSTem:OSYStem?

Queries the operating system of the instrument.

Return values:

<OperSystem> string

Example: `SYSTem:OSYStem?`
 Response: "Linux"

Usage: Query only

:SYSTem:MMEMory:PATH:USER?

Queries the user directory, that means the directory the R&S SMBV100B stores user files on.

Return values:

<PathUser> string

Example: `SYSTem:MMEMory:PATH:USER?`
 Response: "/var/user/"

Usage: Query only

:SYSTem:DFPR?

Queries the device footprint of the instrument. The retrieved information is in machine-readable form suitable for automatic further processing.

Return values:

<DeviceFootprint> string

Information on the instrument type and details on the installed FW version, hardware and software options.

Example: `:SYSTem:DFPR?`

Usage: Query only

:SYSTem:REBoot

Reboots the instrument including the operating system.

Usage: Event

:SYSTem:REStart

Restarts the instrument without restarting the operating system.

Usage: Event

:SYSTem:SHUTdown

Shuts down the instrument.

Usage: Event

Manual operation: See "Shut down" on page 933

:SYSTem:WAIT <TimeMs>

Delays the execution of the subsequent remote command by the specified time.

This function is useful, for example to execute an SCPI sequence automatically but with a defined time delay between some commands.

See [Chapter 10.3.3, "Assigning Actions to the \[★ \(User\)\] Key"](#), on page 500.

Setting parameters:

<TimeMs> integer
Wait time in ms
Range: 0 to 10000
*RST: 0

Example:

```
:SYSTem:WAIT 10000
// waits 10s before resetting the instrument
*RST
```

Usage: Setting only

:SYSTem:FILEs:TEMPorary:DELeTe

Deletes the temporary files from the internal memory or, if installed, from the Non-Volatile Memory.

Example:

```
:SYSTem:FILEs:TEMPorary:DELeTe
// temporary files are removed
```

Usage: Event

12.18 STATus Subsystem

This system contains the commands for the status reporting system. See also [Chapter A.1.5, "Status Reporting System"](#), on page 958 for detailed information.

*RST on page 583 has no effect on the status registers.

Value ranges

- Queries return the current value of the respective register, which permits a check of the device status.
Return values: A decimal value in the range 0 to 32767 ($=2^{15}-1$)
- The configuration commands set the respective register thus determining which status changes of the R&S SMBV100B cause the status registers to be changed.
Setting values: A decimal value in the range 0 to 32767 ($=2^{15}-1$)

:STATus:OPERation:CONDition?	907
:STATus:OPERation:ENABle	907
:STATus:OPERation[:EVENT]	908
:STATus:OPERation:NTRansition	908
:STATus:OPERation:PTRansition	908
:STATus:PRESet	908
:STATus:QUEStionable:CONDition	909
:STATus:QUEStionable:ENABle	909
:STATus:QUEStionable[:EVENT]	909
:STATus:QUEStionable:NTRansition	909
:STATus:QUEStionable:PTRansition	910
:STATus:QUEue[:NEXT]?	910

:STATus:OPERation:CONDition?

Queries the content of the CONDition part of the STATus:OPERation register.

This part contains information on the action currently being performed in the instrument. The content is not deleted after being read out because it indicates the current hardware status.

Return values:

<Condition> string

Example: :STATus:OPERation:CONDition?

Usage: Query only

:STATus:OPERation:ENABle <Enable>

Sets the bits of the ENABle part of the STATus:OPERation register. This setting determines which events of the Status-Event part are forwarded to the sum bit in the status byte. These events can be used for a service request.

Parameters:

<Enable> string

Example: :STAT:OPER:ENAB 32767
all events are forwarded to the sum bit of the status byte.

:STATus:OPERation[:EVENT] <Event>

Queries the content of the EVENT part of the STATus:OPERation register. This part contains information on the actions performed in the instrument since the last readout. The content of the EVENT part is deleted after being read out.

Parameters:

<Event> string

Example:

:STAT:OPER:EVEN?

queries the STATus:OPERation:EVENT register.

:STATus:OPERation:NTRansition <Ntransition>

Sets the bits of the NTRansition part of the STATus:OPERation register. If a bit is set, a transition from 1 to 0 in the condition part causes an entry to be made in the EVENT part of the register. The disappearance of an event in the hardware is thus registered, for example the end of an adjustment.

Parameters:

<Ntransition> string

Example:

:STAT:OPER:NTR 0

a transition from 1 to 0 in the condition part of the Status:Operation register does not cause an entry to be made in the EVENT part.

:STATus:OPERation:PTRansition <Ptransition>

Sets the bits of the PTRansition part of the STATus:OPERation register. If a bit is set, a transition from 0 to 1 in the condition part causes an entry to be made in the EVENT part of the register. A new event in the hardware is thus registered, for example the start of an adjustment.

Parameters:

<Ptransition> string

Example:

:STAT:OPER:PTR 32767

all transitions from 0 to 1 in the condition part of the Status:Operation register cause an entry to be made in the EVENT part.

:STATus:PRESet <Preset>

Resets the status registers. All PTRansition parts are set to FFFFh (32767), i.e. all transitions from 0 to 1 are detected. All NTRansition parts are set to 0, i.e. a transition from 1 to 0 in a CONDITION bit is not detected. The ENABLE parts of STATus:OPERation and STATus:QUESTionable are set to 0, i.e. all events in these registers are not passed on.

Parameters:

<Preset> string

Example: STAT:PRES
resets the status registers.

:STATus:QUEStionable:CONDition <Condition>

Queries the content of the CONDition part of the STATus:QUEStionable register. This part contains information on the action currently being performed in the instrument. The content is not deleted after being read out since it indicates the current hardware status.

Parameters:
<Condition> string

Example: :STATus:QUEStionable:CONDition?
queries the Status:Questionable:Condition register.

:STATus:QUEStionable:ENABle <Enable>

Sets the bits of the ENABle part of the STATus:QUEStionable register. The enable part determines which events of the STATus:EVENT part are enabled for the summary bit in the status byte. These events can be used for a service request.

If a bit in the ENABle part is 1, and the corresponding EVENT bit is true, a positive transition occurs in the summary bit. This transition is reported to the next higher level.

Parameters:
<Enable> string

Example: STAT:QUES:ENAB 1
Problems when performing an adjustment cause an entry to be made in the sum bit.

:STATus:QUEStionable[:EVENT] <Event>

Queries the content of the EVENT part of the STATus:QUEStionable register. This part contains information on the actions performed in the instrument since the last readout. The content of the EVENT part is deleted after being read out.

Parameters:
<Event> string

Example: STAT:QUES:EVENT?
queries the Status:Questionable:Event register.

:STATus:QUEStionable:NTRansition <Ntransition>

Sets the bits of the NTRansition part of the STATus:QUEStionable register. If a bit is set, a transition from 1 to 0 in the condition part causes an entry to be made in the EVENT part of the register.

Parameters:
<Ntransition> string

Example: `STAT:QUES:NTR 0`
 a transition from 1 to 0 in the condition part of the STATus:QUEStionable register does not cause an entry to be made in the EVENT part

:STATus:QUEStionable:PTRansition <PTransition>

Sets the bits of the NTRansition part of the STATus:QUEStionable register. If a bit is set, a transition from 1 to 0 in the condition part causes an entry to be made in the EVENT part of the register.

Parameters:

<PTransition> string

Example: `STAT:QUES:PTR 32767`
 all transitions from 0 to 1 in the condition part of the STATus:QUEStionable register cause an entry to be made in the EVENT part

:STATus:QUEue[:NEXT]?

Queries the oldest entry in the error queue and then deletes it. Positive error numbers denote device-specific errors, and negative error numbers denote error messages defined by SCPI. If the error queue is empty, 0 ("No error") is returned.

The command is identical to `:SYSTem:ERRor[:NEXT]?` on page 887.

Return values:

<Next> string

Example: `:STATus:QUEue?`
 queries the oldest entry in the error queue.
 Response: 0, 'no error'
 no errors have occurred since the error queue was last read out

Usage: Query only

12.19 TEST Subsystem

The TEST subsystem contains the commands for performing test routines directly at the hardware assemblies.

The selftest responses with a 0 if the test is performed successfully, otherwise a value other than 0 is returned. None of the commands of this system has a *RST value.

<code>:TEST:BASEband?</code>	911
<code>:TEST:BB:BNC:CONNection?</code>	911
<code>:TEST:BB:BNC:SOURce</code>	911
<code>:TEST:BB:BNC:DEStination</code>	912
<code>:TEST:BB:BNC:LOG?</code>	912
<code>:TEST:BB:BNC:SOURce</code>	912

:TEST:BB:GENerator:ARBitrary.....	913
:TEST:BB:GENerator:FREQuency.....	913
:TEST:BB:GENerator:GAIN.....	913
:TEST:BB:GENerator:SOURce.....	914
:TEST:BB:GENerator:STATe.....	914
:TEST<hw>:ALL:START.....	914
:TEST<hw>:ALL:RESUlt?.....	914

:TEST:BASEband?

Queries the result of the baseband selftest.

Return values:

<TestBbError> 0 | 1 | RUNning | STOPped

Example:

```
:TEST:BASEband?
// 0
// the test succeeded
```

Usage: Query only

Manual operation: See "Execute Baseband Selftest" on page 930

:TEST:BB:BNC:CONNection?

Queries the BNC connection test result.

This is a password-protected function. Unlock the protection level 1 to access it, see : [SYSTem:PROTeCt<ch>\[:STATe\]](#).

Return values:

<TestStatus> 0 | 1 | RUNning | STOPped

Example:

```
SYSTem:PROTeCt1 0,123456
TEST:BB:BNC:CONNection?
// RUN
// test is running
```

Usage: Query only

Manual operation: See "Execute BNC Connection Test" on page 929

:TEST:BB:BNC:SOURce <BncSource>

Selects the BNC connection test source.

This is a password-protected function. Unlock the protection level 1 to access it, see : [SYSTem:PROTeCt<ch>\[:STATe\]](#).

Parameters:

<BncSource> AUTO | USER1 | USER2 | USER3 | USER4 | USER5
*RST: USER1

Example:

```

SYSTEM:PROTECT1 0,123456
TEST:BB:BNC:SOURCE AUTO
// detects the connectors at that signal is assigned
// and performs the connecton test

```

Manual operation: See "[Source](#)" on page 929

:TEST:BB:BNC:DESTINATION <BncDestination>

Selects the BNC connection test destination.

This is a password-protected function. Unlock the protection level 1 to access it, see : [SYSTEM:PROTECT<ch>\[:STATE\]](#).

Parameters:

<BncDestination> AUTO | USER1 | USER2 | USER3 | USER4 | USER5
 *RST: USER2

Example:

```

SYSTEM:PROTECT1 0,123456
TEST:BB:BNC:DESTINATION USER1

```

Manual operation: See "[Destination](#)" on page 929

:TEST:BB:BNC:LOG?

Queries the log message reported during the BNC connector test.

This is a password-protected function. Unlock the protection level 1 to access it, see : [SYSTEM:PROTECT<ch>\[:STATE\]](#).

Return values:

<Log> string

Example:

```

SYSTEM:PROTECT1 0,123456
TEST:BB:BNC:LOG?
// queries the reported message

```

Usage: Query only

Manual operation: See "[Log Message](#)" on page 930

:TEST:BB:BNC:SOURCE <BncSource>

Selects the BNC connection test source.

This is a password-protected function. Unlock the protection level 1 to access it, see : [SYSTEM:PROTECT<ch>\[:STATE\]](#).

Parameters:

<BncSource> AUTO | USER1 | USER2 | USER3 | USER4 | USER5 | USER6 |
 TRGA | TRGB | C1TMC1 | C1TM2 | C1TM3 | C2TMC4 |
 C2TM5 | C2TM6 | F1TMC1 | F1TM2 | F1TM3 | F2TMC4 |
 F2TM5 | F2TM6 | F3TMC1 | F3TM2 | F3TM3 | F4TMC4 |
 F4TM5 | F4TM6
 *RST: USER1

Example:

```
SYSTem:PROTeCt1 0,123456
TEST:BB:BNC:SOURce AUTO
// detects the connectors at that signal is assigned
// and performs the connecton test
```

:TEST:BB:GENerator:ARBitrary <Filename>

Selects the ARB waveform to be tested.

Parameters:

<Filename> string

Example:

```
TEST:BB:GENerator:ARBitrary "3gpp.wv"
// Tests the loaded waveform, generating a 3GPP signal
```

Manual operation: See "[Select ARB File](#)" on page 932

:TEST:BB:GENerator:FREQuency <Frequency>

Sets the frequency of the test sine or constant I/Q test signal.

Parameters:

<Frequency> float
 Range: -250E6 to 250E6
 Increment: 1E-3
 *RST: 1E6

Example:

```
TEST:BB:GENerator:FREQuency 50 MHz
```

Manual operation: See "[Frequency](#)" on page 931

:TEST:BB:GENerator:GAIN <Gain>

Sets the gain for a sine or constant I/Q test signal.

Parameters:

<Gain> float
 Range: -1 to 1
 Increment: 1E-6
 *RST: 1

Example:

```
TEST:BB:GENerator:GAIN 0.5
// amplifies the test signal by a factor of 0.5
```

Manual operation: See "[Gain](#)" on page 931

:TEST:BB:GENerator:SOURce <lqSource>

Selects the test signal source.

Parameters:

<lqSource> SINE | CONStant | ARB

SINE

Generates a sine waveform. To determine the frequency, use command `:TEST:BB:GENerator:FREQuency` on page 913.

CONStant

Uses a constant I/Q test signal.

ARB

Selects a signal generated generated by the ARB.

*RST: SINE

Example: `:TEST:BB:GENerator:SOURce SINE`

Manual operation: See "[IQ Source](#)" on page 931

:TEST:BB:GENerator:STATe <State>

Starts the test generator.

Parameters:

<State> 0 | 1 | OFF | ON

*RST: 0

Example: `TEST:BB:GENerator:STATe ON`
`// activates the test generator`

Manual operation: See "[State](#)" on page 931

:TEST<hw>:ALL:START

Usage: Event

Starts the selftest. Use the command `:TEST<hw>:ALL:RESult?` to query the result.

:TEST<hw>:ALL:RESult?

Queries the result of the performed selftest. Start the selftest with `:TEST<hw>:ALL:START`.

Return values:

<Result> 0 | 1 | RUNning | STOPped

*RST: STOPped

Usage: Query only

12.20 TRIGger Subsystem

The TRIGger system contains the commands for selecting the trigger source for the RF and LF sweep.

You can work with an internal or with an externally applied trigger signal. In this case, use the commands in the SOURce:INPut subsystem to configure the signal.

The trigger system of the R&S SMBV100B is a simplified implementation of the SCPI trigger system. The TRIGger system differs from the SCPI system as follows:

- No INITiate command; the instrument behaves as if INITiate:CONTinuous ON were set.
- Under TRIGger several sweep subsystems exist.
- The trigger source names correspond directly to the various settings of manual control. SCPI uses different names which are also accepted by the instrument. The SCPI names should be used if compatibility is an important consideration.

In addition to these commands, see more trigger-related commands in the modulation and RF signal subsystems.

Table 12-5: Cross-reference between the manual and remote control

R&S proprietary value name	SCPI conform value name	Parameter in manual control
AUTO	IMMediate	"Auto" mode
SINGLE	BUS	"Single" mode.
EXTernal	EXTernal	"Ext Single" and "Ext Step" mode. Use command LFO:SWEEP:MODE to select between the two sweep modes.
EAuto	-	"Ext Start/Stop" mode.

:TRIGger<hw>:FSweep:SOURce.....	915
:TRIGger<hw>:LFFSweep:SOURce.....	915
:TRIGger<hw>:PSweep:SOURce.....	915
:TRIGger<hw>[:SWEep]:SOURce.....	915
:TRIGger<hw>:FSweep[:IMMediate].....	917
:TRIGger<hw>:PSweep[:IMMediate].....	917
:TRIGger<hw>:LFFSweep:IMMediate.....	917
:TRIGger<hw>[:SWEep][:IMMediate].....	917
:TRIGger<hw>:LFFSweep.....	917

```

:TRIGger<hw>:FSweep:SOURce <Source>
:TRIGger<hw>:LFFSweep:SOURce <Source>
:TRIGger<hw>:PSweep:SOURce <Source>
:TRIGger<hw>[:SWEep]:SOURce <Source>

```

Selects the trigger source for the corresponding sweeps:

- FSweep - RF frequency
- LFFSweep - LF frequency

- PSweep - RF level
- SWEEP - all sweeps

The source names of the parameters correspond to the values provided in manual control of the instrument. They differ from the SCPI-compliant names, but the instrument accepts both variants.

Use the SCPI name, if compatibility is an important issue. Find the corresponding SCPI-compliant commands in [Cross-reference between the manual and remote control](#).

Setting parameters:

<Source> AUTO | IMMEDIATE | SINGLE | BUS | EXTERNAL | EAUTO

AUTO [IMMEDIATE]
Executes a sweep automatically.
In this free-running mode, the trigger condition is met continuously. I.e. when a sweep is completed, the next one starts immediately.

SINGLE [BUS]
Executes one complete sweep cycle.
The following commands initiate a trigger event:
*TRG on page 584
[:SOURce<hw>]:SWEep:POWer:EXECute
[:SOURce<hw>]:SWEep[:FREQuency]:EXECute
:TRIGger<hw>[:SWEep][:IMMEDIATE], :TRIGger<hw>:
PSWep[:IMMEDIATE] and :TRIGger<hw>:FSWep[:
IMMEDIATE].

Set the sweep mode with the commands:
[:SOURce<hw>]:SWEep:POWer:MODE AUTO | STEP
[:SOURce<hw>]:SWEep[:FREQuency]:MODE AUTO | STEP
[:SOURce<hw>]:LFOutput:SWEep[:FREQuency]:MODE
AUTO | STEP

In step mode (STEP), the instrument executes only one step.

EXTERNAL
An external signal triggers the sweep.

EAUTO
An external signal triggers the sweep. When one sweep is finished, the next sweep starts.
A second trigger event stops the sweep at the current frequency, a third trigger event starts the trigger at the start frequency, and so on.

*RST: AUTO

Example: See [Example "Setup an LF sweep"](#) on page 829

Usage: Setting only

Manual operation: See ["Mode"](#) on page 302

```
:TRIGger<hw>:FSweep[:IMMEDIATE]
:TRIGger<hw>:PSweep[:IMMEDIATE]
:TRIGger<hw>:LFFSweep:IMMEDIATE
:TRIGger<hw>[:SWEep][:IMMEDIATE]
```

Performs a single sweep and immediately starts the activated, corresponding sweep:

- FSweep - RF frequency
- PSweep - RF level
- LFFSweep - LF frequency
- SWEep - all sweeps

Effective in the following configuration:

- TRIG:FSW|LFFS|PSW|[:SWE]:SOUR **SING**
- SOUR:SWE:FREQ|POW:MODE **AUTO** or SOUR:LFO:SWE:[FREQ:]MODE **AUTO**

Alternatively, you can use the IMMEDIATE command instead of the respective SWEep:[FREQ:]|POW:EXECute command.

Example: TRIG
Starts all active sweeps.

Usage: Event

Manual operation: See "Execute Single Sweep" on page 305

```
:TRIGger<hw>:LFFSweep
```

Executes an LF frequency sweep in the following configuration:

- TRIG:LFFS:SOUR **SING**
- LFO:SWE:MODE **AUTO**

Example: LFO:SWE:MODE AUTO
TRIG:LFFS:SOUR SING
TRIG:LFFSweep

Usage: Event

12.21 UNIT Subsystem

The UNIT subsystem is used to set default units for parameters if no unit is indicated in a command. These settings are valid for the entire instrument.

Example: Setting default units for remote control

```
UNIT:POW V
UNIT:ANGL DEG
```

Sets V (volts) as unit of all power parameters, DEG (degrees) for the phase modulation angle and KMH for the speed.

:UNIT:ANGLE.....	918
:UNIT:POWer.....	918
:UNIT:VELOCITY.....	918

:UNIT:ANGLE <Angle>

Sets the default unit for phase modulation angle. The command affects no other parameters, such as RF phase, or the manual control or display.

Parameters:

<Angle> DEGree | DEGRee | RADian
 *RST: RADian

:UNIT:POWer <Power>

Sets the default unit for all power parameters. This setting affects the GUI, as well as all remote control commands that determine power values.

Parameters:

<Power> V | DBUV | DBM
 *RST: DBM

:UNIT:VELOCITY <Velocity>

Sets the default unit for the velocity of the wave.

Parameters:

<Velocity> MPS | KMH | MPH | NMPH
 *RST: MPS

13 Maintenance

The instrument does not need periodic maintenance. Only the cleaning of the instrument is essential.

Follow the instructions in the service manual and the safety instructions when exchanging modules or ordering spares. The order no. for spare parts is included in the service manual. The service manual includes further information particularly on troubleshooting, repair, exchange of modules and alignment.

The address of our support center and a list of all Rohde & Schwarz service centers can be found at the beginning of this manual.

NOTICE

Risk of damage during shipment

Insufficient protection against mechanical and electrostatic effects during shipment can damage the instrument.

- When shipping an instrument, use the original packaging. If you do not have the original packaging, use sufficient padding to prevent the instrument from moving around inside the box.
 - Pack the instrument in antistatic wrap to protect it from electrostatic charging.
 - Secure the instrument to prevent any movement and other mechanical effects during transportation.
-

13.1 Cleaning

WARNING

Risk of electric shock

If moisture enters the casing, for example if you clean the instrument using a moist cloth, contact with the instrument can lead to electric shock. Before cleaning the instrument other than with a dry cloth, make sure that the instrument is switched off and disconnected from all power supplies.

NOTICE**Instrument damage caused by cleaning agents**

Cleaning agents contain substances such as solvents (thinners, acetone, etc.), acids, bases, or other substances. Solvents can damage the front panel labeling, plastic parts, or screens, for example.

Never use cleaning agents to clean the outside of the instrument. Use a soft, dry, lint-free dust cloth instead.

NOTICE**Risk of instrument damage due to obstructed fans**

If the instrument is operated in dusty areas, the fans become obstructed by dust or other particles over time. Check and clean the fans regularly to ensure that they always operate properly. If the instrument is run with obstructed fans for a longer period, the instrument overheats, which can disturb the operation and even cause damage.

1. Clean the outside of the instrument using a soft, dry, lint-free dust cloth.
2. Check and clean the fans regularly to ensure that they always operate properly.
3. Clean the touchscreen as follows:
 - a) Apply a small amount of standard screen cleaner to a soft cloth.
 - b) Wipe the screen gently with the moist, but not wet, cloth.
 - c) If necessary, remove any excess moisture with a dry, soft cloth.

13.2 Storing and Packing

The storage temperature range of the instrument is given in the data sheet. If the instrument is to be stored for a longer period of time, it must be protected against dust.

Repack the instrument as it was originally packed when transporting or shipping. The two protective foam plastic parts prevent the control elements and connectors from being damaged. The antistatic packing foil avoids any undesired electrostatic charging to occur.

If you do not use the original packaging, use a sturdy cardboard box of suitable size and provide for sufficient padding to prevent the instrument from slipping inside the package. Wrap antistatic packing foil around the instrument to protect it from electrostatic charging.

13.3 Performing Maintenance Tasks

The R&S SMBV100B is accurate due to integrated adjustment procedures, which you can execute directly on the instrument.

Internal Adjustments

NOTICE

Risk of invalid adjustment

Wait until the instrument has reached its operating temperature before you start the adjustment procedure. The warm-up time is 30 minutes.



Self-calibration routines that require additional (external) equipment are performed at an authorized Rohde & Schwarz service center.

See also "[Protection levels](#)" on page 505.

When to perform adjustments?

We recommend that you perform internal adjustments in the following cases:

- Before starting any application, that requires a maximum of level and frequency accuracy
- When a long period of time has passed since the last adjustments
- If the ambient temperature of the instrument significantly differs from the one of the last adjustments

Additional Information to the Adjustments

During adjustments, a progress indicator shows the status of the process. If any error occurs, the process aborts and an error message appears in the info line.

The extent of the adjustments depends on the installed options.

Performing Selftests

The available selftests check internally various functions of the instrument. We recommend that you perform a selftest, if the instrument does not respond as expected.

The accessible selftests are divided in:

- Testing baseband and BNC connections, see [Chapter 13.3.4, "Selftest Connections Settings"](#), on page 928
- Testing the baseband domain, see [Chapter 13.3.5, "Selftest Baseband Settings"](#), on page 930
- Test generator, see [Chapter 13.3.6, "Selftest Test Generator Settings \(DAC\)"](#), on page 930

13.3.1 Date and Time Settings

The R&S SMBV100B uses an internal real-time clock to determine the date and time. It adjusts the time and date to the timezone of your location automatically, by providing a selection list of continents and cities.

The instrument records the time whenever you create or modify files on your instrument or you use timed licenses. By default, the instrument is set to the UTC timezone, but you can select the timezone according to your location.

Moreover, the instrument supports [NTP](#) protocol for synchronizing all connected instruments and computer systems to minimize time delays in the network.

Access:

- ▶ Select "System Config > Setup > Maintenance > Date / Time".

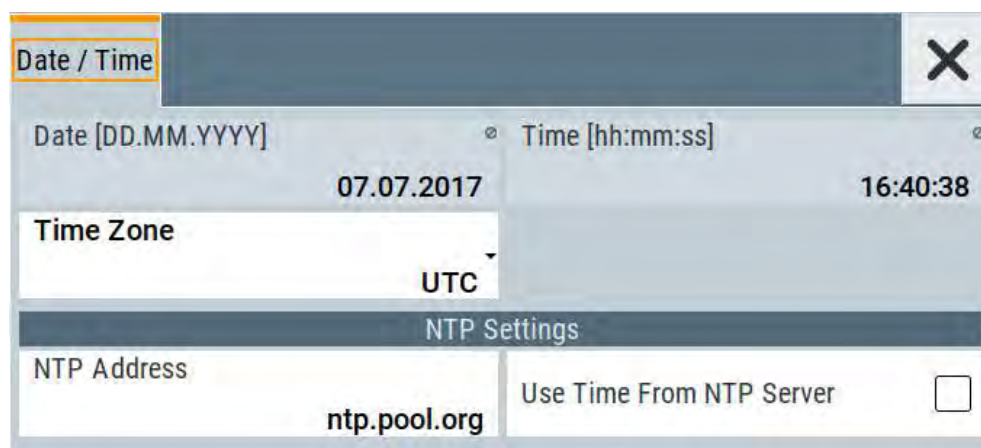

The "Date / Time" dialog contains the time and data settings of the operating system.

This function is password-protected. Unlock the protection level 1 to access it.

The required remote commands are described in [Chapter 12.17, "SYSTEM Subsystem"](#), on page 882.

To select the timezone

1. Press the [Setup] key.
2. Select "Maintenance > Date /Time > Timezone".
3. Select continent and city of your location.
Tip: By typing the first letter, you can quickly navigate through the lists to find the desired destination.
4. Close the dialogs.

The instrument adjusts the time according to the selected location.

To set the date and time

1. Press the [Setup] key.
2. Select "Security > Protection".
3. Enable the "Protection Level 1".
The default password is 123456.
4. Select "Setup > Maintenance > Date / Time".
5. Adjust the settings.
6. Close the dialogs.

The instrument adopts the new date and time.

Settings:

Date.....	923
Time.....	923
Timezone.....	923
NTP Address.....	923
Use Time from NTP Server.....	924

Date

Displays the date set in the operating system in the format [dd.mm.yyyy].

Remote command:

:SYSTem:DATE on page 902

Time

Displays the time set in the operating system in the format [hh.mm.ss].

The time setting corresponds to the selected [Use Time from NTP Server](#).

Remote command:

:SYSTem:TIME on page 903

Timezone

Selects the timezone.

You can select the timezone according to the major cities on the respective continents.

Note: By typing the first letter, you can quickly navigate through the lists to find the desired destination.

Remote command:

:SYSTem:TIME:ZONE on page 904

:SYSTem:TIME:ZONE:CATalog? on page 904

NTP Address

Sets the IP address or host name of the NTP server.

NTP is a network time protocol used for synchronizing all participating devices in a data network.

You can select a high-precision time server to reduce the impact of varying network delays.

Remote command:

:SYSTem:NTP:HOSTname on page 903

Use Time from NTP Server

Activates clock synchronization of the network via the NTP protocol.

Remote command:

:SYSTem:NTP:STATe on page 903

13.3.2 Check Front Panel

Within this dialog, you can verify the functionality of the control keys.

For Instructions on how to perform the tests and the expected results, see [Chapter 13.3.2.2, "How to Test the Front Panel"](#), on page 925

In case of malfunctions:

Contact the Rohde & Schwarz customer support, see [Chapter 14.6, "Collecting Information for Technical Support"](#), on page 944.



Accessing the online help in the check front panel dialog or exiting via [Esc]

During the test, the actual functions of all keys are disabled, including the [Help] and the [Esc] keys.

13.3.2.1 Check Front Panel Settings

Access:

- ▶ Select "System Config > Setup > Maintenance > Check Front Panel".



Reflecting the front panel, the "Check Front Panel" dialog contains all functions to test the operating elements of the instrument.

In addition, you can check the touch-sensitive functionality by dragging one or more lines across the screen with your finger.

Touchscreen Test

Enables you to perform a touchscreen test. This test checks whether the touchscreen area has gaps in the response.

See ["How to perform the touchscreen test"](#) on page 926

13.3.2.2 How to Test the Front Panel

How to perform the key panel test

To perform the key panel test, you operate the keys at the front panel, and check the response of the instrument in the "Check Front Panel" dialog. To perform this test properly, check each key of the front panel. The test is only completed, when you have verified all keys.

During the test, the actual functions of the keys are disabled.

1. Press the [Setup] key.
2. Select "Maintenance > Check Front Panel"
The "Check Front Panel" dialog opens.
3. Press a key on the front panel.
Check if the corresponding key in the "Check Front Panel" dialog turns green.
4. Press the same key a second time.
Check that the key in the dialog turns red.
Note: Pressing the same key again has no further effect, except for the [Esc] key, see [Press the ESC key a third time](#).
5. Continue with the next key on the front panel and repeat [step 3](#) to [step 5](#) until all keys are tested.

The test is completed, when each key is verified successfully, confirmed by a "Test passed" message.

▶ Press the [Esc] key a third time.
Exits the "Check Front Panel" dialog.

Expected responses:

- Pressing a key once (green), pressing twice (red)
- Pressing the [Esc] key a third time exits the dialog.

If you detect a malfunction, for example, you press the front panel key the first time, and the color of the button in the dialog turns red (instead of green), the front panel key may be stuck.

Contact the Rohde & Schwarz customer support, see [Chapter 14.6, "Collecting Information for Technical Support"](#), on page 944.

How to perform the touchscreen test

1. Press the [Setup] key.
2. Select "Maintenance > Check Touch Panel"
The "Finger Paint" test window opens.

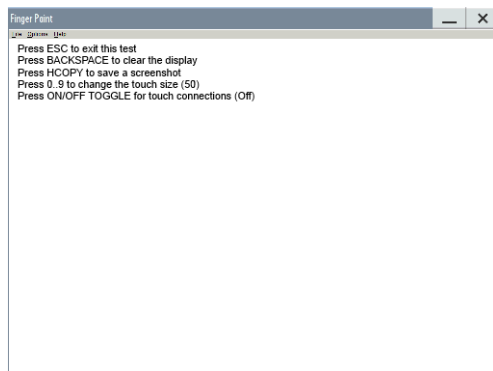

3. Drag with your finger one or more lines, for example diagonally across the screen.
The test traces the movements of your finger on the screen.

The following results are expected:

- If the lines are uninterrupted, the touchscreen works properly.

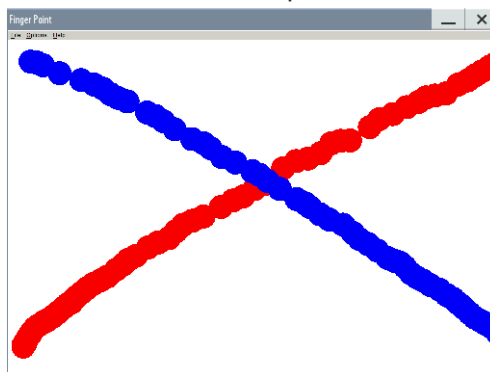

- If there are any gaps, the touch-sensitive functionality is damaged.

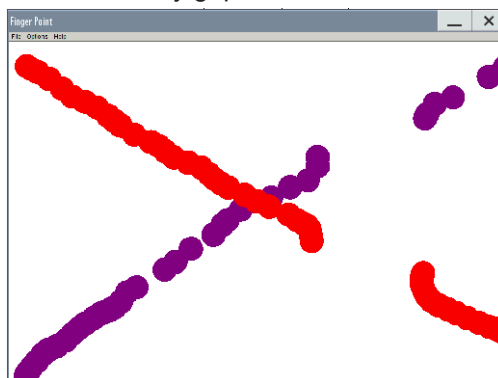

- To return to the "Check Front Panel" dialog, press [Esc].

If there are malfunctions:

Contact the Rohde & Schwarz customer support, see [Chapter 14.6, "Collecting Information for Technical Support"](#), on page 944.

13.3.3 Internal Adjustment Settings

Access:

- ▶ Select "System Config > Setup > General > Internal Adjustments".

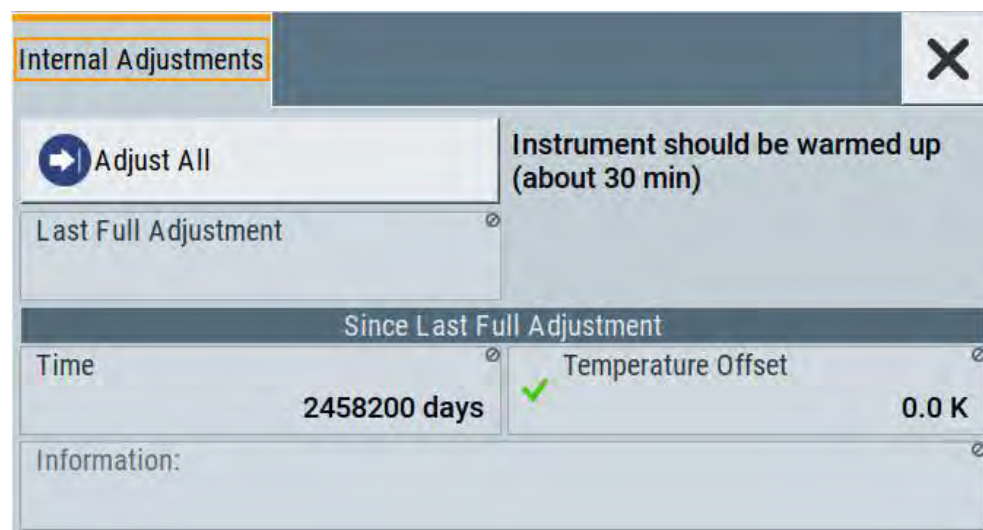

In this dialog, you can perform internal calibration routines and get information on the last performed calibration.

The remote commands required to define these settings are described in [Chapter 12.7, "CALibration Subsystem"](#), on page 599.



The background color of "Temperature Offset" depends on the deviation of the temperature at the beginning of the adjustment, compared to the last adjustment. We recommend that you perform internal adjustments if the instrument is warmed up, but depending on instrument usage, less than 30 minutes are sufficient.

Further functions and individually targeted calibration routines are also available but password-protected.

- Calibration routines
Self-calibration routines that require additional (external) equipment are performed in the Rohde & Schwarz service center. These functions are password-protected and require higher-level protection password, see ["Protection levels"](#) on page 505

For more information, see R&S SMBV100B Service Manual.

Adjust All

Performs all available internal calibration routines of the instrument.

Remote command:

`:CALibration:ALL[:MEASure]?` on page 599

Last Full Adjustment

Displays the date of the last fully performed adjustment.

Remote command:

`:CALibration<hw>:ALL:DATE?` on page 600

Time Since Last Full Adjustment

Displays the elapsed time since the last full adjustment.

Remote command:

`:CALibration<hw>:ALL:TIME?` on page 601

Temperature Offset Since Last Full Adjustment

Displays the temperature difference, comparing the temperature at the beginning of the last adjustment to the temperature at the beginning of the present adjustment.

If the temperature deviates more than ± 5 K, the background of the parameter turns yellow.

Remote command:

`:CALibration<hw>:ALL:TEMP?` on page 600

Information

Displays information to the current adjustment state.

Remote command:

`:CALibration<hw>:ALL:INformation?` on page 600

13.3.4 Selftest Connections Settings

Access:

- Select "System Config > Setup > Maintenance > Selftest > Connections".

Connections	Baseband	DAC
Execute Baseband Connections Test ---		
BNC Connections Test		
Source	USER 1 (Front) ▾	
Destination	USER 2 (Front) ▾	
Execute BNC Connections Test ---		
Log Message: ○		

The "Connections" dialog contains the parameters for testing the signal flow at the connectors.

The remote commands required to define these settings are described in [Chapter 12.19, "TEST Subsystem"](#), on page 910.

How to set up the instrument for BNC connections tests

1. This function is password-protected. Unlock the protection level 1 to access it.
2. Select "System Config > Setup > Maintenance > Selftest > Connections".
3. Select the BNC **Source** (signal output).
4. Select the BNC **Destination** (signal input).
5. On the instrument, connect the selected "Source" connector with the "Destination" connector.
The selection list in the dialog shows you where to find the associated connector on the instrument.
6. Select "Execute BNC Connections Test".

Execute Baseband Connections Test

Performs a connection test on each of the internal digital baseband links.

The test implies to all installed options as baseband inputs, motherboard, universal coding generators, and baseband outputs.

The result (succeeded or failed) is displayed in the status field on the right.

Remote command:

n.a.

BNC Connections Test

This function is password-protected. Unlock the protection level 1 to access it.

Source ← BNC Connections Test

Selects the BNC connector source to be tested.

Remote command:

`:TEST:BB:BNC:SOURce` on page 911

Destination ← BNC Connections Test

Selects the BNC connector destination to be tested.

Remote command:

`:TEST:BB:BNC:DESTination` on page 912

Execute BNC Connection Test ← BNC Connections Test

Performs the BNC connection test at the selected connectors.

Remote command:

`:TEST:BB:BNC:CONNECTION?` on page 911

Log Message ← BNC Connections Test

Displays the log message reported during the BNC connections test.

Remote command:

:[TEST:BB:BNC:LOG?](#) on page 912

13.3.5 Selftest Baseband Settings

Access:

- ▶ Select "System Config > Setup > Maintenance > Selftest > Baseband".

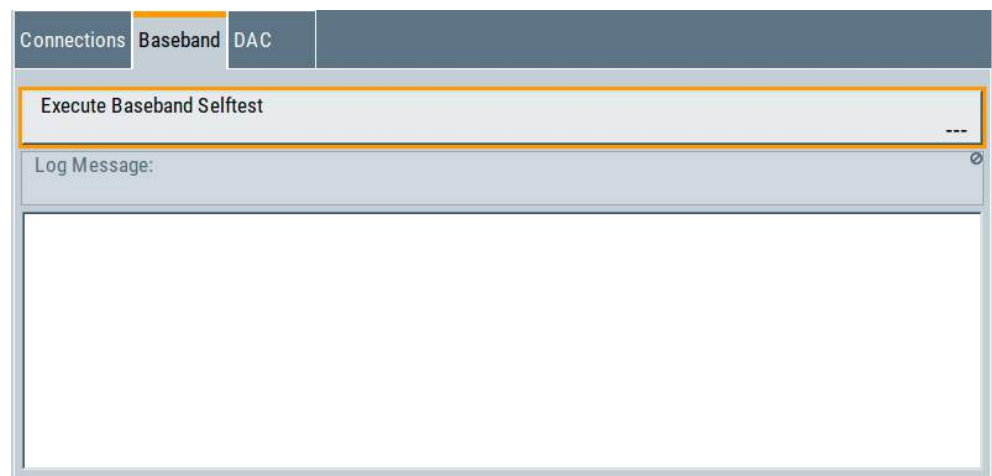

In the "Baseband" dialog you can execute the baseband selftest.

The remote command required to start the test is described in [Chapter 12.19, "TEST Subsystem"](#), on page 910.

Execute Baseband Selftest

Performs a baseband selftest.

The result (succeeded or failed) is displayed in the status field on the right.

Remote command:

:[TEST:BASeband?](#) on page 911

Log Message

Displays the log message reported during the baseband test.

Remote command:

n.a.

13.3.6 Selftest Test Generator Settings (DAC)

This function is password-protected. Unlock the protection level 1 to access it.

Access:

- ▶ Select "System Config > Setup > Maintenance > Selftest > DAC".

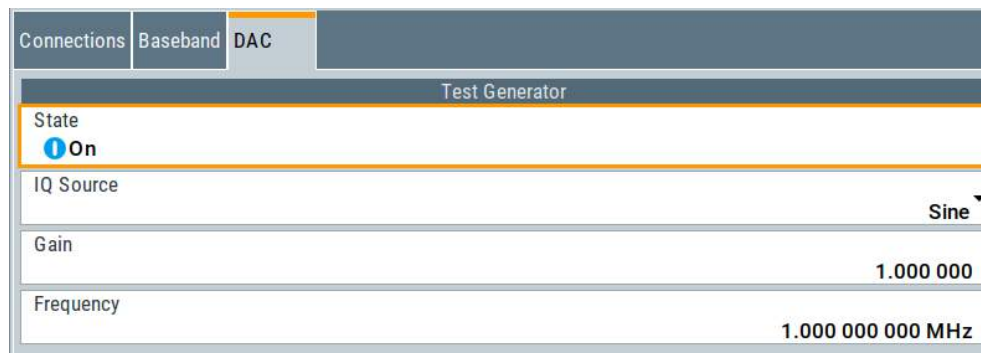

The "DAC" dialog contains the parameters for testing the IQ signal source.

The remote commands required to define these settings are described in [Chapter 12.19, "TEST Subsystem"](#), on page 910.

State

Starts the test generator.

Remote command:

`:TEST:BB:GENerator:STATe` on page 914

IQ Source

Selects the test signal source.

"Sine" Generates a sine waveform with frequency as set with the parameter [Frequency](#).

"Constant I/Q" Uses a constant I/Q test signal. For more details, see [Chapter 3.6.3.4, "Constant IQ Test Signal"](#), on page 157.

"ARB" Selects a signal generated by the ARB. Select the waveform file with the parameter [Select ARB File](#).

Remote command:

`:TEST:BB:GENerator:SOURce` on page 914

Gain

Sets the gain for a sine or a constant I/Q test signal.

Remote command:

`:TEST:BB:GENerator:GAIN` on page 913

Frequency

If "IQ Source = Sine", sets the frequency of the test signal.

Remote command:

`:TEST:BB:GENerator:FREQuency` on page 913

Select ARB File

Provides access to the standard "File Select" function of the instrument. The provided navigation possibilities in the dialog are self-explanatory.

See also, chapter "File and Data Management" in the R&S SMBV100B User Manual.

Remote command:

:TEST:BB:GENerator:ARbitrary on page 913

13.3.7 FPGA/uC Update Settings

Access:

- ▶ Select "System Config > Setup > Maintenance > FPGA/μC Update".

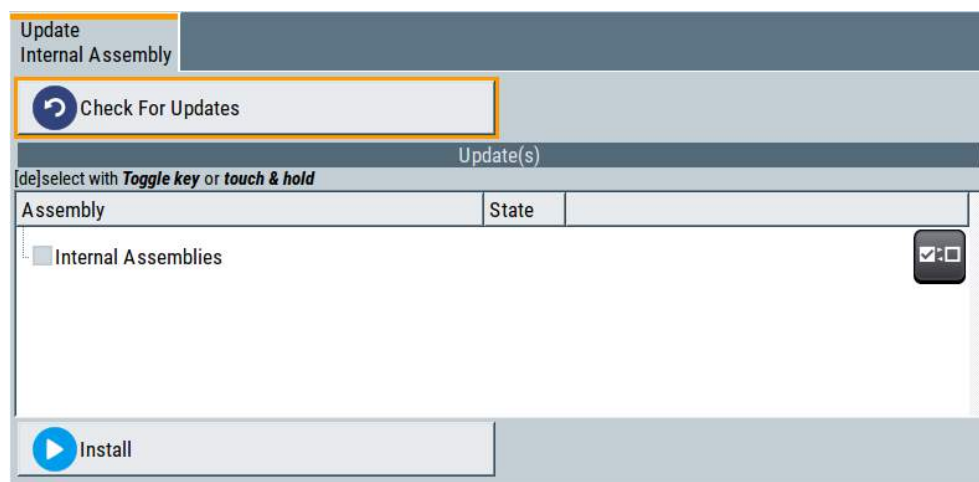

This dialog enables you to check for and install internal assembly updates.

Settings:

Check For Updates.....	932
Assembly.....	932
Install.....	933
Shut down.....	933

Check For Updates

Check for updates of the FPGA/μC.

Remote command:

n.a.

Assembly

The table shows the installed assemblies and their states.

"Assembly" Assembly designation.

"State" Indicates the current state of installed assemblies.

Install

Install all available updates for the FPGA/μC.

Remote command:

n.a.

Shut down

For at least one assembly "State = Done" and no pending assemblies, shuts the instrument down to apply installed updates.

Remote command:

:SYSTem:SHUTdown on page 906

13.3.8 Delete Temporary Files

During signal processing, the R&S SMBV100B creates and stores different temporary files, such as the waveform files (*.wv) of all ARB standards. The instrument stores these temporary files on a predefined directory on its internal memory and, if available, on the Non-Volatile Memory. This predefined directory is a protected system directory that is not accessible via the "File Manager" but you can delete all temporary files stored there.

To achieve more free disc space on the internal memory

1. Select "System Config > Setup > Maintenance > Delete Temporary Files".

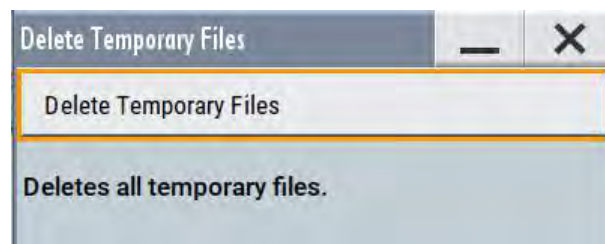

2. Select "Delete Temporary Files".

The content of the predefined directory is deleted.



Another way to achieve more free disc space on the internal memory is to use the [Execute Factory Preset](#).

This function removes all temporary files, too, but also resets several parameters to their factory preset values.

Remote command:

:SYSTem:FILEs:TEMPorary:DElete on page 906

13.3.9 Requesting Instrument Configuration and Specifications

The R&S SMBV100B is equipped with various hardware and software components. To get an overview of what your instrument is equipped with, you can request the assemblies, hardware and software options, and the firmware version. The components are structured according to the hardware configuration, software options, including the license management, and externally used Rohde & Schwarz equipment, like R&S NRP power sensors.



Software options purchased at a later stage can be activated with a keycode. The activation code is supplied with the software option. How to install options is described in chapter 4 of the R&S SMBV100B service manual.

The installation of hardware options purchased at a later stage is also described in chapter 4 of the service manual. Most of the hardware options have to be installed at an authorized Rohde & Schwarz service center.

13.3.9.1 Hardware Configuration Settings

Access:

- ▶ Select "System Config > Setup > Instrument Assembly > Hardware Config".

General	RF Assembly	Baseband Assembly	Counter	
Assembly	Part Number	Serial Number	Revision	Slot
SMBV100B	1423.1003k02	0		
FRONT.BV	1423.6105.02	100000	01.00	PCI-E slot
MB300	1422.4750.02	100000	01.00	PCI-E slot
PSU300	2118.2067.01	100000	01.00	Not detected, but inserted
IFB.BV	1422.4550.02	100000	01.00	
GPIB-FPGA			01.00	
IPM24	1206.3116.00	100000	01.00	PCI-E slot
BIOS				

The "Hardware Config" dialog lists all installed assemblies and externally connected instruments with information on their part and serial numbers, and revision states. The BIOS version is also listed; firmware updates do not update the BIOS version.

The dialog is divided in tabs, according to the hardware components of the signal domains. The "Counter" tab provides information on the operation time and number of times the instrument was powered on.

The remote commands required to query the hardware configuration are described in [Chapter 12.8, "DIAGnostic Subsystem"](#), on page 603.

Assembly

The tables in the tabs show characteristics of the installed assemblies.

"Assembly"	Assembly designation.
"Part Number"	Part number of the assembly.
"Serial Number"	Serial number of the assembly.
"Revision"	Revision state of the assembly.
"Slot"	Indicates whether the assembly is connected to the serial bus or PCI bus.

Remote command:

[:DIAGnostic<hw>:BGInfo?](#) on page 604

Counter

Displays information on the operation times of the R&S SMBV100B.

Operation Time / h ← Counter

Displays the operation time in hours.

Remote command:

n.a.

Power On Count ← Counter

Displays the number of power-on.

Remote command:

n.a.

Last Factory Calibration ← Counter

Displays the date of the last factory calibration.

Remote command:

[:CALibration:DATA:FACTory:DATE?](#) on page 601

13.3.9.2 Versions/Options Settings

Access:

- ▶ Select "System Config > Setup > Instrument Assembly > Versions / Options".

Firmware	Hardware Options	Software Options	Versions
Package	Version		
FW	4.20.044		
Service Pack	not installed		
Bios Version	VirtualBox		
Downgrade Info:			
Package	Version		
Factory Version	4.20.044		
Min. Version	4.00.016.00		
The Min. Version is the first version supporting all hardware modules installed in this instrument. Please read release notes carefully before downgrading, some software options and features may get lost.			
<input type="button" value="Show Open Source Acknowledgements"/>			

The "Versions/Options" dialog shows the version of the installed instrument firmware, the hardware and software options, the data sheet and the software components of the firmware. The BIOS version is also listed; firmware updates do not update the BIOS version.

The remote commands required to query the hardware configuration are described in [Chapter 12.8, "DIAGnostic Subsystem"](#), on page 603.

Firmware

Shows the firmware version and the version of the software platform.

Note: Your instrument is delivered with the latest firmware version available. You can download firmware updates and the "Release Notes" that describe the modifications and the firmware update procedure.

See www.rohde-schwarz.com/firmware/smbv100b

Remote command:

n.a.

Downgrade Info

Shows downgrade information, like factory firmware version and minimum firmware version to that the instrument can be downgraded.

Remote command:

n.a.

Show Open Source Acknowledgments

Accesses the list of the used open source software packages and the corresponding verbatim license texts.

Hardware Options/Software Options

The tables in the "Hardware" and "Software" tabs list the installed hardware and software options.

"Option" Short name of option

"Designation" Name of option

"Expiration Date"

For regular options, "Permanent" is indicated in this column. Some options are available as trial versions. This column shows their expiration date. After this date, the option is no longer available on the instrument.

Remote command:

*[OPT?](#) on page 582

*[IDN?](#) on page 582

Versions

The "Versions" tab shows the versions of the technical specification of the R&S SMBV100B and of the software components that comprise the firmware.

"Package" Name of the component.

"Version" Current issue of the component.
E.g. the data sheet covers the technical data of the hardware components of the factory settings.
See also "[Data Sheet](#)" on page 546.

Remote command:

:[SYSTEM:SPECification:VERSion:FACTory?](#) on page 901

13.3.9.3 Requesting the Data Sheet

You can access data sheet related information via the LXI web browser, see "[Data Sheet](#)" on page 546.

14 Troubleshooting and Error Messages

The R&S SMBV100B distinguishes between various messages such as status messages, error messages, warnings, or information that are displayed in the "Info" line on the screen, and also entered in the error/event queue of the status reporting system.

This section describes the types of error messages and warnings. The status reporting system is described in detail in [Chapter A.1.5, "Status Reporting System"](#), on page 958.

You can also access an Info window with detailed information about all messages in a history list. For details, see [Chapter 14.4, "Querying Error Messages & Info Key"](#), on page 941

14.1 Error Messages

Error messages indicate errors in the instrument. They are displayed in different colors depending on their importance and display duration. Errors (e.g. no calibration data) are displayed in red, information (e.g. file not found) and warnings in black. Warnings indicate less significant errors (e.g. the instrument operates outside specified data).

Some error messages require that the error must be eliminated before correct instrument operation can be ensured. To access the "Info" dialog with a list of current messages and a detailed description of each message, select "Info".

In the remote control mode, error messages are entered in the error/event queue of the status reporting system and can be queried with the command `SYSTem:ERRor?`. If the error queue is empty, 0 ("No error") is returned.

14.1.1 Volatile Messages

Volatile messages report automatic settings in the instrument (e.g. switching off of incompatible types of modulation) or on illegal entries that are not accepted by the instrument (e.g. range violations). They are displayed in the info line on a yellow background. They are displayed on top of status information or permanent messages.

Volatile messages do not normally demand user actions and disappear automatically after a brief period of time. They are stored in the history, however.

SCPI command: `:SYSTem:ERRor:ALL?` or `:SYSTem:ERRor:CODE[:NEXT]?`

14.1.2 Permanent Messages

Permanent messages are displayed if an error occurs that impairs further instrument operation, e.g. a hardware fault. The error signaled by a permanent message must be eliminated before correct instrument operation can be continued.

The message is displayed until the error is eliminated. It covers the status display in the info line. After error elimination, the message automatically disappears and is also recorded in the history.

SCPI command: `:SYSTem:ERRor:STATic?`

14.2 SCPI-Error Messages

The SCPI error messages are the same in all SCPI instruments. Detailed information and an overview of all error messages as defined in SCPI standard can be found in the corresponding documentation.

The errors are assigned negative numbers. The error text being entered into the error/event queue or being displayed is printed in bold face on the left together with the error code. Below the error text, there is an explanation as to the respective error.

14.3 Device-Specific Error Messages

The following table contains all error messages specific for the instrument in alphabetical order, as well as an explanation of the error situation. The positive error codes mark the errors specific to the instrument.

The device-specific error messages set bit 3 in the ESR register.



The index provides a list of the error messages sorted according to their error codes.

Error Code	Error	Description	Remedy
50	Extern reference out of range or disconnected	External reference is selected but no external signal is applied or the signal is out of range.	<ul style="list-style-type: none"> Check the selected reference signal source (internal or external) in the "Setup > Reference Oscillator" dialog. Change setting to 'internal' if no appropriate external source is available.
140	This modulation forces other modulations off	<p>A modulation has been switched on which cannot be used at the same time as an already active modulation. The previous modulation has been switched off.</p> <p>Example: Enabling modulation GSM/EDGE switches any active digital modulation off.</p>	
180	Adjustment failed	Adjustment could not be executed	The adjustment data have to be generated first by an internal or to be loaded into the device

Error Code	Error	Description	Remedy
182	Adjustment data missing	Adjustment data is missing.	The adjustment data has to be generated first by an internal or to be loaded into the instrument.
183	Adjustment data invalid	Adjustment data is invalid and must be restored.	The adjustment data has to be generated again by an internal or to be loaded into the instrument.
200	Cannot access hardware	The data transmission to a module was unsuccessful.	The module is not installed, not properly installed or missing.
201	Hardware revision out of date	A later version of certain parts of the instrument is necessary to execute the function selected.	The driver does not support the installed version of a module.
202	Cannot access the EEPROM	An error occurs when writing or reading a EEPROM.	The EEPROM might be defect and has to be replaced.
203	Invalid EEPROM data	Reading a EEPROM is possible, however the data are inconsistent.	
204	Driver initialization failed	Initialization of a driver fails when booting the instrument firmware.	The driver is not compatible with the hardware or software configuration of the instrument.
241	No current list	There is no list selected. To execute the required operation, a list has to be selected in the related dialog. If no list is available, a new list must be created.	
242	Unknown list type specified	The list type selected is not valid for the required operation. For instance, the file extension for waveform list files is *.wv. It is not possible to enter another file extension when selecting a list.	Check the selected list type.
261	Waveform Protected	The selected waveform file cannot be transferred to a controller. The waveform is produced with simulation software R&S WinIQSIM2 and is protected.	
460	Cannot open file	The selected file cannot be opened.	Check the path and file name.
461	Cannot write file	The file cannot be written.	Check if the file is read-only.
462	Cannot read file	The file cannot be read.	Check if the file contents are compatible with the file type.
463	Filename missing	The required operation cannot be executed because the file name is not specified.	Enter file name when creating list.

Error Code	Error	Description	Remedy
464	Invalid filename extension	The file extension is not valid for the required operation.	Check the file extension. For instance, the file extension for waveform list files is *.wv. It is not possible to enter another file extension when storing a list.
465	File contains invalid data	The selected file contains data that is not valid for the file type. The file extension determines the data that is valid for this file type. If the file extension is changed, the lists are no longer recognized and the data is therefore invalid. Example: the extension of a waveform file (= *.wv) was changed to *.txt	Check the file extension.

14.4 Querying Error Messages & Info Key

The R&S SMBV100B monitors the functions performed and automatically detects errors and irregularities. The instrument displays the messages in the info-line and records them in the background with a detailed description.

Find details to the system messages in [Chapter 14, "Troubleshooting and Error Messages"](#), on page 938.

To display information on static errors and error history

1. In the taskbar, select the "System Config > Info".
2. For some messages, the information line appears briefly on the block diagram.

To open the dialog, select the "Info" button.

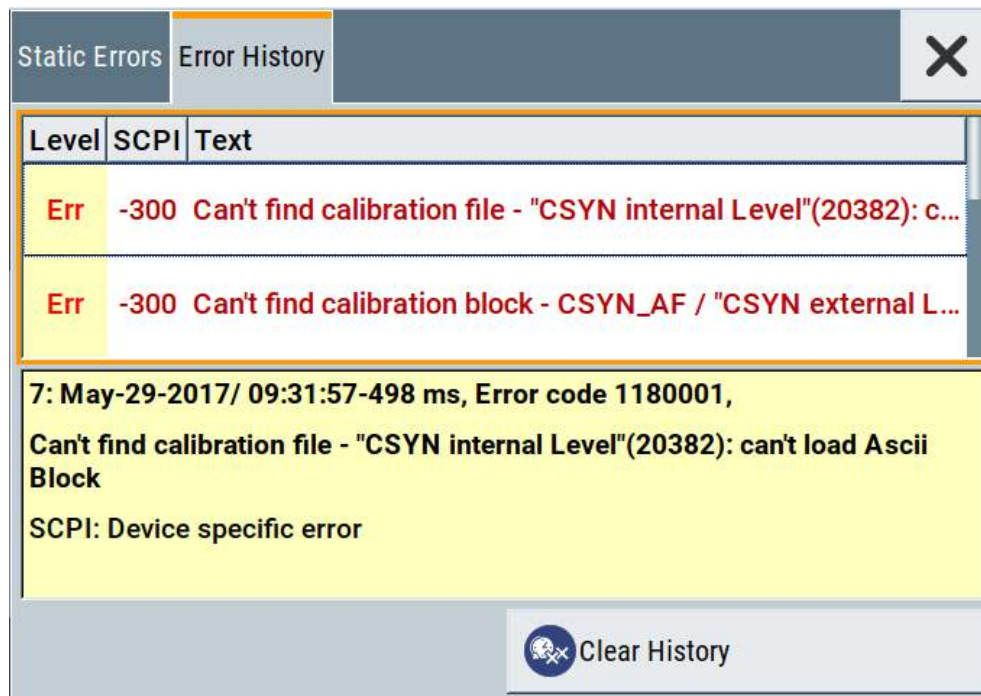

The "Static Errors" dialog lists the last monitored messages chronologically and displays additional information on the highlighted message.

In "Error History" dialog lists all accumulated messages with a short description.



If any critical error occurs, the R&S SMBV100B automatically shows the icon in the taskbar. Select the icon to obtain information on the error and the number of occurrences.

The icon is assigned to permanent messages. The message and icon are displayed until the error is eliminated.

Clear History

Clears all messages in the "History" view.

Remote command:

`:SYSTem:ERRor:ALL?` on page 885

Each time a `SYST:ERR:ALL?` query is sent, the error queue is returned and at the same time cleared.

`:SYSTem:ERRor:HISTory:CLear` on page 888

Clears the messages in the "History" view.

Show History / Show Static

Toggles between "History" and "Static" view of the info dialog.

Remote command:

`:SYSTem:ERRor[:NEXT]?` on page 887

Each time a `SYST:ERR?` query is sent, the oldest entry in the error queue is returned and at the same time cleared in the list.

:SYSTem:ERRor:GNEXt? on page 887

Queries the next entry from the global persistent error queue. The entries are not deleted.

14.5 Resolving Network Connection Failures

Several issues may cause failures in the network connection to the instrument. This section lists the most likely reasons and the recommended solutions.

Common reasons for network connection failures

- Network connecting cables and cable connectors of poor quality
- Incompatibility between the network interface of the R&S SMBV100B and certain switches or routers available on the market
- An invalid IP address assigned to the instrument

Possible solutions

NOTICE

Risk of network failure

Consult your network administrator before performing the following tasks:

- Connecting the instrument to the network
- Configuring the network
- Changing IP addresses

Errors can affect the entire network.

-
- Check the network infrastructure. Exchange connecting cables if obvious damage is visible.
 - Observe the link status LED on the R&S SMBV100B or the connected network device. The link status LED is located next to the LAN connector. If a link failure is detected, connect the instrument to a different device port or to a different network device.
 - Check whether the LAN interface and the required LAN services are enabled. See [Chapter 10.5.3, "Configuring LAN Services"](#), on page 513.
 - Check whether the IP address of the instrument is within the network's address range.
(See also ["IP Address"](#) on page 534).
Check whether IP addresses that were set manually or obtained via the Zeroconf (APIPA) protocol are valid.

14.6 Collecting Information for Technical Support

If you encounter problems that you cannot solve yourself, contact your Rohde & Schwarz support center as listed at <http://www.customersupport.rohde-schwarz.com>. Our support center staff is optimally trained to assist you in solving problems.

The support center finds solutions more quickly and efficiently if you provide them with information on the instrument and an error description.

- The following dialog boxes in the "Setup > Instrument Assembly" menu provide useful information:
 - **Hardware Configuration:** hardware assemblies
 - **Software and Options:** the status of all software and hardware options installed on your instrument
- **System Messages:** displayed in the "Info" line and provide information on any errors that have occurred
- **Support file:** a special file (*.tar.gz file) with important support information that can be created automatically.
The support *.tar.gz file has a user definable name and contains the following files and information:
 - SgErrors.txt: chronological record of errors
 - SystemRestorationSMBV100B.savrc1.txt: instrument settings at the last correct shutdown of the instrument
 - UndoHistSuppInfo.xml: list of the last user interactions
 - DeviceFootprint_<SerialNumber>_<Date>_<Time>.xml: service-related information on the instrument's configuration.
 - crashlog.txt, coredump: Postmortem debug info
 - Several files with information on the last performed adjustment and self-test.

See also the description of error messages [Chapter 14.1, "Error Messages"](#), on page 938.

To collect error information in a support file

1. Connect a USB device to the R&S SMBV100B.
2. Select "System Config > Setup > Maintenance > Create R&S Support Information".
3. In the "Create R&S Support Information" dialog, navigate to the /usb directory. Enter the support filename, for example RSupport_DeviceInfo.

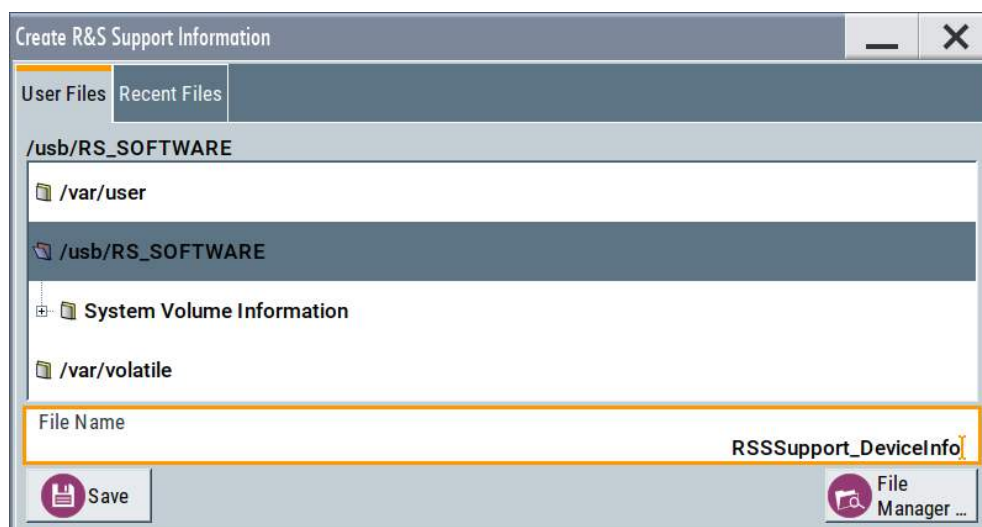

The error information and further required data is collected automatically.

The support file `RSSupport_DeviceInfo.tar.gz` is created and stored in the `/usb` directory.

Collect the error information and attach it to an email in which you describe the problem. Send the email to the customer support address for your region as listed on the Internet (<http://www.customersupport.rohde-schwarz.com>).

To remove sensitive data

- ▶ For information on how to handle or remove the sensitive data from your instrument, refer to the description "Resolving Security Issues when working with R&S SMBV100B".

Packing and transporting the instrument

- ▶ If the instrument has to be transported or shipped, observe the notes described in [Chapter 2.1.1.2, "Unpacking and Checking the Instrument"](#), on page 29.

Annex

A Reference Information for Remote Control

A.1 Additional Basics on Remote Control

This section provides basic information using the remote control.

A.1.1 Messages

The messages transferred on the data lines are divided into the following categories:

- **Interface messages**
Interface messages are transmitted to the instrument on the data lines, with the attention line being active (LOW). They are used to communicate between the controller and the instrument. Interface messages can only be sent by instruments that have GPIB bus functionality. For details see the sections for the required interface.
- **Instrument messages**
Instrument messages are employed in the same way for all interfaces, if not indicated otherwise in the description. Structure and syntax of the instrument messages are described in [Chapter A.1.3, "SCPI Command Structure"](#), on page 947. A detailed description of all messages available for the instrument is provided in the chapter "Remote Control Commands".
There are different types of instrument messages, depending on the direction they are sent:
 - Commands
 - Instrument responses

Commands

Commands (program messages) are messages the controller sends to the instrument. They operate the instrument functions and request information. The commands are subdivided according to two criteria:

- According to the effect they have on the instrument:
 - **Setting commands** cause instrument settings such as a reset of the instrument or setting the frequency.
 - **Queries** cause data to be provided for remote control, e.g. for identification of the instrument or polling a parameter value. Queries are formed by directly appending a question mark to the command header.
- According to their definition in standards:
 - **Common commands**: their function and syntax are precisely defined in standard IEEE 488.2. They are employed identically on all instruments (if implemented). They refer to functions such as management of the standardized status registers, reset and self-test.

- **Instrument control commands** refer to functions depending on the features of the instrument such as frequency settings. Many of these commands have also been standardized by the SCPI committee. These commands are marked as "SCPI confirmed" in the command reference chapters. Commands without this SCPI label are device-specific; however, their syntax follows SCPI rules as permitted by the standard.

Instrument responses

Instrument responses (response messages and service requests) are messages the instrument sends to the controller after a query. They can contain measurement results, instrument settings and information on the instrument status.

A.1.2 LAN Interface Messages

In the LAN connection, the interface messages are called low-level control messages. These messages can be used to emulate interface messages of the GPIB bus.

Command	Long term	Effect on the instrument
&ABO	Abort	Aborts processing of the commands just received.
&DCL	Device Clear	Aborts processing of the commands just received and sets the command processing software to a defined initial state. Does not change the instrument setting.
>L	Go to Local	Transition to the "local" state (manual control). (The instrument automatically returns to remote state when a remote command is sent UNLESS &NREN was sent before.)
>R	Go to Remote	Enables automatic transition from local state to remote state by a subsequent remote command (after &NREN was sent).
&GET	Group Execute Trigger	Triggers a previously active instrument function (e.g. a sweep). The effect of the command is the same as with that of a pulse at the external trigger signal input.
&LLO	Local Lockout	Disables transition from remote control to manual control by means of the front panel keys.
&NREN	Not Remote Enable	Disables automatic transition from local state to remote state by a subsequent remote command. (To re-activate automatic transition use >R.)
&POL	Serial Poll	Starts a serial poll.

A.1.3 SCPI Command Structure

SCPI commands consist of a header and, in most cases, one or more parameters. The header and the parameters are separated by a "white space" (ASCII code 0 to 9, 11 to 32 decimal, e.g. blank). The headers may consist of several mnemonics (keywords). Queries are formed by appending a question mark directly to the header.

The commands can be either device-specific or device-independent (common commands). Common and device-specific commands differ in their syntax.

A.1.3.1 Syntax for Common Commands

Common (= device-independent) commands consist of a header preceded by an asterisk (*), and possibly one or more parameters.

Table A-1: Examples of common commands

*RST	RESET	Resets the instrument.
*ESE	EVENT STATUS ENABLE	Sets the bits of the event status enable registers.
*ESR?	EVENT STATUS QUERY	Queries the contents of the event status register.
*IDN?	IDENTIFICATION QUERY	Queries the instrument identification string.

A.1.3.2 Syntax for Device-Specific Commands



Not all commands used in the following examples are necessarily implemented in the instrument. For demonstration purposes only, assume the existence of the following commands for this section:

- DISPLAY[:WINDOW<1...4>]:MAXimize <Boolean>
- FORMAT:READings:DATA <type>[,<length>]
- HCOpy:DEvice:COLor <Boolean>
- HCOpy:DEvice:CMAP:COLor:RGB <red>,<green>,<blue>
- HCOpy[:IMMediate]
- HCOpy:ITEM:ALL
- HCOpy:ITEM:LABel <string>
- HCOpy:PAGE:DIMensions:QUADrant [<N>]
- HCOpy:PAGE:ORientation LANDscape | PORTrait
- HCOpy:PAGE:SCALE <numeric value>
- MMEMory:COpy <file_source>,<file_destination>
- SENSE:BANDwidth|BWIDth[:RESolution] <numeric_value>
- SENSE:FREQuency:STOP <numeric value>
- SENSE:LIST:FREQuency <numeric_value>{,<numeric_value>}

- [Long and short form](#)..... 949
- [Numeric Suffixes](#)..... 949
- [Optional Mnemonics](#)..... 949

Long and short form

The mnemonics feature a long form and a short form. The short form is marked by upper case letters, the long form corresponds to the complete word. Either the short form or the long form can be entered; other abbreviations are not permitted.

Example:

HCOPY:DEVIce:COLor ON is equivalent to HCOP:DEV:COL ON.



Case-insensitivity

Upper case and lower case notation only serves to distinguish the two forms in the manual, the instrument itself is case-insensitive.

Numeric Suffixes

If a command can be applied to multiple instances of an object, e.g. specific channels or sources, the required instances can be specified by a suffix added to the command. Numeric suffixes are indicated by angular brackets (<1...4>, <n>, <i>) and are replaced by a single value in the command. Entries without a suffix are interpreted as having the suffix 1.

Example:

Definition: HCOpy:PAGE:DImentions:QUADrant [<N>]

Command: HCOP:PAGE:DIM:QUAD2

This command refers to the quadrant 2.



Different numbering in remote control

For remote control, the suffix may differ from the number of the corresponding selection used in manual operation. SCPI prescribes that suffix counting starts with 1. Suffix 1 is the default state and used when no specific suffix is specified.

Some standards define a fixed numbering, starting with 0. If the numbering differs in manual operation and remote control, it is indicated for the corresponding command.

Optional Mnemonics

Some command systems permit certain mnemonics to be inserted into the header or omitted. These mnemonics are marked by square brackets in the description. The instrument must recognize the long command to comply with the SCPI standard. Some commands are considerably shortened by these optional mnemonics.

Example:

Definition: HCOpy[:IMMediate]

Command: HCOP:IMM is equivalent to HCOP



Optional mnemonics with numeric suffixes

Do not omit an optional mnemonic if it includes a numeric suffix that is relevant for the effect of the command.

Example:

Definition: `DISPlay[:WINDow<1...4>]:MAXimize <Boolean>`

Command: `DISP:MAX ON` refers to window 1.

In order to refer to a window other than 1, you must include the optional `WINDow` parameter with the suffix for the required window.

`DISP:WIND2:MAX ON` refers to window 2.

A.1.3.3 SCPI Parameters

Many commands are supplemented by a parameter or a list of parameters. The parameters must be separated from the header by a "white space" (ASCII code 0 to 9, 11 to 32 decimal, e.g. blank).

The parameters required for each command and the allowed range of values are specified in the command description.

Allowed parameters are:

- [Numeric Values](#).....950
- [Special Numeric Values](#).....951
- [Boolean Parameters](#).....951
- [Text Parameters](#).....952
- [Character Strings](#).....952
- [Block Data](#).....952

Numeric Values

Numeric values can be entered in any form, i.e. with sign, decimal point and exponent. Values exceeding the resolution of the instrument are rounded up or down. The mantissa may comprise up to 255 characters, the exponent must lie inside the value range -32000 to 32000. The exponent is introduced by an "E" or "e". Entry of the exponent alone is not allowed.

Example:

`SENS:FREQ:STOP 1500000 = SENS:FREQ:STOP 1.5E6`

Units

For physical quantities, the unit can be entered. If the unit is missing, the basic unit is used. Allowed unit prefixes are:

- G (giga)
- MA (mega), MOHM, MHZ
- K (kilo)
- M (milli)
- U (micro)

- N (nano)

Example:

```
SENSe:FREQ:STOP 1.5GHz = SENSe:FREQ:STOP 1.5E9
```

Some settings allow relative values to be stated in percent. According to SCPI, this unit is represented by the `PCT` string.

Example:

```
HCOP:PAGE:SCAL 90PCT
```

Special Numeric Values

The following mnemonics are special numeric values. In the response to a query, the numeric value is provided.

- **MIN and MAX:** denote the minimum and maximum value.
- **DEF:** denotes a preset value which has been stored in the EPROM. This value conforms to the default setting, as it is called by the `*RST` command.
- **UP and DOWN:** increases or reduces the numeric value by one step. The step width can be specified via an allocated step command for each parameter which can be set via `UP` and `DOWN`.
- **INF and NINF:** INFinity and negative INFinity (NINF) represent the numeric values $9.9E37$ or $-9.9E37$, respectively. `INF` and `NINF` are only sent as instrument responses.
- **NAN:** Not A Number (NAN) represents the value $9.91E37$. `NAN` is only sent as a instrument response. This value is not defined. Possible causes are the division of zero by zero, the subtraction of infinite from infinite and the representation of missing values.

Example:

Setting command: `SENSe:LIST:FREQ MAXimum`

Query: `SENS:LIST:FREQ?`

Response: `3.5E9`

**Queries for special numeric values**

The numeric values associated to `MAXimum`/`MINimum`/`DEFault` can be queried by adding the corresponding mnemonic after the quotation mark.

Example: `SENSe:LIST:FREQ? MAXimum`

Returns the maximum numeric value as a result.

Boolean Parameters

Boolean parameters represent two states. The "ON" state (logically true) is represented by "ON" or a numeric value 1. The "OFF" state (logically untrue) is represented by "OFF" or the numeric value 0. The numeric values are provided as the response for a query.

Example:

Setting command: `HCOPY:DEV:COL ON`

Query: `HCOPY:DEV:COL?`

Response: 1

Text Parameters

Text parameters observe the syntactic rules for mnemonics, i.e. they can be entered using a short or long form. Like any parameter, they have to be separated from the header by a white space. In the response to a query, the short form of the text is provided.

Example:

Setting command: `HCOPY:PAGE:ORIENTATION LANDscape`

Query: `HCOPY:PAGE:ORI?`

Response: LAND

Character Strings

Strings must always be entered in quotation marks (' or ").

Example:

`HCOPY:ITEM:LABEL "Test1"`

`HCOPY:ITEM:LABEL 'Test1'`

Block Data

Block data is a format which is suitable for the transmission of large amounts of data. For example, a command using a block data parameter has the following structure:

```
FORMat:READings:DATA #45168xxxxxxxx
```

The ASCII character # introduces the data block. The next number indicates how many of the following digits describe the length of the data block. In the example the 4 following digits indicate the length to be 5168 bytes. The data bytes follow. During the transmission of these data bytes all end or other control signs are ignored until all bytes are transmitted.

#0 specifies a data block of indefinite length. The use of the indefinite format requires a `NL^END` message to terminate the data block. This format is useful when the length of the transmission is not known or if speed or other considerations prevent segmentation of the data into blocks of definite length.

A.1.3.4 Overview of Syntax Elements

The following tables provide an overview of the syntax elements and special characters.

Table A-2: Syntax elements

:	The colon separates the mnemonics of a command.
;	The semicolon separates two commands of a command line. It does not alter the path.
,	The comma separates several parameters of a command.
?	The question mark forms a query.
*	The asterisk marks a common command.
' '	Quotation marks introduce a string and terminate it (both single and double quotation marks are possible).
#	The hash symbol introduces binary, octal, hexadecimal and block data. <ul style="list-style-type: none"> • Binary: #B10110 • Octal: #O7612 • Hexa: #HF3A7 • Block: #21312
	A "white space" (ASCII-Code 0 to 9, 11 to 32 decimal, e.g. blank) separates the header from the parameters.

Table A-3: Special characters

	<p>Parameters</p> <p>A vertical stroke in parameter definitions indicates alternative possibilities in the sense of "or". The effect of the command differs, depending on which parameter is used.</p> <p>Example:</p> <p>Definition:HCOPY:PAGE:ORIENTATION LANDscape PORTRait</p> <p>Command HCOP:PAGE:ORI LAND specifies landscape orientation</p> <p>Command HCOP:PAGE:ORI PORT specifies portrait orientation</p> <p>Mnemonics</p> <p>A selection of mnemonics with an identical effect exists for several commands. These mnemonics are indicated in the same line; they are separated by a vertical stroke. Only one of these mnemonics needs to be included in the header of the command. The effect of the command is independent of which of the mnemonics is used.</p> <p>Example:</p> <p>DefinitionSENSE:BANDwidth BWIDth[:RESolution] <numeric_value></p> <p>The two following commands with identical meaning can be created:</p> <p>SENS:BAND:RES 1</p> <p>SENS:BWID:RES 1</p>
[]	<p>Mnemonics in square brackets are optional and may be inserted into the header or omitted.</p> <p>Example: HCOPY[:IMMEDIATE]</p> <p>HCOP: IMM is equivalent to HCOP</p>
{}	<p>Parameters in curly brackets are optional and can be inserted once or several times, or omitted.</p> <p>Example: SENSE:LIST:FREQUENCY <numeric_value>{,<numeric_value>}</p> <p>The following are valid commands:</p> <p>SENS:LIST:FREQ 10</p> <p>SENS:LIST:FREQ 10,20</p> <p>SENS:LIST:FREQ 10,20,30,40</p>

A.1.3.5 Structure of a Command Line

A command line may consist of one or several commands. It is terminated by one of the following:

- <New Line>
- <New Line> with EOI
- EOI together with the last data byte

Several commands in a command line must be separated by a semicolon ";".

Example:

```
MMEM: COPY "Test1", "MeasurementXY"; :HCOP: ITEM ALL
```

This command line contains two commands. The first command belongs to the MMEM system, the second command belongs to the HCOP system. If the next command belongs to a different command system, the semicolon is followed by a colon.

Example:

```
HCOP: ITEM ALL; :HCOP: IMM
```

This command line contains two commands. Both commands are part of the HCOP command system, i.e. they have one level in common.

If the successive commands belong to the same system, having one or several levels in common, the command line can be abbreviated. When abbreviating the command line, the second command begins with the level below HCOP. The colon after the semicolon is omitted. The abbreviated form of the command line reads as follows:

```
HCOP: ITEM ALL; IMM
```

Example:

```
HCOP: ITEM ALL
HCOP: IMM
```

A new command line always begins with the complete path.

A.1.3.6 Responses to Queries

A query is defined for each setting command unless explicitly specified otherwise. It is formed by adding a question mark to the associated setting command. According to SCPI, the responses to queries are partly subject to stricter rules than in standard IEEE 488.2.

- The requested parameter is transmitted without a header.
Example: `HCOP: PAGE: ORI?`, **Response:** `LAND`
- Maximum values, minimum values and all other quantities that are requested via a special text parameter are returned as numeric values.
Example: `SENSe: FREQuency: STOP? MAX`, **Response:** `3.5E9`
- Numeric values are output without a unit. Physical quantities are referred to the basic units or to the units set using the `Unit` command. The response `3.5E9` in the previous example stands for 3.5 GHz.

- Truth values (Boolean values) are returned as 0 (for OFF) and 1 (for ON).
Example:
Setting command: `HCOPY:DEV:COL ON`
Query: `HCOPY:DEV:COL?`
Response: 1
- Text (character data) is returned in a short form.
Example:
Setting command: `HCOPY:PAGE:ORIENTATION LANDscape`
Query: `HCOPY:PAGE:ORI?`
Response: LAND
- Invalid numerical results
In some cases, particularly when a result consists of multiple numeric values, invalid values are returned as 9.91E37 (not a number).

A.1.4 Command Sequence and Synchronization

IEEE 488.2 defines a distinction between overlapped and sequential commands:

- A sequential command always completes executing before the next command starts. Commands that are processed quickly are defined as sequential commands. They are not implemented in the instrument. However, the execution time of most of the commands is so short that they act as sequential commands, if they are sent in separate command lines.
- An overlapping command is still running when the next command starts. Usually, an overlapping command takes a certain time to process its task, and thus allows the program to execute other tasks, while it is still running. If overlapping commands have to follow a specific order, for example to avoid incorrect measurement readings, they must be executed in sequence. This is called synchronization between the controller and the instrument.

Several setting commands within a command line are not necessarily processed in the order they are received. Even if they are implemented as sequential commands. To follow a particular sequence, send each command in a separate line.



As a rule, send commands and queries in different program messages.

A.1.4.1 Preventing Overlapping Execution

To prevent an overlapping execution of commands, one of the commands `*OPC`, `*OPC?` or `*WAI` can be used. All three commands cause a certain action only to be carried out after the hardware has been set. The controller can be forced to wait for the corresponding action to occur.

Table A-4: Synchronization using *OPC, *OPC? and *WAI

Command	Action	Programming the controller
*OPC	Sets the Operation Complete bit in the ESR after all previous commands have been executed.	<ul style="list-style-type: none"> Setting bit 0 in the ESE Setting bit 5 in the SRE Waiting for service request (SRQ)
*OPC?	Stops command processing until 1 is returned. This occurs when all pending operations are completed.	Send *OPC? directly after the command whose processing must be terminated before other commands can be executed.
*WAI	Stops further command processing until all commands sent before *WAI have been executed.	Send *WAI directly after the command whose processing must be terminated before other commands are executed.

Command synchronization using *WAI or *OPC? is a good choice if the overlapped command takes only little time to process. The two synchronization commands simply block overlapped execution of the command. Append the synchronization command to the overlapping command, for example:

```
SINGLE; *OPC?
```

For time consuming overlapped commands, you can allow the controller or the instrument to do other useful work while waiting for command execution. Use one of the following methods:

*OPC with a service request

1. Set the OPC mask bit (bit no. 0) in the ESE: *ESE 1
2. Set bit no. 5 in the SRE: *SRE 32 to enable ESB service request.
3. Send the overlapped command with *OPC .
4. Wait for a service request.

The service request indicates that the overlapped command has finished.

*OPC? with a service request

1. Set bit no. 4 in the SRE: *SRE 16 to enable MAV service request.
2. Send the overlapped command with *OPC?.
3. Wait for a service request.

The service request indicates that the overlapped command has finished.

Event status register (ESE)

1. Set the OPC mask bit (bit no. 0) in the ESE: *ESE 1
2. Send the overlapped command without *OPC, *OPC? or *WAI.

3. Poll the operation complete state periodically (with a timer) using the sequence:
*OPC; *ESR?

A return value (LSB) of 1 indicates that the overlapped command has finished.

A.1.4.2 Examples to Command Sequence and Synchronization

See the following examples to command sequences and synchronization. Some examples given illustrate possible constellations for overlapping tasks.

Example: Commands and queries in one message

The response to a query combined in a program message with commands that affect the queried value is not predictable.

The following commands always return the specified result:

```
:FREQ:STAR 1GHZ;SPAN 100 :FREQ:STAR?
```

Result:

```
1000000000 (1 GHz)
```

Whereas the result for the following commands is not specified by SCPI:

```
:FREQ:STAR 1GHZ;STAR?;SPAN 1000000
```

The result could be the value of `STARt` before the command was sent since the instrument might defer executing the individual commands until a program message terminator is received. The result could also be 1 GHz if the instrument executes commands as they are received.

Example: Overlapping command with *OPC

The instrument implements `*RST` as an overlapped command. Assuming that `*RST` takes longer to execute than `*OPC`, sending the following command sequence results in initiating a reset and, after some time, setting the `OPC` bit in the `ESR`:

```
*RST; *OPC
```

Sending the following commands still initiates a reset:

```
*RST; *OPC; *CLS
```

However, since the operation is still pending when the instrument executes `*CLS`, forcing it into the "Operation Complete Command Idle" State (OCIS), `*OPC` is effectively skipped. The `OPC` bit is not set until the instrument executes another `*OPC` command.

Example: Overlapped command followed by non-conflicting commands

Suppose that the instrument is switched on to provide a real time test signal that requires some calculation time. At the same time, some settings for the configuration of a different signal are made which do not interact with the generated signal (for example the signal may be used later on). The signal generation and the signal configuration are independent from each other, so there is no need to synchronize the following overlapped commands:

```
SOUR:BB:3GPP:STAT ON
```

```
SOUR:BB:GSM:FORM FSK2
```

Example: Overlapped command followed by conflicting commands

Suppose that the generator is switched on to provide a real time test signal that requires some calculation time. This signal is to be added to a waveform from the second baseband generator. In this case, the application program has to make sure that the real signal is available in the added signal before further action is started. This involves an appropriate synchronization technique for the first command (the following sequence assumes an appropriate routing):

```
SOUR:BB:3GPP:STAT ON
```

The instrument waits until command has finished.

```
SOUR2:BB:GSM:STAT ON
```

Depending on the selected synchronization techniques, non-conflicting commands can be executed while waiting until the synchronized overlapped command has finished.

Example: Polling the progress of the zeroing process

Suppose that you start the zeroing for a connected power sensor via the remote control command `SENS1:ZERO`. This process blocks the processing of further tasks during execution. The query for completeness is performed with the `*OPC?` command. It returns a 1 in the output buffer when the process is completed.

```
SENS:ZERO;*OPC?
```

Instead of waiting via `*OPC?`, you can perform alternative tasks while the zeroing is running, as for example updating the GUI or adjusting other instruments. Synchronize the commands by querying the progress of the zeroing process periodically via the event status register `*ESR?`:

```
*SRE 32
```

Sets the service request enable. The bit is set when an event in the event status register occurs.

```
*ESE 1
```

Configures the mask of the event status register to "Operation Complete".

```
SENS:ZERO;*OPC
```

Sets the evaluation via the status byte query. It uses `*OPC?` as the reference.

```
*CLS
```

Clears all status registers.

Even if the instrument is busy, you can perform this procedure, since the query is executed in a subchannel.

A.1.5 Status Reporting System

The status reporting system stores all information on the current operating state of the instrument, and on errors which have occurred. This information is stored in the status registers and in the error queue.

You can query both with the commands of the [STATus Subsystem](#).

A.1.5.1 Hierarchy of the Status Registers

The Figure A-1 shows the hierarchical structure of information in the status registers (ascending from left to right).

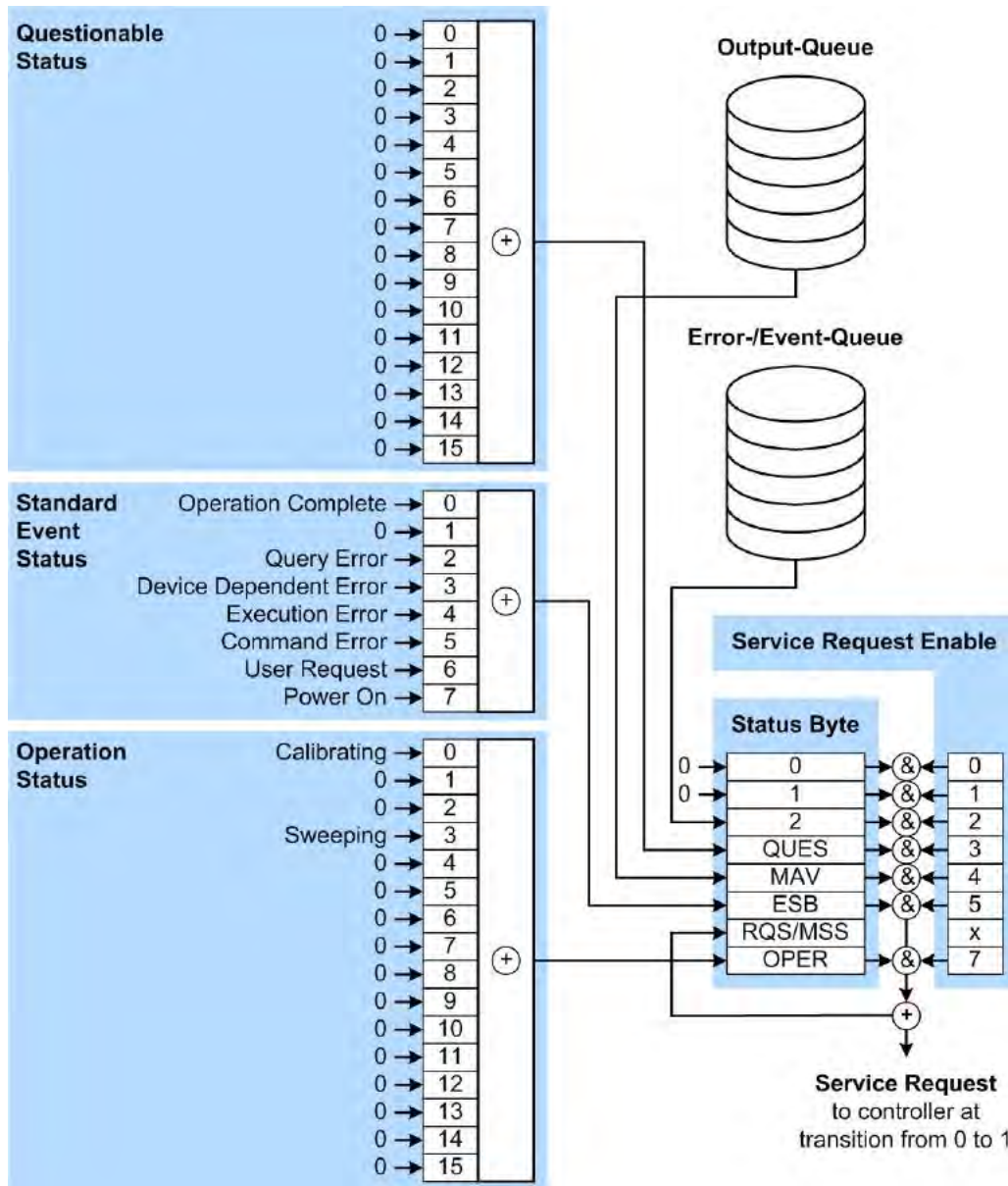

Figure A-1: Graphical overview of the status registers hierarchy

- OPER = Operation Status Summary Bit
- RQS/MSS = Service Request Generation
- ESB = Standard Event Status Summary Bit
- MAV = Message Available in Output Queue
- QUES = Questionable Status Summary Bit
- 2 = Error- /Event-Queue
- 1, 0 = not used

Note: This legend explains the abbreviations to the Status Byte Register.

The R&S SMBV100B uses the following status registers:

- **Status Byte (STB)** and **Service Request Enable (SRE)**, see [Chapter A.1.5.3, "Status Byte \(STB\) and Service Request Enable Register \(SRE\)"](#), on page 962.
- **Standard Event Status**, i.e. the Event status Register (ESR) and the Event Status Enable (ESE), see [Chapter A.1.5.4, "Event Status Register \(ESR\) and Event Status Enable Register \(ESE\)"](#), on page 963.
- **Questionable Status** and **Operation Status**, the (SCPI status registers, see [Chapter A.1.5.2, "Structure of a SCPI Status Register"](#), on page 960, [Chapter A.1.5.5, "Questionable Status Register \(STATus:QUESTionable\)"](#), on page 964 and [Chapter A.1.5.6, "Operation Status Register \(STATus:OPERation\)"](#), on page 964.
- **Output-Queue**
The output queue contains the messages the instrument returns to the controller. It is not part of the status reporting system but determines the value of the `MAV` bit in the `STB` and thus is represented in the overview.
- **Error- /Event-Queue**
The error-/event-queue contains all errors and events that have occurred in the past. When reading the queue, the instrument starts with the first occurred error/event.

All status registers have the same internal structure.



SRE, ESE

The service request enable register `SRE` can be used as `ENABLE` part of the `STB` if the `STB` is structured according to SCPI. By analogy, the `ESE` can be used as the `ENABLE` part of the `ESR`.

A.1.5.2 Structure of a SCPI Status Register

Each standard SCPI register consists of 5 parts. Each part has a width of 16 bits and has different functions. The individual bits are independent of each other, i.e. each hardware status is assigned a bit number which is valid for all five parts. Bit 15 (the most significant bit) is set to zero for all parts. Thus the contents of the register parts can be processed by the controller as positive integers.

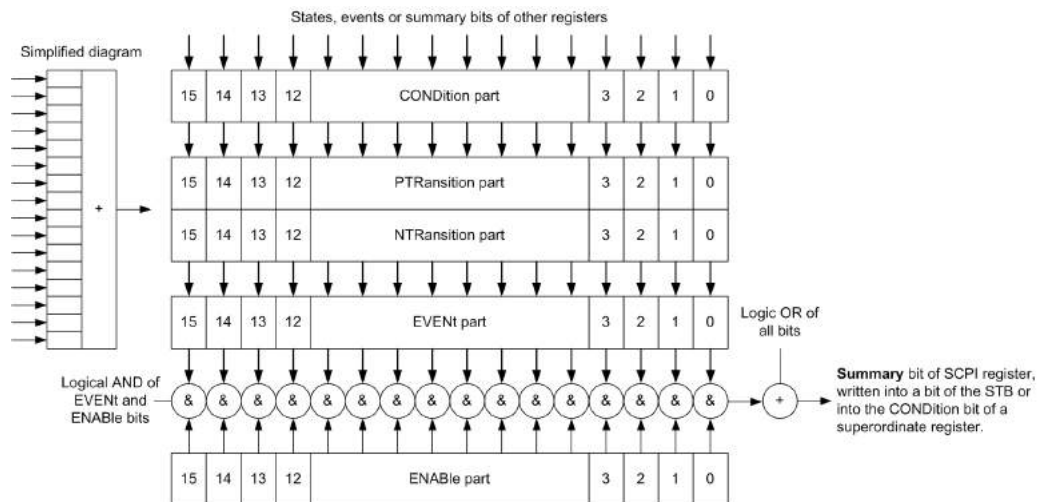

Figure A-2: The status-register model

Description of the five status register parts

The five parts of a SCPI register have different properties and functions:

- **CONDition**

The **CONDition** part is written into directly by the hardware or the sum bit of the next lower register. Its contents reflect the current instrument status. This register part can only be read, but not written into or cleared. Its contents are not affected by reading.

- **PTRansition / NTRansition**

The two transition register parts define which state transition of the **CONDition** part (none, 0 to 1, 1 to 0 or both) is stored in the **EVENT** part.

The **Positive-TRansition** part acts as a transition filter. When a bit of the **CONDition** part is changed from 0 to 1, the associated **PTR** bit decides whether the **EVENT** bit is set to 1.

- **PTR** bit =1: the **EVENT** bit is set.
- **PTR** bit =0: the **EVENT** bit is not set.

This part can be written into and read as required. Its contents are not affected by reading.

The **Negative-TRansition** part also acts as a transition filter. When a bit of the **CONDition** part is changed from 1 to 0, the associated **NTR** bit decides whether the **EVENT** bit is set to 1.

- **NTR** bit =1: the **EVENT** bit is set.
- **NTR** bit =0: the **EVENT** bit is not set.

This part can be written into and read as required. Its contents are not affected by reading.

- **EVENT**

The **EVENT** part indicates whether an event has occurred since the last reading, it is the "memory" of the condition part. It only indicates events passed on by the transition filters. It is permanently updated by the instrument. This part can only be

read by the user. Reading the register clears it. This part is often equated with the entire register.

- **ENABLE**

The `ENABLE` part determines whether the associated `EVENT` bit contributes to the sum bit (see below). Each bit of the `EVENT` part is "ANDed" with the associated `ENABLE` bit (symbol '&'). The results of all logical operations of this part are passed on to the sum bit via an "OR" function (symbol '+').

`ENABLE` bit = 0: the associated `EVENT` bit does not contribute to the sum bit

`ENABLE` bit = 1: if the associated `EVENT` bit is "1", the sum bit is set to "1" as well.

This part can be written into and read by the user as required. Its contents are not affected by reading.

Sum bit

The sum bit is obtained from the `EVENT` and `ENABLE` part for each register. The result is then entered into a bit of the `CONDition` part of the higher-order register.

The instrument automatically generates the sum bit for each register. Thus an event can lead to a service request throughout all levels of the hierarchy.

A.1.5.3 Status Byte (STB) and Service Request Enable Register (SRE)

The `Status Byte` (STB) is already defined in IEEE 488.2. It provides a rough overview of the instrument status by collecting the pieces of information of the lower registers. A special feature is that bit 6 acts as the sum bit of the remaining bits of the status byte.

The STB is read using the command `*STB?` or a serial poll.

The `Status Byte` (STB) is linked to the `Service Request Enable` (SRE) register. Each bit of the STB is assigned a bit in the SRE. Bit 6 of the SRE is ignored. If a bit is set in the SRE and the associated bit in the STB changes from 0 to 1, a service request (SRQ) is generated. The SRE can be set using the command `*SRE` and read using the command `*SRE?`.

Table A-5: Meaning of the bits used in the status byte

Bit No.	Meaning
0...1	Not used
2	Error Queue not empty The bit is set when an entry is made in the error queue. If this bit is enabled by the SRE, each entry of the error queue generates a service request. Thus an error can be recognized and specified in greater detail by polling the error queue. The poll provides an informative error message. This procedure is to be recommended since it considerably reduces the problems involved with remote control.
3	QUESTIONable status register summary bit The bit is set if an <code>EVENT</code> bit is set in the <code>QUESTIONable</code> status register and the associated <code>ENABLE</code> bit is set to 1. A set bit indicates a questionable instrument status, which can be specified in greater detail by querying the <code>STATUS:QUESTIONable</code> status register.

Bit No.	Meaning
4	MAV bit (message available) The bit is set if a message is available in the output queue which can be read. This bit can be used to enable data to be automatically read from the instrument to the controller.
5	ESB bit Sum bit of the event status register. It is set if one of the bits in the event status register is set and enabled in the event status enable register. Setting of this bit indicates a serious error which can be specified in greater detail by polling the event status register.
6	MSS bit (master status summary bit) The bit is set if the instrument triggers a service request. This is the case if one of the other bits of this registers is set together with its mask bit in the service request enable register SRE.
7	STATUS:OPERation status register summary bit The bit is set if an EVENT bit is set in the OPERATION status register and the associated ENABLE bit is set to 1. A set bit indicates that the instrument is just performing an action. The type of action can be determined by querying the STATUS:OPERation status register.

A.1.5.4 Event Status Register (ESR) and Event Status Enable Register (ESE)

The ESR is defined in IEEE 488.2. It can be compared with the EVENT part of a SCPI register. The event status register can be read out using command *ESR?.

The ESE corresponds to the ENABLE part of a SCPI register. If a bit is set in the ESE and the associated bit in the ESR changes from 0 to 1, the ESB bit in the STB is set. The ESE register can be set using the command *ESE and read using the command *ESE?.

Table A-6: Meaning of the bits used in the event status register

Bit No.	Meaning
0	Operation Complete This bit is set on receipt of the command *OPC exactly when all previous commands have been executed.
1	Not used
2	Query Error This bit is set if either the controller wants to read data from the instrument without having sent a query, or if it does not fetch requested data and sends new instructions to the instrument instead. The cause is often a query which is faulty and hence cannot be executed.
3	Device-dependent Error This bit is set if a device-dependent error occurs. An error message with a number between -300 and -399 or a positive error number, which denotes the error in greater detail, is entered into the error queue.
4	Execution Error This bit is set if a received command is syntactically correct but cannot be performed for other reasons. An error message with a number between -200 and -300, which denotes the error in greater detail, is entered into the error queue.

Bit No.	Meaning
5	Command Error This bit is set if a command is received, which is undefined or syntactically incorrect. An error message with a number between -100 and -200, which denotes the error in greater detail, is entered into the error queue.
6	User Request This bit is set when the instrument is switched over to manual control.
7	Power On (supply voltage on) This bit is set on switching on the instrument.

A.1.5.5 Questionable Status Register (STATus:QUESTionable)

This register contains information on questionable instrument states. Such states may occur when the instrument is not operated in compliance with its specifications.

To read the register, use the query commands `STAT:QUEST:COND?` or `STAT:QUEST[:EVEN]?`.

Table A-7: Meaning of the bits used in the questionable status register

Bit No.	Meaning
0–15	Not used

A.1.5.6 Operation Status Register (STATus:OPERation)

This condition part contains information on the actions currently being performed by the instrument, while the event part contains information on the actions performed by the instrument since the last readout of the register.

To read the register, use the query commands `STAT:OPER:COND?` or `STAT:OPER[:EVEN]?`.

Table A-8: Meaning of the bits used in the operation status register

Bit No.	Meaning
0	Calibrating The bit is set during the calibration phase.
1–2	Not used
3	Sweeping This bit is set during a sweep in automatic or single mode.
4–15	Not used

A.1.5.7 Application of the Status Reporting System

The purpose of the status reporting system is to monitor the status of one or several devices in a measuring system. To do this and react appropriately, the controller must

receive and evaluate the information of all devices. The following standard methods are used:

- **Service request** (SRQ) initiated by the instrument
- **Serial poll** of all devices in the bus system, initiated by the controller to find out who sent an SRQ and why
- Query of a **specific instrument status** by commands
- Query of the **error queue**

Service Request

Under certain circumstances, the instrument can send a service request (SRQ) to the controller. Usually this service request initiates an interrupt at the controller, to which the control program can react appropriately. An SRQ is always initiated if one or several of bits 2, 4 or 5 of the status byte are set and enabled in the SRE. Each of these bits combines the information of the error queue or the output buffer. To use the possibilities of the service request effectively, all bits should be set to "1" in the enable registers SRE and ESE.

Example:

Use command `*OPC` to generate an SRQ .

`*ESE 1` - set bit 0 of ESE (Operation Complete)

`*SRE 32` - set bit 5 of SRE (ESB).

After its settings have been completed, the instrument generates an SRQ.

The SRQ is the only possibility for the instrument to become active on its own. Each controller program should set the instrument such that a service request is initiated in the case of malfunction. The program should react appropriately to the service request.

Serial Poll

In a serial poll, just as with command `*STB`, the status byte of an instrument is queried. However, the query is realized via interface messages and is thus clearly faster.

The serial poll method is defined in IEEE 488.1 and used to be the only standard possibility for different instruments to poll the status byte. The method also works for instruments which do not adhere to SCPI or IEEE 488.2.

The serial poll is mainly used to obtain a fast overview of the state of several instruments connected to the controller.

Query of an instrument status

Each part of any status register can be read using queries. There are two types of commands:

- The common commands `*ESR?`, `*IDN?`, `*IST?`, `*STB?` query the higher-level registers.
- The commands of the `STATus` system query the SCPI registers (`STATus:QUEStionable...`)

The returned value is always a decimal number that represents the bit pattern of the queried register. This number is evaluated by the controller program.

Queries are usually used after an SRQ in order to obtain more detailed information on the cause of the SRQ.

Error Queue

Each error state in the instrument leads to an entry in the error queue. The entries of the error queue are detailed plain text error messages that can be looked up in the Error Log or queried via remote control using `SYSTem:ERRor[:NEXT]?`. Each call of `SYSTem:ERRor[:NEXT]?` provides one entry from the error queue. If no error messages are stored there any more, the instrument responds with 0, "No error".

The error queue should be queried after every SRQ in the controller program as the entries describe the cause of an error more precisely than the status registers. Especially in the test phase of a controller program the error queue should be queried regularly since faulty commands from the controller to the instrument are recorded there as well.

A.1.5.8 Reset Values of the Status Reporting System

The following table contains the different commands and events causing the status reporting system to be reset. None of the commands, except of `*RST` and `SYSTem:PRESet` affect the functional instrument settings. In particular, `DCL` does not change the instrument settings.

Table A-9: Resetting the status reporting system

Event	Switching on supply voltage Power-On-Status-Clear		DCL, SDC (Device Clear, Selected Device Clear)	*RST or SYSTem: PRESet	STATus: PRESet	*CLS
	0	1				
Clear STB, ESR	-	Yes	-	-	-	Yes
Clear SRE, ESE	-	Yes	-	-	-	-
Clear PPE	-	Yes	-	-	-	-
Clear error queue	Yes	Yes	-	-	-	Yes
Clear output buffer	Yes	Yes	Yes	1)	1)	1)
Clear command processing and input buffer	Yes	Yes	Yes	-	-	-

1) The first command in a command line that immediately follows a <PROGRAM MESSAGE TERMINATOR> clears the output buffer.

A.1.6 General Programming Recommendations

Initial instrument status before changing settings

Manual operation is designed for maximum possible operating convenience. In contrast, the priority of remote control is the "predictability" of the instrument status. Thus, when a command attempts to define incompatible settings, the command is ignored and the instrument status remains unchanged, i.e. other settings are not automatically adapted. Therefore, control programs should always define an initial instrument status (e.g. using the *RST command) and then implement the required settings.

Command sequence

As a general rule, send commands and queries in different program messages. Otherwise, the result of the query may vary depending on which operation is performed first (see also Preventing Overlapping Execution).

Reacting to malfunctions

The service request is the only possibility for the instrument to become active on its own. Each controller program should instruct the instrument to initiate a service request in case of malfunction. The program should react appropriately to the service request.

Error queues

The error queue should be queried after every service request in the controller program as the entries describe the cause of an error more precisely than the status registers. Especially in the test phase of a controller program the error queue should be queried regularly since faulty commands from the controller to the instrument are recorded there as well.

A.2 Telnet program examples

The following program example shows a simple `TcpClient` class that is intended to explain on how to get started with programming of sockets.

The example sets up a socket communication to R&S SMBV100B and opens a simple user interface, very similar to the telnet, which allows input of commands. To enable real automation, further development of the program is required.

TcpClient.h

```
#include <string>
//defines structs for socket handling
#include <netinet/in.h>
using namespace std;
typedef struct sockaddr_in SockAddrStruct;
typedef struct hostent      HostInfoStruct;
```

```

class TcpClient
{
public:
    TcpClient();
    ~TcpClient();
    void connectToServer( string &hostname, int port );
    void disconnect( );
    void transmit( string &txString );
    void receive( string &rxString );
    string getCurrentHostName( ) const;
    int    getCurrentPort( ) const;
private:
    string      currentHostName;
    int         currentPort;
    int         currentSocketDescr;
    SockAddrStruct  serverAddress;
    HostInfoStruct * currentHostInfo;
    bool        clientIsConnected;
    int         receiveBufferSize;
};

```

TcpClient.cpp

```

#include <string>
//defines structs for socket handling
#include <netinet/in.h>
using namespace std;
typedef struct sockaddr_in SockAddrStruct;
typedef struct hostent     HostInfoStruct;
class TcpClient
{
public:
    TcpClient();
    ~TcpClient();
    void connectToServer( string &hostname, int port );
    void disconnect( );
    void transmit( string &txString );
    void receive( string &rxString );
    string getCurrentHostName( ) const;
    int    getCurrentPort( ) const;
private:
    string      currentHostName;
    int         currentPort;
    int         currentSocketDescr;
    SockAddrStruct  serverAddress;
    HostInfoStruct * currentHostInfo;
    bool        clientIsConnected;
    int         receiveBufferSize;
};

```

```

#include <netdb.h>
#include <netinet/in.h>
#include <unistd.h>
#include "TcpClient.h"
TcpClient::TcpClient()
: currentHostName( "" )
, currentPort( 0 )
, currentSocketDescr( 0 )
, serverAddress ( )
, currentHostInfo( NULL )
, clientIsConnected( false )
, receiveBufferSize( 1024 )
{
}
TcpClient::~~TcpClient()
{
    currentHostInfo = NULL;
}

void TcpClient::connectToServer( string &hostname, int port )
{
    currentHostInfo = gethostbyname( hostname.c_str( ) );
    if( currentHostInfo == NULL )
    {
        currentHostName = "";
        currentPort = 0;
        currentHostInfo = NULL;
        clientIsConnected = false;
        printf("error connecting host\n" );
    }
    currentHostName = hostname;
    currentPort = port;
    currentSocketDescr = socket(AF_INET, SOCK_STREAM, 0);
    if( currentSocketDescr == 0 )
    {
        currentHostName = "";
        currentPort = 0;
        currentHostInfo = NULL;
        clientIsConnected = false;
        printf("can't create socket\n" );
    }
    serverAddress.sin_family = currentHostInfo->h_addrtype;
    serverAddress.sin_port = htons( currentPort );
    memcpy( (char *) &serverAddress.sin_addr.s_addr,
        currentHostInfo->h_addr_list[0], currentHostInfo->h_length );
    if( connect( currentSocketDescr, ( struct sockaddr *) &serverAddress,
        sizeof( serverAddress ) ) < 0 )
    {
        throw string("can't connect server\n" );
    }
}

```



```
        clientIsConnected = true;
    }
void TcpClient::disconnect( )
{
    if( clientIsConnected )
    {
        close( currentSocketDescr );
    }
    currentSocketDescr = 0;
    currentHostName    = "";
    currentPort        = 0;
    currentHostInfo    = NULL;
    clientIsConnected = false;
}
void TcpClient::transmit( string &txString )
{
    if( !clientIsConnected )
    {
        throw string("connection must be established before any data can be sent\n");
    }
    char * transmitBuffer = new char[txString.length() +1];
    memcpy( transmitBuffer, txString.c_str(), txString.length() );
    transmitBuffer[txString.length()] = '\n'; //newline is needed!
    if( send( currentSocketDescr, transmitBuffer, txString.length() + 1, 0 ) < 0 )
    {
        throw string("can't transmit data\n");
    }
    delete [] transmitBuffer;
}
void TcpClient::receive( string &rxString )
{
    if( !clientIsConnected )
    {
        throw string("connection must be established before any data can be received\n");
    }
    char * receiveBuffer = new char[receiveBufferSize];
    memset( receiveBuffer, 0, receiveBufferSize );
    bool receiving = true;
    while( receiving )
    {
        int receivedByteCount = recv( currentSocketDescr,
            receiveBuffer, receiveBufferSize, 0 );
        if( receivedByteCount < 0 )
        {
            throw string("error while receiving data\n");
        }
        rxString += string( receiveBuffer );
        receiving = ( receivedByteCount == receiveBufferSize );
    }
    delete [] receiveBuffer;
}
```

```
    }
string TcpClient::getCurrentHostName( ) const
{
    return currentHostName;
}
int TcpClient::getCurrentPort( ) const
{
    return currentPort;
}
```

TelnetClient.cpp

```
#include <iostream>
#include "TcpClient.h"
void printUsage()
{
    cout<<"usage: EthernetRawCommand <server-ip> [scpi-command]"<<endl;
}
int main( int argc, char *argv[] )
{
    int errorCode          = 0; //no error
    bool useSingleCommand = false;
    string singleCommand  = "";
    string hostname       = "";
    int    port           = 5025;
    string input          = "";
    TcpClient client;
    switch( argc )
    {
        case 3:
            useSingleCommand = true;
            singleCommand    = argv[2];
        case 2:
            hostname        = argv[1];
            break;
        default:
            printUsage();
            return(-1);
    }
    try
    {
        client.connectToServer( hostname, port );
        bool terminate = false;
        while( !terminate )
        {
            char buffer[1024];
            if( useSingleCommand )
            {
                input = singleCommand; //send string
            }
        }
    }
}
```

```

else
{
    cin.getline( buffer, 1024 );
    input = buffer;
    if( input == "end" )
    {
        terminate = true;
    }
}
if( !terminate)
{
    client.transmit( input ); //send string
    int qPos = input.find( "?", 0 );
    //receive string only when needed
    if( qPos > 0 )
    {
        string rcStr = "";
        client.receive( rcStr );
        cout << rcStr << endl;
    }
}
if( useSingleCommand )
{
    terminate = true;
}
}
}catch( const string errorString )
{
    cout<<errorString<<endl;
}
client.disconnect( );
return errorCode;
}

```

A.3 Extensions for User Files

The [Table A-10](#) lists all available file extensions for user files. The currently available files on the instrument depend on the installed options.

Table A-10: List of the automatically assigned file extensions in the instrument

Function	List type	Contents	File suffix
Instrument State	Settings	Instrument settings	*.savrc.txt
License Key		License Key	*.xml
"User Correction"	List	User-defined level correction values	*.uco
"List Mode"	List	User-defined frequency/level value pairs	*.lsw
	Settings	Response file	*.txt

Function	List type	Contents	File suffix
"NRP Settings"	Settings	R&S NRP Settings	*.nrp, *.rsu
SCPI command list	List	Export file containing list of SCPIs	*.iec
R&S Support Info Archive	Support File	Automatically collected support information	*.tar.gz
Tutorials	Tutorial files	Lists containing SCPIs and explanations	*.tut
	Waveform	ARB waveforms ARB multi-segment waveforms	*.wv
	Waveform	ARB multi-carrier settings	*.arb_multcar
	Configuration data	Configuration file for creation of multisegment ARB waveforms	*.inf_mswv
	Play List	ARB Sequencing List	*.wvs
	Data List	Digital modulation data	*.dm_iqd *.tdm
	Control List	Data to control digital modulation	*.dm_iqc
	Settings	Digital modulation settings	*.dm
	User Standard	Digital modulation user standard	*.dm_stu
	User Mapping	Digital modulation user mapping	*.vam
	User Filter	Digital modulation user filter	*.vaf
	Setting	Envelope shaping function (shaping table)	*.iq_lut *.iq_lutpv
	Settings	Envelope shaping function (polynomial coefficients)	*.iq_poly
	Settings	DPD Settings	*.dpd
	Setting	Predistortion function (AM/AM and AM/PM shaping table)	*.dpd_magn *.dpd_phase
	Settings	Predistortion function (polynomial coefficients)	*.dpd_poly
	Settings	Fading data	*.fad
	Settings	Vehicle description file	*.xvd
	Settings	Trajectory description file	*.xtd
	Settings	User defined dynamic	*.fad_udyn
	Settings	Antenna pattern	*.ant_pat
	Settings	Complete setting of the REG dialog	*.reg
	Settings	REG Object settings	*.reg_obj
	Settings	Complete settings of the GSM/EDGE dialog	*.gsm
	Slot	User-defined slot data	*.gsm_slu
	Frame	User-defined frame data	*.gsm_fu

Function	List type	Contents	File suffix
	Slot	Higher symbol rate slot	*.gsm_hslu
	Frame	Higher symbol rate frame	*.gsm_hfu
	Bluetooth Settings	Complete setting of the Bluetooth dialog	*.bto
	TETRA Settings	Complete setting of the TETRA dialog	*.tetra
	Settings	Complete setting of the 3GPP FDD dialog	*.3g
	Settings	Channel coding enhanced DPCH channels (downlink)	*.3g_ccod_dl
	Settings	Channel coding enhanced DPDCH channels (uplink)	*.3g_ccod_ul
	Settings	User scheduling	*.3g_sch
	Settings	Complete setting of the CDMA2000 dialog	*.cdma2k
	Settings	Complete setting of the TD-SCDMA2000 dialog	*.tdscdma
	Settings	Test Model for TD-SCDMA2000	*.tdtmd
	Settings	Complete setting of the 1xEV-DO dialog	*.1xevdo
	Settings	Complete setting of the IEEE 802.11 WLAN dialog	*.wlann
	Settings	Beamforming data	*.bmf
	Settings	Complete setting of the IEEE 802.16 WIMAX dialog	*.wimax
	Settings	Complete setting of the EUTRA/LTE dialog	*.eutra *.lte
	Settings	TDD Settings	*.lte_tdd
	Settings	User-defined IQ-File	*.iqw
	Settings	Complete setting of the 5G dialog	*.c5g
	Settings	User Filter	*.dat
	Settings	Complete setting of the DVB dialog	*.dvb
	Settings	DVB Transport Stream	*.gts *.ts *.trp
	Settings	Complete setting of the NFC dialog	*.nfc
	Settings	Complete setting of the BB Power Ramp dialog	*.pwr_ramp

B Hardware Interfaces

This section covers hardware-related topics, like pin assignment of the IEC 625/IEEE 488 interface.

The remote control interfaces are described in details in [Chapter 11, "Network Operation and Remote Control"](#), on page 520.

All other interfaces are described in [Chapter 2.2, "Instrument Tour"](#), on page 40.

For specifications, refer to the data sheet.

B.1 GPIB-Bus Interface

Pin assignment

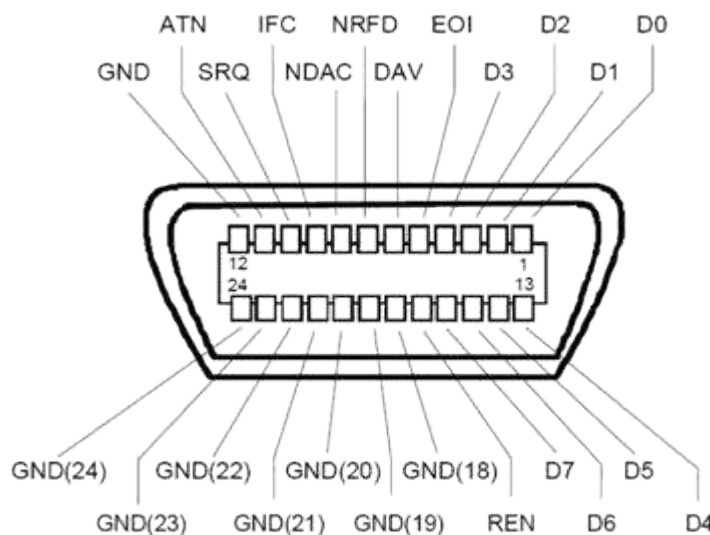

Figure B-1: Pin assignment of GPIB-bus (IEEE 488) interface

Bus lines

- Data bus with 8 lines D0 to D7:
The transmission is bit-parallel and byte-serial in the ASCII/ISO code. D0 is the least significant bit, D7 the most significant bit.
- Control bus with five lines:
IFC (Interface Clear): active LOW resets the interfaces of the instruments connected to the default setting.
ATN (Attention): active LOW signals the transmission of interface messages, inactive HIGH signals the transmission of device messages.

SRQ (Service Request): active LOW enables the connected device to send a service request to the controller.

REN (Remote Enable): active LOW permits switchover to remote control.

EOI (End or Identify): has two functions in connection with ATN:

- ATN=HIGH active LOW marks the end of data transmission.
- ATN=LOW active LOW triggers a parallel poll.

- Handshake bus with three lines:

DAV (Data Valid): active LOW signals a valid data byte on the data bus.

NRFD (Not Ready For Data): active LOW signals that one of the connected devices is not ready for data transfer.

NDAC (Not Data Accepted): active LOW signals that the instrument connected is accepting the data on the data bus.

Interface functions

Instruments which can be controlled via GPIB-bus interface can be equipped with different interface functions. [Table B-1](#) lists the interface functions for the R&S SMBV100B.

Table B-1: GPIB-bus interface functions

Control character	Interface function
SH1	Handshake source function (source handshake), full capability
AH1	Handshake sink function (acceptor handshake), full capability
L4	Listener function, full capability, de-addressed by MTA.
T6	Talker function, full capability, ability to respond to serial poll, deaddressed by MLA
SR1	Service request function (Service Request), full capability
PP1	Parallel poll function, full capability
RL1	Remote/Local switch over function, full capability
DC1	Reset function (Device Clear), full capability
DT1	Trigger function (Device Trigger), full capability

Glossary: List of the Often Used Terms and Abbreviations

Symbols

/hdd: Provided for backward compatibility with R&S SMBV in remote control; internally mapped to `/var/user/`.

A

Absolute file path: [Complete file path](#)

B

Base unit: This term describes a R&S SMBV100B equipped with baseband generator and R&S SMBVB-B103.

Baseband: The baseband signal, i.e. the I/Q stream at the output of the "Baseband" block.

In rear cases, the term Baseband is used as abbreviation of a "Baseband" block itself.

Baseband domain: A common term for signal processing up to the I/Q modulation. The signal in the baseband domain of the R&S SMBV100B is digital.

Baseband(s) Signal: [Baseband](#)

BS: Base station

C

CFast card: CFast card is a type of removable memory storage, that can hold files with user data.

Support of this memory type is optional and requires option R&S SMBVB-B80.

Throughout this description, the CFast card is referred as a removable memory.

This memory cannot be installed if the [mSata](#) card is installed.

See also [System drive](#).

Channel (Digital Input, Digital Output): The signal provided at a digital interface connector or the output stream at the digital output interface may consist of several multiplexed channels. Do not mistake the term *channel* used here with the term signal path. A digital channel is a part of an I/Q stream.

Clock: A mandatory reference clock signal for generating the timing pulse in the instrument.

Complete file path: The complete file path specifies the root directory and all subdirectories that contain a file or folder.

See also [Chapter 12.6.2, "Accessing Files in the Default or in a Specified Directory"](#), on page 588.

Computer name: An unambiguous indication of the instrument a LAN that uses a [DNS](#) server.

The default computer name follows the syntax `SMBV100B-<serial number>`, e.g. `SMBV100B-102030`.

Synonym: [Hostname](#)

See [Serial number](#).

Continuous Wave Mode: [CW/Mod](#)

CW/Mod: An internally generated control signal that turns off/on digital modulation, i.e. the signal is generated in unmodulated form.

D

daisy chain: A connection scheme in which instruments are connected together in sequence, i.e. an output of the first one is connected to an input of the second one, etc.

DHCP: Dynamic Host Configuration Protocol

DNS: Domain Name System server

E

e.g.: For example

F

File transfer: The transmission of files from or to the instrument by a remote client. The instrument supports the standard methods File Transfer Protocol (FTP) and file sharing according to Server Message Protocol (SAMBA/SMB).

Full file path: [Complete file path](#)

G

Glossary: List of the often used terms and abbreviations

GUI: Graphical User Interface

H

Hostname: [Computer name](#)

I

i.e.: That is

I/Q Stream: [Stream](#)

L

Level: In the Baseband domain, a term describing the signal level of the independent I and Q signals during signal processing (e.g. baseband signal leveling, modulation, etc.).

LSB: Least significant bit

M

Marker: User-defined digital signal for synchronizing external devices to the generated data stream.

Do not mistake the term *marker (signal)* used here with the term [Marker \(graphical signal display\)](#).

Marker (graphical signal display): Markers are tools for numerical readout of measured data in diagrams.

Marker signal: [Marker](#)

master-slave: Setup with two or more R&S SMBV100B or one R&S SMBV100B and several other signal generators such as R&S SGT or R&S SMBV that generates synchronous and time aligned signals.

The master instrument generates and outputs a dedicated synchronization signal (Sync Out), that has to be fed into the slave instruments.

See [Chapter 8.3.1, "Connecting Multiple Instruments in Master-Slave Mode"](#), on page 399.

MIMO: Multiple Input Multiple Outputs

mSata: Memory that holds the operating system, the firmware, and used data.

Throughout this description, this memory is referred as an internal memory.

This memory cannot be installed if the CFast card ([removable memory](#)) is installed.

MSB: Most significant bit

MxN: Representation of a [MIMO](#) system, where M is the number of the transmitting Tx antennas and N the number of the receiving Rx antennas.

N

NTP: (Network Time Protocol)

A networking protocol for highly accurate clock synchronization between computer systems and instruments in local area networks, or over the public Internet.

P

PC: Personal computer

PN sequence: [PRBS generator](#)

Power: A term describing the signal level in the RF domain or defining the length of the I/Q vector in the Baseband domain.

PRBS generator: Delivers pseudo-random binary sequences of differing length and duration. They are known as maximum length sequences, and are generated with the aid of ring shift registers with feedback points determined by the polynomial.

product page: A designation of the R&S SMBV100B product page <http://www.rohde-schwarz.com/product/SMBV100B.html>

R

Remote access: [Remote operation](#)

Remote control: The operation of the R&S SMBV100B by remote control commands or programs to perform automated tests. The instrument is connected to a system controller via LAN/VXI-11, GPIB or USB using Virtual Instrument Software Architecture (VISA). The instrument is controlled either directly, or supported by instrument drivers.

Remote device: External device controls the R&S SMBV100B in remote operation mode, see [Remote operation](#).

Synonyms: External controller, Client device,

Remote operation: Allows you to operate the R&S SMBV100B from a remote device via VNC.

Both the R&S SMBV100B and the remote device are connected in a LAN.

Synonym: Remote access

removable memory: General term describing mass memory that can be unmounted from the instrument.

See also [CFast card](#).

RF: Radio Frequency

S

Serial number: Unique instrument identification, provided on the rear panel of the instrument and required to build the [Computer name](#).

The serial number are the last 6 digits in the string `<stock no.>-<serial number>`, e.g. SMBV100B-102030

See [Figure 2-3](#).

SISO: Single Input Single Output

Smart device: A mobile, cordless device, such as a smartphone or tablet, capable of Internet browsing.

Synonyms: Smartphone, Tablet

star configuration: A connection scheme for several instruments that consists of one central instrument and several other instruments, all connected to the central one.

Stream: An I/Q stream describes the signal at the input of the "I/Q Stream Mapper" up to the output connectors of the instrument.

Symbol Clock: Represents the frequency and exact timing of the transmission of the individual symbols

Symbol Rate: Calculated as follows:
"Symbol Rate" = "Bit Rate" / Number of bits transmitted with each symbol

Sync signal: In [master-slave](#) mode, this term describes the signal generated by the master instrument and fed to the slaved.
The synchronization signal is precise signal that facilitates the time alignment between the instruments and acts as trigger signal.

System drive: The system drive is a µSD card that holds the operating system, the firmware, and the user data.
Throughout this description, the system drive is referred as an internal memory.

T

Trigger: Internally generated or externally supplied signal which starts signal generation at a particular point in time.

Trigger event: A trigger event is caused by the received trigger signal or executed manual trigger.

U

UE: User equipment

USBTMC: (USB Test & Measurement Class)

A protocol built on top of USB for communication with USB devices. Using VISA library, it supports service request, triggers, and other specific operations, similar to GPIB.

User directory: Describes the default file storage location for user data.

In the file system, user directory is indicated as `/var/user/`

It is physically located on the internal memory or on the [removable memory](#), if option R&S SMBVB-B80 is installed.

W

Waveform: A file with settings provided for repeatable tests with the same test signal.

List of Commands

:CALibration:ALL[:MEASure]?	599
:CALibration:DATA:FACTory:DATE?	601
:CALibration:ROSCillator[:DATA]	601
:CALibration<hw>:ALL:DATE?	600
:CALibration<hw>:ALL:INFormation?	600
:CALibration<hw>:ALL:TEMP?	600
:CALibration<hw>:ALL:TIME?	601
:CALibration<hw>:IQModulator:FULL?	602
:CALibration<hw>:IQModulator:LOCAl?	602
:CALibration<hw>:LEVel:ALCTable[:MEASure]?	602
:DEVice:PRESet	586
:DIAGnostic<hw>:BGINfo:CATalog?	603
:DIAGnostic<hw>:BGINfo?	604
:DIAGnostic<hw>:POINt:CATalog?	604
:DIAGnostic<hw>[:MEASure]:POINt?	605
:DISPlay:ANNotation:AMPLitude	607
:DISPlay:ANNotation:FREQuency	608
:DISPlay:ANNotation[:ALL]	608
:DISPlay:BRIGhtness	607
:DISPlay:BUtTon:BRIGhtness	607
:DISPlay:DIALog:CLoSe	609
:DISPlay:DIALog:CLoSe:ALL	610
:DISPlay:DIALog:ID?	608
:DISPlay:DIALog:OPEN	609
:DISPlay:PSAVe:HOLDoff	606
:DISPlay:PSAVe[:STATe]	606
:DISPlay:UPDate	607
:FORMat:BOReDer	610
:FORMat:SREGister	611
:FORMat[:DATA]	611
:HCOPy:DATA?	613
:HCOPy:DEVice:LANGUage	613
:HCOPy:FILE[:NAME]	613
:HCOPy:FILE[:NAME]:AUTO:DIRectory	614
:HCOPy:FILE[:NAME]:AUTO:DIRectory:CLear	615
:HCOPy:FILE[:NAME]:AUTO:FILE?	615
:HCOPy:FILE[:NAME]:AUTO:STATe	615
:HCOPy:FILE[:NAME]:AUTO?	614
:HCOPy:FILE[:NAME]:AUTO[:FILE]:DAY:STATe	615
:HCOPy:FILE[:NAME]:AUTO[:FILE]:MONTh:STATe	615
:HCOPy:FILE[:NAME]:AUTO[:FILE]:NUMBer?	616
:HCOPy:FILE[:NAME]:AUTO[:FILE]:PREFix	616
:HCOPy:FILE[:NAME]:AUTO[:FILE]:PREFix:STATe	616
:HCOPy:FILE[:NAME]:AUTO[:FILE]:YEAR:STATe	615
:HCOPy:IMAGe:FORMat	613
:HCOPy:REGion	613
:HCOPy[:EXECute]	614

:INITiate<hw>[:POWer]:CONTinuous.....	624
:KBOard:LAYout.....	617
:MEMory:HFRee?.....	598
:MMEMory:CATalog:LENGth?.....	592
:MMEMory:CATalog?.....	592
:MMEMory:CDIRectory.....	593
:MMEMory:COPI.....	593
:MMEMory:DATA.....	594
:MMEMory:DATA:UNPRotected.....	594
:MMEMory:DCATalog:LENGth?.....	596
:MMEMory:DCATalog?.....	596
:MMEMory:DELeTe.....	597
:MMEMory:LOAD:STATe.....	597
:MMEMory:MDIRectory.....	597
:MMEMory:MOVE.....	597
:MMEMory:MSIS.....	598
:MMEMory:RDIRectory.....	598
:MMEMory:STORe:STATe.....	598
:OUTPut:ALL[:STATe].....	617
:OUTPut:USER<ch>:DIRectioN.....	649
:OUTPut:USER<ch>:SIGNal.....	649
:OUTPut:USER<ch>:TRIGger[:IMMediate].....	650
:OUTPut<hw>:AFIXed:RANGe:LOWer?.....	619
:OUTPut<hw>:AFIXed:RANGe:UPPer?.....	619
:OUTPut<hw>:AMODE.....	618
:OUTPut<hw>:IMPedance?.....	618
:OUTPut<hw>:PROTection:CLear.....	619
:OUTPut<hw>:PROTection:TRIPped?.....	619
:OUTPut<hw>[:STATe].....	618
:OUTPut<hw>[:STATe]:PON.....	618
:READ<ch>[:POWer]?.....	624
:SCONfiguration:EXTErnal:ACONnect.....	637
:SCONfiguration:EXTErnal:DIGital:DIRectioN?.....	639
:SCONfiguration:EXTErnal:DIGital:INAMe?.....	640
:SCONfiguration:EXTErnal:DIGital:IQConnection:STATe?.....	639
:SCONfiguration:EXTErnal:DIGital:RCONnection:STATe?.....	640
:SCONfiguration:EXTErnal:DIGital:REMote:CONNect.....	645
:SCONfiguration:EXTErnal:DIGital:REMote:DETeCt?.....	644
:SCONfiguration:EXTErnal:DIGital:REMote:DISConnect.....	646
:SCONfiguration:EXTErnal:DIGital:REMote:INFO?.....	645
:SCONfiguration:EXTErnal:DIGital:REMote:INITialization:FILE.....	646
:SCONfiguration:EXTErnal:DIGital:REMote:ISELect.....	645
:SCONfiguration:EXTErnal:DIGital:RF:COUPLing.....	640
:SCONfiguration:EXTErnal:DIGital:RF:FREQuency.....	641
:SCONfiguration:EXTErnal:DIGital:RF:FREQuency:OFFSet.....	641
:SCONfiguration:EXTErnal:DIGital:RF:POWer.....	641
:SCONfiguration:EXTErnal:DIGital:RF:POWer:OFFSet.....	642
:SCONfiguration:EXTErnal:DIGital:RF:STATe.....	642
:SCONfiguration:EXTErnal:DISPlay.....	637
:SCONfiguration:EXTErnal:IQOutput:DIRectioN?.....	639

:SCONfiguration:EXTernal:IQOutput:INAME?.....	640
:SCONfiguration:EXTernal:IQOutput:RCONNECTION:STATE?.....	640
:SCONfiguration:EXTernal:IQOutput:REMote:CONNECT.....	645
:SCONfiguration:EXTernal:IQOutput:REMote:DISCONNECT.....	646
:SCONfiguration:EXTernal:IQOutput:REMote:INFO?.....	645
:SCONfiguration:EXTernal:IQOutput:REMote:INITIALIZATION:FILE.....	646
:SCONfiguration:EXTernal:IQOutput:REMote:ISELECT.....	645
:SCONfiguration:EXTernal:IQOutput:RF:COUPLING.....	640
:SCONfiguration:EXTernal:IQOutput:RF:FREQUENCY.....	641
:SCONfiguration:EXTernal:IQOutput:RF:FREQUENCY:OFFSET.....	641
:SCONfiguration:EXTernal:IQOutput:RF:POWER.....	641
:SCONfiguration:EXTernal:IQOutput:RF:POWER:OFFSET.....	642
:SCONfiguration:EXTernal:IQOutput:RF:STATE.....	642
:SCONfiguration:EXTernal:PBEHAVIOUR.....	638
:SCONfiguration:EXTernal:REMote:ADD.....	643
:SCONfiguration:EXTernal:REMote:CLEAN.....	647
:SCONfiguration:EXTernal:REMote:CONNECT[:ALL].....	638
:SCONfiguration:EXTernal:REMote:DISCONNECT[:ALL].....	638
:SCONfiguration:EXTernal:REMote:INITIALIZATION:USER:CATALOG?.....	646
:SCONfiguration:EXTernal:REMote:LIST?.....	643
:SCONfiguration:EXTernal:REMote:PURGE.....	646
:SCONfiguration:EXTernal:REMote:RENAME.....	644
:SCONfiguration:EXTernal:REMote:SCAN.....	643
:SCONfiguration:EXTernal:REMote:SCAN:STATE?.....	643
:SCONfiguration:MULTIinstrument:MODE.....	635
:SCONfiguration:MULTIinstrument:STATE.....	635
:SCONfiguration:MULTIinstrument:TRIGGER:SYNCHRONIZATION?.....	636
:SCONfiguration:OUTPut:MAPPING:IQOutput:STReam<st>:STATE.....	636
:SCONfiguration:OUTPut:MAPPING:RF:STReam<st>:STATE.....	636
:SENSe<ch>:UNIT[:POWER].....	625
:SENSe<ch>[:POWER]:APERture:DEFault:STATE.....	625
:SENSe<ch>[:POWER]:APERture:TIME.....	626
:SENSe<ch>[:POWER]:CORRection:SPDevice:LIST?.....	627
:SENSe<ch>[:POWER]:CORRection:SPDevice:SELEct.....	626
:SENSe<ch>[:POWER]:CORRection:SPDevice:STATE.....	626
:SENSe<ch>[:POWER]:DISPlay:PERManent:PRIOriTy.....	627
:SENSe<ch>[:POWER]:DISPlay:PERManent:STATE.....	627
:SENSe<ch>[:POWER]:FILTer:LENGth:AUTO?.....	627
:SENSe<ch>[:POWER]:FILTer:LENGth[:USER].....	628
:SENSe<ch>[:POWER]:FILTer:NSRatIo.....	628
:SENSe<ch>[:POWER]:FILTer:NSRatIo:MTIME.....	629
:SENSe<ch>[:POWER]:FILTer:SONCe.....	629
:SENSe<ch>[:POWER]:FILTer:TYPE.....	629
:SENSe<ch>[:POWER]:FREQUENCY.....	630
:SENSe<ch>[:POWER]:LOGGing:STATE.....	630
:SENSe<ch>[:POWER]:OFFSet.....	631
:SENSe<ch>[:POWER]:OFFSet:STATE.....	631
:SENSe<ch>[:POWER]:SNUMber?.....	631
:SENSe<ch>[:POWER]:SOURce.....	632
:SENSe<ch>[:POWER]:STATus[:DEVIce]?.....	632

:SENSe<ch>[:POWer]:SVERSion?.....	632
:SENSe<ch>[:POWer]:TYPE?.....	632
:SENSe<ch>[:POWer]:ZERO.....	633
:SLISt:ELEMent<ch>:MAPPing.....	623
:SLISt:SCAN[:STATe].....	623
:SLISt:SENSor:MAP.....	624
:SLISt[:LIST]?.....	623
:SOURce<hw>:PRESet.....	586
:STATus:OPERation:CONDition?.....	907
:STATus:OPERation:ENABLE.....	907
:STATus:OPERation:NTRansition.....	908
:STATus:OPERation:PTRansition.....	908
:STATus:OPERation[:EVENT].....	908
:STATus:PRESet.....	908
:STATus:QUESTionable:CONDition.....	909
:STATus:QUESTionable:ENABLE.....	909
:STATus:QUESTionable:NTRansition.....	909
:STATus:QUESTionable:PTRansition.....	910
:STATus:QUESTionable[:EVENT].....	909
:STATus:QUEEue[:NEXT]?.....	910
:SYSTem:BIOS:VERSion?.....	904
:SYSTem:COMMunicate:GPIB:LTERminator.....	891
:SYSTem:COMMunicate:GPIB:RESource?.....	891
:SYSTem:COMMunicate:GPIB[:SELF]:ADDResS.....	891
:SYSTem:COMMunicate:HISLip:RESource?.....	892
:SYSTem:COMMunicate:NETWork:IPADdress.....	892
:SYSTem:COMMunicate:NETWork:IPADdress:MODE.....	892
:SYSTem:COMMunicate:NETWork:MACAdress.....	892
:SYSTem:COMMunicate:NETWork:RESource?.....	893
:SYSTem:COMMunicate:NETWork:REStart.....	893
:SYSTem:COMMunicate:NETWork:STATus?.....	893
:SYSTem:COMMunicate:NETWork[:COMMOn]:DOMain.....	893
:SYSTem:COMMunicate:NETWork[:COMMOn]:HOSTName.....	893
:SYSTem:COMMunicate:NETWork[:COMMOn]:WORKgrouP.....	894
:SYSTem:COMMunicate:NETWork[:IPADdress]:DNS.....	894
:SYSTem:COMMunicate:NETWork[:IPADdress]:GATeway.....	894
:SYSTem:COMMunicate:NETWork[:IPADdress]:SUBNet:MASK.....	894
:SYSTem:COMMunicate:SERial:BAUD.....	895
:SYSTem:COMMunicate:SERial:PARity.....	895
:SYSTem:COMMunicate:SERial:RESource?.....	895
:SYSTem:COMMunicate:SERial:SBITs.....	895
:SYSTem:COMMunicate:SOCKet:RESource?.....	896
:SYSTem:COMMunicate:USB:RESource?.....	896
:SYSTem:DATE.....	902
:SYSTem:DFPR?.....	905
:SYSTem:DLOCK.....	889
:SYSTem:ERRor:ALL?.....	885
:SYSTem:ERRor:CODE:ALL?.....	885
:SYSTem:ERRor:CODE[:NEXT]?.....	886
:SYSTem:ERRor:COUNt?.....	886

:SYSTem:ERRor:GNEXt?	887
:SYSTem:ERRor:HISTory:CLear	888
:SYSTem:ERRor:HISTory?	887
:SYSTem:ERRor:STATic?	888
:SYSTem:ERRor[:NEXT]?	887
:SYSTem:FILEs:TEMPorary:DELeTe	906
:SYSTem:FPReset	586
:SYSTem:HELP:EXPort	896
:SYSTem:IDENtification	896
:SYSTem:IDENtification:PRESet	897
:SYSTem:INFormaTion:SCPI	898
:SYSTem:IRESpone	897
:SYSTem:KLOCK	889
:SYSTem:LANGUage	898
:SYSTem:MMEMory:PATH:USER?	905
:SYSTem:NTP:HOSTname	903
:SYSTem:NTP:STATe	903
:SYSTem:ORESpone	897
:SYSTem:OSYSem?	905
:SYSTem:PRESet	586
:SYSTem:PROTect<ch>[:STATe]	890
:SYSTem:RCL	889
:SYSTem:REBoot	905
:SYSTem:REStart	906
:SYSTem:SAV	889
:SYSTem:SECurity:SANitizE[:STATe]	898
:SYSTem:SECurity:SUPolicy	899
:SYSTem:SECurity:VOLModE[:STATe]	890
:SYSTem:SHUTdown	906
:SYSTem:SPECification:IDENtification:CATalog?	900
:SYSTem:SPECification:PARAmeter?	901
:SYSTem:SPECification:VERsion	900
:SYSTem:SPECification:VERsion:CATalog?	901
:SYSTem:SPECification:VERsion:FACTory?	901
:SYSTem:SPECification?	899
:SYSTem:SRData?	902
:SYSTem:STARtup:COMPLete?	902
:SYSTem:TIME	903
:SYSTem:TIME:ZONE	904
:SYSTem:TIME:ZONE:CATalog?	904
:SYSTem:ULOCK	888
:SYSTem:UPTime?	904
:SYSTem:VERsion?	904
:SYSTem:WAIT	906
:TEST:BASeband?	911
:TEST:BB:BNC:CONNection?	911
:TEST:BB:BNC:DEStination	912
:TEST:BB:BNC:LOG?	912
:TEST:BB:BNC:SOURce	911
:TEST:BB:BNC:SOURce	912

:TEST:BB:GENerator:ARbitrary.....	913
:TEST:BB:GENerator:FREquency.....	913
:TEST:BB:GENerator:GAIN.....	913
:TEST:BB:GENerator:SOURce.....	914
:TEST:BB:GENerator:STATe.....	914
:TEST<hw>:ALL:RESult?.....	914
:TEST<hw>:ALL:START.....	914
:TRIGger<hw>:FSWeep:SOURce.....	915
:TRIGger<hw>:FSWeep[:IMMEDIATE].....	917
:TRIGger<hw>:LFFSweep.....	917
:TRIGger<hw>:LFFSweep:IMMEDIATE.....	917
:TRIGger<hw>:LFFSweep:SOURce.....	915
:TRIGger<hw>:PSWeep:SOURce.....	915
:TRIGger<hw>:PSWeep[:IMMEDIATE].....	917
:TRIGger<hw>[:SWEep]:SOURce.....	915
:TRIGger<hw>[:SWEep][:IMMEDIATE].....	917
:UNIT:ANGLE.....	918
:UNIT:POWer.....	918
:UNIT:VELocity.....	918
[:SOURce]:BB:GRAPhics:ADD.....	800
[:SOURce]:BB:GRAPhics:CLOSe.....	800
[:SOURce]:BB:GRAPhics:FFTFscale.....	801
[:SOURce]:BB:GRAPhics:FFTLen.....	801
[:SOURce]:BB:GRAPhics:SOURce.....	800
[:SOURce]:BB:IMPairment:IQOutput<ch>:DELay.....	795
[:SOURce]:BB:IMPairment:IQOutput<ch>:IQRatio[:MAGNitude].....	796
[:SOURce]:BB:IMPairment:IQOutput<ch>:LEAKage:I.....	796
[:SOURce]:BB:IMPairment:IQOutput<ch>:LEAKage:Q.....	796
[:SOURce]:BB:IMPairment:IQOutput<ch>:POFFset.....	798
[:SOURce]:BB:IMPairment:IQOutput<ch>:QUADrature[:ANGLE].....	797
[:SOURce]:BB:IMPairment:IQOutput<ch>:SKEW.....	797
[:SOURce]:BB:IMPairment:IQOutput<ch>:STATe.....	798
[:SOURce]:BB:IMPairment:RF<ch>:DELay.....	795
[:SOURce]:BB:IMPairment:RF<ch>:IQRatio[:MAGNitude].....	796
[:SOURce]:BB:IMPairment:RF<ch>:LEAKage:I.....	796
[:SOURce]:BB:IMPairment:RF<ch>:LEAKage:Q.....	796
[:SOURce]:BB:IMPairment:RF<ch>:POFFset.....	798
[:SOURce]:BB:IMPairment:RF<ch>:QUADrature[:ANGLE].....	797
[:SOURce]:BB:IMPairment:RF<ch>:SKEW.....	797
[:SOURce]:BB:IMPairment:RF<ch>:STATe.....	798
[:SOURce]:CORRection:CSET:CATalog?.....	807
[:SOURce]:CORRection:CSET:DELeTe.....	808
[:SOURce]:INPut:TRIGger:SLOPe.....	822
[:SOURce]:INPut:USER:CLOCK:IMPedance.....	651
[:SOURce]:INPut:USER:CLOCK:LEVel.....	650
[:SOURce]:INPut:USER:CLOCK:SLOPe.....	651
[:SOURce]:INPut:USER:PULM:LEVel.....	651
[:SOURce]:INPut:USER:TRIGger:IMPedance.....	651
[:SOURce]:INPut:USER:TRIGger:LEVel.....	650
[:SOURce]:INPut:USER:TRIGger:SLOPe.....	652

[[:SOURce]:INPut:USER<ch>:DIRection.....	649
[[:SOURce]:INPut:USER<ch>:SIGNal.....	649
[[:SOURce]:LFOutput:OFFSet.....	835
[[:SOURce]:LFOutput:SIMPedance.....	835
[[:SOURce]:LFOutput:VOLTage.....	836
[[:SOURce]:LFOutput<ch>:BANDwidth?.....	832
[[:SOURce]:LFOutput<ch>:FREQuency.....	832
[[:SOURce]:LFOutput<ch>:INTernal:VOLTage.....	834
[[:SOURce]:LFOutput<ch>:SOURce.....	835
[[:SOURce]:LFOutput<ch>:SOURce:PATH.....	836
[[:SOURce]:LFOutput<ch>[:STATe].....	834
[[:SOURce]:PM<ch>[:DEViation].....	674
[[:SOURce]:POWer:WIGNore.....	869
[[:SOURce]:PULM[:INTernal][:TRAIIn]:TRIGger:IMMediate.....	676
[[:SOURce]:ROSCillator:EXTernal:FREQuency.....	871
[[:SOURce]:ROSCillator:EXTernal:FREQuency:VARiable.....	871
[[:SOURce]:ROSCillator:EXTernal:MLRange?.....	872
[[:SOURce]:ROSCillator:EXTernal:NSBandwidth?.....	872
[[:SOURce]:ROSCillator:EXTernal:RFOFF[:STATe].....	871
[[:SOURce]:ROSCillator:EXTernal:SBANDwidth.....	872
[[:SOURce]:ROSCillator:OUTPut:ALTErnate:FREQuency:MODE.....	873
[[:SOURce]:ROSCillator:OUTPut:FREQuency:MODE.....	872
[[:SOURce]:ROSCillator:PRESet.....	870
[[:SOURce]:ROSCillator:SOURce.....	870
[[:SOURce]:ROSCillator[:INTernal]:ADJusT:VALue.....	873
[[:SOURce]:ROSCillator[:INTernal]:ADJusT[:STATe].....	874
[[:SOURce<hw>]:AM:DEPTH:SUM.....	664
[[:SOURce<hw>]:AM:DEViation:MODE.....	664
[[:SOURce<hw>]:AM:RATIo.....	664
[[:SOURce<hw>]:AM<ch>:SENSitivity.....	665
[[:SOURce<hw>]:AM<ch>:SOURce.....	663
[[:SOURce<hw>]:AM<ch>:STATe.....	663
[[:SOURce<hw>]:AM<ch>[:DEPTH].....	663
[[:SOURce<hw>]:AWGN:BRATe.....	792
[[:SOURce<hw>]:AWGN:BWIDth.....	790
[[:SOURce<hw>]:AWGN:BWIDth:NOISe?.....	791
[[:SOURce<hw>]:AWGN:BWIDth:RATIo.....	790
[[:SOURce<hw>]:AWGN:CNRatio.....	792
[[:SOURce<hw>]:AWGN:DISP:MODE.....	791
[[:SOURce<hw>]:AWGN:ENRatio.....	792
[[:SOURce<hw>]:AWGN:FREQuency:RESult?.....	794
[[:SOURce<hw>]:AWGN:FREQuency:TARGet.....	794
[[:SOURce<hw>]:AWGN:MODE.....	790
[[:SOURce<hw>]:AWGN:POWer:CARRier.....	792
[[:SOURce<hw>]:AWGN:POWer:MODE.....	791
[[:SOURce<hw>]:AWGN:POWer:NOISe.....	793
[[:SOURce<hw>]:AWGN:POWer:NOISe:TOTal?.....	793
[[:SOURce<hw>]:AWGN:POWer:RMODE.....	791
[[:SOURce<hw>]:AWGN:POWer:SUM:PEP?.....	794
[[:SOURce<hw>]:AWGN:POWer:SUM?.....	793

[:SOURce<hw>]:AWGN:STATe.....	789
[:SOURce<hw>]:BB:ARBitrary:CLOCK.....	723
[:SOURce<hw>]:BB:ARBitrary:CLOCK:SOURce.....	749
[:SOURce<hw>]:BB:ARBitrary:MCARrier:CARRier:COUNT.....	734
[:SOURce<hw>]:BB:ARBitrary:MCARrier:CARRier:MODE.....	734
[:SOURce<hw>]:BB:ARBitrary:MCARrier:CARRier:SPACing.....	734
[:SOURce<hw>]:BB:ARBitrary:MCARrier:CARRier<ch>:CONFLict?.....	740
[:SOURce<hw>]:BB:ARBitrary:MCARrier:CARRier<ch>:DELay.....	740
[:SOURce<hw>]:BB:ARBitrary:MCARrier:CARRier<ch>:FILE.....	740
[:SOURce<hw>]:BB:ARBitrary:MCARrier:CARRier<ch>:FREQUency.....	739
[:SOURce<hw>]:BB:ARBitrary:MCARrier:CARRier<ch>:PHASe.....	739
[:SOURce<hw>]:BB:ARBitrary:MCARrier:CARRier<ch>:POWer.....	739
[:SOURce<hw>]:BB:ARBitrary:MCARrier:CARRier<ch>:STATe.....	738
[:SOURce<hw>]:BB:ARBitrary:MCARrier:CFACTOR:MODE.....	735
[:SOURce<hw>]:BB:ARBitrary:MCARrier:CLIPping:CFACTOR.....	736
[:SOURce<hw>]:BB:ARBitrary:MCARrier:CLIPping:CUTOFF.....	736
[:SOURce<hw>]:BB:ARBitrary:MCARrier:CLIPping[STATe].....	736
[:SOURce<hw>]:BB:ARBitrary:MCARrier:CLOAD.....	737
[:SOURce<hw>]:BB:ARBitrary:MCARrier:CLOCK?.....	738
[:SOURce<hw>]:BB:ARBitrary:MCARrier:CREate.....	738
[:SOURce<hw>]:BB:ARBitrary:MCARrier:EDIT:CARRier:DELay:STEP.....	742
[:SOURce<hw>]:BB:ARBitrary:MCARrier:EDIT:CARRier:DELay[START].....	743
[:SOURce<hw>]:BB:ARBitrary:MCARrier:EDIT:CARRier:EXECute.....	743
[:SOURce<hw>]:BB:ARBitrary:MCARrier:EDIT:CARRier:FILE.....	743
[:SOURce<hw>]:BB:ARBitrary:MCARrier:EDIT:CARRier:PHASe:STEP.....	742
[:SOURce<hw>]:BB:ARBitrary:MCARrier:EDIT:CARRier:PHASe[START].....	742
[:SOURce<hw>]:BB:ARBitrary:MCARrier:EDIT:CARRier:POWer:STEP.....	741
[:SOURce<hw>]:BB:ARBitrary:MCARrier:EDIT:CARRier:POWer[START].....	741
[:SOURce<hw>]:BB:ARBitrary:MCARrier:EDIT:CARRier:START.....	741
[:SOURce<hw>]:BB:ARBitrary:MCARrier:EDIT:CARRier:STATe.....	740
[:SOURce<hw>]:BB:ARBitrary:MCARrier:EDIT:CARRier:STOP.....	741
[:SOURce<hw>]:BB:ARBitrary:MCARrier:OFILe.....	737
[:SOURce<hw>]:BB:ARBitrary:MCARrier:POWer:REFerence.....	737
[:SOURce<hw>]:BB:ARBitrary:MCARrier:PRESet.....	733
[:SOURce<hw>]:BB:ARBitrary:MCARrier:SAMPles?.....	735
[:SOURce<hw>]:BB:ARBitrary:MCARrier:SETTing:CATalog?.....	733
[:SOURce<hw>]:BB:ARBitrary:MCARrier:SETTing:LOAD.....	733
[:SOURce<hw>]:BB:ARBitrary:MCARrier:SETTing:STORE.....	734
[:SOURce<hw>]:BB:ARBitrary:MCARrier:TIME.....	735
[:SOURce<hw>]:BB:ARBitrary:MCARrier:TIME:MODE.....	737
[:SOURce<hw>]:BB:ARBitrary:PRAMP[STATe].....	716
[:SOURce<hw>]:BB:ARBitrary:PRESet.....	716
[:SOURce<hw>]:BB:ARBitrary:SIGNAL:TYPE.....	717
[:SOURce<hw>]:BB:ARBitrary:STATe.....	716
[:SOURce<hw>]:BB:ARBitrary:TRIGger:ARM:EXECute.....	745
[:SOURce<hw>]:BB:ARBitrary:TRIGger:DELay:UNIT.....	746
[:SOURce<hw>]:BB:ARBitrary:TRIGger:EXECute.....	746
[:SOURce<hw>]:BB:ARBitrary:TRIGger:OUTPut<ch>:DELay.....	749
[:SOURce<hw>]:BB:ARBitrary:TRIGger:OUTPut<ch>:MODE.....	748
[:SOURce<hw>]:BB:ARBitrary:TRIGger:OUTPut<ch>:OFFTime.....	748

[:SOURce<hw>]:BB:ARBitrary:TRIGger:OUTPut<ch>:ONTime.....	748
[:SOURce<hw>]:BB:ARBitrary:TRIGger:OUTPut<ch>:PATtern.....	748
[:SOURce<hw>]:BB:ARBitrary:TRIGger:OUTPut<ch>:PULSe:DIVider.....	749
[:SOURce<hw>]:BB:ARBitrary:TRIGger:OUTPut<ch>:PULSe:FREQuency?.....	749
[:SOURce<hw>]:BB:ARBitrary:TRIGger:RMODE?.....	745
[:SOURce<hw>]:BB:ARBitrary:TRIGger:SLENgth.....	745
[:SOURce<hw>]:BB:ARBitrary:TRIGger:SLUNit.....	745
[:SOURce<hw>]:BB:ARBitrary:TRIGger:SMODE.....	728
[:SOURce<hw>]:BB:ARBitrary:TRIGger:SOURce.....	744
[:SOURce<hw>]:BB:ARBitrary:TRIGger[:EXternal]:DELay.....	746
[:SOURce<hw>]:BB:ARBitrary:TRIGger[:EXternal]:INHibit.....	747
[:SOURce<hw>]:BB:ARBitrary:TRIGger[:EXternal]:RDELay?.....	747
[:SOURce<hw>]:BB:ARBitrary:TRIGger[:EXternal]:SYNChronize:OUTPut.....	746
[:SOURce<hw>]:BB:ARBitrary:TRIGger[:EXternal]:TDELay.....	747
[:SOURce<hw>]:BB:ARBitrary:TSIGnal:CIQ:CREate.....	720
[:SOURce<hw>]:BB:ARBitrary:TSIGnal:CIQ:CREate:NAMed.....	720
[:SOURce<hw>]:BB:ARBitrary:TSIGnal:CIQ:I.....	717
[:SOURce<hw>]:BB:ARBitrary:TSIGnal:CIQ:Q.....	717
[:SOURce<hw>]:BB:ARBitrary:TSIGnal:RECTangle:AMPLitude.....	717
[:SOURce<hw>]:BB:ARBitrary:TSIGnal:RECTangle:CREate.....	720
[:SOURce<hw>]:BB:ARBitrary:TSIGnal:RECTangle:CREate:NAMed.....	720
[:SOURce<hw>]:BB:ARBitrary:TSIGnal:RECTangle:FREQuency.....	718
[:SOURce<hw>]:BB:ARBitrary:TSIGnal:RECTangle:OFFSet.....	718
[:SOURce<hw>]:BB:ARBitrary:TSIGnal:RECTangle:SAMPles.....	718
[:SOURce<hw>]:BB:ARBitrary:TSIGnal:SINE:CREate.....	720
[:SOURce<hw>]:BB:ARBitrary:TSIGnal:SINE:CREate:NAMed.....	720
[:SOURce<hw>]:BB:ARBitrary:TSIGnal:SINE:FREQuency.....	719
[:SOURce<hw>]:BB:ARBitrary:TSIGnal:SINE:PHASe.....	719
[:SOURce<hw>]:BB:ARBitrary:TSIGnal:SINE:SAMPles.....	719
[:SOURce<hw>]:BB:ARBitrary:WAVEform:CATalog:LENGth?.....	721
[:SOURce<hw>]:BB:ARBitrary:WAVEform:CATalog?.....	720
[:SOURce<hw>]:BB:ARBitrary:WAVEform:CLOCK.....	724
[:SOURce<hw>]:BB:ARBitrary:WAVEform:DATA.....	722
[:SOURce<hw>]:BB:ARBitrary:WAVEform:DELete.....	721
[:SOURce<hw>]:BB:ARBitrary:WAVEform:FREE?.....	721
[:SOURce<hw>]:BB:ARBitrary:WAVEform:POINts?.....	722
[:SOURce<hw>]:BB:ARBitrary:WAVEform:SElect.....	721
[:SOURce<hw>]:BB:ARBitrary:WAVEform:TAG?.....	723
[:SOURce<hw>]:BB:ARBitrary:WSEGment:CLOAd.....	728
[:SOURce<hw>]:BB:ARBitrary:WSEGment:CONFigure:BLANK:APPend.....	729
[:SOURce<hw>]:BB:ARBitrary:WSEGment:CONFigure:CATalog?.....	730
[:SOURce<hw>]:BB:ARBitrary:WSEGment:CONFigure:CLOCK.....	730
[:SOURce<hw>]:BB:ARBitrary:WSEGment:CONFigure:CLOCK:MODE.....	730
[:SOURce<hw>]:BB:ARBitrary:WSEGment:CONFigure:COMMENT.....	731
[:SOURce<hw>]:BB:ARBitrary:WSEGment:CONFigure:DELete.....	731
[:SOURce<hw>]:BB:ARBitrary:WSEGment:CONFigure:LEVel[:MODE].....	730
[:SOURce<hw>]:BB:ARBitrary:WSEGment:CONFigure:MARKer:ESEGment.....	728
[:SOURce<hw>]:BB:ARBitrary:WSEGment:CONFigure:MARKer:FSEGment.....	728
[:SOURce<hw>]:BB:ARBitrary:WSEGment:CONFigure:MARKer:MODE.....	728
[:SOURce<hw>]:BB:ARBitrary:WSEGment:CONFigure:OFILe.....	731

[:SOURce<hw>]:BB:ARBitrary:WSEGment:CONFIgure:SEGMENT:APPend.....	731
[:SOURce<hw>]:BB:ARBitrary:WSEGment:CONFIgure:SEGMENT:CATalog?.....	726
[:SOURce<hw>]:BB:ARBitrary:WSEGment:CONFIgure:SELEct.....	732
[:SOURce<hw>]:BB:ARBitrary:WSEGment:CREate.....	727
[:SOURce<hw>]:BB:ARBitrary:WSEGment:LMODe.....	726
[:SOURce<hw>]:BB:ARBitrary:WSEGment:NAME?.....	725
[:SOURce<hw>]:BB:ARBitrary:WSEGment:NEXT.....	725
[:SOURce<hw>]:BB:ARBitrary:WSEGment:NEXT:EXECute.....	725
[:SOURce<hw>]:BB:ARBitrary:WSEGment:NEXT:SOURce.....	726
[:SOURce<hw>]:BB:ARBitrary:WSEGment:SEQuence:APPend.....	727
[:SOURce<hw>]:BB:ARBitrary:WSEGment:SEQuence:SELEct.....	726
[:SOURce<hw>]:BB:ARBitrary:WSEGment?.....	725
[:SOURce<hw>]:BB:ARBitrary[:TRIGger]:SEQuence.....	744
[:SOURce<hw>]:BB:CFACtor?.....	682
[:SOURce<hw>]:BB:DM:APSK16:GAMMa.....	693
[:SOURce<hw>]:BB:DM:APSK32:GAMMa.....	693
[:SOURce<hw>]:BB:DM:AQPSk:ANGLE.....	691
[:SOURce<hw>]:BB:DM:ASK:DEPTh.....	692
[:SOURce<hw>]:BB:DM:CLISt:CATalog?.....	701
[:SOURce<hw>]:BB:DM:CLISt:COPIY.....	705
[:SOURce<hw>]:BB:DM:CLISt:DATA.....	705
[:SOURce<hw>]:BB:DM:CLISt:DELEte.....	703
[:SOURce<hw>]:BB:DM:CLISt:FREE?.....	703
[:SOURce<hw>]:BB:DM:CLISt:POINts?.....	704
[:SOURce<hw>]:BB:DM:CLISt:SELEct.....	702
[:SOURce<hw>]:BB:DM:CLISt:TAG?.....	707
[:SOURce<hw>]:BB:DM:CLOCK:SOURce.....	701
[:SOURce<hw>]:BB:DM:CODing.....	690
[:SOURce<hw>]:BB:DM:DLISt:CATalog?.....	701
[:SOURce<hw>]:BB:DM:DLISt:COPIY.....	705
[:SOURce<hw>]:BB:DM:DLISt:DATA.....	706
[:SOURce<hw>]:BB:DM:DLISt:DATA:APPend.....	707
[:SOURce<hw>]:BB:DM:DLISt:DELEte.....	703
[:SOURce<hw>]:BB:DM:DLISt:FREE?.....	703
[:SOURce<hw>]:BB:DM:DLISt:POINts.....	704
[:SOURce<hw>]:BB:DM:DLISt:SELEct.....	702
[:SOURce<hw>]:BB:DM:DLISt:TAG?.....	707
[:SOURce<hw>]:BB:DM:FILTer:PARAmeter:APCO25.....	689
[:SOURce<hw>]:BB:DM:FILTer:PARAmeter:APCO25Lsm:GAUSS.....	689
[:SOURce<hw>]:BB:DM:FILTer:PARAmeter:APCO25Lsm:LOWPass.....	689
[:SOURce<hw>]:BB:DM:FILTer:PARAmeter:COSSine:BANDwidth.....	689
[:SOURce<hw>]:BB:DM:FILTer:PARAmeter:COSSine[:ROLLoff].....	689
[:SOURce<hw>]:BB:DM:FILTer:PARAmeter:GAUSS.....	689
[:SOURce<hw>]:BB:DM:FILTer:PARAmeter:LPASS.....	689
[:SOURce<hw>]:BB:DM:FILTer:PARAmeter:LPASSEVM.....	689
[:SOURce<hw>]:BB:DM:FILTer:PARAmeter:PGAuss.....	689
[:SOURce<hw>]:BB:DM:FILTer:PARAmeter:RCOSSine.....	689
[:SOURce<hw>]:BB:DM:FILTer:PARAmeter:SPHase.....	689
[:SOURce<hw>]:BB:DM:FILTer:TYPE.....	689
[:SOURce<hw>]:BB:DM:FLISt:CATalog?.....	701

[[:SOURce<hw>]:BB:DM:FLISt:DELeTe.....	703
[[:SOURce<hw>]:BB:DM:FLISt:FRee?.....	703
[[:SOURce<hw>]:BB:DM:FLISt:POINts?.....	704
[[:SOURce<hw>]:BB:DM:FLISt:SELeCt.....	702
[[:SOURce<hw>]:BB:DM:FORMat.....	691
[[:SOURce<hw>]:BB:DM:FSK:DEVIation.....	692
[[:SOURce<hw>]:BB:DM:FSK:VARiable:SYMBol<ch0>:DEVIation.....	692
[[:SOURce<hw>]:BB:DM:FSK:VARiable:TYPE.....	693
[[:SOURce<hw>]:BB:DM:MLISt:CATalog?.....	701
[[:SOURce<hw>]:BB:DM:MLISt:DELeTe.....	703
[[:SOURce<hw>]:BB:DM:MLISt:FRee?.....	703
[[:SOURce<hw>]:BB:DM:MLISt:POINts?.....	704
[[:SOURce<hw>]:BB:DM:MLISt:SELeCt.....	702
[[:SOURce<hw>]:BB:DM:PATTeRn.....	687
[[:SOURce<hw>]:BB:DM:PRAMp:ATTenuation.....	695
[[:SOURce<hw>]:BB:DM:PRAMp:BBONly[:STATe].....	695
[[:SOURce<hw>]:BB:DM:PRAMp:FDELay.....	694
[[:SOURce<hw>]:BB:DM:PRAMp:RDELay.....	694
[[:SOURce<hw>]:BB:DM:PRAMp:SHAPE.....	694
[[:SOURce<hw>]:BB:DM:PRAMp:SOURce.....	694
[[:SOURce<hw>]:BB:DM:PRAMp:TIME.....	694
[[:SOURce<hw>]:BB:DM:PRAMp[:STATe].....	695
[[:SOURce<hw>]:BB:DM:PRBS[:LENGth].....	687
[[:SOURce<hw>]:BB:DM:PRESet.....	686
[[:SOURce<hw>]:BB:DM:SETTing:CATalog?.....	687
[[:SOURce<hw>]:BB:DM:SETTing:DELeTe.....	689
[[:SOURce<hw>]:BB:DM:SETTing:LOAD.....	688
[[:SOURce<hw>]:BB:DM:SETTing:STORe.....	688
[[:SOURce<hw>]:BB:DM:SOURce.....	686
[[:SOURce<hw>]:BB:DM:SRATe.....	686
[[:SOURce<hw>]:BB:DM:STANdard.....	686
[[:SOURce<hw>]:BB:DM:STANdard:ULISt:CATalog?.....	687
[[:SOURce<hw>]:BB:DM:STANdard:ULISt:DELeTe.....	689
[[:SOURce<hw>]:BB:DM:STANdard:ULISt:LOAD.....	688
[[:SOURce<hw>]:BB:DM:STANdard:ULISt:STORe.....	688
[[:SOURce<hw>]:BB:DM:STATe.....	685
[[:SOURce<hw>]:BB:DM:SWITChing:STATe.....	693
[[:SOURce<hw>]:BB:DM:TRIGger:ARM:EXECute.....	697
[[:SOURce<hw>]:BB:DM:TRIGger:DELay:UNIT.....	698
[[:SOURce<hw>]:BB:DM:TRIGger:EXECute.....	697
[[:SOURce<hw>]:BB:DM:TRIGger:EXTeRnal:SYNChronize:OUTPut.....	697
[[:SOURce<hw>]:BB:DM:TRIGger:OUTPut<ch>:DELay.....	701
[[:SOURce<hw>]:BB:DM:TRIGger:OUTPut<ch>:MODE.....	699
[[:SOURce<hw>]:BB:DM:TRIGger:OUTPut<ch>:OFFTime.....	700
[[:SOURce<hw>]:BB:DM:TRIGger:OUTPut<ch>:ONTime.....	700
[[:SOURce<hw>]:BB:DM:TRIGger:OUTPut<ch>:PATTeRn.....	700
[[:SOURce<hw>]:BB:DM:TRIGger:OUTPut<ch>:PULSe:DIVider.....	700
[[:SOURce<hw>]:BB:DM:TRIGger:OUTPut<ch>:PULSe:FREQuency?.....	700
[[:SOURce<hw>]:BB:DM:TRIGger:RMODE?.....	697
[[:SOURce<hw>]:BB:DM:TRIGger:SLENgth.....	696

[:SOURce<hw>]:BB:DM:TRIGger:SOURce.....	696
[:SOURce<hw>]:BB:DM:TRIGger[:EXternal]:DELay.....	698
[:SOURce<hw>]:BB:DM:TRIGger[:EXternal]:INHibit.....	699
[:SOURce<hw>]:BB:DM:TRIGger[:EXternal]:RDELay?.....	699
[:SOURce<hw>]:BB:DM:TRIGger[:EXternal]:TDELay.....	698
[:SOURce<hw>]:BB:DM[:TRIGger]:SEQuence.....	696
[:SOURce<hw>]:BB:FOFFset.....	680
[:SOURce<hw>]:BB:GRAPhics:MODE.....	799
[:SOURce<hw>]:BB:GRAPhics:SRATe:MODE.....	799
[:SOURce<hw>]:BB:GRAPhics:SRATe:USER.....	800
[:SOURce<hw>]:BB:GRAPhics:TRIGger:SOURce.....	801
[:SOURce<hw>]:BB:IMPairment:OPTimization:MODE.....	798
[:SOURce<hw>]:BB:IQGain.....	823
[:SOURce<hw>]:BB:MCCW:CARRier:COUNT.....	776
[:SOURce<hw>]:BB:MCCW:CARRier:LIST:PHASe.....	779
[:SOURce<hw>]:BB:MCCW:CARRier:LIST:POWer.....	780
[:SOURce<hw>]:BB:MCCW:CARRier:LIST:STATe.....	778
[:SOURce<hw>]:BB:MCCW:CARRier:PHASe.....	779
[:SOURce<hw>]:BB:MCCW:CARRier:POWer.....	780
[:SOURce<hw>]:BB:MCCW:CARRier:SPACing.....	777
[:SOURce<hw>]:BB:MCCW:CARRier:STATe.....	778
[:SOURce<hw>]:BB:MCCW:CFACTor.....	777
[:SOURce<hw>]:BB:MCCW:CFACTor:ACTual?.....	778
[:SOURce<hw>]:BB:MCCW:CFACTor:MODE.....	777
[:SOURce<hw>]:BB:MCCW:CLOCK:SOURce.....	787
[:SOURce<hw>]:BB:MCCW:CLOCK?.....	777
[:SOURce<hw>]:BB:MCCW:EDIT:CARRier:EXECute.....	782
[:SOURce<hw>]:BB:MCCW:EDIT:CARRier:PHASe:STEP.....	781
[:SOURce<hw>]:BB:MCCW:EDIT:CARRier:PHASe[:START].....	781
[:SOURce<hw>]:BB:MCCW:EDIT:CARRier:POWer:STEP.....	781
[:SOURce<hw>]:BB:MCCW:EDIT:CARRier:POWer[:START].....	781
[:SOURce<hw>]:BB:MCCW:EDIT:CARRier:START.....	782
[:SOURce<hw>]:BB:MCCW:EDIT:CARRier:STATe.....	782
[:SOURce<hw>]:BB:MCCW:EDIT:CARRier:STOP.....	782
[:SOURce<hw>]:BB:MCCW:PRESet.....	776
[:SOURce<hw>]:BB:MCCW:STATe.....	776
[:SOURce<hw>]:BB:MCCW:TRIGger:ARM:EXECute.....	782
[:SOURce<hw>]:BB:MCCW:TRIGger:EXECute.....	783
[:SOURce<hw>]:BB:MCCW:TRIGger:EXternal:SYNChronize:OUTPut.....	783
[:SOURce<hw>]:BB:MCCW:TRIGger:OUTPut<ch>:DELay.....	786
[:SOURce<hw>]:BB:MCCW:TRIGger:OUTPut<ch>:MODE.....	785
[:SOURce<hw>]:BB:MCCW:TRIGger:OUTPut<ch>:OFFTime.....	785
[:SOURce<hw>]:BB:MCCW:TRIGger:OUTPut<ch>:ONTime.....	785
[:SOURce<hw>]:BB:MCCW:TRIGger:OUTPut<ch>:PATtern.....	786
[:SOURce<hw>]:BB:MCCW:TRIGger:OUTPut<ch>:PULSe:DIVider.....	786
[:SOURce<hw>]:BB:MCCW:TRIGger:OUTPut<ch>:PULSe:FREQUency?.....	786
[:SOURce<hw>]:BB:MCCW:TRIGger:RMODE?.....	783
[:SOURce<hw>]:BB:MCCW:TRIGger:SLENgth.....	783
[:SOURce<hw>]:BB:MCCW:TRIGger:SOURce.....	784
[:SOURce<hw>]:BB:MCCW:TRIGger[:EXternal]:DELay.....	784

[:SOURce<hw>]:BB:MCCW:TRIGger[:EXternal]:INHibit.....	784
[:SOURce<hw>]:BB:MCCW[:TRIGger]:SEQuence.....	785
[:SOURce<hw>]:BB:POFFset.....	681
[:SOURce<hw>]:BB:POWer:PEAK?.....	682
[:SOURce<hw>]:BB:POWer:RMS?.....	682
[:SOURce<hw>]:BB:PROGress:MCODer:ARBitrary:MCARrier?.....	802
[:SOURce<hw>]:BB:PROGress:MCODer:ARBitrary:WSEgment?.....	802
[:SOURce<hw>]:BB:PROGress:MCODer?.....	802
[:SOURce<hw>]:BB:ROUte.....	681
[:SOURce<hw>]:BBIN:ALEVel:EXECute.....	658
[:SOURce<hw>]:BBIN:CDEvice?.....	659
[:SOURce<hw>]:BBIN:CHANnel<ch0>:BB.....	654
[:SOURce<hw>]:BBIN:CHANnel<ch0>:BB:STATe.....	655
[:SOURce<hw>]:BBIN:CHANnel<ch0>:NAME.....	655
[:SOURce<hw>]:BBIN:CHANnel<ch0>:POWer:CFACtor.....	655
[:SOURce<hw>]:BBIN:CHANnel<ch0>:POWer:PEAK.....	655
[:SOURce<hw>]:BBIN:CHANnel<ch0>:POWer:RMS.....	656
[:SOURce<hw>]:BBIN:CHANnel<ch0>:SRATe.....	656
[:SOURce<hw>]:BBIN:DIGital:ASETting:STATe.....	657
[:SOURce<hw>]:BBIN:DIGital:INTerface.....	654
[:SOURce<hw>]:BBIN:DIGital:SOURce.....	654
[:SOURce<hw>]:BBIN:FOFFset.....	680
[:SOURce<hw>]:BBIN:MODE.....	657
[:SOURce<hw>]:BBIN:MPERiod.....	658
[:SOURce<hw>]:BBIN:POFFset.....	681
[:SOURce<hw>]:BBIN:POWer:CFACtor.....	658
[:SOURce<hw>]:BBIN:POWer:PEAK.....	658
[:SOURce<hw>]:BBIN:POWer:RMS?.....	659
[:SOURce<hw>]:BBIN:ROUte.....	681
[:SOURce<hw>]:BBIN:SRATe:MAX?.....	656
[:SOURce<hw>]:BBIN:SRATe:SOURce.....	657
[:SOURce<hw>]:BBIN:SRATe:SUM?.....	656
[:SOURce<hw>]:BBIN:SRATe[:ACTual]?.....	657
[:SOURce<hw>]:BBIN:STATe.....	654
[:SOURce<hw>]:CORRection:CSET:DATA:FREQUency.....	805
[:SOURce<hw>]:CORRection:CSET:DATA:FREQUency:POINts?.....	806
[:SOURce<hw>]:CORRection:CSET:DATA:POWer.....	805
[:SOURce<hw>]:CORRection:CSET:DATA:POWer:POINts?.....	806
[:SOURce<hw>]:CORRection:CSET:DATA[:SENSor<ch>][:POWer]:SONCe.....	806
[:SOURce<hw>]:CORRection:CSET:DATA[:SENSor<ch>][:POWer]:SONCe.....	807
[:SOURce<hw>]:CORRection:CSET[:SELection].....	806
[:SOURce<hw>]:CORRection:DEXChange:AFILe:CATalog?.....	808
[:SOURce<hw>]:CORRection:DEXChange:AFILe:EXTension.....	808
[:SOURce<hw>]:CORRection:DEXChange:AFILe:SELection.....	809
[:SOURce<hw>]:CORRection:DEXChange:AFILe:SEParator:COLumn.....	809
[:SOURce<hw>]:CORRection:DEXChange:AFILe:SEParator:DECimal.....	809
[:SOURce<hw>]:CORRection:DEXChange:EXECute.....	809
[:SOURce<hw>]:CORRection:DEXChange:MODE.....	810
[:SOURce<hw>]:CORRection:DEXChange:SELection.....	810
[:SOURce<hw>]:CORRection:FRESponse:RF:OPTimization:BANDwidth:MODE.....	811

[SOURce<hw>]:CORRection:FRESponse:RF:OPTimization:BANDwidth[:VALue]	811
[SOURce<hw>]:CORRection:FRESponse:RF:OPTimization:LOCAl	812
[SOURce<hw>]:CORRection:FRESponse:RF:OPTimization:MODE	810
[SOURce<hw>]:CORRection:VALue?	806
[SOURce<hw>]:CORRection:ZERoing:STATe	807
[SOURce<hw>]:CORRection[:STATe]	807
[SOURce<hw>]:DM:FILTer:PARAmeter	690
[SOURce<hw>]:FM:DEViation:MODE	668
[SOURce<hw>]:FM:DEViation:SUM	668
[SOURce<hw>]:FM:MODE	669
[SOURce<hw>]:FM:RATIo	669
[SOURce<hw>]:FM:SENSitivity?	669
[SOURce<hw>]:FM<ch>:SOURce	668
[SOURce<hw>]:FM<ch>:STATe	667
[SOURce<hw>]:FM<ch>[:DEViation]	667
[SOURce<hw>]:FREQuency:CENTer	819
[SOURce<hw>]:FREQuency:LOSCillator:INPut:FREQuency?	814
[SOURce<hw>]:FREQuency:LOSCillator:MODE	815
[SOURce<hw>]:FREQuency:LOSCillator:OUTPut:FREQuency?	815
[SOURce<hw>]:FREQuency:LOSCillator:OUTPut:STATe	815
[SOURce<hw>]:FREQuency:MANual	817
[SOURce<hw>]:FREQuency:MODE	815
[SOURce<hw>]:FREQuency:MULTIplier	818
[SOURce<hw>]:FREQuency:OFFSet	818
[SOURce<hw>]:FREQuency:SPAN	819
[SOURce<hw>]:FREQuency:STARt	819
[SOURce<hw>]:FREQuency:STEP:MODE	820
[SOURce<hw>]:FREQuency:STEP[:INCRement]	821
[SOURce<hw>]:FREQuency:STOP	820
[SOURce<hw>]:FREQuency[:CW FIXed]	816
[SOURce<hw>]:FREQuency[:CW FIXed]:RCL	817
[SOURce<hw>]:INPut:MODext:COUPling	821
[SOURce<hw>]:INPut:MODext:IMPedance<ch>	821
[SOURce<hw>]:IQ:CREStfactor	823
[SOURce<hw>]:IQ:GAIN	823
[SOURce<hw>]:IQ:IMPairment:IQRatio[:MAGNitude]	796
[SOURce<hw>]:IQ:IMPairment:LEAKage:I	796
[SOURce<hw>]:IQ:IMPairment:LEAKage:Q	796
[SOURce<hw>]:IQ:IMPairment:QUADrature[:ANGLe]	797
[SOURce<hw>]:IQ:IMPairment[:STATe]	798
[SOURce<hw>]:IQ:OUTPut:ANALog:STATe	825
[SOURce<hw>]:IQ:OUTPut:LEVel	827
[SOURce<hw>]:IQ:OUTPut[:ANALog]:BIAS:COUPling[:STATe]	828
[SOURce<hw>]:IQ:OUTPut[:ANALog]:BIAS:I	828
[SOURce<hw>]:IQ:OUTPut[:ANALog]:BIAS:Q	828
[SOURce<hw>]:IQ:OUTPut[:ANALog]:MODE	827
[SOURce<hw>]:IQ:OUTPut[:ANALog]:OFFSet:I	828
[SOURce<hw>]:IQ:OUTPut[:ANALog]:OFFSet:Q	828
[SOURce<hw>]:IQ:OUTPut[:ANALog]:POWer:DATTenuation	829
[SOURce<hw>]:IQ:OUTPut[:ANALog]:PRESet	826

[:SOURce<hw>]:IQ:OUTPut[:ANALog]:SETTing:CATalog?	826
[:SOURce<hw>]:IQ:OUTPut[:ANALog]:SETTing:DELeTe	827
[:SOURce<hw>]:IQ:OUTPut[:ANALog]:SETTing:LOAD	826
[:SOURce<hw>]:IQ:OUTPut[:ANALog]:SETTing:STORe	826
[:SOURce<hw>]:IQ:OUTPut[:ANALog]:TYPE	827
[:SOURce<hw>]:IQ:SOURce	822
[:SOURce<hw>]:IQ:STATe	823
[:SOURce<hw>]:IQ:SWAP[:STATe]	824
[:SOURce<hw>]:IQ:WBSTate	824
[:SOURce<hw>]:LFOutput:FREQUency:MANual	833
[:SOURce<hw>]:LFOutput:FREQUency:MODE	833
[:SOURce<hw>]:LFOutput:FREQUency:STARt	834
[:SOURce<hw>]:LFOutput:FREQUency:STOP	834
[:SOURce<hw>]:LFOutput:SWEep[:FREQUency]:DWELI	839
[:SOURce<hw>]:LFOutput:SWEep[:FREQUency]:EXECute	839
[:SOURce<hw>]:LFOutput:SWEep[:FREQUency]:MODE	840
[:SOURce<hw>]:LFOutput:SWEep[:FREQUency]:POINts	840
[:SOURce<hw>]:LFOutput:SWEep[:FREQUency]:RETRace	840
[:SOURce<hw>]:LFOutput:SWEep[:FREQUency]:RUNNing?	841
[:SOURce<hw>]:LFOutput:SWEep[:FREQUency]:SHApe	841
[:SOURce<hw>]:LFOutput:SWEep[:FREQUency]:SPACing	841
[:SOURce<hw>]:LFOutput:SWEep[:FREQUency]:STEP:LOGarithmic	841
[:SOURce<hw>]:LFOutput:SWEep[:FREQUency]:STEP[:LINear]	842
[:SOURce<hw>]:LFOutput<ch>:PERiod?	832
[:SOURce<hw>]:LFOutput<ch>:SHApe	836
[:SOURce<hw>]:LFOutput<ch>:SHApe:PULSe:DCYCLe	836
[:SOURce<hw>]:LFOutput<ch>:SHApe:PULSe:PERiod	837
[:SOURce<hw>]:LFOutput<ch>:SHApe:PULSe:WIDTh	837
[:SOURce<hw>]:LFOutput<ch>:SHApe:TRAPeZe:FALL	837
[:SOURce<hw>]:LFOutput<ch>:SHApe:TRAPeZe:HIGH	837
[:SOURce<hw>]:LFOutput<ch>:SHApe:TRAPeZe:PERiod	838
[:SOURce<hw>]:LFOutput<ch>:SHApe:TRAPeZe:RISE	838
[:SOURce<hw>]:LFOutput<ch>:SHApe:TRIangle:PERiod	838
[:SOURce<hw>]:LFOutput<ch>:SHApe:TRIangle:RISE	838
[:SOURce<hw>]:LIST:CATalog?	851
[:SOURce<hw>]:LIST:DELeTe	851
[:SOURce<hw>]:LIST:DELeTe:ALL	851
[:SOURce<hw>]:LIST:DEXChange:AFILe:CATalog?	853
[:SOURce<hw>]:LIST:DEXChange:AFILe:EXTension	854
[:SOURce<hw>]:LIST:DEXChange:AFILe:SELeCt	854
[:SOURce<hw>]:LIST:DEXChange:AFILe:SEParator:COLumn	854
[:SOURce<hw>]:LIST:DEXChange:AFILe:SEParator:DECimal	854
[:SOURce<hw>]:LIST:DEXChange:EXECute	853
[:SOURce<hw>]:LIST:DEXChange:MODE	855
[:SOURce<hw>]:LIST:DEXChange:SELeCt	855
[:SOURce<hw>]:LIST:DWELI	845
[:SOURce<hw>]:LIST:DWELI:LIST	846
[:SOURce<hw>]:LIST:DWELI:LIST:POINts?	846
[:SOURce<hw>]:LIST:DWELI:MODE	846
[:SOURce<hw>]:LIST:FREE?	852

[[:SOURce<hw>]:LIST:FREQUency.....	847
[[:SOURce<hw>]:LIST:FREQUency:POINts?.....	847
[[:SOURce<hw>]:LIST:INDex.....	847
[[:SOURce<hw>]:LIST:INDex:STARt.....	848
[[:SOURce<hw>]:LIST:INDex:STOP.....	848
[[:SOURce<hw>]:LIST:MODE.....	848
[[:SOURce<hw>]:LIST:POWer.....	848
[[:SOURce<hw>]:LIST:POWer:POINts?.....	849
[[:SOURce<hw>]:LIST:RESet.....	852
[[:SOURce<hw>]:LIST:RMODE.....	849
[[:SOURce<hw>]:LIST:RUNNing?.....	850
[[:SOURce<hw>]:LIST:SElect.....	852
[[:SOURce<hw>]:LIST:TRIGger:EXECute.....	849
[[:SOURce<hw>]:LIST:TRIGger:SOURce.....	850
[[:SOURce<hw>]:MODulation[:ALL][::STATe].....	660
[[:SOURce<hw>]:NOISe:Bandwidth BWIDTH.....	856
[[:SOURce<hw>]:NOISe:BWIDth:STATe.....	856
[[:SOURce<hw>]:NOISe:DIStribution.....	856
[[:SOURce<hw>]:NOISe:LEVel:RELative?.....	856
[[:SOURce<hw>]:NOISe:LEVel[:ABSolute]?.....	857
[[:SOURce<hw>]:PGENERator:OUTPut:POLarity.....	857
[[:SOURce<hw>]:PGENERator:OUTPut[::STATe].....	858
[[:SOURce<hw>]:PGENERator:STATe.....	858
[[:SOURce<hw>]:PHASe.....	859
[[:SOURce<hw>]:PHASe:REFerence.....	859
[[:SOURce<hw>]:PM:DEVIation:MODE.....	673
[[:SOURce<hw>]:PM:DEVIation:SUM.....	673
[[:SOURce<hw>]:PM:MODE.....	672
[[:SOURce<hw>]:PM:RATio.....	673
[[:SOURce<hw>]:PM:SENSitivity?.....	674
[[:SOURce<hw>]:PM<ch>:SOURce.....	672
[[:SOURce<hw>]:PM<ch>:STATe.....	671
[[:SOURce<hw>]:POWer:ALC:DSensitivity.....	861
[[:SOURce<hw>]:POWer:ALC:SLEVel.....	862
[[:SOURce<hw>]:POWer:ALC:SONCe.....	861
[[:SOURce<hw>]:POWer:ALC[::STATe].....	860
[[:SOURce<hw>]:POWer:ATTenuation:DIGital.....	862
[[:SOURce<hw>]:POWer:ATTenuation:RFOff:MODE.....	862
[[:SOURce<hw>]:POWer:EMF:STATe.....	863
[[:SOURce<hw>]:POWer:LBEHaviour.....	863
[[:SOURce<hw>]:POWer:LIMit[::AMPLitude].....	863
[[:SOURce<hw>]:POWer:LMODE.....	864
[[:SOURce<hw>]:POWer:MANual.....	864
[[:SOURce<hw>]:POWer:MODE.....	864
[[:SOURce<hw>]:POWer:PEP?.....	865
[[:SOURce<hw>]:POWer:POWer.....	865
[[:SOURce<hw>]:POWer:RANGe:LOWer?.....	869
[[:SOURce<hw>]:POWer:RANGe:UPPer?.....	869
[[:SOURce<hw>]:POWer:STARt.....	866
[[:SOURce<hw>]:POWer:STEP:MODE.....	866

[[:SOURce<hw>]:POWER:STEP[:INCRement].....	867
[[:SOURce<hw>]:POWER:STOP.....	866
[[:SOURce<hw>]:POWER[:LEVel][:IMMediate]:OFFSet.....	867
[[:SOURce<hw>]:POWER[:LEVel][:IMMediate]:RCL.....	868
[[:SOURce<hw>]:POWER[:LEVel][:IMMediate]][:AMPLitude].....	868
[[:SOURce<hw>]:PULM:DELay.....	677
[[:SOURce<hw>]:PULM:DOUBle:DELay.....	677
[[:SOURce<hw>]:PULM:DOUBle:STATe.....	678
[[:SOURce<hw>]:PULM:DOUBle:WIDTh.....	678
[[:SOURce<hw>]:PULM:IMPedance.....	679
[[:SOURce<hw>]:PULM:MODE.....	676
[[:SOURce<hw>]:PULM:OUTPut:VIDeo:POLarity.....	679
[[:SOURce<hw>]:PULM:PERiod.....	677
[[:SOURce<hw>]:PULM:POLarity.....	679
[[:SOURce<hw>]:PULM:SOURce.....	678
[[:SOURce<hw>]:PULM:STATe.....	678
[[:SOURce<hw>]:PULM:TRIGger:MODE.....	676
[[:SOURce<hw>]:PULM:TTYPe.....	678
[[:SOURce<hw>]:PULM:WIDTh.....	677
[[:SOURce<hw>]:SWEep:POWER:DWELI.....	877
[[:SOURce<hw>]:SWEep:POWER:EXECute.....	880
[[:SOURce<hw>]:SWEep:POWER:MODE.....	877
[[:SOURce<hw>]:SWEep:POWER:POINts.....	877
[[:SOURce<hw>]:SWEep:POWER:RETRace.....	881
[[:SOURce<hw>]:SWEep:POWER:RUNNing?.....	881
[[:SOURce<hw>]:SWEep:POWER:SHAPE.....	880
[[:SOURce<hw>]:SWEep:POWER:SPACing:MODE?.....	878
[[:SOURce<hw>]:SWEep:POWER:STEP[:LOGarithmic].....	878
[[:SOURce<hw>]:SWEep:RESEt[:ALL].....	882
[[:SOURce<hw>]:SWEep[:FREQUency]:DWELI.....	878
[[:SOURce<hw>]:SWEep[:FREQUency]:EXECute.....	880
[[:SOURce<hw>]:SWEep[:FREQUency]:MODE.....	878
[[:SOURce<hw>]:SWEep[:FREQUency]:POINts.....	879
[[:SOURce<hw>]:SWEep[:FREQUency]:RETRace.....	881
[[:SOURce<hw>]:SWEep[:FREQUency]:RUNNing?.....	881
[[:SOURce<hw>]:SWEep[:FREQUency]:SHAPE.....	880
[[:SOURce<hw>]:SWEep[:FREQUency]:SPACing.....	879
[[:SOURce<hw>]:SWEep[:FREQUency]:STEP:LOGarithmic.....	881
[[:SOURce<hw>]:SWEep[:FREQUency]:STEP[:LINear].....	881
{[TRACE] LIST [#]: Pos0:State0; Pos1:State1; ...PosN-1:StateN-1}.....	757
{CLOCK: frequency}.....	752
{COMMENT: string}.....	752
{CONTROL LENGTH: ControlLength}.....	755
{CONTROL LIST WIDTH4-Length: #m0m1...mx...mM-1}.....	761
{COPYRIGHT: string}.....	753
{DATA BITLENGTH: BitLength}.....	753
{DATA LIST-Length: #d0d1...dx...dN-1...}.....	753
{DATE: yyyy-mm-dd;hh:mm:ss}.....	754
{EMPTYTAG-Length: #EmptySequence}.....	754
{LEVEL OFFS: RMSOffset_dB,PeakOffset_dB}.....	756

{MWV_SEGMENT_CLOCK_MODE: Mode}.....	760
{MWV_SEGMENT_CLOCK: ClockSeg0, ClockSeg1, ..., ClockSegN-1}.....	760
{MWV_SEGMENT_COUNT: NumOfSeg}.....	759
{MWV_SEGMENT_FILES: "FileNameSeg0.wv", "FileNameSeg1.wv", ..., "FileNameSegN-1.wv"}.....	761
{MWV_SEGMENT_LENGTH: SamplesSeg0, SamplesSeg1, ..., SamplesSegN-1}.....	759
{MWV_SEGMENT_LEVEL_OFFS:	
RMSOffs_dBSg0,PeakOffs_dBSg0, ..., RMSOffs_dBSgN-1, PeakOffs_dBSgN-1}.....	760
{MWV_SEGMENT_START:	
SampleStartOffsetSeg0, SampleStartOffsetSeg1, ..., SampleStartOffsetSegN-1}.....	759
{MWV_SEGMENTx_COMMENT: text}.....	761
{SAMPLES: Samples}.....	757
{TYPE: magic, xxxxxxxx}.....	751
{WAVEFORM-Length: #I0Q0I1Q1...IxQx...IN-1QN-1...}.....	758
*CLS.....	581
*ESE.....	581
*ESR?.....	581
*IDN?.....	582
*IST?.....	582
*OPC.....	582
*OPT?.....	582
*PRE.....	583
*PSC.....	583
*RCL.....	583
*RST.....	583
*SAV.....	584
*SRE.....	584
*STB?.....	584
*TRG.....	584
*TST?.....	585
*WAI.....	585

Index

Symbols

*OPC	956
*OPC?	956
*RST	967
*WAI	956
/var/user directory	587
/var/volatile directory	587
>L	558
&LLO	558
&NREN	558
1xEV-DO	88
3GPP FDD	88
9.91E37	
Remote control	955
50 - Extern reference out of range or disconnected	939
140 - This modulation forces other modulations off	939
180 - Adjustment failed	939
182 - Adjustment data missing	940
183 - Adjustment data invalid	940
200 - Cannot access hardware	940
201 - Hardware revision out of date	940
202 - Cannot access the EEPROM	940
203 - Invalid EEPROM data	940
204 - river initialization failed	940
241 - No current list	940
242 - Unknown list type specified	940
261 - Waveform Protected	940
460 - Cannot open file	940
461 - Cannot write file	940
462 - Cannot read file	940
463 - Filename missing	940
464 - Invalid filename extension	941
465 - File contains invalid data	941
A	
About	
Attenuator	346
Internal adjustments	921
Local oscillator	279
Power-On/EMF	484
Reference oscillator	272
Selftests	921
UCOR	352, 353
AC supply	32
Accept	
MCCW	220
Security settings	515
Accept carrier table	220
Access configuration menu	
Graphics	389
Accidental trigger	
Avoiding	101
Accurate level measurement	
Measurement period	410
Active connections	
Remote access	538
Active elements	78
Add, change, delete	
User key action	500
Additive noise	234
Adjust	
BB input signal	432, 434
Display and keyboard	481
Display settings	480
I/Q modulator	253
Keyboard settings	480
Adjustment frequency	
Reference oscillator	279
Adjustments	
All	927
Information	928
Last full adjustment	928
Settings	927
Advanced configuration	
LXI	544
ALC	
About	349
Detector sensitivity	351
Sample level	352
Settings	350
State	350
All packages	
Secure update policy	508
Alphanumeric parameters	81
AM	319
Overview	344
Ratio	329
Subsystem	660
Amplitude modulation	328
Depth	328
Ratio	329
Sensitivity	328
Subsystem	660
Analog modulation	
Options	319
Overview	343
Signal source	319
Analog wideband I/Q input	253
Angle alpha	
AQPSK	123
Annotation	
Disable amplitude display	511
Disable frequency display	511
Disable level	511
Aperture time	
Power sensors	373
Appearance	
Settings	483
Setup	480
Append	
Blank segment	178
Sequencing play list	185
Waveform	177, 178
Application	
External digital signal	408
Application cards	27
Application notes	27
Apply	
Assistant settings	211
External analog signal	408
External digital signal	408
Settings of external RF and I/Q instrument	423

- Apply and connect
 - Settings of external RF and I/Q instrument 423
 - APSK
 - Code rate 124
 - Gamma 124
 - ARB 71
 - Play list 167
 - Sequencer mode 167
 - Subsystem 707
 - Test generator selftest file 932
 - ARB multi-carrier
 - Conflict 209
 - Mode 202
 - ARB sequencer mode 168, 181
 - ARbitrary waveform generator 145
 - Arm trigger
 - DM 111
 - Armed_Auto
 - Common settings 110
 - Armed_Retrigger
 - Common settings 110
 - Arrow keys 46
 - ASK depth 123
 - ATN 975
 - Attention 975
 - Attenuation 128
 - Attenuator
 - About 346
 - RF signal 346
 - Settings 347
 - Attenuator settings
 - Level range 348
 - Mode 347
 - RF OFF mode 348
 - Auto
 - Common settings 110
 - Auto level set 433, 435
 - Auto once
 - Power sensors 372
 - Power viewer 372
 - Auto-negotiation
 - see Autonegotiation 38
 - Automatic level control
 - Detector sensitivity 351
 - Readjust internal switch position 270
 - RF signal 349
 - Sample level 352
 - Settings 350
 - State 350
 - Automation 520
 - Autonegotiation
 - Failed 943
 - Failure 38
 - Avahi
 - LAN services 514
 - Average level
 - Power viewer 370
 - Avoiding signal gaps 172
 - Avoiding wrap-around 172
 - AWGN
 - Additive white gaussian noise 229
 - Subsystem 787
 - AWGN mode 234
- B**
- B x T
 - DM 125
 - Bandwidth
 - Cosine filter 126
 - Modulation input 340
 - Noise generator 341
 - Baseband
 - Channel 432
 - Input 72
 - Selftest 930
 - Baseband connection selftest 929
 - Baseband gain (I/Q)
 - I/Q modulation 255
 - Baseband generator 71
 - Baseband Input
 - see BB Input 426
 - Baseband only
 - Mandatory setting 128
 - Baseband selftest 930
 - Baseband signal
 - Shifting quickly in RF domain 227
 - Basic workflow
 - Multi-segment waveform 189
 - Basics
 - Editor 316, 358
 - Export list files 361
 - Fill with sensor list files 360
 - Import list files 361
 - Baud rate
 - RS232 interface 536
 - BB Input 72
 - BBIN 426
 - Bias
 - I/Q OUT 440
 - Binary data
 - Edit, rules 770
 - Bit energy to noise power density 238
 - Bit rate 237
 - Block data 952
 - Block diagram
 - Display 76
 - Bluetooth 87
 - Boolean parameters 951
 - Brackets 952
 - Brochures 26
 - Browser settings
 - LXI 542
 - Burst gate 92
 - Bytes order
 - Definition 610
- C**
- C-List
 - See control list 130, 134, 767
 - CALibration subsystem 599
 - Carrier
 - Delay 208
 - Frequency 208
 - Gain 208
 - Index 208
 - State 208
 - State start/stop 210
 - Carrier + Interferer
 - PEP 240

- Carrier + Noise
 - PEP 240
- Carrier graph 211, 221
- Carrier leakage 244
 - Impairments 247
- Carrier power 238
- Carrier range 219
- Carrier spacing 202, 217
- Carrier table 220
- Carrier table assistant
 - Carrier range 219
 - First carrier 219
- Carrier/Noise ratio 237
- Cascading
 - LO 398
 - Reference frequency 398
- Case-sensitivity
 - SCPI 949
- CCDF diagram 382
- CCDF display 382
- CDMA2000 88
- Center frequency
 - Changing without adjusting the RF 227
- Central storage
 - Accessing 473
- Cfast card 51
- Change
 - GPIO address 548, 556
- Change password
 - Setup (security) 517
- Change user password
 - Setup (security) 517
- Channel
 - Name 431
- Check front panel
 - Key panel test 925
 - Performing 925
 - Settings 924
 - Touchscreen test 926
- Check touch panel
 - Touchscreen test 926
- Clean
 - List of external RF and I/Q instrument 422
- Cleaning 919
- Clear
 - RF output protection 348
- Clear history
 - Undo/Redo 518
- Clear status
 - Remote 581
- Clipping 203
- CList
 - See control list 134, 767
- Clock
 - Connectors 91
 - Frequency 153
 - Rate 153
- Clock rate
 - Blank segment 178
- Clock rate mode
 - Multi-segment waveform 180
- Clock signal
 - Internal 91
- Clock source 115
 - Internal 91
- Close
 - Show SCPI command 561
- Coding
 - DM 119
- Colon 952
- Comma 952
- Command sequence
 - recommendation 967
 - Remote 585
- Commands 946
 - Brackets 952
 - Colon 952
 - Comma 952
 - Command line structure 954
 - Common 946
 - Double dagger 952
 - Instrument control 946
 - Overlapping 955
 - Question mark 952
 - Quotation mark 952
 - SCPI confirmed 946
 - Sequential 955
 - Syntax elements 952
 - Vertical stroke 952
 - White space 952
- Commands of all settings
 - SCPI list 455
- Comment 175
- Common commands
 - Syntax 948
- Complementary cumulative distribution function 382
- Computer name
 - Changing 38
 - Syntax 38
 - Use instead of IP address 38, 40
- CONDition 961
- Configuration
 - Restoring 456
 - Restoring instrument settings 451
- Configuration list
 - Multi-segment waveform 169
- Configure
 - Control signal 132
- Configuring
 - GUI appearance 483
- Configuring LAN services 513
- Confirm unsigned
 - Secure update policy 508
- Confirm user password
 - Setup (security) 516, 517
- Conflict 209
- Connect
 - External RF and I/Q instrument 423
- Connect all remote 417
- Connect remote instruments
 - Keep connection on preset 417
 - On start up 416
- Connected device 430
- Connection fault
 - 169.254.*.* 943
- Connector
 - AC power supply 51
 - Control signal 49
 - Data 49
 - DIFF I/Q 49
 - Differential output 49
 - Digital IQ 49
 - Direction 492
 - Find 425

- Global 487, 492
- GPIB 50
- High-speed digital IQ 49
- I 49, 50
- I Bar 49
- Identify 425
- IEC/IEEE 50
- Inst Trig 50
- LAN 51
- LF 50
- LO In 49
- LO Out 49
- Mapping 486
- Mod Ext 50
- Pulse Ext 50
- Pulse Video 50
- Q 49, 50
- Q Bar 49
- Ref In 50
- Ref Out 50
- RF 47
- Sensor 46
- Shared 487
- Show 425
- Signal 493
- Signal Valid 50
- Single-ended output 49
- USB 46, 51
- USB In 51
- User 47, 487, 492
- USER 48
- Connector direction
 - Settings 417
- Connector local, global
 - Signal, how to define 495
- Connectors 47
- Const I/Q test signal 146
- Constant I/Q test signal
 - Settings 157
- Constellation diagram 380
- Context-sensitive menu 78
- Control bus 975
- Control list
 - ASCII format 134, 768
 - Binary format 768
 - Edit, rules 770
 - How to assign 135, 769
 - Manually (Control data editor) 134
 - Select 121
 - Select, edit, new 460
 - Tags 768
- Control signal 92
- Copy
 - Instrument settings 464
 - Several files 462, 470, 471
 - Show SCPI command 561
- Counter 935
- Couple I/Q bias 440
- Coupling mode
 - AM, FM, PhiM 339
 - External modulation input 339
- Create 176, 206
 - Multi-carrier waveforms 197
 - New directory 464
- Create and load 176, 206
- Crest factor
 - BB Input 435
 - Channel 432
 - Desired value 218
 - External analog signal 255
 - Match 409
 - Optimize (MCCW) 217
 - Where to find the value 410
- Crest factor mode 203
- Current frequency
 - Adjust 253
 - Sweep 302
- Current index
 - List mode 309
- Current level
 - Sweep 302
- Current segment 186
- Custom Digital Modulation 71
- Cut
 - Instrument settings 464
- Cut off frequency factor 125
- CW
 - Frequency 264
- CW (continuous wave) 92
- CW frequency 235, 240
- CW interferer 234
- CW mode
 - Output level 267
- CW signal
 - Generate in baseband 118
 - Settings 262
- CW/Mod 92
- D**
- D-List
 - See data list 769
- Data entry 80
- Data format
 - Definition 611
- Data list 120
 - Access 457
 - Binary format 770
 - Edit, rules 770
 - Editor 128
 - How to access 588
 - How to assign 137, 770
 - How to create 136, 461
 - Manually (data list editor) 136
 - Select 121
 - Select, edit, new 460
 - Standard modulation data source 90
 - Tags 769
- Data sheets 26
- Data source
 - Data list 90
 - DM 120
 - Extern serial data 120
 - Pattern 90
 - PRBS generator 90
- Data valid 975
- Datasheet
 - LXI 546
- Date 923
- DAV 975

- DC carrier leakage
 - Eliminating 227
 - How to shift baseband signal 227
- Deactivate RF output 276
- Deactivated licenses 503
- DEF 951
- Default directory
 - Mass memory 587
 - User data 444, 587
- Default instrument settings 34
- Default settings 201
 - ARB 152
 - DM 118
 - I/Q output analog 438
 - MCCW 217
- Default values
 - Remote 583
- Define
 - User key action 500
- Delay
 - Double pulse (PULM) 333
 - Falling edge of ramp envelope 128
 - Marker 114
 - PULM 333
 - Rising edge of ramp envelope 128
 - Trigger 113
- Delay start 211
- Delay step 211
- Delete
 - Instrument settings 464
 - List mode file 311
 - Sequencing list 185
 - Waveform 177, 178
- Delete instrument settings 597
- Delete temporary files 933
- Delta frequency
 - External RF and I/Q instrument 419
- Delta phase
 - RF frequency 271
- Destination
 - Connection selftest (BNC) 929
- Detect
 - External RF and I/Q instrument 421
- Detector sensitivity
 - Automatic level control 351
- Deviation
 - FSK modulation 123
 - PhiM 326
 - Variable FSK 124
- Deviation mode
 - FM 325, 327, 328
 - Frequency modulation 325, 327, 328
- Device ID 503
- Device reset 586
- Device-specific commands 946
- Device-specific error messages 939
- DHCP 39
- Dialog
 - Snapshots 483
- Dialog boxes 79
- DIFF I/Q
 - see I/Q BAR 409
- Differential coding
 - DM 119
- DIG IQ auto setting 432, 434
- Digital attenuation 440
 - RF level 268
- Digital Attenuation
 - Sweep 308
- Digital I/Q
 - Input 426
- Digital inputs
 - Connector type 429
- Digital modulation
 - See DM 116
- Digital standard 71
 - Supported 87
- Direction
 - Connector 417
- Directory
 - Temporary data 587
 - User data 587
- Disable
 - Frequency display 511
 - Level display 511
- Disconnect all remote 417
- Display
 - Active elements 78
 - Block diagram 76
 - Brightness 482
 - Context-sensitive menu 78
 - Info line 78
 - Information 75
 - Keyboard layout 483
 - Lock 511
 - Mapped connectors 416
 - On-screen keypad 78
 - Power sensors 370
 - SCPI list 562
 - Screen saver 482
 - Settings 481
 - Setup 481
 - Status bar 75
 - Tab labels 78
 - Taskbar 77
 - Wait time (screen saver) 482
- Display correction value
 - UCOR 356
- DISPlay subsystem 605
- Display unit 390
- Distortion-free range
 - Max bandwidth 148
 - Resampling 148
- Distribution
 - Noise generator 340
- DList
 - See data list 769
- DNS server 534
- DNS suffix 534
- Documentation overview 25
- Double dagger 952
- Double pulse delay
 - PULM 333
- Double pulse width
 - PULM 333
- DOWN 951
- Downgrade information 936
 - Factory version 936
 - Min. version 936
- Duration
 - Measurement period external digital signal 410
- Dwell time
 - Sweep 304

- Dwell time mode
List mode 310
- E**
- EDGE Evolution 87
Edge form of ramp envelope 127
Edge slope of ramp envelope 127
Edit
Binary data 770
Data list 128
Editor 316, 359
List mode data 311
Ramp in control list 132
UCOR data 356
Editor
Basics 316, 358
Edit 316, 359
Fill with sensor 316, 359
Goto 316, 358
Save 316, 359
Save as 316, 359
EDR 87
Electrostatic discharge 28
EMF display
RF level 484
EMI suppression 29
Emulating front panel keys 84
Emulation
IDN string 538
Language 537
Mode 537
Set IDN and OPT to default 538
Enable
LAN interface 514
ENABLE 961
Enable registers
Remote 583
Enhanced features TD-SCDMA 88
Enter license key 503
Enter password
Setup (security) 514
Envelope tracking power amplifiers tests 439
EOI 975
Error log 944
Error message
Missing burst gate marker in waveform File, please disable RF power ramping 151
No or empty waveform file 151
Error messages 941
Adjustment data invalid (183) 940
Adjustment data missing (182) 940
Adjustment failed (180) 939
Cannot access hardware (200) 940
Cannot access the EEPROM (202) 940
Cannot open file (460) 940
Cannot read file (462) 940
Cannot write file (461) 940
Driver initialization failed (204) 940
Extern reference out of range or disconnected (50) . 939
File contains invalid data (465) 941
Filename missing (463) 940
Hardware revision out of date (201) 940
Invalid EEPROM data (203) 940
Invalid filename extension (464) 941
No current list (241) 940
This modulation forces other modulations off (140) .. 939
Unknown list type specified (242) 940
Waveform Protected (261) 940
Error Messages 938
device-specific 939
SCPI 939
Error queue 962
Error queue query 885, 886, 887
Error queues
recommendations 967
ESD 28
ESE (event status enable register) 963
ESR 960
ESR (event status register) 963
EUTRA/LTE 88
EVENT 961
Event status enable register (ESE) 963
Remote 581
Event status register (ESR) 963
Remote 581
Exclude frequency 455
Exclude level 455
Execute
Baseband selftest 930
Next segment 188
Single sweep 305
Trigger (list mode) 311
Expiration date of option 937
Export
Execute 313, 363
SCPI 461
SCPI export 563
SCPI list 562
SCPI settings 563
Export deactivation response 503
Export license key 503
Export list files
Basics 361
Express level in
Volts 859
External analog signal
Apply 408
Feed to the instrument 408
External digital signal
Application fields 408
Apply 408, 426
Baseband input 426
Feed to the instrument 408
Interface type 429
Possible applications 408
Required if 408
External frequency
Reference oscillator 276
External instrument
Settings 418, 420
External RF and I/Q
Alias name 422
Settings 414
External RF and I/Q instruments
Control 406
External trigger
Common source 405
Configuring 405
Providing the instrument with 405
External Trigger Delay
DM 113
Eye diagram 381

- F**
- Factory
 - Preset 448
 - Factory preset
 - Change GPIB address 548
 - GPIB address 556
 - Factory version
 - Firmware 936
 - Failure
 - Network connection 38
 - Fall delay 128
 - Feedback
 - Connector 493
 - Signal 493
 - Feeding
 - External analog signal 408
 - External digital signal 408, 426
 - File
 - Multi-carrier table 208
 - SCPI export 563
 - Waveform 152
 - File catalog
 - List mode 311
 - File contents
 - Multi-segment waveform 176
 - File handling 444
 - File list 592
 - File manager 462
 - File name 475
 - File select
 - Dialog 457
 - File server
 - Data exchange 473
 - File sharing 468
 - File storage location 587
 - File system 442
 - Accessing 468
 - File transfer 444
 - From file server 473
 - FTP/SAMBA 520
 - How to 468
 - File type selection 463
 - Files
 - User data 442
 - Fill
 - User correction data 316, 359
 - Fill table
 - Automatically 316, 359
 - UCOR 356
 - Fill with sensor
 - Basics 360
 - Editor 316, 359
 - Filter
 - DM 125
 - Power sensors 371
 - Filter cut off frequency 203
 - Filter length
 - Auto 372
 - User-defiend 372
 - Filter parameter
 - B x T 125
 - Cut off frequency factor 125
 - Impact 106
 - Roll off factor 125
 - Finding out the default directory 444, 587
 - Firmware
 - Factory version 936
 - Min. version 936
 - Version 936
 - Firmware options
 - see Software options 71
 - Fixed
 - Frequency 264
 - Fixed mode
 - I/Q Out 439
 - Flexible dynamic switch over 190, 191
 - Without signal interruptions 191
 - Floating licenses 937
 - FM 319
 - Deviation 325
 - Deviation mode 325, 327, 328
 - Ratio 326
 - Subsystem 665
 - Total depth 326, 327, 329
 - Format
 - SCPI Export 563
 - FORMat subsystem 610
 - FPGA/ μ C
 - Check for updates 932
 - Shut down after update internal 933
 - Update installation internal assembly 933
 - Update table 932
 - Free space
 - internal memory 933
 - Frequency
 - Annotation disable 511
 - CW, fixed 264
 - LF generator 338
 - LF sweep 338
 - Multiplier 265
 - Offset 265
 - Power sensors 371
 - RF signal 263
 - Test generator selftest 931
 - Test signal ARB 155
 - UCOR 356
 - Frequency modulation 325
 - Deviation mode 325, 327, 328
 - Ratio 326
 - Subsystem 665
 - Total depth 326, 327, 329
 - Frequency offset
 - Between the I/Q streams 414
 - External signal 227
 - Internal signal 227
 - Frequency, internal
 - AM 338
 - FM 338
 - Front panel
 - Checking 924
 - Front panel test
 - Performing 925
 - FSK deviation 123
 - FSK type
 - Variable FSK 123
 - ftp
 - How to access the instrument 468
 - FTP
 - LAN services 514
 - Function check 34
 - Function keys
 - Overview 44

G

Gain	
Impairment	243
Test generator selftest	931
Gain Imbalance	243
Gain start	210
Gain step	210
Gateway	534
General configuration of instrument	480
General instrument settings	480
General workflow	
Multi-segment waveform	189
Generate test signal	
HD	155, 157, 158
RAM	155, 157, 158
Generating	
Time aligned signals	401
Generating an unmodulated signal	262
Generating short sequences	101
Getting started	25
Global dwell time	
List mode	310
Goto	
Editor	316, 358
GPIO	
Bus address	536
Change address	548, 556
Characteristics	527
Set up remote control	556
GPIO address	536
Factory preset	556
Graphical signal monitoring	378
Graphics	
Number of samples	387
GSM/EDGE	87
GUI	
Setting	485
GUI update	
Setup	480

H

Hard copy	
Create, how to	478
File format	476
Print, how to	478
Hard disk	
Deleting temp files	933
Hardcopy	474
Options	476
Hardware channel	
External RF and I/Q	422
Head panel	
see Status bar	42
Header	
see Status bar	42
Help	25, 82
High-speed switch over	
How to	192
HiSLIP	
Protocol	525
Resource string	523
History	
Undo/Redo	518
Host name	
see computer name	38, 40

Hostname	533
External RF and I/Q	423
LXI	541
see computer name	38, 40
Hotspot	76
How to	
Change the default directory	588
Use an absolute file path	588
HSPA	88
HSPA+	88
HTTP	
LAN services	514

I

I Offset	244
I/Q	
External RF and I/Q settings	417
I/Q connection	
Status	418
I/Q diagram	379
I/Q Impairments	
Linear	243
I/Q mod	
Input signal	253
I/Q modulation	251, 252
Gain	255
Performance optimization	255, 257
I/Q output	
RF envelope	439
I/Q output analog	
Settings	435
I/Q output type	
Differential	439
Envelope, E	439
Inverted envelope, E BAR	439
Single ended	439
I/Q stream mapper	
Settings	414
I/Q swap	253
I/Q wideband	254
Identification	
Emulation mode	537
Remote	582
Identify	
Connector	425
Identify connector	
Setting	425
IDN string	
Emulation mode	538
IEEE 802.11 p/j	88
IEEE 802.11a/b/g/n	88
IEEE 802.11ac	88
IEEE 802.11ax	88
IFC	975
Image rejection	
Test signal	222
Imbalance	
Impairments	247
Impairment	
Analog	243
Digital	243
Linear	243
Impairments	
Analog	245
Digital	245

- Impedance
 - External modulation source 340
 - Import
 - Execute 313, 363
 - Import license key 503
 - Import list files
 - Basics 361
 - Import/Export
 - Lists 312
 - Select file 313, 362, 363
 - Inactive licenses 503
 - Index
 - List mode 309
 - INF 951
 - Info line 78
 - Information
 - Internal adjustments 928
 - Inhibit trigger 101
 - Input
 - Clock slope 495
 - Impedance Clock/Trigger 495
 - Impedance external modulations 340
 - Pulse polarity 335
 - Pulse threshold 495
 - Threshold Clock/Trigger 494
 - Trigger impedance 335
 - Trigger slope 495
 - Input connector 47, 48, 49, 50
 - Input waveform file 211
 - Input/output signals and interfaces
 - Overview 407
 - Installed assembly 935
 - Instrument configuration
 - External 420
 - Instrument control 73
 - Instrument emulations 531, 537
 - Instrument help 25
 - Instrument messages 946
 - Instrument name
 - External RF and I/Q instrument 419
 - Instrument security procedures 26
 - Instrument settings
 - Recall 583, 597
 - Save 584, 598
 - Interface
 - functions (GPIB bus) 976
 - Interface clear 975
 - Interface messages 946, 947
 - Interfaces
 - GPIB 527
 - USB 526
 - Interferer
 - CW, generation 229
 - Interfering signal
 - Use an external digital signal 408
 - Internal
 - Clock reference 91
 - Internal adjustments
 - About 921
 - internal memory
 - Deleting temp files 933
 - Interrupt 965
 - Invalid results
 - Remote control 955
 - IoT
 - eMTC 88
 - NB-IoT 88
 - IP address 523
 - Changing 39
 - Dynamic 534
 - External RF and I/Q 423
 - LXI 541
 - Not recognized 943
 - Zeroconf 534
 - IP address Mode 533
 - IP configuration
 - LXI 543
 - IQ delay
 - Impairments, digital 248
 - IQ skew
 - Impairments, digital 248
 - IQ subsystem 822
 - IST 960
 - IST flag
 - Remote 582
- J**
- Joint carrier configuration 219
- K**
- Key 44, 46
 - ★ (User) 44, 452
 - Access on a remote computer 84
 - Backspace 44
 - Down 46
 - Emulation 84
 - Enter 44
 - Esc 44
 - Freq 44
 - Help 43
 - Home 44
 - Left 46
 - Level 44
 - Local 43
 - Mod on/off 44, 321
 - Next window 46
 - On/Off Toggle 44, 46
 - On/Standby 43
 - Preset 43
 - Resize window 46
 - RF on/off 44
 - Right 46
 - Save/Rcl 43, 452
 - Setup 43
 - Up 46
 - Key panel test
 - Check front panel 925
 - Keyboard
 - On-screen 80
 - Setting 485
 - Settings 481
 - Setup 481
 - Subsystem 616
 - Usage 74
 - Keypad
 - On-screen 80
 - Overview 44
 - Keywords
 - see Mnemonics 947

- L**
- LAN
 - Interface 523
 - IP address 523
 - Reset 541
 - Services 513
 - VXI protocol 525
 - LAN configuration 37
 - LXI 543
 - LAN connection
 - Not working 38
 - LAN interface
 - Avahi 514
 - Enable 514
 - FTP 514
 - HTTP 514
 - LAN over SCPI 514
 - SMB (Samba) 514
 - SSH 514
 - VNC 514
 - LAN status
 - LXI 541
 - Language
 - Emulation 537
 - Last factory calibration 935
 - Last full adjustment
 - Internal adjustments 928
 - Layout
 - Keyboard 483
 - Length
 - Control list 132
 - Lev Att
 - see Level attenuation 92
 - LEV_ATT 128
 - Level
 - Annotation disable 511
 - BB Input 435
 - Behavior (RF) 268
 - I/Q output signal 440
 - Noise generator 343
 - Level attenuation 92
 - DM 128
 - Level default unit
 - Change 859
 - Level in SCPI in V 859
 - Level limit 267
 - Level mode
 - Multi-segment waveform 179
 - Level offset
 - Power sensors 371
 - RF level 268
 - State (power sensors) 371
 - Level range
 - Attenuator settings 348
 - Level settings
 - On start-up 484
 - LF frequency sweep
 - State 301, 336
 - LF generator
 - Shape 337
 - LF Out
 - Overview 344
 - LF output 341
 - Offset 342
 - Period 338
 - Pulse duty cycle 338
 - Pulse width 338
 - Shape 337
 - Source 342, 344
 - Source impedance 342
 - Sweep reset 305
 - Trapezoid high 339
 - Trapezoid rise, fall 339
 - Triangle rise 338
 - Voltage 342
 - LF sweep
 - Frequency 338
 - License for software option 937
 - Infos 936
 - Limit
 - RF level 267
 - Linux 35
 - List
 - Define 311
 - Range 312
 - State 309
 - Values, defining 315, 358
 - List file
 - Catalog 311
 - List mode
 - Create list automatically 316, 359
 - Current index 309
 - Dwell time mode 310
 - Edit 311
 - Execute trigger 311
 - Export user data 313, 363
 - File settings, import/export 313, 362
 - Global dwell time 310
 - Import/export 312, 362
 - Load from file 313, 362
 - Load user data 312
 - Reset 310
 - Select file 311
 - Settings 308
 - State 309
 - Trigger execute 311
 - Trigger source 309
 - LO OUT Frequency
 - Display 282
 - Load
 - See recall 452
 - User filter 126
 - Waveform 152
 - Load instrument settings 583, 597
 - Load list 175
 - Load user mapping 123
 - Loading
 - Trying out 65
 - Local oscillator
 - About 279
 - Mandatory LO in frequency 282
 - Options 280
 - Out state 281
 - Settings 281
 - Local to remote switch over 558
 - Lock
 - Display 511
 - Low energy 87
 - LSB/MSB order
 - Definition 610
 - LTE advanced 88
 - LTE Rel. 8/Rel. 9/Rel. 10/Rel. 11/Rel. 12/Rel. 13/Rel. 14 . 88
 - LTE-A 88

LXI			
Advanced configuration	544		
Browser settings	542		
Configuration	575		
Datasheet	546		
Hostname	541		
IP address	541		
IP configuration	543		
LAN configuration	543		
LAN status	541		
MAC address	541		
Ping	545		
Remote trace (SCPI)	545		
Reset (LCI)	541		
Status settings	541		
LXI settings	540		
M			
Mac address	535		
MAC address			
LXI	541		
Maintenance	921		
Malfunctions			
reacting	967		
Mandatory LO in frequency			
Local oscillator	282		
Manual interaction	74		
Map network share			
Settings	463, 464		
Map stream X to connector			
Settings	414		
Mapping network drives/folders			
How to	466		
Marker	94		
Marker Delay	114		
Marker output signals	94		
Marker positions	133		
Marker trace			
Periodical	755		
Mass storage			
Removable	51		
Mass storage location	587		
Master-slave			
Assign signal	401		
Mode	401		
State	400		
Sync signal state	401		
Matching			
Crest factor	409		
MAX	951		
Maximal deviation			
Frequency modulation	325		
PhiM	326		
Maximum overall output voltage	412, 437		
Measurement period	433, 435		
How long	410		
Messages			
Commands	946		
Instrument	946		
Instrument responses	947		
Interface	946		
MIN	951		
Min. version			
Firmware	936		
Minimum locking range	277		
Mnemonics	947		
Optional	949		
Mode			
Attenuator settings	347		
Emulation	537		
Frequency modulation	326		
Graphics	387		
I/Q Out	439		
IP address	533		
List	309		
Local oscillator	281		
PhiM	327		
PULM	330		
Pulse modulation	330		
RF level	269		
Sweep	302		
User variation	265, 270		
Modulation			
AM	322		
Analog	319		
Bandwidth, external input	340		
External coupling	339		
FM	322		
Input impedance	340		
Overview	343		
Phase	322		
PhiM	322		
PM	322		
Pulse	322		
Source	325		
State	325		
Modulation data			
Source internal	90		
Modulation depth			
AM	328		
Modulation sensitivity			
AM	328		
Modulation type	122		
Modulations state			
Toggle	321		
Monitoring			
Signal parameter	378		
More free disc space			
Deleting temp files	933		
Mount network drive			
How to	466		
Mounting			
Rack	32		
Mouse			
Usage	74		
Multi carrier signal			
General principle	198		
Multi-carrier CW	215		
Subsystem	771		
Multi-carrier waveforms	197		
Multi-instrument setup			
Simultaneous signal generation start	401		
Synchronous signals	401		
Time aligned signals	401		
Multi-segment			
Crest factor	188		
Multi-segment table	177		
Multi-segment waveform			
File contents	176		
Multi-segment waveform sequencing	168		
Multiple files			
Copy	462, 470, 471		

- Multiplier
 - Frequency 265
- N**
- Naming conventions
 - Allowed file names 442
- NAN 951
- NAN (not a number)
 - Remote control 955
- Navigation keys 45
- NDAC 975
- Network
 - Connection fails 943
 - Settings 532
- Network connection
 - Error 38
- Network share
 - Mapping 464
 - Mapping, how to 466
- Network status 532
- New list 175
- New password
 - Setup (security) 517
- New user password
 - Setup (security) 516
- Next segment 187
 - Mode 187
 - Source 188
- NINF 951
- Noise
 - Additive, generation 229
 - Distribution 340
 - Pure, generation 229
- Noise bandwidth
 - AWGN 240
- Noise bandwidth limitation
 - System bandwidth 341
- Noise generator
 - Bandwidth 341
- Noise level
 - Absolute system bandwidth 343
 - Relative system bandwidth 343
- Noise only 234
- Noise power
 - System bandwidth 239
 - Total bandwidth 240
- Noise ratio
 - Power sensors 372
- Non-dedicated connectors 486
- NR Rel. 15 89
- NRFD 975
- NRP power viewer
 - Settings 368
 - Use S-Parameter 373
- NRP sensor mapping
 - Connector 366
 - Protocol 366
 - Scan 366
 - Sensor name 366
 - Settings 366
- NTP
 - Address 923
- NTRansition 961
- Number of carriers 202, 217
- Number of licenses 937
- Numeric data entry 80
- Numeric parameters 81, 950
- Numeric values
 - Special 951
- O**
- OFDM 89
- Offset
 - Envelope, E 441
 - Frequency 265
 - I/Q OUT 441
 - Inverted envelope, E BAR 441
- Offset I/Q
 - Impairments 247
- Old password
 - Setup (security) 517
- Old user password
 - Setup 516
- On-screen keyboard 81
- On-screen keypad 78
- ON/OFF ratio marker 96
- Open source acknowledgment (OSA) 26
- Open source acknowledgments 936
- Operating system 35
- Operation
 - Manual 74
- Operation complete
 - Remote 582
- Operation hours 935
- Operation mode 452
- Optimization mode 255, 257
 - RF 255, 257
- Optimize crest factor
 - Multi-carrier 203
- Optimize for current setting 257
- Option
 - Expiration date 936
 - R&S SMBVB-K16 49
- Option: expiration date 937
- Options
 - Analog modulation 319
 - Identification (remote) 582
 - Local oscillator 280
 - see User Manual 71
- Oscillator
 - Mandatory LO in frequency 282
 - Mode (local) 281
 - Reference 272
- Output
 - LF 342
 - SCPI list (select file) 563
 - Source (LF output) 344
 - State (LO coupling) 281
 - Video polarity (PULM) 323
 - Video polarity (pulse modulation) 323
- OUTPut
 - Subsystem 617
- Output connector 47, 48, 49, 50
- Output file 176, 206
 - Multi-segment waveform 169
- Output queue 960
- Output voltage, max
 - I/Q OUT 412, 437
- Output, LF
 - Offset 342
 - Voltage 342

- Overflow
 - Avoid 410
 - External signal 410
- Overlapping commands 955
 - Preventing 956
- Oversampling factor 148
- Overview
 - AM 344
 - External RF and I/Q 426
 - LF Out 344
- P**
- Packing 920
- Parallel poll register enable
 - Remote 583
- Parameters
 - Block data 952
 - Boolean 951
 - Entering 81
 - Numeric values 950
 - SCPI 950
 - Special numeric values 951
 - String 952
 - Text 952
- Parity
 - RS232 interface 536
- Password
 - Change (security password) 517
 - Change (user password (security)) 517
 - Confirm (security password) 517
 - Confirm (user password (security)) 516
 - Enter (security password) 514
 - New (security password) 517
 - New (user password (security)) 516
 - Old (security password) 517
 - Old user password 516
 - Protection level 507
- Password management
 - Security 515
- Paste
 - Instrument settings 464
- Pattern
 - Data source 120
 - Standard modulation data source 90
- PCI bus 935
- Peak power
 - BB Input 435
 - Channel 432
- PEP
 - Carrier + Noise 240
- Percentage of signal bandwidth
 - Graphics 388
- Performance
 - I/Q modulation 255, 257
- Period
 - Blank segment 178
- Periodical
 - Marker trace 755
- Periodical markers 762
- Phase
 - First carrier 220
 - Subsystem 858
- Phase fluctuations between RF signals
 - How to minimize 398
- Phase modulation 326
 - Deviation 326
 - Mode 327
 - Ratio 327
 - Subsystem 670
- Phase offset 227
 - Between the I/Q streams 414
- Phase reference 271
- Phase start 210
- Phase step 210, 220
- Phase-aligned RF signals
 - How to 398
- Phase-coherent RF signals
 - How to 398
- PhiM
 - Mode 327
 - Ratio 327
 - see Phase modulation 326
- Ping
 - LXI 545
- Play list 169, 175, 183, 188
- Play list file
 - Sequencing list file 169
- Playlist
 - See play list 169
- PM 319
 - Subsystem 670
- PN sequence
 - See PRBS 90
- Polarity
 - Pulse generator output 333
 - Pulse modulation 335
- Position
 - Cursor in graphical display 133
- Power
 - Carrier + Interferer 240
 - Carrier + Noise 240
 - First carrier 219
 - Signal + Interferer 240
 - Signal + Noise 240
 - UCOR 356
- Power amplifiers testing
 - Envelope 439
- Power of starting carrier 210
- Power on
 - Key 43
- Power ramp
 - Restrict to baseband 128
- Power ramping 92, 127
- Power reference 204
- Power sensors
 - Activation 370
 - Aperture time 373
 - Auto once 372
 - Filter 371
 - Filter length 372
 - Frequency 371
 - Level (average) 370
 - Level (peak) 370
 - Level offset 371
 - Noise ratio 372
 - Serial number 370
 - Source 371
 - State 370
 - State (level offset) 371
 - Timeout 372
 - Unit 370

- Update 368
 - Use default aperture time 373
 - Zero 370
 - Power Sensors
 - Display 370
 - Power spectrum 383
 - Power step 220
 - Power supply
 - Connector 51
 - Power switch 32
 - Power viewer
 - Auto once 372
 - Power-On
 - Settings 484
 - Power-On count 935
 - Power-On state
 - RF level 484
 - Power-On/EMF
 - About 484
 - RF signal 484
 - PPE 960
 - PRBS generator
 - Standard modulation data source 90
 - PRBS type 120
 - Prefix, year, month, Day 477
 - Preset
 - Factory preset 448
 - Ramp 132
 - Preset instrument settings 34
 - Print
 - Hard copy 478
 - Processing time 101
 - Protection
 - Settings 506
 - Setup 505
 - Protection level
 - 1 505
 - 2 506
 - 3, 4, 5 506
 - Adjustments 505
 - Calibration 506
 - Factory only 506
 - Protection level 507
 - Service department 506
 - Protocol
 - VXI 525
 - PTRansition 961
 - PULM
 - Delay 333
 - Double pulse delay 333
 - Double pulse width 333
 - Impedance (trigger input) 335
 - Mode 330
 - Output video polarity 323
 - Period 332
 - Pulse polarity (input) 335
 - Source 323
 - State 323
 - Subsystem 674
 - Threshold (pulse input) 495
 - Transition type 323
 - Width 332
 - Pulse
 - Duty cycle 338
 - Length (PULM) 332
 - Period 338
 - Width 338
 - Width (PULM) 332
 - Pulse divider marker 95
 - Pulse frequency marker 95
 - Pulse generator
 - Delay 333
 - Output polarity 333
 - Output state 333
 - Single Trigger 333
 - Subsystem 857
 - Width 332
 - Pulse graph
 - Zoom In/Out 334
 - Zoom position 334
 - Zooming 334
 - Pulse modulation 322
 - Double pulse delay 333
 - Double pulse width 333
 - Mode 330
 - Output video polarity 323
 - Period 332
 - Pulse input threshold 495
 - Pulse polarity (input) 335
 - Repetition frequency 332
 - see PM 322
 - Source 323
 - State 323
 - Subsystem 674
 - Trigger input impedance 335
 - Trigger mode 330
 - Purge
 - List of external RF and I/Q instrument 422
- ## Q
- Q Offset 244
 - QR code 539
 - QSFP cable
 - Disconnect 49
 - Plugin 49
 - Quadrature offset
 - Impairments 248
 - Quadrature Offset 245
 - Queries 946, 954
 - Status 965
 - Question mark 952, 954
 - Questionable status register 964
 - Quick shift of the baseband signal
 - How to 227
 - Quotation mark 952
- ## R
- R&S signed packages
 - Secure update policy 508
 - Rack
 - Mounting 32
 - Raised cosine filter
 - see Cosine filter 142
 - Ramp
 - All up or all down 132
 - Low to high and vice versa 132
 - Ramp function 127
 - Ramp time 127
 - Ratio
 - AM 329
 - Amplitude modulation 329

- FM 326
- Frequency modulation 326
- Phase modulation 327
- PhiM 327
- Ratio noise/system bandwidth
 - Minimum 235
- Readjust
 - Automatic level control 270
- Ready state 33
- Recall
 - Instrument settings 455
- Recall instrument settings 583, 597
- Recall intermediate 455, 583
- Recommendations
 - remote control programming 967
- Recorded SCPI commands
 - SCPI list 562
- Rect test signal 146
- Rectangular test signals
 - Settings 155
- Redo 517
 - Clear history 518
 - History 518
 - Settings 518
 - State 518
- Reference curve
 - Show, hide, assign 390
- Reference frequency output
 - 1 GHz 278
 - Loop through 278
- Reference oscillator 272
 - Adjustment 279
 - Adjustment frequency 279
 - External frequency 276
 - Output frequency 278
 - Preset 276
 - Reference frequency, variable 277
 - RF off state 276
 - Source 276
 - Synchronization bandwidth 277
- Registers 960
- Release notes 26
- Reload
 - SCPI list 564
- Remote access 520
 - Active connections 538
 - DNS server 534
 - DNS suffix 534
 - GPIB address 536
 - GPIB resource (Visa resource string) 535
 - HISLIP resource (Visa resource string) 535
 - Identification 537
 - IDN string 538
 - Instrument emulations 537
 - IP address mode 533
 - Language 537
 - Network gateway 534
 - Network hostname 533
 - Network IP address 534
 - Network Mac address 535
 - Network resource (Ethernet resource string) 535
 - Network settings 532
 - Network status 532
 - OPT string 538
 - QR code 539
 - RS232 536
 - see Remote operation from a computer 73
- Serial 535
- Set IDN and OPT to default 538
- Settings 531
- Socket resource (Visa resource string) 535
- Subnet mask 534
- USB Visa resource string 535
- Visa resource strings 535
- Workgroup name 533
- Remote connection
 - Not working 38
 - Status 418
- Remote control 83
 - Basics 946
 - Command 425
 - Command sequence 425
 - GPIB 556
 - History 425
 - IQ analog 824
 - IQ digital 824
 - Mode 425
 - Programming examples 580
 - RF envelope 824
 - SCPI 520
 - Source subsystem 647
 - Trace 425
- Remote operation 84
 - VNC 520
- Remote trace
 - LXI 545
- Removable
 - Mass storage 51
 - Non-Volatile Memory 51
- Removing sensitive data 944
- REN 975
- Rename
 - File 597
 - Instrument settings 464
- Resampling
 - External baseband signal 410
- Reset
 - List mode 310
 - RF frequency (delta phase) 271
 - Sweep 305
- Reset device parameters 586
- Reset instrument settings 34
- Reset values
 - Remote 583
- Resolution
 - Graphics 388
- Resource string
 - VISA 523
- Restart marker 180, 181
- Restoring configuration 447
- Result
 - Connection selftest (BNC) 929
- Resulting file name 477
- Retrace
 - Sweep 303
- Retrigger
 - Common settings 110
- Rev. A / Rev. B 1xEV-DO 88
- RF
 - Signal 260
- RF couple
 - External RF and I/Q instrument 419
- RF envelope 439

- RF frequency
 - Configuring 262
 - External RF and I/Q instrument 419
 - RF frequency sweep
 - State 301
 - RF level
 - Configuring 262
 - Digital attenuation 268
 - EMF display 484
 - External RF and I/Q instrument 419
 - Mode 269
 - Offset 268
 - Power-On state 484
 - Setting characteristics 268
 - Settings 266
 - RF level sweep
 - State 301
 - RF OFF mode
 - Attenuator settings 348
 - RF off state
 - Reference oscillator 276
 - RF ON, RF OFF, RF ON/OFF 261
 - RF output
 - Amplitude 267
 - Impedance 261
 - Protection 348
 - State 261
 - RF Output
 - Level range 269
 - RF output signal
 - Phase 271
 - Phase reference 271
 - RF path
 - External RF and I/Q 423
 - RF phase
 - Configuring 262
 - RF signal
 - Analog modulation 319
 - Attenuator 346
 - Automatic level control 349
 - Frequency 263
 - Power-On/EMF 484
 - User correction 352
 - RF state
 - External RF and I/Q instrument 420
 - Rise delay 128
 - RMS power
 - BB Input 435
 - Channel 432
 - Roll off factor
 - DM 125
 - Root raised cosine filter
 - see Root Cosine 142
 - Rotary knob 45
 - User variation 265, 270
 - RRC filter
 - see Root Cosine filter 142
 - RS232
 - Baud rate 536
 - Parity 536
 - Serial interface 536
 - Stop bits 537
- S**
- S-Parameter
 - Activate corrections 373
 - Safety instructions 26
 - SAMBA/SMB
 - How to access the instrument 468
 - Sample level
 - ALC 352
 - Automatic level control 352
 - Sample rate
 - Aggregated 432
 - Channel 432
 - Link 432
 - Source 429, 433
 - Value 434
 - Where to find the value 410
 - Samples
 - Blank segment 178
 - Samples per period 155
 - Sanitize 510
 - Save
 - Control list 134
 - Editor 316, 359
 - Instrument settings 455
 - Sequencing list 183
 - Save and load 451
 - Save as
 - Editor 316, 359
 - Save hard copy as
 - bmp, jpg, png 476
 - Save immediate 455
 - Save instrument settings 584, 598
 - Save intermediate 584
 - Save list 175
 - Save/Recall 202, 451
 - Dialog 452
 - Digital standard 453
 - DM 118
 - Firmware option settings 453
 - How to 456
 - I/Q output analog 438
 - SCPI-Export 566
 - Saving
 - Trying out 64
 - Scan
 - NRP sensor mapping 366
 - Scan for
 - External RF and I/Q instrument 421
 - SCONfiguration subsystem 633
 - SCPI
 - Error messages 939
 - Export 461
 - Export settings 563
 - LAN services 514
 - Output file 563
 - Parameters 950
 - Syntax 948
 - Version 523
 - SCPI confirmed commands 946
 - SCPI export 563
 - Select file 563
 - Show file content 564
 - SCPI Export
 - Format 563
 - SCPI list
 - Commands of all settings 455
 - Display 562
 - Export 562
 - Recorded SCPI commands 562
 - Show all commands 454

SCPI remote trace		
LXI	545	
SCPI script		
Select	499	
SCPI-Export		
Save/Recall	566	
Screen saver		
Activate	485	
State	482	
Wait time	482	
Secure update policy		
All packages	508	
Confirm unsigned	508	
R&S signed packages	508	
Security		
Accept settings	515	
Change password (setup)	517	
Change user password (setup)	517	
Confirm password (setup)	517	
Confirm user password (setup)	516	
Display lock	511	
Enter password (setup)	514	
New password (setup)	517	
New user password (setup)	516	
Old password (setup)	517	
Old user password	516	
Password management	515	
Sanitize	510	
Secure update policy	508	
Security password	517	
Settings	507	
Setup	505	
USB storage (setup)	509	
User name (setup)	516	
User password	516	
Volatile memory	510	
Security password		
Security	517	
Setup	517	
Security settings	505	
Segment #	177	
Segment down	177, 178, 185	
Segment marker	180	
Segment up	177, 178, 185	
Select		
List mode data file	311	
Setup file	499	
User correction data file	356	
Select file	460	
Select instrument		
External RF and I/Q	422	
Self-test		
Remote	585	
Selftest		
ARB file (test generator)	932	
Connection selftest (BNC)	929	
Destination	929	
Execute (baseband)	930	
Frequency (test generator)	931	
Gain (test generator)	931	
Result	929	
Source	929	
Source (test generator)	931	
State (test generator)	931	
Selftests		
About	921	
Sensitive information		
Protecting	443, 451	
Sequencing graph	185	
Sequencing list	175, 183, 188	
Load	183	
New	183	
Sequential commands	955	
Serial bus	935	
Serial interface		
RS232	536	
Serial number	39, 48	
Power sensors	370	
Service manual	26	
Service request (SRQ)	962, 965	
Service request enable register (SRE)	962	
Remote	584	
Services		
LAN	513	
Set according to	118	
Set IDN and OPT to default		
Emulation mode	538	
Set noise level via	237	
Set to default	201	
ARB	152	
DM	118	
MCCW	217	
Set up remote control		
GPIB	556	
Setting commands	946	
Settings		
Active connections	538	
AM	328	
Appearance	483	
Attenuator	347	
Automatic level control	350	
Check front panel	924	
Display	481	
FM	325	
Instrument emulations	537	
Internal adjustments	927	
Keyboard	481	
List mode	308	
Local oscillator	281	
Managing	442	
NRP power viewer	368	
NRP sensor mapping	366	
On power-on	484	
PhiM	326	
Protection	506	
Remote access	531	
RF level	266	
SCPI export	563	
Security	507	
UCOR	355	
Undo/Redo	518	
Setup		
Accept security settings	515	
Adjusting display	480	
Adjusting keyboard	480	
Annotation frequency	511	
Annotation level	511	
Appearance settings	483	
Change password	517	
Change password (security)	517	
Confirm password	516	
Confirm password (security)	517	
Display lock	511	

- Enter password (security) 514
- GUI update 480
- Keyboard settings 481
- Layout (keyboard) 483
- New password 516
- New password (security) 517
- Old password (security) 517
- Password (protection) 507
- Performing the front panel test 925
- Protection level 507
- Screen saver 482
- Secure update policy 508
- Security password 517
- Test (touchscreen) 925
- USB storage (security) 509
- User name (security) 516
- User password 516
- Wait time 482
- Setup files
 - Data exchange 473
- Setup key 480
- Shape
 - LF generator 337
 - LF output 337
 - Period 338
 - Pulse duty cycle 338
 - Pulse width 338
 - Sweep 303
 - Trapeze high 339
 - Trapezoid rise, fall 339
 - Triangle rise 338
- Shared connectors
 - Global connectors 487
- Shifting the baseband signal 224
- Shortcut to a network drives
 - How to 466
- Show
 - SCPI list 454
- Show file content
 - SCPI export 564
- Show powers for output
 - AWGN 236
- Show SCPI command 561
 - Close 561
 - Copy 561
- Shutting down 33
- Signal + Interferer
 - PEP 240
- Signal + Noise
 - PEP 240
- Signal duration 204
- Signal generation status 111
- Signal monitoring
 - Graphical display 378
- Signal output
 - LF 341
- Signal period mode 203
- Signal power 238
- Signal source
 - Analog modulation 319
- Signal to connector mapping
 - How to 495
- Signal/Noise ratio 237
- Simultaneous signal generation start
 - Several instruments 401
- Sine test signal 146
- Sine test signals
 - Settings 154
- Single
 - Common settings 110
 - Execute (list mode) 311
- Single sideband signal
 - Generation 222
- SMB (Samba)
 - LAN services 514
- Snapshots
 - Dialog 483
- Softkey bar
 - see Taskbar 77
- Software options 71
- Source
 - AM, FM, Φ M 325
 - Analog modulation 319
 - Connection selftest (BNC) 929
 - Graphics 387
 - Impedance 342
 - LF output 342, 344
 - Power ramp control 127
 - Power sensors 371
 - Pulse modulation 323
 - Reference oscillator 276
 - Sweep trigger 302
 - Test generator selftest 931
- Source points for graphic display 383
- Source subsystem
 - Remote control commands 647
- Spacing
 - Frequency sweep 304, 306
 - Level sweep 308
- Span
 - Frequency sweep 306
- Specified trigger delay 113
- Spectrum display 383
- SRE 960
- SRE (service request enable register) 962
- SRQ 975
- SRQ (service request) 962, 965
- SSB
 - Generation 222
- SSH
 - LAN services 514
- Standard 118
- Standard settings 201, 217
 - DM 118
- Standard-compliant signals 87
- Standby 33
 - Key 43
- Start
 - Frequency sweep 306
 - Level sweep 308
- Start delay 211
- Start phase 210
- Start/stop carrier index 210
- Starting 33
- Starting gain 210
- Starting the signal generation with the first sample 101
- State
 - Adjustment (reference oscillator) 279
 - AM, FM, Φ iM 325
 - ARB 151
 - Automatic level control 350
 - AWGN 234
 - BB Input 429

- Carrier (MCCW) 219
- DM 118
- I/Q modulation 253
- Impairments 247
- LF frequency sweep 301, 336
- List mode 309
- MCCW 216
- Power sensors 370
- Pulse generator output 333
- Pulse modulation 323
- RF frequency sweep 301
- RF level sweep 301
- RF output 261
- RF output protection 348
- Screen saver 482
- Test generator selftest 931
- UCOR 356
- Undo/Redo 518
- Status
 - Queries 965
 - Remote connection to external RF and I/Q 418
- Status bar
 - Display 75
- Status byte
 - Remote 581, 584
- Status byte (STB) 962
- Status information 503
- Status register
 - Response format definition 611
- Status registers 960
 - CONDition 961
 - ENABle 961
 - EVENT 961
 - model 961
 - NTRansition 961
 - parts 961
 - PTRansition 961
- Status reporting system 958
 - Application 965
 - Common commands 581
- Status settings
 - LXI 541
- STB 960
- Step
 - Frequency sweep 307
 - Linear (frequency sweep) 307
 - Logarithmic (frequency sweep) 307
 - Sweep 308
- Step width
 - User variation 265, 270
- Stop
 - Frequency sweep 306
 - Level sweep 308
- Stop bits
 - RS232 interface 537
- Storage location
 - /usb/ 442
 - /var/user 442
 - /var/volatile 442
 - Mass memory 587
- Store
 - Save 452
- Storing 920
- Storing files 588
- Stream distributing
 - Settings 414
- Stream mapping
 - Settings 414
- String in remote commands 952
- Subnet mask 534
- Subsystem
 - AM 660
 - FM 665
 - Keyboard 616
 - OUTPut 648
 - Phase 858
 - PM 670
 - Power 859
 - PULM 674
 - Pulse generator 857
 - SOURce:INPut 648
- Suffixes 949
- Sum signal
 - How to shift basebands 227
- Support 944
- Suppressing
 - Carrier leakage 227
- Surveillance
 - Signal generation 378
- Sweep
 - Center frequency 306
 - Current frequency 302
 - Current level 302
 - Dwell time 304
 - Execute single 305
 - Frequency span 306
 - Mode 302
 - Reset 305
 - Retrace 303
 - Shape 303
 - Spacing 304, 306, 308
 - Start/stop frequency 306
 - Start/stop level 308
 - State (LF frequency) 301, 336
 - State (RF frequency) 301
 - State (RF level) 301
 - Step 307, 308
 - Trigger manually 305
- Switch over
 - Flexible 191
 - High speed 192
- Switching
 - Modulation to CW 124
- Symbol rate
 - DM 119
- Symbolic name
 - External RF and I/Q 422
- Sync. output to trigger 112
- Synchronization
 - Assign signal 401
 - Mode 401
 - State 400
 - Sync signal state 401
- Synchronization bandwidth
 - Reference oscillator 277
- Synchronize
 - External RF and I/Q instrument 419
- Synchronizing
 - Several instruments 399
 - Signal generation 405
- Synchronizing instruments
 - How to 398
- Synchronous generation start 97

- Syntax elements
 - SCPI 952
- System
 - Factory preset 448
- System bandwidth
 - AWGN 235
 - Noise level (absolute) 343
 - Noise level (relative) 343
- T**
- Tab labels 78
- Tag type 760
 - Clock 752
 - Comment 752
 - Control length 755
 - Control list width4 761
 - Copyright 753
 - Data bit length 753
 - Data list 753
 - Date 754
 - Emptytag length 754
 - Level offset 756
 - Magic 751
 - Samples 757
 - Segment clock mode 760
 - Segment comment 761
 - Segment count 759
 - Segment files 761
 - Segment length 759
 - Segment level offset 760
 - Segment start 759
 - Trace list 757
 - Waveform length 758
- Tapping points 383
- Target crest factor 203
- TD-SCDMA 88
- Temperature offset
 - Internal adjustments 928
- Temporary files 443, 451
- Test
 - Check front panel 925
- Test signal
 - Amplitude of test signal 156
 - ARB generator 146
 - Frequency 155, 156
 - Offset DC 157
 - Phase offset Q 155
 - Samples per period 155, 156
 - Value I, Q 158
- Testing
 - High power amplifiers 212
- Text entry 80
- Text paramters in remote commands 952
- Threshold
 - Pulse modulation 495
- Time
 - UTC 923
- Timeout
 - Filter (power sensors) 372
- Tooltips
 - Show 82
- Total depth
 - FM 326, 327, 329
 - Frequency modulation 326, 327, 329
- Touchscreen
 - Compared with mouse 74
 - Overview 41
 - Test 925
 - Usage 74
- Touchscreen test
 - Perform 926
- Trace
 - Enable in graphic 390
- Tracking
 - Signal parameter 378
- Transition
 - PULM 323
 - Pulse modulation 323
- Transmitter test
 - Generating multi carrier signal 212
- Trapezoid
 - High (LF generator) 339
 - Rise, fall 339
- Triangle
 - Rise 338
- Trigger
 - Event (remote) 584
 - Execute (list mode) 311
 - Generate signal manually 493
 - Manual execute 494
 - Manually 493
 - Sweep, manually 305
- Trigger box 405
- Trigger delay
 - Actual 113
 - Expressed in seconds 113
 - Expressed in time 112
 - Resulting 113
 - Unit 112
- Trigger Delay
 - DM 113
- Trigger event 97
 - Delay 101
 - Suppress 101
- Trigger example 189
- Trigger Mode
 - Common settings 110
- Trigger signal duration 111
- Trigger signals
 - Baseband 96
- Trigger source
 - Graphics 387
 - List mode 309
 - Sweep 302
- Trigger Source
 - DM 111
- Trigger, accidental
 - Avoiding 101
- Triggering
 - Multi-segment waveform 170
 - Segment 170
- Triggering synchronous 405
- Tripped
 - RF output protection 348
- TS-USB1
 - USB adapter 536
- Turn on 32

U

UCOR	
About	353
Data	356
Display correction value	356
Edit data	356
Export user data	313, 363
File catalog	356
File settings, import/export	313, 362
Fill with sensor	360
Import/export	312, 362
Load from file	313, 362
RF signal	352
Select file	356
Settings	355
State	356
Values, defining	315, 358
Undo	517
Clear history	518
History	518
Settings	518
State	518
Units X-axis	
Change	390
Unmodulated signal	92
UP	951
Up-conversion	
Important parameters	409
USB	
Adapter TS-USB1	536
Interfaces	526
Storage (security)	509
Use default aperture time	
Power sensors	373
User clock	180
User correction	
see UCOR	352
User data	
Access	457
Load from a specific directory	589
User files	442
User filter	
Catalog	126
Delete	126
User interface	
Lock	511
User key	
Action name	499
Add, change, delete action	500
Define action	499, 500
SCPI command	500
Select dialog ID	499
Toggle between define and execute mode	500
User manual	25
User mapping	
Catalog	123
Delete	123
User name	
Setup (security)	516
User password	
Security	516
Setup	516
User preset	447

User variation	
Activating	265, 270
Level	265, 270
RF	265, 270
User-definable preset	
Recall	497
Utility keys	
Overview	43

V

Variable FSK	
Deviation	124
Selecting	123
Variable reference frequency	277
Varying	
RF frequency and level	265, 270
Vector diagram	379
Vector modulation	251, 252
Verifying	
Signal parameter	378
Version	
Firmware	936
Vertical stroke	952
Video polarity	
Pulse modulation	323
VISA	523
Libraries	528
Resource string	523
Visa resource string	
Ethernet	535
GPIB	535
HISLIP	535
Serial	535
Socket	535
USB	535
Visa resource strings	535
VNC	
LAN services	514
Using in a LAN	84
Volatile memory	443, 451
Volatile mode	
Activate	510
VXI protocol	525

W

Wait	
Remote	585
Wait time	
Screen saver	482
Wanted signal	
Use an external digital signal	408
Warnings	938, 941
Waveform	
Edit, rules	770
Info	152, 177
Load file	152
Maximum length	149
Optimizing	148
Waveform file	
Corrupted, reasons	770
White papers	27
White space	952
Wi-Fi	
WLAN	572

Width	
Double pulse (PULM)	333
PULM	332
Pulse modulation	332
Wireless LAN standards	88
WLAN standards	88
Workflow	
Multi-segment waveform	189
Workgroup name	533
Wrap-around	
Avoiding problems	199
Overcome problem	191

Z

Zero	
Power Sensors	370
Zeroconf	
IP address	943
Zeroconf (APIPA) protocol	39
Zoom	
Control list display	133
Zoom In/Out	
Pulse graph	334
Zoom position	
Pulse graph	334
Zooming	
Pulse graph	334



北京海洋兴业科技股份有限公司 (证券代码: 839145)

北京市西三旗东黄平路19号龙旗广场4号楼 (E座) 906室

电话: 010-62176775 62178811 62176785

企业QQ: 800057747 维修QQ: 508005118

企业官网: www.hyxyyq.com

邮编: 100096

传真: 010-62176619

邮箱: market@oitek.com.cn

购线网: www.gooxian.com



扫描二维码关注我们

查找微信公众号: 海洋仪器