

F 62 - F 65

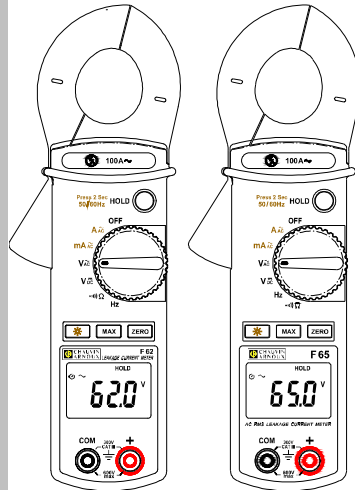

TABLE OF CONTENTS

1.	GENERAL INSTRUCTIONS	20
1.1.	Precautions and safety measures.....	20
1.1.1.	Before use.....	20
1.1.2.	Measurement categories	20
1.1.3.	While in use	22
1.1.4.	Symbols	22
1.1.5.	Instructions.....	22
1.1.6.	Maintenance.....	22
1.2.	Warranty	23
1.3.	Maintenance	23
1.4.	Unpacking - Repacking.....	23
2.	DESCRIPTION OF THE INSTRUMENT	24
2.1.	Description of the front and rear panels.....	24
2.2.	Description of the display unit	25
3.	GENERAL DESCRIPTION.....	26
3.1.	Preparation for use	26
3.1.1.	Power supply.....	26
3.1.2.	Installation and replacement of the batteries.....	26
3.2.	Automatic ranges.....	26
3.3.	MAXIMUM value (MAX)	26
3.4.	Hold mode (HOLD)	27
3.5.	Relative values (ZERO)	27
3.6.	50-60Hz filter.....	27
3.7.	Automatic shut-off (instrument).....	27
3.8.	Backlighting	27
4.	FUNCTIONAL DESCRIPTION	28
4.1.	Alternating current measurement (A range).....	28
4.2.	Leakage current measurement (mA range).....	29
4.3.	AC and DC voltage measurements	30
4.4.	Resistance measurement	30
4.5.	Audible continuity test	31
4.6.	Frequency measurement (Hz)	32
5.	SPECIFICATIONS	33
5.1.	General	33
5.2.	Characteristics	33
5.2.1.	AC current (automatic ranges).....	33
5.2.2.	mAC current (automatic ranges).....	33
5.2.3.	AC voltage (automatic ranges)	33
5.2.4.	DC voltage (automatic ranges)	33
5.2.5.	Resistance (Ω) and continuity.....	34
5.2.6.	Frequency (automatic ranges)	34
5.2.7.	Safety	34
5.2.8.	General information	34
5.3.	Environment.....	35
5.3.1.	Temperature	35
5.3.2.	EMC	35
5.4.	To order	35

1. GENERAL INSTRUCTIONS

1.1. Precautions and safety measures

1.1.1. Before use

You have just bought a clamp-on leakage meter. Thank you for your confidence.

This clamp-on meter complies with the IEC 61010 safety standard for electronic measuring instruments. For your own safety, and that of the instrument, it is best to follow the instructions given in this manual.

- * This instrument can be used for measurements on circuits in installation category III, in a pollution level 2 environment, with voltages not exceeding 300V with respect to ground.

1.1.2. Measurement categories (EN 61010-2-032, EN 61010-2-033):

MEASUREMENT CATEGORY II

MEASUREMENT CATEGORY II is applicable to test and measuring circuits connected directly to utilization points (socket outlets and similar points) of the low-voltage MAINS installation. This part of the installation is expected to have a minimum of two levels of overcurrent protective devices between the transformer and the connecting points of the measuring circuit.

Example: measurements on MAINS CIRCUITS of household appliances, portable tools and similar equipment.

MEASUREMENT CATEGORY III

MEASUREMENT CATEGORY III is applicable to test and measuring circuits connected to the distribution part of the building's low-voltage MAINS installation. This part of the installation is expected to have a minimum of one level of over-current protective devices between the transformer and possible connecting points.

Example: measurements on distribution boards (including secondary electricity meters), circuit breakers, wiring, including cables, bus-bars, junction boxes, switches, socket -outlets in the fixed installation, and equipment for industrial use and some other equipment such as stationary motors with permanent connection to the fixed installation.

MEASUREMENT CATEGORY IV

MEASUREMENT CATEGORY IV is applicable to test and measuring circuits connected at the source of the building's low-voltage MAINS installation. This part of the installation could have no over-current protective devices between the transformer and connecting points of the measuring circuit.

Example: measurements on devices installed before the main fuse or circuit breaker in the building installation.

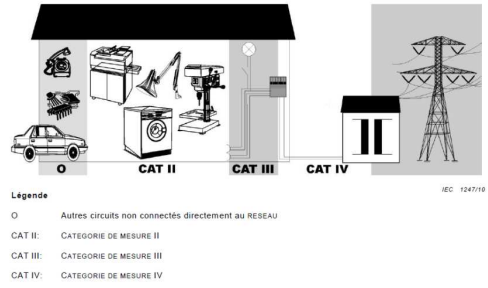

For your safety, use only cords complying with the IEC 61010 standard. Before each use, check that they are in perfect working condition.

1.1.3. While in use

- Never exceed the maximum safe values indicated in the specifications for each type of measurement.
- When the clamp-on meter is connected to the measuring circuits, do not touch any unused terminal.
- Before changing functions, disconnect the measuring cords from the circuit being measured.
- Never perform resistance measurements on a live circuit.

1.1.4. Symbols



Refer to the operating manual



Risk of electric shock



Double insulation

1.1.5. Instructions

- **Before opening the instrument,** you must disconnect it from the measuring circuits and check that you are not charged with static electricity, which could destroy internal components.
- A "**qualified person**" is someone familiar with the installation, construction, use, and hazards. He/she is authorized to start up and shut down the installation and equipment, in conformity with the safety rules.

1.1.6. Maintenance

Clean the instrument with a damp cloth and soap. Do not use abrasive substances or solvents.

1.2. Warranty

This equipment is warranted against defects in materials and workmanship, in conformity with the general conditions of sale.

During the warranty period, the instrument may be repaired only by the maker, who shall be free to decide whether to repair or to replace all or part of the instrument. If the equipment is returned to the maker, the cost of transport to the maker's is borne by the customer.

The warranty does not cover the following cases:

1. improper use of the hardware or use in association with incompatible equipment;
2. modification of the equipment without the explicit authorization of the maker's technical staff;
3. work done by a person not approved by the maker;
4. adaptation to a particular application not anticipated in the definition of the equipment or in the operating instructions;
 1. impact, fall, or flood.

The contents of this manual may not be reproduced in any form without our permission.

Note: warranty does not cover the magnetic head gap.

1.3. Maintenance

For checking and calibration, contact one of our accredited metrology laboratories (information and contact details available on request), at our Chauvin Arnoux subsidiary or the branch in your country.

1.4. Unpacking - Repacking

All of the equipment has been checked mechanically and electrically before shipping. Every precaution has been taken to ensure that the instrument reaches you undamaged. It is wise to check it promptly in order to detect any deterioration that may have occurred during transport. If any deterioration is found, state your reservations to the carrier.

Attention! For reshipment, it is best to use the original packaging and state the reasons for returning the equipment as clearly as possible in a note enclosed with it.

2. DESCRIPTION OF THE INSTRUMENT



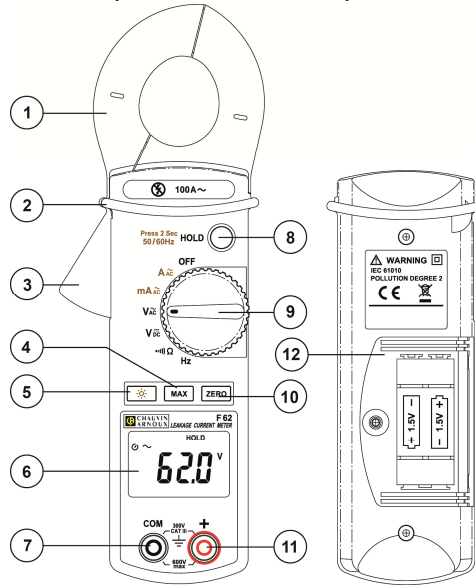

2.1. Description of the front and rear panels

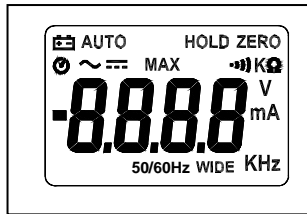

- 1 Jaws
- 2 Protective guard
- 3 Trigger
- 4 MAX function
- 5 Backlighting function
- 6 Display unit
- 7 COM input terminals
- 8 HOLD function / 50-60Hz filter
- 9 Switch
- 10 Display reset (zero) key
- 11 + Input terminals
- 12 Battery well

2.2. Description of the display unit



	Batteries low
AUTO	Automatic range
MAX	Maximum value display
HOLD	Hold mode display
ZERO	Relative Measurement displayed
	Continuity measurement
V	Voltage measurement
A	Current measurement
...Hz	Frequency measurement
50-60 Hz	Fundamental filter active
WIDE	Measurement over whole pass band
	Automatic shut-off activated
	Alternating current / voltage

3. GENERAL DESCRIPTION

3.1. Preparation for use

3.1.1. Power supply

Batteries: AAA or LR03, 1.5 V (two)

Battery life: 45 hours (alkaline batteries).

3.1.2. Installation and replacement of the batteries

1.  is displayed when the voltage delivered by the batteries is below the operating voltage.
2. Before replacing the batteries, set the switch to "OFF", disconnect the measuring cords, and disconnect the clamp from the circuit being measured.
3. Loosen the screw and open the cover of the battery compartment with a screwdriver.
4. Replace the used batteries with two new 1.5V LR03 batteries.
5. Put the cover back in place and tighten the attachment screw.

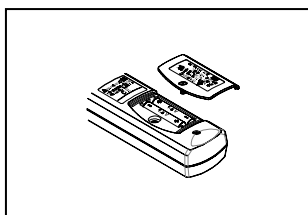

3.2. Automatic ranges

Range selection is automatic for all functions. The AUTO symbol on the display indicates this operating mode.

3.3. MAXIMUM value (MAX)

In the AC current and AC&DC voltage measurement modes, the largest value can be measured simply by pressing the "MAX" button. The MAX symbol then appears on the screen.

The acquisition time is 100ms.

To deactivate this function, press the "MAX" button again.

3.4. Hold mode (HOLD)

The value displayed can be frozen simply by pressing the "HOLD" button. The "HOLD" symbol is then displayed on the screen. To deactivate this function, press the "HOLD" button again.

3.5. Relative values (ZERO)

It is possible to compare two values, in any function except frequency measurement, simply by pressing the "ZERO" button.

When the first value is displayed on the screen, press the ZERO buttons.

The ZERO symbol then appears on the screen and the display unit indicates the value zero.

Make your second measurement. The display unit then indicates the difference between the second value and the first value.

To deactivate this function, press the "ZERO" button again.

This function can be used to compare two voltage measurements (e.g. to determine a voltage drop) or to correct for the resistance of the cords when making a resistance measurement.

3.6. 50-60Hz filter

It is possible to filter the signal (when making a current measurement), in order to display only the fundamental, by a long press on the "HOLD" button.

The 50/60Hz symbol then appears on the screen.

To deactivate this function and return to measuring over the whole passband of the instrument, effect another long press on the "50-60Hz" button.

The WIDE symbol then appears on the screen.

3.7. Automatic shut-off (instrument)

The clamp is shut off automatically after 10 minutes if no operation is performed. The symbol indicates that the automatic shut-off mode is activated.

To deactivate automatic shut-off, hold the "ZERO" button down and operate the switch.

The symbol disappears from the display unit, indicating that automatic shut-off is deactivated.

3.8. Backlighting

Pressing the key activates backlighting of the display. The backlighting can be switched off manually by pressing the key; otherwise, it is switched off automatically after 180 seconds.

4. FUNCTIONAL DESCRIPTION

4.1. Alternating current measurement (A range)

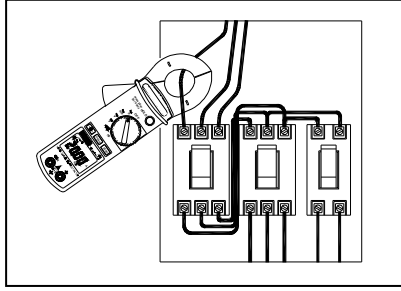

Set the switch to A~.

Open the clamp by pressing the trigger. Place the clamp around the conductor to be measured and release the trigger; check that the clamp is properly closed. Read the measurement on the display unit.

Note: As a safety measure, disconnect the measuring cords from the clamp before performing this operation. The clamp must be placed around a single conductor of a circuit, since otherwise the measurement may be thrown off. The measurement is optimal with the conductor centred in the middle of the jaws.

4.2. Leakage current measurement (mA range)

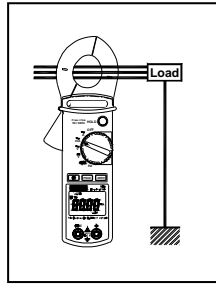

Note: As a safety measure, disconnect the measuring cords from the clamp before performing this operation. The measurement is optimal with the conductor centred in the middle of the jaws.

Set the switch to mA~.
Open the clamp by pressing the trigger.

Place the clamp around the active conductors (Phase conductors and Neutral) and release the trigger; check that the clamp is properly closed. Read the measurement on the display unit.

The reading can be filtered to reflect only the fundamental by a long press on the HOLD key, giving an indication of the impact of the harmonics.

4.3. AC and DC voltage measurements

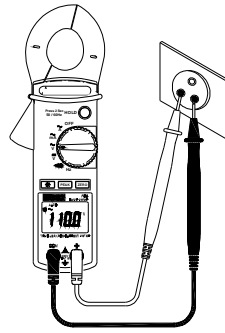

Set the switch to V~ for an AC voltage measurement and to V= for a DC voltage measurement.

Connect the red test cord to the "+" input terminal and the black test cord to the "COM" input terminal.

Then place the probe tips in contact with the points where the AC voltage is to be measured.

Read the result on the display unit.

4.4. Resistance measurement

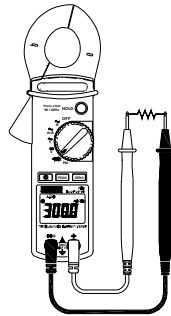

Set the switch to Ω .

Connect the red test cord to the "+" input terminal and the black test cord to the "COM" input terminal.

Place the probe tips in contact with the points to be measured and read the result on the display unit.

Note: Before making a measurement on a circuit, check that it is Off and that ANY capacitors are discharged.

4.5. Audible continuity test

Set the switch to Ω .

Connect the red test cord to the "+" terminal and the black test cord to the "COM" terminal.

Place the probe tips in contact with the circuit to be tested.

If the resistance is less than 35Ω , the buzzer will sound continuously.

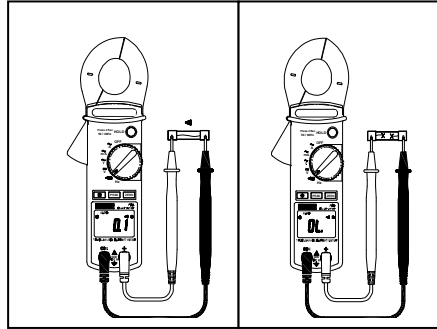

4.6. Frequency measurement (Hz)

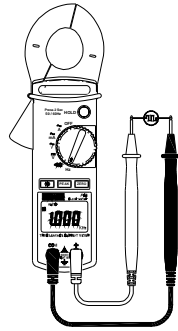

Set the switch to Hz for a frequency measurement in AC voltage mode.

Connect the red test cord to the "+" input terminal and the black test cord to the "COM" input terminal.

Then place the probe tips in contact with the points where the AC voltage is to be measured.

Read the result on the display unit.

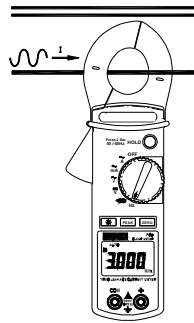

Disconnect the probe tip cords from the clamp-on meter.

Set the switch to Hz for a frequency measurement in AC current mode.

Open the clamp by pressing the trigger.

Place the clamp around the active conductors (Phase conductors and Neutral) and release the trigger; check that the clamp is properly closed. Read the measurement result on the display unit.

Note: The frequency measurement cannot be made if the clamp-on meter detects both a current measurement and a voltage measurement.

5. SPECIFICATIONS

5.1. General

Only values with tolerances or stated limits are guaranteed. Values without tolerances are stated for information only.

5.2. Characteristics

The precision is \pm [% of reading (L) + number of representation units (digits or D)] under the reference conditions (see Appendix).

5.2.1. AC current (automatic ranges)

Ranges	Resolution	Accuracy
10A	1mA	1.2% \pm 5cts(50~60Hz) 2.5% \pm 5cts(60~500Hz)
80A	10mA	F 65 : 3.5% \pm 10cts (500~3kHz)
80~100A	10mA	5% \pm 5 cts (50~60Hz)

Overload protection: 150 A_{rms}

F65: RMS measurement (Rooth Mean Square value)

5.2.2. mA AC current (automatic ranges)

Ranges	Resolution	Accuracy
60mA	10 μ A	1.2% \pm 5cts(50~60Hz) 2.5% \pm 5cts(60~500Hz)
600mA	100 μ A	F 65 : 3.5% \pm 10cts (500~3kHz)

Overload protection: 150 A_{rms}

F65: RMS measurement (Rooth Mean Square value)

5.2.3. AC voltage (automatic ranges)

Ranges	Resolution	Accuracy
600V	0.1V	1.0% \pm 5cts (50~60Hz) 1.2% \pm 5cts (60~500Hz) F 65 : 2.5% \pm 5cts (500~3kHz)

Input impedance: 1 M Ω

Overload protection: 660 Vrms

F65: RMS measurement (Rooth Mean Square value)

5.2.4. DC voltage (automatic ranges)

Ranges	Resolution	Accuracy
600V	0.1V	1.0% \pm 2cts

Input impedance: 1 M Ω

Overload protection: 660 Vrms

F65: RMS measurement (Rooth Mean Square value)

5.2.5. Resistance (Ω) and continuity

Range	Resolution	Accuracy
1k Ω 	0.1 Ω	1%+3

Max. voltage: 3.3V DC during the measurement.
 Overload protection: 660 Vrms
 Continuity selection threshold: $R < 35 \Omega$

5.2.6. Frequency (automatic ranges)

Function	Ranges	Resolution	Accuracy
A-Hz	0-100 Hz	0.1Hz	0.5%±2cts
A-Hz	100-1 kHz	1Hz	
V-Hz	0-100 Hz	0.1Hz	0.5%±2cts
V-Hz	100-1 kHz	1Hz	

Frequency measurement for currents greater than 10 mA RMS.
 Frequency measurement for voltages greater than 5 V RMS.

5.2.7. Safety

IEC 61010-1, IEC 61010-2-032 and IEC 61010-2-033:

- Insulation: class III
- Pollution level: 2
- Altitude < 2000 m
- Installation category: CAT III 300V

5.2.8. General information

Digital display unit

4 LCD digits with max. reading of 9,999 points

Overload

If a reading overshoots the range, the  symbol is displayed.

Battery Low indicator

 is displayed when the voltage delivered by the battery is less than the operating voltage.

Sampling

2 measurements/s for the digital display, 100ms for the MAX function.

Degree of protection of the enclosure

IP 30 as per NF EN 60529

Maximum opening of jaws

Ø 28 mm

Dimensions

(L x l x H): 218 x 64 x 30 mm

Weight

280 g (with batteries)

5.3. Environment

5.3.1. Temperature

Operation: 0°C to 40°C, < 80 % RH
Storage: -10°C to 60°C, < 70 % RH

5.3.2. EMC

Emissions and immunity in an industrial setting compliant with EN 61326-1.

5.4. To order

F62 P01120760
F65 P01120761

Instrument delivered in a box with:

1 operating manual
1 set of measuring cords (D4mm, one black and one red)
2 1.5V AAA or LR3 batteries
1 carrying bag

Accessories and spare parts

Set of 2 silicon leads with D4mm plugs P01295454Z
P01295453Z
Set of 2 alligator clamps P01295457Z
2P+E socket tester P01101997Z
Carrying case 200x100x40 mm P01298065Z

APPENDIX: Reference conditions

Sine-wave signal:

- Frequency from 48 to 65Hz
- No DC component
Temperature 23°C ± 5°C, RH < 80%
External magnetic field < 40 A/m
No alternating magnetic field
Conductor being measured centred (in A)
Specifications given for values from 5 to 100% of each range.

Note:

For a crest factor CF between 1.4 and 3 at full scale, add 1% to these specifications.