





# C.A 1725

# C.A 1727



Meanings of the symbols used on the device

	<b>WARNING, DANGER!</b> Refer to the user manual whenever you see this symbol.
	This marking certifies compliance with the European "Low Voltage" and "Electromagnetic Compatibility" directives (73/23/CEE and 89/336/CEE).
	In the European Union, this product is subject to sorting for the recycling of electrical and electronic equipment in accordance with WEEE directive 2002/96/EC.

You have just purchased a **C.A 1725 / C.A 1727 Tachometer**, thank you for your confidence.

For best results from your instrument :

- **Read** these quick start manual carefully.
- **Observe** the precautions for use.

## PRECAUTIONS FOR USE

### **For measurements without mechanical contact :**

Before using the tachometer, check that the front sighting window is perfectly clean.

The minimum detection distance is 1cm; but take care to avoid the immediate vicinity of any moving part, which might be dangerous for the operator and for the device.

### **For measurements with mechanical contact :**

Keep your hands as far as possible from the moving part.

Do not press too hard, since this might brake the moving part and result in an erroneous measurement.

For measurements on shaft ends, position the device as close as possible to the axis of the shaft.

### **For measurements using an external input :**

The use of the external connector requires observance of the rules concerning the interconnection of counting devices and industrial interference.

Use shielded wires connected to an earth that is not exposed to the switching transients of power systems.

The received interference must not exceed the amplitude of the hysteresis fixed in the device (250mV).

The external input is limited to a common mode of not more than 50 volts.

### **ATTENTION :**

The external sensor connector uses the same earth as the USB digital output

## CONTENTS

---

<b>1. INTRODUCTION .....</b>	<b>13</b>
<b>2. DESCRIPTION .....</b>	<b>13</b>
2.1 TACHOMETER .....	13
2.2 DISPLAY UNIT .....	16
<b>3. USE .....</b>	<b>18</b>
3.1 CONTACT-FREE MEASUREMENTS .....	18
3.2 MEASUREMENTS WITH CONTACT .....	18
3.3 MEASUREMENTS WITH EXTERNAL INPUT .....	19

# 1. INTRODUCTION

C.A 1725 and C.A 1727 tachometers, specially designed for industrial applications, measure the speed of rotation of any moving part at a distance or by contact.

CHAUVIN ARNOUX tachometers provide many possibilities in addition to the usual functions:

- Direct reading of the measurement
- Measurement of period, of frequency, of duty cycle, of linear speed
- Measurement by external sensor
- Special functions: smooth, range, hold, etc.
- Dual display: 100,000-point digital and bargraph.
- The C.A 1727 can be parameterized and has a USB link; associated with its specific software, it provides an extensive range of measurement, acquisition, processing, and data analysis possibilities.

# 2. DESCRIPTION

## 2.1 TACHOMETER

1 Optical sensor

2  key

- Store last digital value displayed.
- Disable automatic stop.

 key on the C.A 1727 only :

- For programming : shift the selection of the active digit or of the decimal point to the right.

3  key

- Smooth the measurements.

 key on the C.A 1727 only :

- For programming : increment the active digit.

4  key on the C.A 1727 only :

- Activate the audible and visual alarms.
- Program the alarm thresholds.

5  key on the C.A 1727 only :

- Command recording of the measurements in memory.







 key on the C.A 1727 only :

- Program the rate at which the measurements are recorded in memory.

6 USB output connector, on the C.A 1727 only.

7 Connector for external input.

8 Rotary switch.

- 9  key on the C.A 1727 only :
- Programming.
  - Initialize the program memory.
- 10  key on the C.A 1727 only :
- Event counter.
-  key on the C.A 1727 only :
- Program the scale factor : coefficient K.
- 11  key
- Manual or automatic change of range.
  - Extend the measurement range at low frequency.
-  key on the C.A 1727 only :
- For programming : decrement the digit.
- 12  key
- Record minima and maxima.
  - Disable the buzzer.
-  key on the C.A 1727 only :
- For programming : shift the selection of the active digit or of the decimal point to the left.

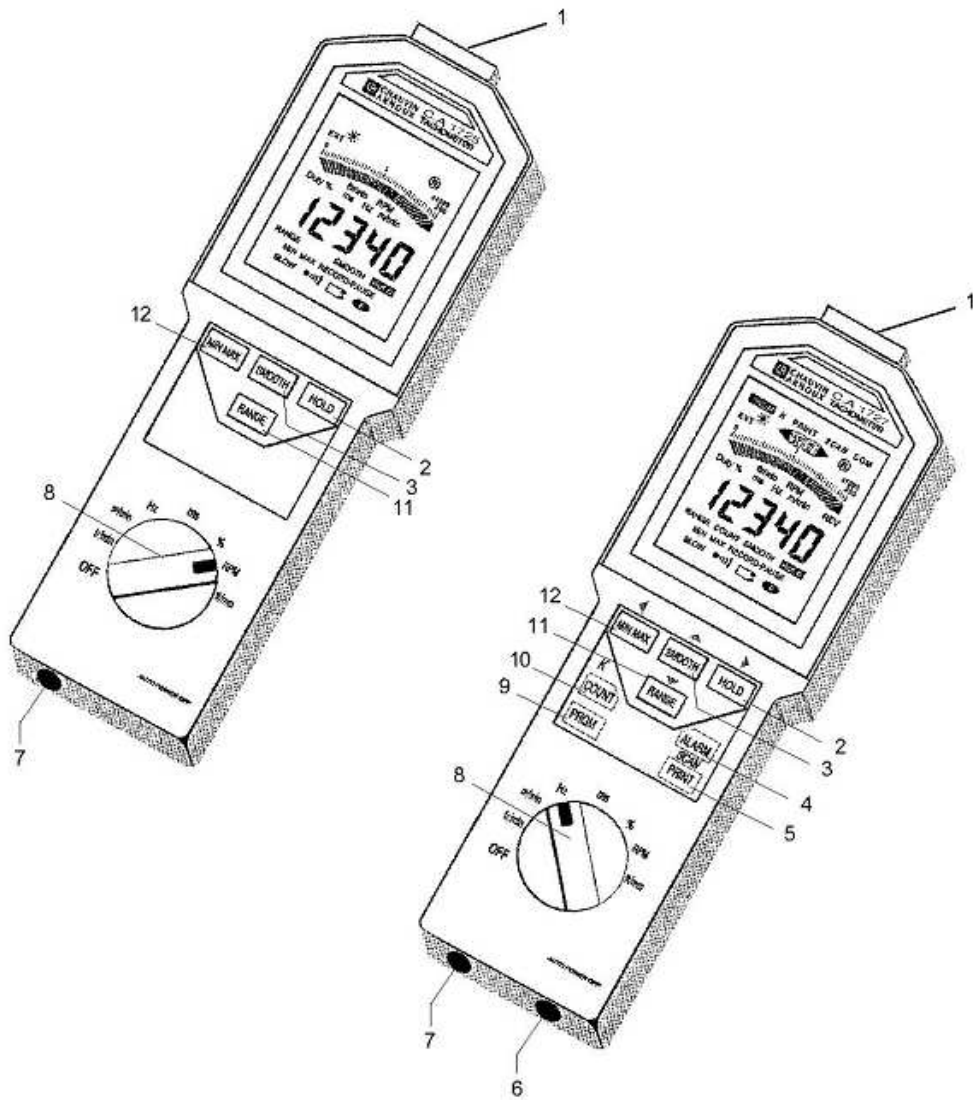

## 2.2 DISPLAY UNIT

- 1 Programming mode, on the C.A 1727 only.
- 2 Low threshold crossed, on the C.A 1727 only.
- 3 Full-scale coefficient K, on the C.A 1727 only.
- 4 Low threshold function, on the C.A 1727 only.
- 5 Memory write function, on the C.A 1727 only.
- 6 High threshold function, on the C.A 1727 only.
- 7 High threshold crossed, on the C.A 1727 only.
- 8 Rate of recording of measurements function, on the C.A 1727 only.
- 9 Transmission or reception in progress, on the C.A 1727 only.
- 10 Flashing indicator of operation of the infrared sensor.
- 11 Full-scale value of the bargraph (from 2 to 200 x 1000).
- 12 Analogue display by bargraph.
- 13 Arrowhead(s) indicating overshoot of end of scale.
- 14 Speed of rotation - Revolutions per minute
- 15 Revolutions: count of number of revolutions, on the C.A 1727 only.
- 16 metres per minute: linear speed.
- 17 Hertz: frequency.
- 18 Digital display, 5 digits.
- 19 Measurements in smoothed values.
- 20 Frozen display of the last measurement.
- 21 Recording paused.
- 22 Device in permanent operation.
- 23 Battery charge indicator.
- 24 MIN/MAX recording.
- 25 Buzzer active indicator.
- 26 Reading of MAX memory.
- 27 Measurement range extended to 0.1 Hz.
- 28 Reading of MIN memory.
- 29 Disable automatic change of range.
- 30 Counting function, on the C.A 1727 only.
- 31 Millisecond: period.
- 32 Duty cycle.
- 33 · ft/min: feet per minute - linear speed (in English).  
· tr/min: revolutions per minute - speed of rotation.
- 34 Graduated fixed scale.
- 35 Measurement by external connector.
- 36 Optical transmitter in action.

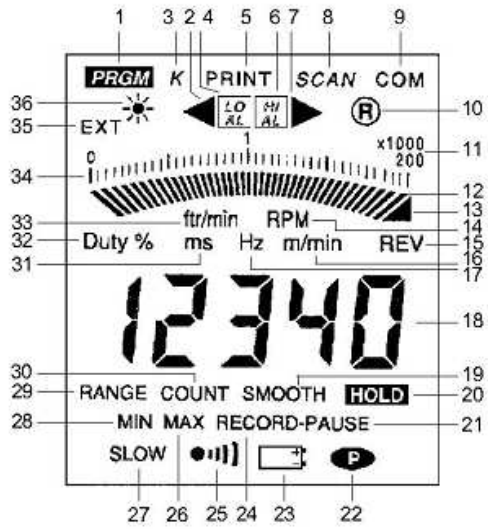



## 3. USE

### 3.1 CONTACT-FREE MEASUREMENTS

The contact-free measurement is made by the optical sensor built into the device. This sensor, placed in the front of the device, comprises a frequency-modulated infrared transmitter.

Before making any measurement, it is necessary to prepare the revolving target of which the speed is to be determined.

Check that the surface sighted is free of spurious reflections that might be counted in addition to the pulses from the reflecting adhesive. Proceed as follows: before applying the adhesive used to make the measurement, turn the target and check that when it is sighted the reading remains at ---. If not, it will be necessary to cover the entire surface of the target with a mat black medium.

When the target is correct, apply a reflecting adhesive tape on it, along the longest available radius. On small targets, the area covered by the adhesive tape must be less than 50% of the total area of the rotating part.

Start the target turning, aim the front of the device at it, and check that the measurement OK symbol flashes regularly.

The distance between the sensor and the target must be between 1 and 50cm.

The measurement angle of 30° (15° on either side of the perpendicular to the target) is convenient for aiming purposes.

During measurements of low speeds, very small movements of the device may make the measurement unstable: if this happens, we recommend placing the device on a stable support. There is a nut on the underside of the device for attachment to a tripod or similar support.

### 3.2 MEASUREMENTS WITH CONTACT

The mechanical adapter and its 3 end fittings allow measurement by contact on a shaft end or on a surface in linear motion.

It is placed in front of the sighting window of the optical sensor and accepts one of the following 3 end fittings:

- An elastomer cone with a tip that can be used for shaft end measurements (minimum diameter: 5mm).
- An elastomer cylinder that can be used for measurements on shafts with flat ends or shafts smaller than 5mm.
- An elastomer wheel for linear speed measurements (1 revolution of the wheel = 0.1m).

The end fitting must be pressed against the moving part just hard enough to drive it without slippage.

The adapter is attached to the front of the tachometer housing, in front of the sighting window. It automatically locks in position when pushed home.

#### - Fitting

To attach the adapter, align the three lugs on the inside of the adapter with the three recesses of the sighting window of the housing and turn anticlockwise.

#### - Removal

To remove it, pull the adapter outward until the locking tabs are clear, then turn clockwise.

### 3.3 MEASUREMENTS WITH EXTERNAL INPUT

The device has a 4-contact connector that can be used to connect an external source of which you wish to measure the speed, the frequency, the period, the duty cycle, etc.

In order to inform the tachometer that the measurement is available on the external input, it is necessary to short-circuit contacts 1 and 4.

Operation using the external input is indicated on the display unit by the extinction of the transmission symbol  and the display of **EXT**.

#### Wiring

Connector of the tachometer  
seen from contact side

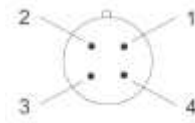

- 1- earth
- 2- measurement input ( $\pm 20V$  max.)
- 3- see below
- 4- to be short-circuited with contact no.1

Connecting 1 to contact 3 makes it possible to adapt the triggering threshold to the nature of the signals.

#### Contacts 1 and 3 not connected

For operation with 0 - 5V TTL signals.

The triggering threshold is +1.1V (at 1kHz).

To avoid the problems due to noise often present in an industrial environment, the threshold has a hysteresis of 250mV.

#### Contacts 1 and 3 connected

For operation with signals balanced with respect to earth.

This function allows direct measurement using a variable-reluctance magnetic sensor or the output of an alternator.

The triggering threshold is 300mV (at 1kHz), with a hysteresis of 250mV. The residual noise superimposed on the signal to be measured must be less than 250mV so as not to interfere with the measurement when the threshold is crossed.

#### ATTENTION :

The maximum voltage to input no. 2 must not exceed  $\pm 20V$ p. The earth of the external input connected is electrically connected to the earth of the USB digital output.